



**THE DATASHEET OF  
AUIPS71451G**



**CURRENT SENSE HIGH SIDE SWITCH**

**Features**

- Suitable for 24V systems
- Over current shutdown
- Over temperature shutdown
- Current sensing
- Active clamp
- Reverse circulation immunization
- Low quiescent current
- ESD protection
- Optimized Turn On/Off for EMI
- Lead-free, halogen-free, RoHS Compliant
- Automotive qualified

**Applications**

- Solenoid
- 24V loads for trucks

**Description**

The AUIPS71451G is a fully protected four terminal high side switch specifically designed for driving lamp. It features current sensing, over-current, over-temperature, ESD protection and drain to source active clamp. The Ifb pin is used for current sensing.

**Product Summary**

Rds(on)	100mΩ max.
Vclamp	65V
Current shutdown	4A min.

**Packages**

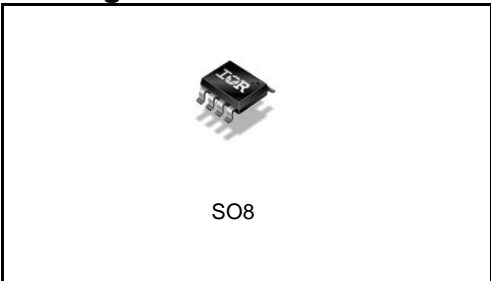

**Typical Connection**

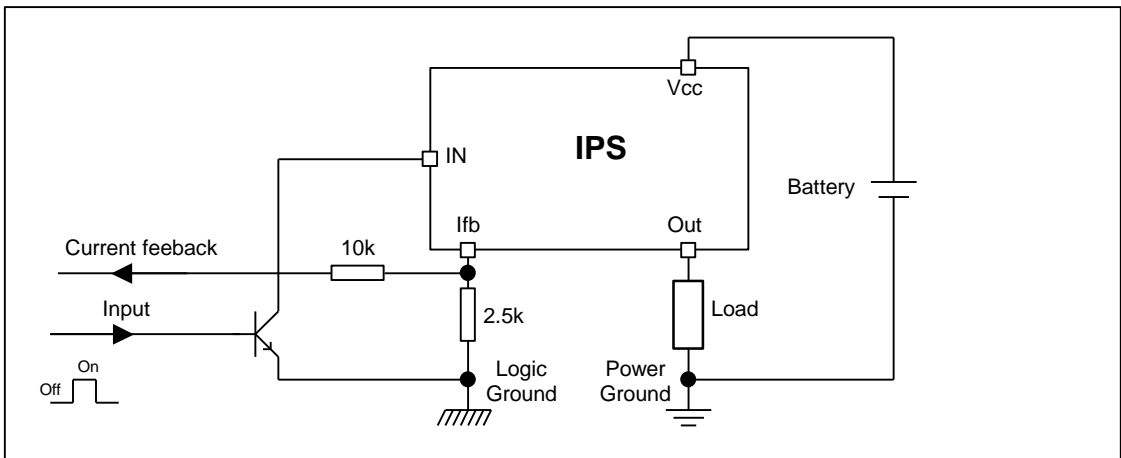

**Qualification Information<sup>†</sup>**

<b>Qualification Level</b>		Automotive (per AEC-Q100 <sup>††</sup> )	
		Comments: This family of ICs has passed an Automotive qualification. IR's Industrial and Consumer qualification level is granted by extension of the higher Automotive level.	
<b>Moisture Sensitivity Level</b>		SOIC-8L	MSL2, 260°C (per IPC/JEDEC J-STD-020)
<b>ESD</b>	Machine Model	Class M2 (200 V) (per AEC-Q100-003)	
	Human Body Model	Class H1C (1500 V) (per AEC-Q100-002)	
	Charged Device Model	Class C5 (1000 V) (per AEC-Q100-011)	
<b>IC Latch-Up Test</b>		ClassII, Level A (per AEC-Q100-004)	
<b>RoHS Compliant</b>		Yes	

† Qualification standards can be found at International Rectifier's web site <http://www.irf.com/>

†† Exceptions to AEC-Q100 requirements are noted in the qualification report.

## Absolute Maximum Ratings

Absolute maximum ratings indicate sustained limits beyond which damage to the device may occur. ( $T_j = -40^{\circ}\text{C}..150^{\circ}\text{C}$ ,  $V_{cc} = 6..50\text{V}$  unless otherwise specified).

Symbol	Parameter	Min.	Max.	Units
Vout	Maximum output voltage	$V_{cc}-60$	$V_{cc}+0.3$	V
I rev	Maximum reverse pulsed current ( $t=100\mu\text{s}$ ) see page 8	—	30	A
I <sub>sd</sub> cont.	Maximum diode continuous current $T_{\text{ambient}}=25^{\circ}\text{C}$ , $R_{\text{th}}=70^{\circ}\text{C/W}$	—	2.3	A
V <sub>cc</sub> -V <sub>in</sub> max.	Maximum V <sub>cc</sub> voltage	-16	60	V
I <sub>fb</sub> , max.	Maximum feedback current	-50	10	mA
V <sub>cc</sub> sc.	Maximum V <sub>cc</sub> voltage with short circuit protection see page 8	—	50	V
P <sub>d</sub>	Maximum power dissipation (internally limited by thermal protection) $R_{\text{th}}=100^{\circ}\text{C/W}$	—	1.25	W
T <sub>j</sub> max.	Max. storage & operating junction temperature	-40	150	$^{\circ}\text{C}$

## Thermal Characteristics

Symbol	Parameter	Typ.	Max.	Units
R <sub>th1</sub>	Thermal resistance junction to ambient SO8	100	—	$^{\circ}\text{C/W}$

## Recommended Operating Conditions

These values are given for a quick design.

Symbol	Parameter	Min.	Max.	Units
I <sub>out</sub>	Continuous output current, $T_{\text{ambient}}=85^{\circ}\text{C}$ , $T_j=125^{\circ}\text{C}$ $R_{\text{th}}=100^{\circ}\text{C/W}$	—	1.5	A
R <sub>fb</sub>	I <sub>fb</sub> resistor	1.5	—	k $\Omega$

## Static Electrical Characteristics

$T_j = -40^{\circ}\text{C}..150^{\circ}\text{C}$ ,  $V_{cc} = 6-50\text{V}$  (unless otherwise specified). Typical value are given for 28V and 25°C.

Symbol	Parameter	Min.	Typ.	Max.	Units	Test Conditions
Vcc op.	Operating voltage	6	—	60	V	
Rds(on)	ON state resistance $T_j = 25^{\circ}\text{C}$	—	75	100	mΩ	Ids=2A
	ON state resistance $T_j = 150^{\circ}\text{C}(2)$	—	135	180		
Icc off	Supply leakage current	—	1	3	μA	Vin=Vcc / Vifb=Vgnd Vout=Vgnd, $T_j = 25^{\circ}\text{C}$
Iout off	Output leakage current	—	1	3		
I in on	Input current while on	0.6	2	4	mA	Vcc-Vin=28V, $T_j = 25^{\circ}\text{C}$
V clamp1	Vcc to Vout clamp voltage 1	60	64	—		Id=10mA
V clamp2	Vcc to Vout clamp voltage 2	60	65	72		Id=6A see fig. 2
Vih(1)	High level Input threshold voltage	—	3	5		Id=10mA
Vil(1)	Low level Input threshold voltage	1.5	2.3	—		
Vf	Forward body diode voltage $T_j = 25^{\circ}\text{C}$	—	0.8	0.9		If=1A
	Forward body diode voltage $T_j = 125^{\circ}\text{C}$	—	0.65	0.75		

(1) Input thresholds are measured directly between the input pin and the tab.

## Switching Electrical Characteristics

$V_{cc} = 28\text{V}$ , Resistive load=27Ω,  $T_j = 25^{\circ}\text{C}$

Symbol	Parameter	Min.	Typ.	Max.	Units	Test Conditions
tdon	Turn on delay time to 20%	4	10	20	μs	See fig. 1
tr	Rise time from 20% to 80% of Vcc	2	5	10		
tdoff	Turn off delay time	20	40	80	μs	
tf	Fall time from 80% to 20% of Vcc	2.5	5	10		

## Protection Characteristics

$T_j = -40^{\circ}\text{C}..150^{\circ}\text{C}$ ,  $V_{cc} = 6-50\text{V}$  (unless otherwise specified)

Symbol	Parameter	Min.	Typ.	Max.	Units	Test Conditions
Tsd	Over temperature threshold	150(2)	165	—	°C	See fig. 3 and fig.11
I <sub>sd</sub>	Over-current shutdown	4	7	10	A	See fig. 3 and page 7
I fault	I <sub>fb</sub> after an over-current or an over-temperature (latched)	2.2	3	5	mA	See fig. 3

## Current Sensing Characteristics

$T_j = -40^{\circ}\text{C}..150^{\circ}\text{C}$ ,  $V_{cc} = 6-50\text{V}$  (unless otherwise specified). Specified 500μs after the turn on.  $V_{cc} - V_{ifb} > 4\text{V}$ . Typical value are given for 28V and 25°C.

Symbol	Parameter	Min.	Typ.	Max.	Units	Test Conditions
Ratio	I load / I <sub>fb</sub> current ratio	2000	2400	2800		I <sub>out</sub> <4A
Ratio_TC	I load / I <sub>fb</sub> variation over temperature(2)	-5%	0	+5	%	$T_j = -40^{\circ}\text{C}$ to $+150^{\circ}\text{C}$
I offset	Load current offset	-0.02	0	0.02	A	I <sub>out</sub> <4A
I <sub>fb</sub> leakage	I <sub>fb</sub> leakage current On in open load	0	1	10	μA	I <sub>out</sub> =0A, $V_{cc} - V_{in} = 28\text{V}$

(2) Guaranteed by design



## Truth Table

Op. Conditions	Input	Output	I <sub>fb</sub> pin voltage
Normal mode	H	L	0V
Normal mode	L	H	I <sub>load</sub> x R <sub>fb</sub> / Ratio
Open load	H	L	0V
Open load	L	H	0V
Short circuit to GND	H	L	0V
Short circuit to GND	L	L	V fault (latched)
Over temperature	H	L	0V
Over temperature	L	L	V fault (latched)

## Operating voltage

**Maximum V<sub>cc</sub> voltage** : this is the maximum voltage before the breakdown of the IC process.

**Operating voltage** : This is the V<sub>cc</sub> range in which the functionality of the part is guaranteed. The AEC-Q100 qualification is run at the maximum operating voltage specified in the datasheet.

## Reverse battery

During the reverse battery the Mosfet is kept off and the load current is flowing into the body diode of the power Mosfet.

Power dissipation in the IPS : P = I<sub>load</sub> \* V<sub>f</sub>

There is no protection, so T<sub>j</sub> must be lower than 150°C in the worst case condition of current and ambient temperature.

If the power dissipation is too high in R<sub>fb</sub>, a diode in serial can be added to block the current.

The transistor used to pull-down the input should be a bipolar in order to block the reverse current. The 100ohm input resistor can not sustain continuously 16V (see V<sub>cc</sub>-V<sub>in</sub> max. in the Absolute Maximum Ratings section)

## Active clamp

The purpose of the active clamp is to limit the voltage across the MOSFET to a value below the body diode break down voltage to reduce the amount of stress on the device during switching.

The temperature increase during active clamp can be estimated as follows:

$$\Delta T_j = P_{CL} \cdot Z_{TH}(t_{CLAMP})$$

Where: Z<sub>TH</sub>(t<sub>CLAMP</sub>) is the thermal impedance at t<sub>CLAMP</sub> and can be read from the thermal impedance curves given in the data sheets.

P<sub>CL</sub> = V<sub>CL</sub> · I<sub>CLavg</sub> : Power dissipation during active clamp

V<sub>CL</sub> = 65V : Typical V<sub>CLAMP</sub> value.

I<sub>CLavg</sub> =  $\frac{I_{CL}}{2}$  : Average current during active clamp

t<sub>CL</sub> =  $\frac{I_{CL}}{\left| \frac{di}{dt} \right|}$  : Active clamp duration

$\frac{di}{dt} = \frac{V_{Battery} - V_{CL}}{L}$  : Demagnetization current

Figure 9 gives the maximum inductance versus the load current in the worst case : the part switches off after an over temperature detection. If the load inductance exceeds the curve, a free wheeling diode is required.

## Over-current protection

The threshold of the over-current protection is set in order to guarantee that the device is able to turn on a load with an inrush current lower than the minimum of  $I_{sd}$ . Nevertheless for high current and high temperature the device may switch off for a lower current due to the over-temperature protection. This behavior is shown in Figure 11.

## Current sensing accuracy

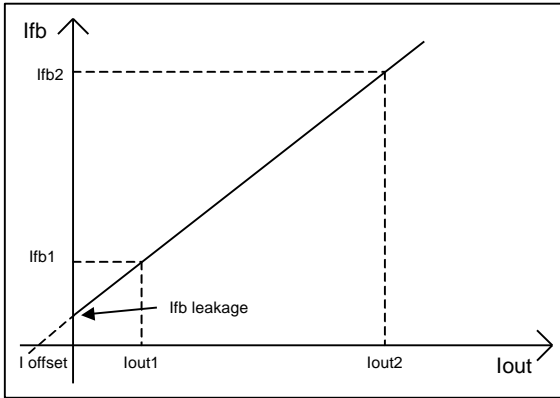

The current sensing is specified by measuring 3 points :

- Ifb1 for Iout1
- Ifb2 for Iout2
- Ifb leakage for Iout=0

The parameters in the datasheet are computed with the following formula :

$$\text{Ratio} = (I_{out2} - I_{out1}) / (I_{fb2} - I_{fb1})$$

$$I_{offset} = I_{fb1} \times \text{Ratio} - I_{out1}$$

This allows the designer to evaluate the Ifb for any Iout value using :

$$I_{fb} = (I_{out} + I_{offset}) / \text{Ratio} \text{ if } I_{fb} > I_{fb \text{ leakage}}$$

For some applications, a calibration is required. In that case, the accuracy of the system will depend on the variation of the  $I_{offset}$  and the ratio over the temperature range. The ratio variation is given by  $\text{Ratio}_{TC}$  specified in page 4.

The  $I_{offset}$  variation depends directly on the  $R_{dson}$  :

$$I_{offset@-40^{\circ}\text{C}} = I_{offset@25^{\circ}\text{C}} / 0.8$$

$$I_{offset@150^{\circ}\text{C}} = I_{offset@25^{\circ}\text{C}} / 1.9$$

### Maximum Vcc voltage with short circuit protection

The maximum Vcc voltage with short circuit is the maximum voltage for which the part is able to protect itself under test conditions representative of the application. 2 kind of short circuits are considered : terminal and load short circuit.

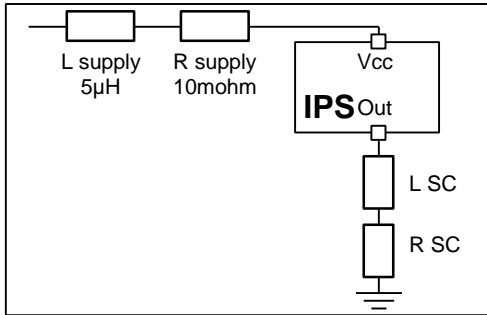

	L SC	R SC
Terminal SC	0.1 µH	10 mohm
Load SC	10 µH	100 mohm

### Maximum current during reverse circulation

In case of short circuit to battery, a voltage drop of the Vcc may create a current which circulate in reverse mode. When the device is on, this reverse circulation current will not trigger the internal fault latch. This immunization is also true when the part turns on while a reverse current flows into the device. The maximum current ( $I_{rev}$ ) is specified in the maximum rating section.

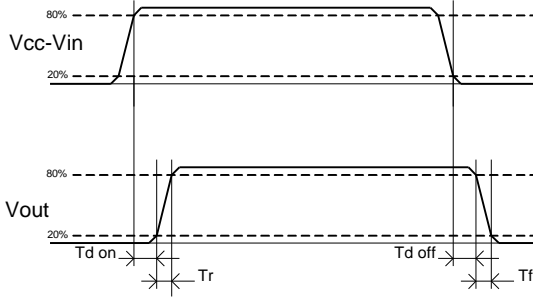

**Figure 1 – IN rise time & switching definitions**

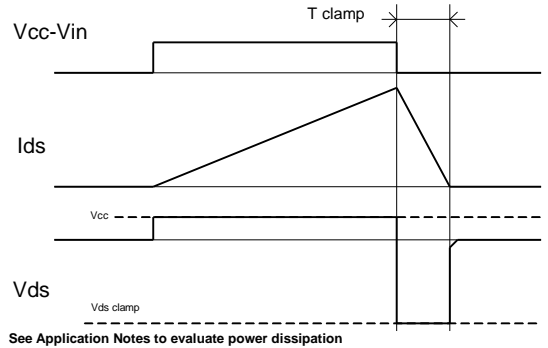

**Figure 2 – Active clamp waveforms**

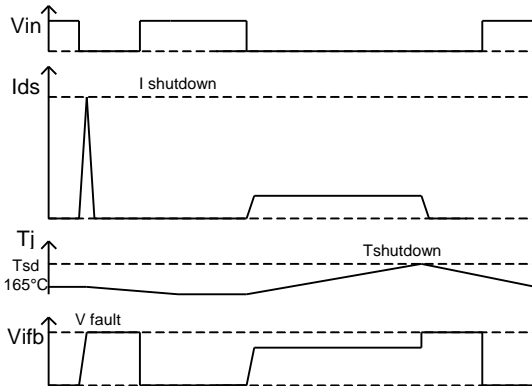

**Figure 3 – Protection timing diagram**

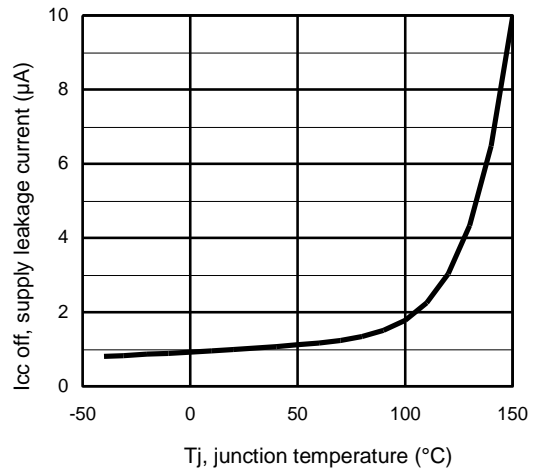

**Figure 4 – Icc off (µA) Vs Tj (°C)**

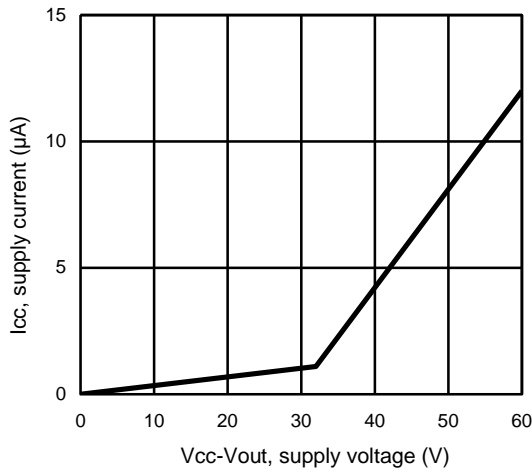

**Figure 5 – Icc off (µA) Vs Vcc-Vout (V)**

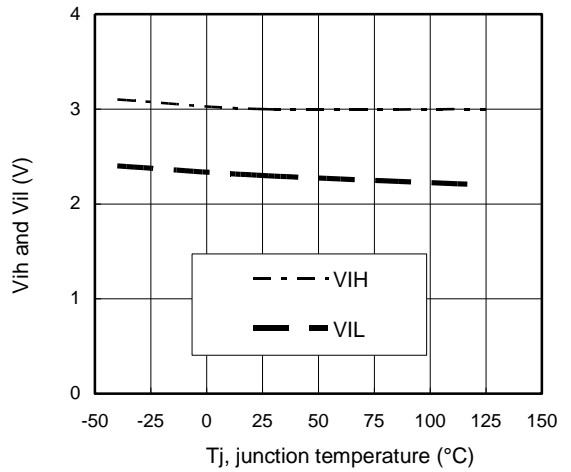

**Figure 6 – Vih and Vil (V) Vs Tj (°C)**

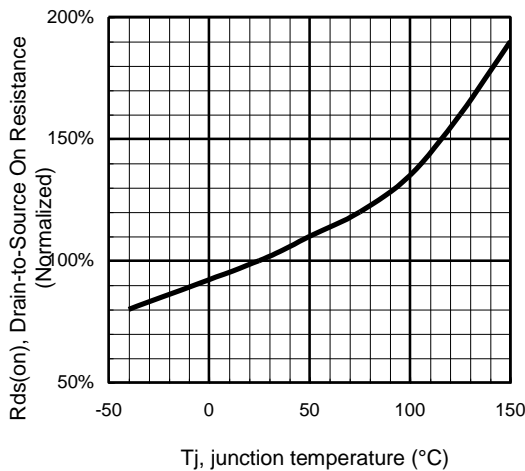

**Figure 7 - Normalized Rds(on) (%) Vs Tj (°C)**

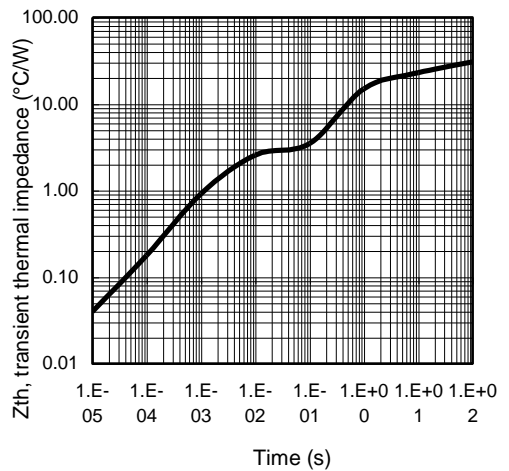

**Figure 8 – Transient thermal impedance (°C/W) Vs time (s)**

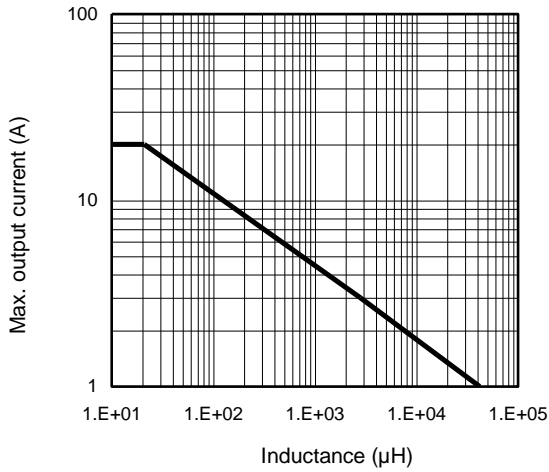

**Figure 9 – Max. I<sub>out</sub> (A) Vs inductance (µH)**

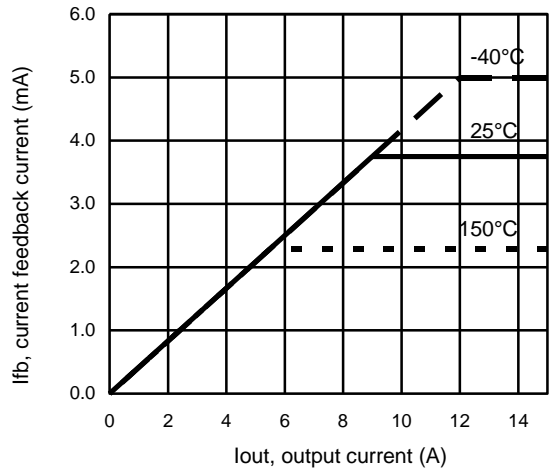

**Figure 10 – I<sub>fb</sub> (mA) Vs I<sub>out</sub> (A)**

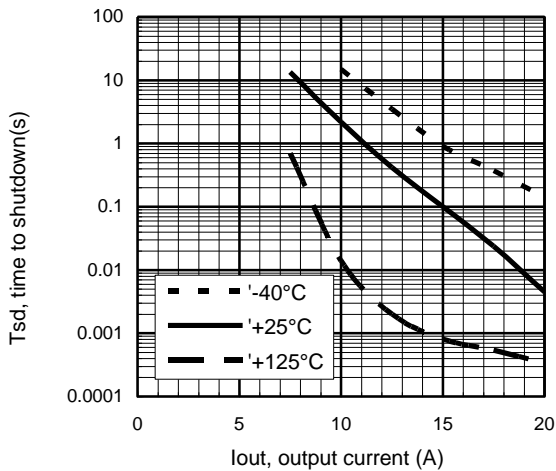

**Figure 11 – T<sub>sd</sub> (s) Vs I<sub>out</sub> (A)  
 SMD with 6cm<sup>2</sup>**

## Case Outline - SO-8

Dimensions are shown in millimeters (inches)

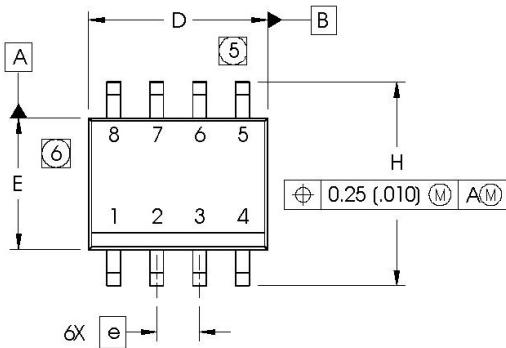

DIM	INCHES		MILLIMETERS	
	MIN	MAX	MIN	MAX
A	.0532	.0688	1.35	1.75
A1	.0040	.0098	0.10	0.25
b	.013	.020	0.33	0.51
c	.0075	.0098	0.19	0.25
D	.189	.1968	4.80	5.00
E	.1497	.1574	3.80	4.00
e	.050 BASIC		1.27 BASIC	
e1	.025 BASIC		0.635 BASIC	
H	.2284	.2440	5.80	6.20
K	.0099	.0196	0.25	0.50
L	.016	.050	0.40	1.27
y	0°	8°	0°	8°

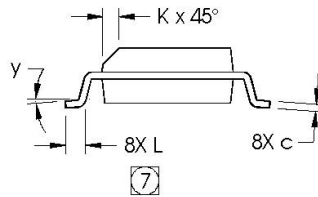
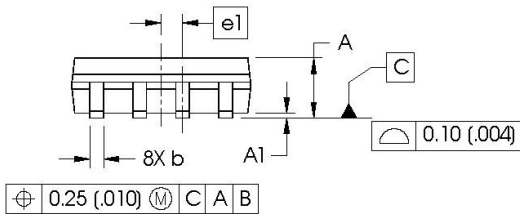

### NOTES:

- DIMENSIONING & TOLERANCING PER ASME Y14.5M-1994.
- CONTROLLING DIMENSION: MILLIMETER
- DIMENSIONS ARE SHOWN IN MILLIMETERS (INCHES).
- OUTLINE CONFORMS TO JEDEC OUTLINE MS-012AA.
- DIMENSION DOES NOT INCLUDE MOLD PROTRUSIONS. MOLD PROTRUSIONS NOT TO EXCEED 0.15 (.006).
- DIMENSION DOES NOT INCLUDE MOLD PROTRUSIONS. MOLD PROTRUSIONS NOT TO EXCEED 0.25 (.010).
- DIMENSION IS THE LENGTH OF LEAD FOR SOLDERING TO A SUBSTRATE.

### FOOTPRINT

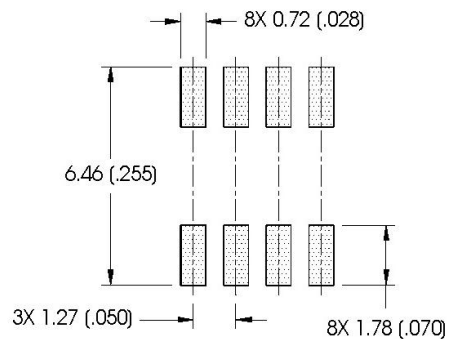

**Tape & Reel - SO-8**

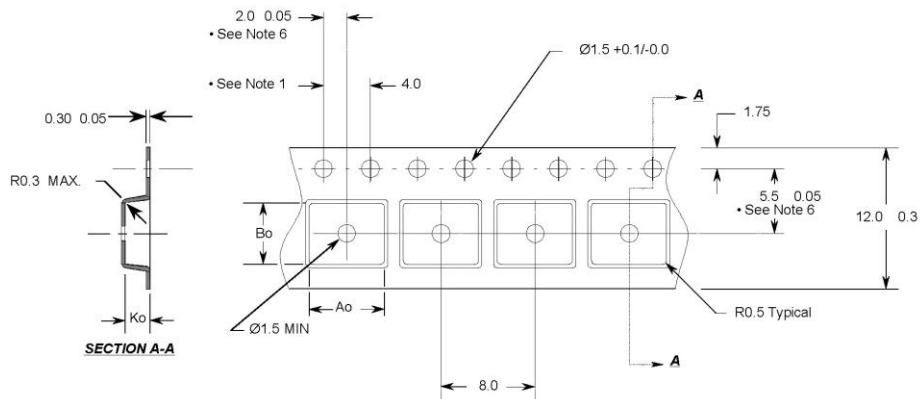

**Notes:**

1. 10 sprocket hole pitch cumulative tolerance 0.2
2. Camber not to exceed 1mm in 100mm
3. Material: Black Conductive Advantek Polystyrene
4. Ao and Bo measured on a plane 0.3mm above the bottom of the pocket
5. Ko measured from a plane on the inside bottom of the pocket to the top surface of the carrier.
6. Pocket position relative to sprocket hole measured as true position of pocket, not pocket hole.

Ao = 6.4 mm  
 Bo = 5.2 mm  
 Ko = 2.1 mm

- All Dimensions in Millimeters -

## Part Marking Information

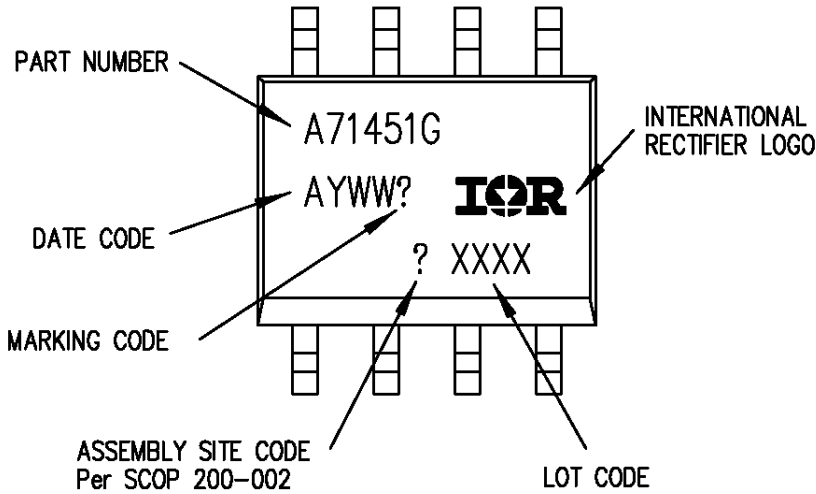

## Ordering Information

Base Part Number	Package Type	Standard Pack		Complete Part Number
		Form	Quantity	
AUIPS71451G	SO8	Tube	95	AUIPS71451G
		Tape and reel	2500	AUIPS71451GTR

## IMPORTANT NOTICE

Unless specifically designated for the automotive market, International Rectifier Corporation and its subsidiaries (IR) reserve the right to make corrections, modifications, enhancements, improvements, and other changes to its products and services at any time and to discontinue any product or services without notice. Part numbers designated with the "AU" prefix follow automotive industry and / or customer specific requirements with regards to product discontinuance and process change notification. All products are sold subject to IR's terms and conditions of sale supplied at the time of order acknowledgment.

IR warrants performance of its hardware products to the specifications applicable at the time of sale in accordance with IR's standard warranty. Testing and other quality control techniques are used to the extent IR deems necessary to support this warranty. Except where mandated by government requirements, testing of all parameters of each product is not necessarily performed.

IR assumes no liability for applications assistance or customer product design. Customers are responsible for their products and applications using IR components. To minimize the risks with customer products and applications, customers should provide adequate design and operating safeguards.

Reproduction of IR information in IR data books or data sheets is permissible only if reproduction is without alteration and is accompanied by all associated warranties, conditions, limitations, and notices. Reproduction of this information with alterations is an unfair and deceptive business practice. IR is not responsible or liable for such altered documentation. Information of third parties may be subject to additional restrictions.

Resale of IR products or serviced with statements different from or beyond the parameters stated by IR for that product or service voids all express and any implied warranties for the associated IR product or service and is an unfair and deceptive business practice. IR is not responsible or liable for any such statements.

IR products are not designed, intended, or authorized for use as components in systems intended for surgical implant into the body, or in other applications intended to support or sustain life, or in any other application in which the failure of the IR product could create a situation where personal injury or death may occur. Should Buyer purchase or use IR products for any such unintended or unauthorized application, Buyer shall indemnify and hold International Rectifier and its officers, employees, subsidiaries, affiliates, and distributors harmless against all claims, costs, damages, and expenses, and reasonable attorney fees arising out of, directly or indirectly, any claim of personal injury or death associated with such unintended or unauthorized use, even if such claim alleges that IR was negligent regarding the design or manufacture of the product.

Only products certified as military grade by the Defense Logistics Agency (DLA) of the US Department of Defense, are designed and manufactured to meet DLA military specifications required by certain military, aerospace or other applications. Buyers acknowledge and agree that any use of IR products not certified by DLA as military-grade, in applications requiring military grade products, is solely at the Buyer's own risk and that they are solely responsible for compliance with all legal and regulatory requirements in connection with such use.

IR products are neither designed nor intended for use in automotive applications or environments unless the specific IR products are designated by IR as compliant with ISO/TS 16949 requirements and bear a part number including the designation "AU". Buyers acknowledge and agree that, if they use any non-designated products in automotive applications, IR will not be responsible for any failure to meet such requirements.

For technical support, please contact IR's Technical Assistance Center  
<http://www.irf.com/technical-info/>

**WORLD HEADQUARTERS:**







101 N. Sepulveda Blvd., El Segundo, California 90245  
Tel: (310) 252-7105

## Looking for pricing, stock, or lifecycle information?

Click below to explore more details on WIN SOURCE:

-  [View AUIPS71451G on WIN SOURCE](#)
-  [Infineon Technologies](#) Information

## Optimize Your Supply Chain with WIN SOURCE Solutions

-  Global Sourcing Solution
-  Obsolete Management
-  Cost Control Management
-  Shortage Management
-  Alternative Solution
-  Excess Inventory Management