



**THE DATASHEET OF
AQV453AX**



Panasonic
ideas for life

ALUS (Standard type) **ALUS** **ESI** (Standard type)

**Normally closed
DIP6-pin type
Low on-resistance with
250V/400V load voltage**

**PhotoMOS Relays
HE 1 Form B
(AQV450, AQV454H)**

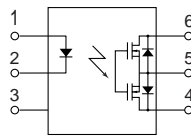
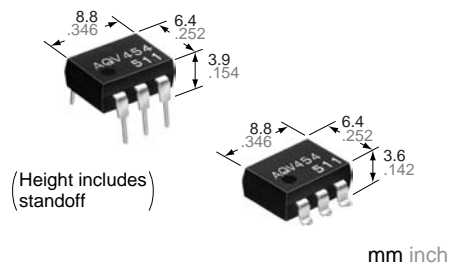

Compliance with RoHS Directive

FEATURES

1. 1 Form B (Normally-closed) type with low on-resistance

This has been achieved thanks to the built-in MOSFET processed by our proprietary method, DSD (Double-diffused and Selective Doping) method.

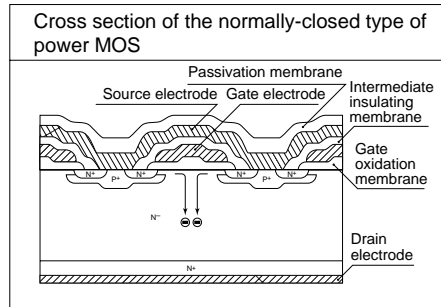

2. Controls low-level analog signals

PhotoMOS relays feature extremely low closed-circuit offset voltage to enable control of low-level analog signals without distortion.

3. High sensitivity and low on-resistance

Can control max. 0.2 A load current with 5 mA input current. Low on-resistance of typ. 5.5 Ω (AQV453).

4. Reinforced insulation 5,000 V type also available.

More than 0.4 mm .016 inch internal insulation distance between inputs and outputs. Conforms to IEC950 (reinforced insulation).

TYPICAL APPLICATIONS

- Security equipment
- High-speed inspection machines
- Measuring instruments
- Telephone equipment
- Sensing equipment

TYPES

	I/O isolation	Output rating*		Package	Part No.				Packing quantity	
		Load voltage	Load current		Through hole terminal	Surface-mount terminal		Tube	Tape and reel	
						Tape and reel packing style				
				Tube packing style		Picked from the 1/2/3-pin side	Picked from the 4/5/6-pin side			
AC/DC dual use	1,500 V AC	250 V	200 mA	DIP6-pin	AQV453	AQV453A	AQV453AX	AQV453AZ	1 tube contains: 50 pcs. 1 batch contains: 500 pcs.	1,000 pcs.
		400 V	150 mA		AQV454	AQV454A	AQV454AX	AQV454AZ		
	Reinforced 5,000 V AC				AQV454H	AQV454HA	AQV454HAX	AQV454HAZ		

* Indicate the peak AC and DC values.
Note: The surface mount terminal indicator "A" and the packing style indicator "X" or "Z" are not marked on the relay.

RATING

1. Absolute maximum ratings (Ambient temperature: 25°C 77°F)

Item	Symbol	Type of connection	AQV453(A)	AQV454(A)	AQV454H(A)	Remarks
Input	LED forward current	I _F	50 mA			
	LED reverse voltage	V _R	5 V			
	Peak forward current	I _{FP}	1 A			f = 100 Hz, Duty factor = 0.1%
	Power dissipation	P _{in}	75 mW			
Output	Load voltage (peak AC)	V _L	250 V	400 V		
	Continuous load current	I _L	A	0.2 A	0.15 A	A connection: Peak AC, DC B, C connection: DC
			B	0.3 A	0.18 A	
			C	0.4 A	0.25 A	
	Peak load current	I _{PEAK}	0.6 A	0.5 A		A connection: 100 ms (1 shot), V _L = DC
	Power dissipation	P _{OUT}	360 mW			
Total power dissipation	P _T	410 mW				
I/O isolation voltage	V _{iso}		1,500 V AC	5,000 V AC		
Temperature limits	Operating	T _{opr}	-40°C to +85°C -40°F to +185°F			Non-condensing at low temperatures
	Storage	T _{stg}	-40°C to +100°C -40°F to +212°F			

HE 1 Form B (AQV45○, AQV454H)

2. Electrical characteristics (Ambient temperature: 25°C 77°F)

Item		Symbol	Type of connection	AQV453(A)	AQV454(A)	AQV454H(A)	Remarks
Input	LED operate (OFF) current	Typical	—	1 mA	0.9 mA	1.4 mA	I _L = Max.
		Maximum					
	LED reverse (ON) current	Minimum	—	0.4 mA			I _L = Max.
		Typical		0.9 mA	0.8 mA	1.3 mA	
LED dropout voltage	Typical	V _F	—	1.25 V (1.14 V at I _F =5 mA)			I _F = 50 mA
	Maximum			1.5 V			
Output	On resistance	Typical	A	5.5 Ω	11 Ω		I _F = 0 mA I _L = Max. Within 1 s on time
		Maximum		8 Ω	16 Ω		
	On resistance	Typical	B	2.7 Ω	6.3 Ω		I _F = 0 mA I _L = Max. Within 1 s on time
		Maximum		4 Ω	8 Ω		
	On resistance	Typical	C	1.4 Ω	3.1 Ω		I _F = 0 mA I _L = Max. Within 1 s on time
		Maximum		2 Ω	4 Ω		
Off state leakage current	Maximum	I _{Leak}	—	1 μA	1 μA	10 μA	I _F = 5 mA V _L = Max.
Transfer characteristics	Operate (OFF) time*	Typical	—	1.52 ms	1.2 ms	1.8 ms	I _F = 0 mA → 5 mA I _L = Max.
		Maximum		3 ms	2.0 ms	3.0 ms	
	Reverse (ON) time*	Typical	—	0.4 ms	0.36 ms	0.4 ms	I _F = 5 mA → 0 mA I _L = Max.
		Maximum		1 ms			
I/O capacitance	Typical	C _{iso}	—	1.3 pF			f = 1 MHz V _B = 0 V
	Maximum			3 pF			
Initial I/O isolation resistance	Minimum	R _{iso}	—	1,000 MΩ			500 V DC

*Operate/Reverse time

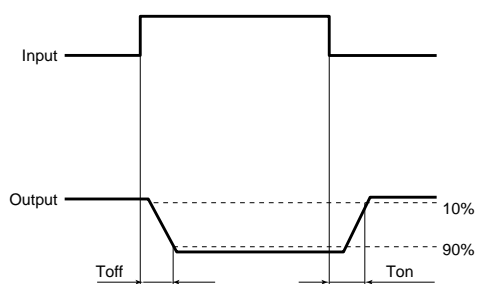

RECOMMENDED OPERATING CONDITIONS

Please obey the following conditions to ensure proper relay operation and resetting.

Item	Symbol	Recommended value	Unit
Input LED current	I _F	Standard type: 5 Reinforced insulation type: 5 to 10	mA

■ For Dimensions

■ For Schematic and Wiring Diagrams

■ For Cautions for Use

■ These products are not designed for automotive use.

If you are considering to use these products for automotive applications, please contact your local Panasonic Electric Works technical representative.

For more information

HE 1 Form B (AQV450, AQV454H)

REFERENCE DATA

1. Load current vs. ambient temperature characteristics

Allowable ambient temperature: -40°C to $+85^{\circ}\text{C}$
 -40°F to $+185^{\circ}\text{F}$

Type of connection: A

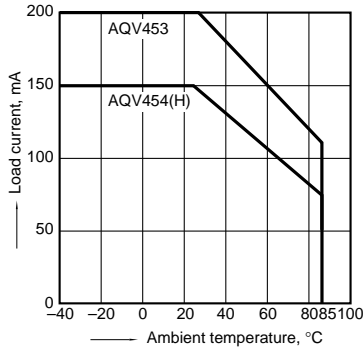

2. On resistance vs. ambient temperature characteristics

Measured portion: between terminals 4 and 6;
 LED current: 0 mA; Load voltage: Max. (DC);
 Continuous load current: Max. (DC)

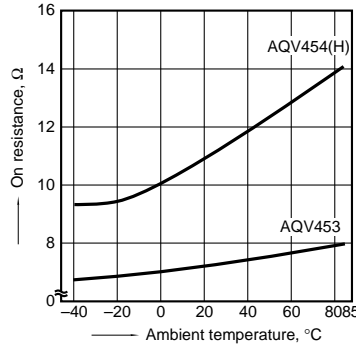

3. Operate (OFF) time vs. ambient temperature characteristics

LED current: 5 mA; Load voltage: Max. (DC);
 Continuous load current: Max. (DC)

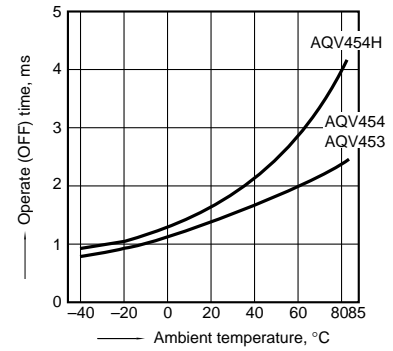

4. Reverse (ON) time vs. ambient temperature characteristics

LED current: 5 mA; Load voltage: Max. (DC);
 Continuous load current: Max. (DC)

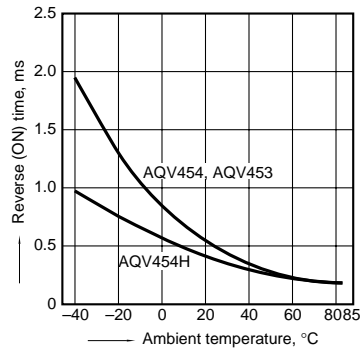

5. LED operate (OFF) current vs. ambient temperature characteristics

Load voltage: Max. (DC);
 Continuous load current: Max. (DC)

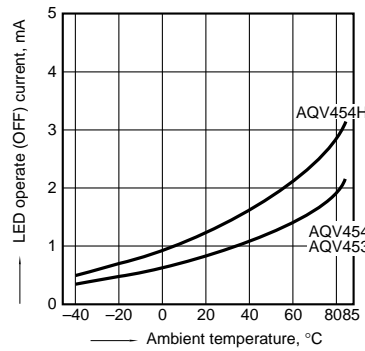

6. LED reverse (ON) current vs. ambient temperature characteristics

Load voltage: Max. (DC);
 Continuous load current: Max. (DC)

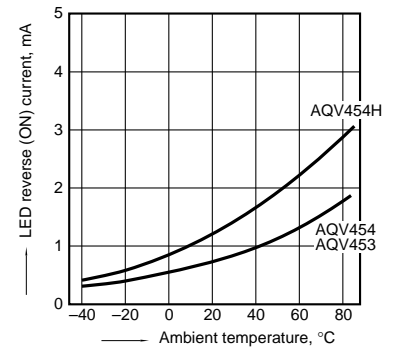

7. LED dropout voltage vs. ambient temperature characteristics

LED current: 5 to 50 mA

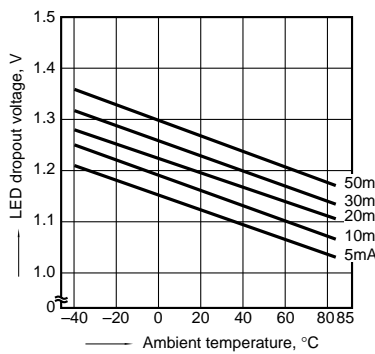

8. Current vs. voltage characteristics of output at MOS portion

Measured portion: between terminals 4 and 6;
 Ambient temperature: 25°C 77°F

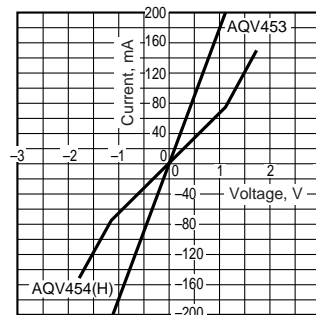

9. Off state leakage current vs. load voltage characteristics

Sample: AQV454;
 Measured portion: between terminals 4 and 6;
 Ambient temperature: 25°C 77°F

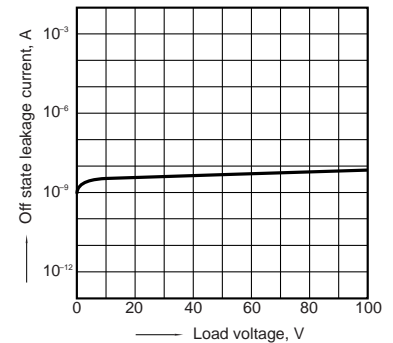

10. Operate (OFF) time vs. LED forward current characteristics

Measured portion: between terminals 4 and 6;
 Load voltage: Max. (DC); Continuous load current: Max. (DC); Ambient temperature: 25°C 77°F

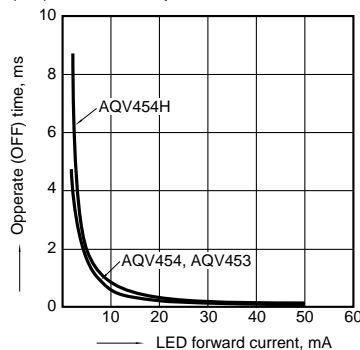

11. Reverse (ON) time vs. LED forward current characteristics

Measured portion: between terminals 4 and 6;
 Load voltage: Max. (DC); Continuous load current: Max. (DC); Ambient temperature: 25°C 77°F

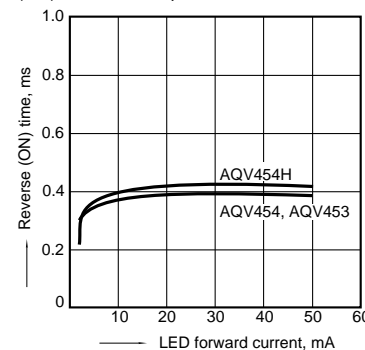

12. Output capacitance vs. applied voltage characteristics

Measured portion: between terminals 4 and 6;
 Frequency: 1 MHz; Ambient temperature: 25°C 77°F

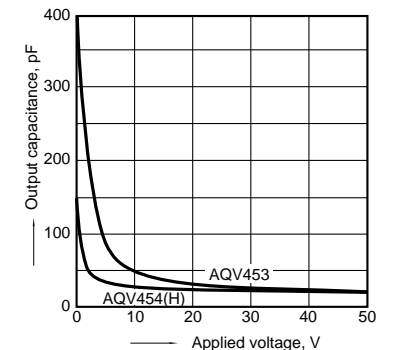





Looking for pricing, stock, or lifecycle information?

Click below to explore more details on WIN SOURCE:

 [View AQV453AX on WIN SOURCE](#)

 [Panasonic Information](#)

Optimize Your Supply Chain with WIN SOURCE Solutions

-  Global Sourcing Solution
-  Obsolete Management
-  Cost Control Management
-  Shortage Management
-  Alternative Solution
-  Excess Inventory Management