



# SAC Series

## Axial Leaded – 500W



### Additional Information



Resources



Accessories



Samples

### Agency Approvals

Agency	Agency File Number
	E230531

### Maximum Ratings and Thermal Characteristics

( $T_A=25^{\circ}\text{C}$  unless otherwise noted)

Parameter	Symbol	Value	Unit
Peak Pulse Power Dissipation by 10/1000 $\mu\text{s}$ Test Waveform (Fig.1) (Note 1)	$P_{\text{PPM}}$	500	W
Steady State Power Dissipation on Infinite Heat Sink at $T_L=75^{\circ}\text{C}$	$P_D$	3.0	W
Operating Junction and Storage Temperature Range	$T_J, T_{\text{STG}}$	-65 to 175	$^{\circ}\text{C}$
Typical Thermal Resistance Junction to Lead	$R_{\theta\text{JL}}$	20	$^{\circ}\text{C}/\text{W}$
Typical Thermal Resistance Junction to Ambient	$R_{\theta\text{JA}}$	75	$^{\circ}\text{C}/\text{W}$

#### Note:

1. Non-repetitive current pulse, per Fig. 3 and derated above  $T_J$  (initial) =  $25^{\circ}\text{C}$  per Fig. 2.

### Description

The SAC Series is designed specifically to protect sensitive electronic equipment from voltage transients induced by lightning and other transient voltage events.

### Features & Benefits

- 500W peak pulse power capability at 10/1000 $\mu\text{s}$  waveform, repetition rate (duty cycles):0.01%
- Glass passivated chip junction in DO-15 Package
- Fast response time: typically less than 1.0ps from 0 Volts to BV min
- Typical failure mode is short from over-specified voltage or current
- Whisker test is conducted based on JEDECJESD201A per its table 4a and 4c
- IEC-61000-4-2 ESD 30kV(Air), 30kV (Contact)
- ESD protection of data lines in accordance with IEC 61000-4-2
- Low incremental surge resistance
- EFT protection of data lines in accordance with IEC 61000-4-4
- High temperature to reflow soldering guaranteed: 260 $^{\circ}\text{C}/30\text{sec}$  / 0.375"(9.5mm) lead length, 5 lbs., (2.3kg) tension
- Plastic package is flammability rated V-0 per Underwriters Laboratories
- Matte tin lead-free plated
- Ideal for data line applications
- Halogen free and RoHS compliant
- Pb-free E3 means 2nd level interconnect is Pb-free and the terminal finish material is tin(Sn) (IPC/JEDEC J-STD-609A.01)

### Applications

TVS devices are ideal for the protection of I/O interfaces, VCC bus and other vulnerable circuits used in telecom, computer, industrial and consumer electronic applications.

### Schematic

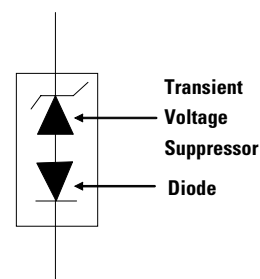

# SAC Series

## Axial Leaded – 500W

### Electrical Characteristics ( $T_A=25^\circ\text{C}$ unless otherwise noted)

Part Number	Reverse Stand off Voltage $V_R$ (V)	Breakdown Voltage $V_{BR}$ (V)		Maximum Reverse Leakage $I_R @ V_R$ ( $\mu\text{A}$ )	Maximum Clamping Voltage $V_C @ I_{PP}$ (V)	Maximum Peak Pulse Current (Fig.3) $I_{PP}$ (A)	Maximum Junction Capacitance @ 0Volts (pF)	Working Inverse Blocking Voltage $V_{WIB}$ (V)	Inverse Blocking Leakage Current at $I_B @ V_{WIB}$ (mA)	Peak Inverse Blocking Voltage $V_{PIB}$ (V)	Agency Approval 
		MIN	MAX								
SAC5.0	5.0	7.6	8.3	300	13.2	46.2	50	700	1	800	X
SAC6.0	6.0	7.9	9.3	300	12.2	43.1	50	700	1	800	X
SAC7.0	7.0	8.3	10.5	300	13.7	39.9	50	700	1	800	X
SAC8.0	8.0	8.9	10.9	100	13.9	37.8	50	700	1	800	X
SAC8.5	8.5	9.4	11.5	50	14.7	35.7	50	700	1	800	X
SAC10	10	11.1	13.6	5	17.2	30.5	50	700	1	800	X
SAC12	12	13.3	16.3	1	20.0	26.3	50	700	1	800	X
SAC15	15	16.7	20.4	1	25.0	21.0	50	700	1	800	X
SAC18	18	20.0	24.4	1	33.3	15.8	50	700	1	800	X
SAC22	22	24.4	29.8	1	35.7	14.7	50	700	1	800	X
SAC26	26	28.9	35.3	1	45.0	11.7	50	700	1	800	X
SAC30	30	33.3	41.1	1	50.0	10.5	50	700	1	800	X
SAC36	36	40.0	48.9	1	58.1	9.0	50	700	1	800	X
SAC45	45	50.0	61.1	1	73.5	7.1	50	700	1	800	X
SAC50	50	55.5	66.6	1	86.2	6.1	50	700	1	800	X
SAC55	55	60.5	66.9	1	87.0	5.7	50	700	1	800	X
SAC60	60	66.0	72.9	1	95.0	5.3	50	700	1	800	X
SAC65	65	71.5	79.0	1	103.0	4.9	50	700	1	800	X
SAC70	70	77.0	85.1	1	111.0	4.5	50	700	1	800	X
SAC75	75	82.5	91.2	1	119.0	4.2	50	700	1	800	X
SAC80	80	88.0	97.2	1	127.0	3.9	50	700	1	800	X
SAC85	85	93.5	103.3	1	135.0	3.7	45	700	1	800	X
SAC90	90	99.0	109.4	1	143.0	3.5	45	700	1	800	X
SAC95	95	104.5	115.5	1	151.0	3.3	45	700	1	800	X
SAC100	100	110.0	121.0	1	158.0	3.2	40	700	1	800	X
SAC110	110	120.0	133.0	1	173.0	2.9	40	700	1	800	X
SAC120	120	131.0	145.0	1	189.0	2.6	40	700	1	800	X
SAC130	130	142.0	160.0	1	209.0	2.4	35	700	1	800	X
SAC140	140	153.0	170.0	1	219.0	2.3	35	700	1	800	X
SAC150	150	164.0	182.0	1	237.0	2.1	35	700	1	800	X

# SAC Series

## Axial Leaded – 500W

### Ratings and Characteristic Curves ( $T_A=25^\circ\text{C}$ unless otherwise noted)

**Figure 1:**  
Peak Pulse Power Rating Curve

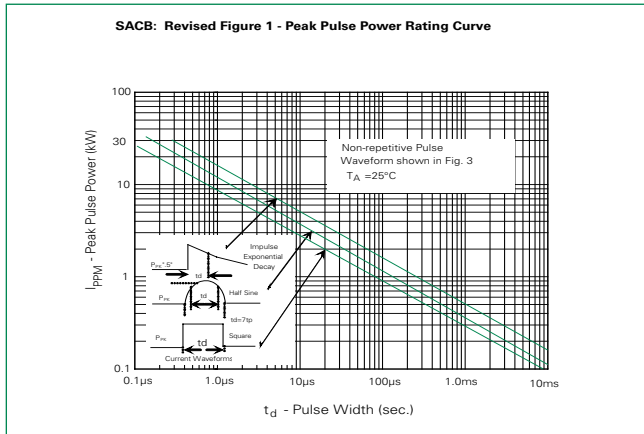

**Figure 2:**  
Peak Pulse Power Derating Curve

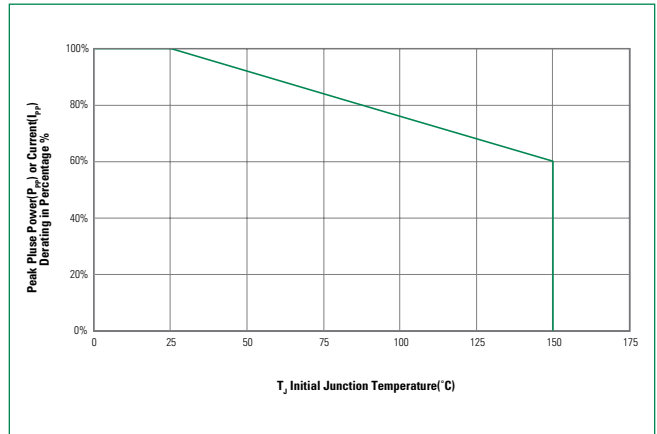

**Figure 3:**  
Pulse Waveform

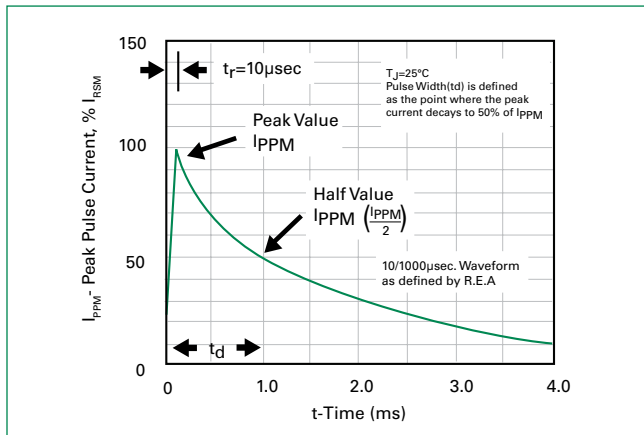

**Figure 4:**  
AC Line Protection Application

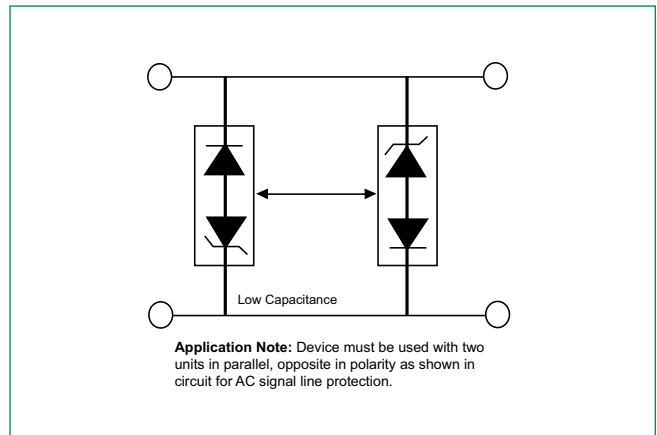

# SAC Series

## Axial Leaded – 500W

### Soldering Parameters

<b>Reflow Condition</b>		Lead-free assembly
<b>Pre Heat</b>	- Temperature Min ( $T_{s(min)}$ )	150°C
	- Temperature Max ( $T_{s(max)}$ )	200°C
	- Time (min to max) ( $t_s$ )	60 – 120 secs
<b>Average ramp up rate (Liquidus Temp (<math>T_A</math>) to peak)</b>		3°C/second max
<b><math>T_{s(max)}</math> to <math>T_A</math> - Ramp-up Rate</b>		3°C/second max
<b>Reflow</b>	- Temperature ( $T_A$ ) (Liquidus)	217°C
	- Time (min to max) ( $t_s$ )	60 – 150 seconds
<b>Peak Temperature (<math>T_p</math>)</b>		260 <sup>+0/-5</sup> °C
<b>Time within 5°C of actual peak Temperature (<math>t_p</math>)</b>		30 seconds max
<b>Ramp-down Rate</b>		6°C/second max
<b>Time 25°C to peak Temperature (<math>T_p</math>)</b>		8 minutes Max.
<b>Do not exceed</b>		260°C

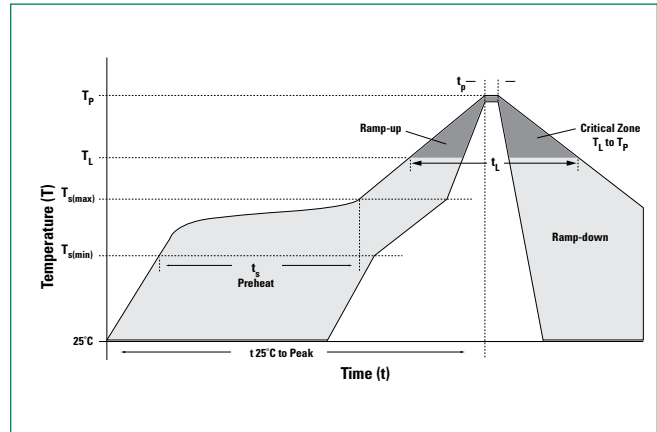

### Flow/Wave Soldering (Solder Dipping)

<b>Peak Temperature :</b>	265°C
<b>Dipping Time :</b>	10 seconds
<b>Soldering :</b>	1 time

### Physical Specifications

<b>Weight</b>	0.015oz., 0.4g
<b>Case</b>	JEDEC DO-204AC (DO-15) molded plastic body over passivated junction.
<b>Polarity</b>	Color band denotes the cathode except Bipolar.
<b>Terminal</b>	Matte Tin axial leads, solderable per JESD22-B102.

### Environmental Specifications

<b>High Temp. Storage</b>	JESD22-A103
<b>HTRB</b>	JESD22-A108
<b>Temperature Cycling</b>	JESD22-A104
<b>H3TRB</b>	JESD22-A101
<b>RSH</b>	JESD22-B106

### Dimensions

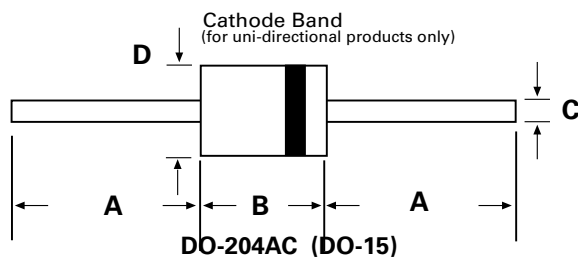

Dimensions	Inches		Millimeters	
	Min	Max	Min	Max
A	1.000	-	25.40	-
B	0.230	0.300	5.80	7.60
C	0.028	0.034	0.71	0.86
D	0.104	0.140	2.60	3.60

# SAC Series

## Axial Leaded – 500W

### Part Numbering System

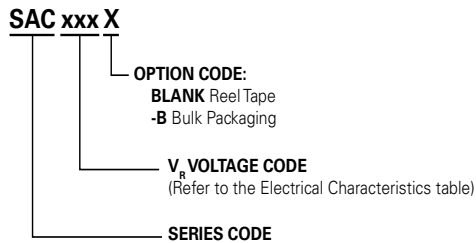

### Part Marking System

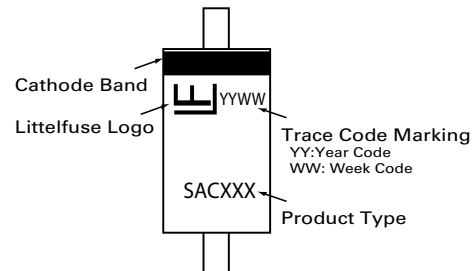

### Packaging

Part Number	Component Package	Quantity	Packaging Option	Packaging Specification
SACxxxXX	DO-204AC	4000	Tape & Reel	EIA STD RS-296
SACxxxXX-B	DO-204AC	1000	BULK	Littelfuse Spec.

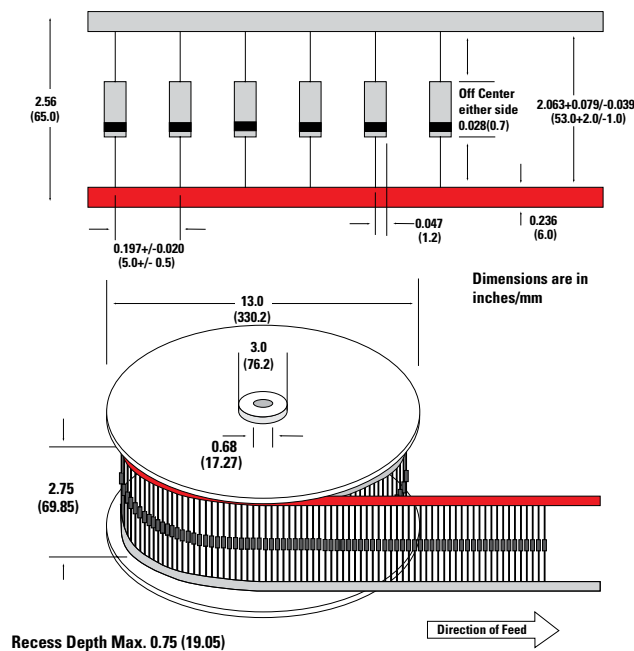

### Tape and Reel Specification



**Disclaimer Notice** - Information furnished is believed to be accurate and reliable. However, users should independently evaluate the suitability of and test each product selected for their own applications. Littelfuse products are not designed for, and may not be used in, all applications. Read complete Disclaimer Notice at [www.littelfuse.com/disclaimer-electronics](http://www.littelfuse.com/disclaimer-electronics).

## Looking for pricing, stock, or lifecycle information?

Click below to explore more details on WIN SOURCE:

-  [View SAC5.0 on WIN SOURCE](#)
-  [Littelfuse Inc. Information](#)

## Optimize Your Supply Chain with WIN SOURCE Solutions

-  Global Sourcing Solution
-  Obsolete Management
-  Cost Control Management
-  Shortage Management
-  Alternative Solution
-  Excess Inventory Management