



**THE DATASHEET OF
AP1086T50L-U**



Description

AP1086 is a low dropout positive adjustable or fixed-mode regulator with 1.5A output current capability. The product is specifically designed to provide well-regulated supply for low voltage IC applications such as high-speed bus termination and low current 3.3V logic supply. AP1086 is also well suited for other applications such as VGA cards. AP1086 is guaranteed to have lower than 1.4V dropout at full load current making it ideal to provide well-regulated outputs of 1.25V to 5.0V with 4.7 to 12V input supply by different output voltage.

Features

- 3-Terminal Adjustable or Fixed 1.5V, 1.8V, 2.5V, 3.3V, 5.0V
- 1.4V Maximum Dropout at Full Load Current
- Fast Transient Response
- Built-in Thermal Shutdown
- Output Current Limiting
- Lead Free Packages: TO252-3L, TO263-3L, TO220-3L
- TO252-3L, TO263-3L, and TO220-3L: Available in "Green" Molding Compound (No Br, Sb)
- Lead Free Finish/ RoHS Compliant (Note 1)

Notes: 1. EU Directive 2002/95/EC (RoHS). All applicable RoHS exemptions applied. Please visit our website at http://www.diodes.com/products/lead_free.html.

Pin Assignments

(Top View)

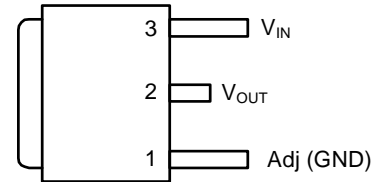

Tab is V_{OUT}
TO252-3L

(Top View)

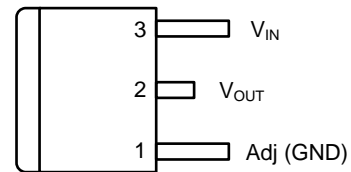

Tab is V_{OUT}
TO263-3L

(Top View)

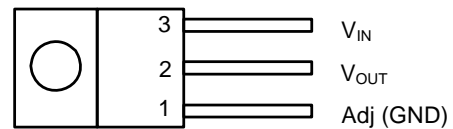

Tab is V_{OUT}
TO220-3L

Typical Application Circuit

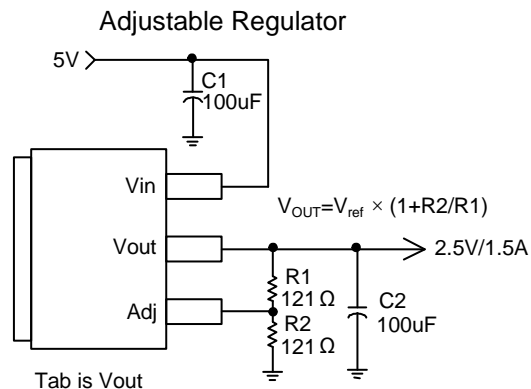
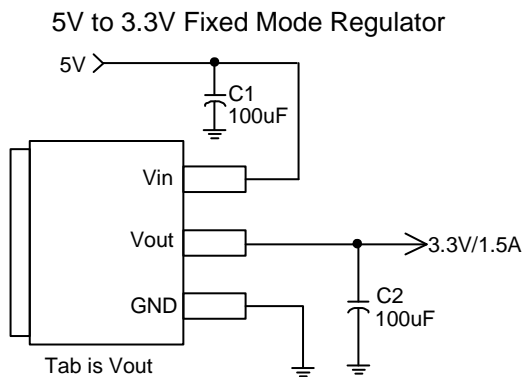

Note: $V_o = V_{RE} * \left(1 + \frac{R_2}{R_1} \right)$

**1.5A LOW DROPOUT POSITIVE ADJUSTABLE OR
FIXED-MODE REGULATOR**

Pin Descriptions

Pin Name	I/O	Pin #	Description
Adj (GND)		1	Adjustable (Ground only for fixed mode)
V _{OUT}	O	2	The output of the regulator. A minimum of 10uF capacitor must be connected from this pin to ground to insure stability.
V _{IN}	I	3	The input pin of regulator. Typically a large storage capacitor is connected from this pin to ground to insure that the input voltage does not sag below the minimum dropout voltage during the load transient response. This pin must always be 1.4V higher than V _{OUT} in order for the device to regulate properly.

Functional Block Diagram

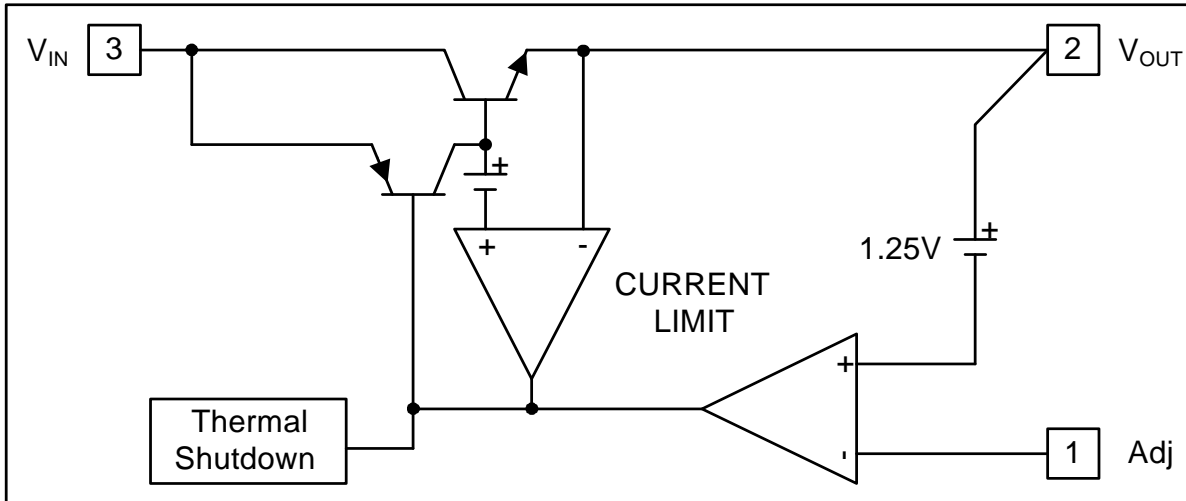

Absolute Maximum Ratings

Symbol	Parameter	Rating	Unit
V _{IN}	DC Supply Voltage	-0.3 to 12	V
T _{ST}	Storage Temperature	-65 to +150	°C
T _{MJ}	Maximum Junction Temperature	150	°C

Recommended Operating Conditions

Symbol	Parameter	Min	Max	Unit
Top	Operating Junction Temperature Range	0	125	°C

1.5A LOW DROPOUT POSITIVE ADJUSTABLE OR FIXED-MODE REGULATOR

Electrical Characteristics (Under Operating Conditions)

Parameter	Conditions		Min	Typ.	Max	Unit
Reference Voltage	AP1086-Adj	$T_A = 25^\circ\text{C}$, $(V_{IN}-V_{OUT}) = 1.5\text{V}$, $I_O = 10\text{mA}$	1.225	1.250	1.275	
Output Voltage	AP1086-1.5	$I_{OUT} = 10\text{mA}$, $T_A = 25^\circ\text{C}$, $3\text{V} \leq V_{IN} \leq 12\text{V}$	1.470	1.500	1.530	V
	AP1086-1.8	$I_{OUT} = 10\text{mA}$, $T_A = 25^\circ\text{C}$, $3.3\text{V} \leq V_{IN} \leq 12\text{V}$	1.764	1.800	1.836	V
	AP1086-2.5	$I_{OUT} = 10\text{mA}$, $T_A = 25^\circ\text{C}$, $4\text{V} \leq V_{IN} \leq 12\text{V}$	2.450	2.500	2.550	V
	AP1086-3.3	$I_{OUT} = 10\text{mA}$, $T_A = 25^\circ\text{C}$, $4.8\text{V} \leq V_{IN} \leq 12\text{V}$	3.235	3.300	3.365	V
	AP1086-5.0	$I_{OUT} = 10\text{mA}$, $T_A = 25^\circ\text{C}$, $6.5\text{V} \leq V_{IN} \leq 12\text{V}$	4.900	5.000	5.100	V
Line Regulation	AP1086-XXX	$I_O = 10\text{mA}$, $V_{OUT} + 1.5\text{V} < V_{IN} < 12\text{V}$	-	-	0.2	%
Load Regulation	AP1086-Adj	$V_{IN} = 3.3\text{V}$, $0\text{mA} < I_O < 1.5\text{A}$, $T_A = 25^\circ\text{C}$ (Note 2, 3)	-	-	1	%
	AP1086-1.5	$V_{IN} = 3\text{V}$, $0\text{mA} < I_O < 1.5\text{A}$, $T_A = 25^\circ\text{C}$ (Note 2, 3)	-	12	15	mV
	AP1086-1.8	$V_{IN} = 3.3\text{V}$, $0\text{mA} < I_O < 1.5\text{A}$, $T_A = 25^\circ\text{C}$ (Note 2, 3)	-	15	18	mV
	AP1086-2.5	$V_{IN} = 4\text{V}$, $0\text{mA} < I_O < 1.5\text{A}$, $T_A = 25^\circ\text{C}$ (Note 2, 3)	-	20	25	mV
	AP1086-3.3	$V_{IN} = 5\text{V}$, $0 \leq I_{OUT} \leq 1.5\text{A}$, $T_A = 25^\circ\text{C}$, $T_J = 25^\circ\text{C}$ (Note 2, 3)	-	26	33	mV
	AP1086-5.0	$V_{IN} = 8\text{V}$, $0 \leq I_{OUT} \leq 1.5\text{A}$, $T_A = 25^\circ\text{C}$, $T_J = 25^\circ\text{C}$ (Note 2, 3)	-	40	50	mV
Dropout Voltage ($V_{IN}-V_{OUT}$)	AP1086-Adj/-2.5/ -3.3/-3.6/-5.0	$I_{OUT} = 1.5\text{A}$, $\Delta V_{OUT} = 1\%V_{OUT}$	-	1.3	1.4	V
Current Limit	AP1086-Adj/-2.5/ -3.3/-3.6/-5.0	$(V_{IN}-V_{OUT}) = 5\text{V}$	1.6	-	-	A
Minimum Load Current (Note 4)	AP1086-XXX	$0^\circ\text{C} \leq T_J \leq 125^\circ\text{C}$	-	5	10	mA
Thermal Regulation	$T_A = 25^\circ\text{C}$, 30ms pulse		-	0.008	0.04	%/W
Ripple Rejection	$f = 120\text{Hz}$, $C_{OUT} = 25\mu\text{F}$ Tantalum, $I_{OUT} = 1.5\text{A}$					
	AP1086-XXX	$V_{IN} = V_{OUT} + 3\text{V}$	-	60	70	dB
RMS Noise (% of V_{OUT})	$10\text{Hz} \leq f \leq 10\text{KHz}$		-	0.003	-	%
Temperature Stability	$I_O = 10\text{mA}$		-	0.5	-	%
θ_{JA} Thermal Resistance Junction-to-Ambient (No heat sink; No air flow)	TO252-3L TO263-3L TO220-3L		-	101 83 86	-	$^\circ\text{C}/\text{W}$
θ_{JC} Thermal Resistance Junction-to-Case	TO252-3L: Control Circuitry/Power Transistor TO263-3L: Control Circuitry/Power Transistor TO220-3L: Control Circuitry/Power Transistor		-	15 0.65/2.7 0.65/2.7	-	$^\circ\text{C}/\text{W}$

- Notes:
- See thermal regulation specifications for changes in output voltage due to heating effects. Line and load regulation are measured at a constant junction temperature by low duty cycle pulse testing. Load regulation is measured at the output lead = $1/18^\circ$ from the package.
 - Line and load regulation are guaranteed up to the maximum power dissipation of 15W. Power dissipation is determined by the difference in input and output and the output current. Guaranteed maximum power dissipation will not be available over the full input/output range.
 - Quiescent current is defined as the minimum output current required in maintaining regulation. At 12V input/output differential the device is guaranteed to regulate if the output current is greater than 10mA.

Functional Description

Introduction

The AP1086 adjustable or fixed-mode Low Dropout (LDO) regulator is a 3 terminal device which can easily be programmed by internal mask change to any voltages within the range of 1.25V to $V_{IN}-1.4V$. The AP1086 only needs 1.4V differential between V_{IN} and V_{OUT} to maintain output regulation. In addition, the output voltage tolerances are also extremely tight and they include the transient response as part of the specification. For example, Intel VRE specification calls for a total of +/- 100mV including initial tolerance, load regulation and 0 to 1.5A load step.

The AP1086 is specifically designed to meet the fast current transient needs as well as providing an accurate initial voltage, reducing the overall system cost with the need for fewer output capacitors.

Load Regulation

Since the AP1086 is only a 3 terminal device, it is not possible to provide true remote sensing of the output voltage at the load. But it can supply good load regulation by internal feedback bypass the external loss such as adjustable mode.

Stability

The AP1086 requires the use of an output capacitor as part of the frequency compensation in order to make the regulator stable. For most applications a minimum of 10uF aluminum electrolytic capacitor insures both stability and good transient response.

Thermal Design

The AP1086 incorporates an internal thermal shutdown that protects the device when the junction temperature exceeds the maximum allowable junction temperature. Although this device can operate with junction temperatures in the range of 150°C, it is recommended that the selected heat sink be chosen such that during maximum continuous load operation the junction temperature is kept below the temperature.

Layout Consideration

The output capacitors must be located as close to the V_{OUT} terminal of the device as possible. It is recommended to use a section of a layer of the PC board as a plane to connect the V_{OUT} pin to the output capacitors to prevent any high frequency oscillation that may result due to excessive trace inductance.

Typical Performance Characteristics

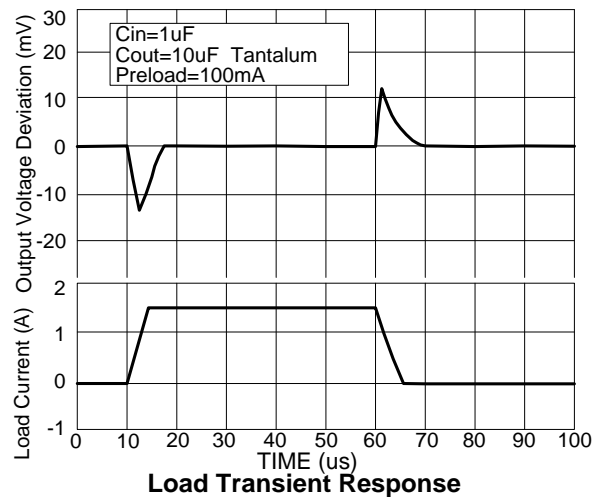
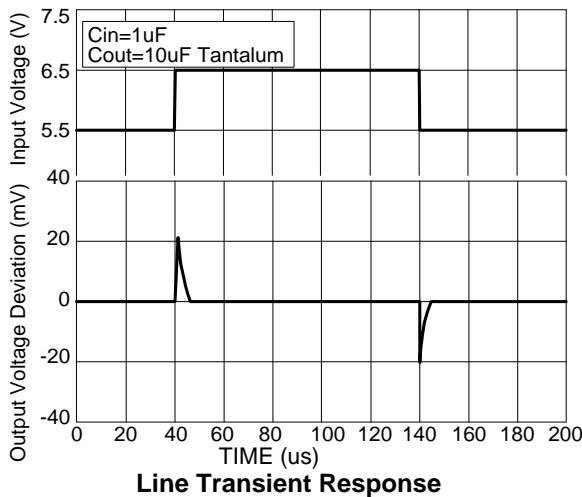
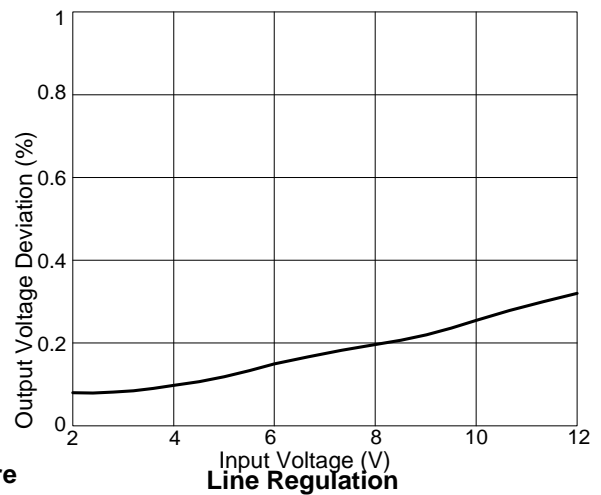

Ordering Information

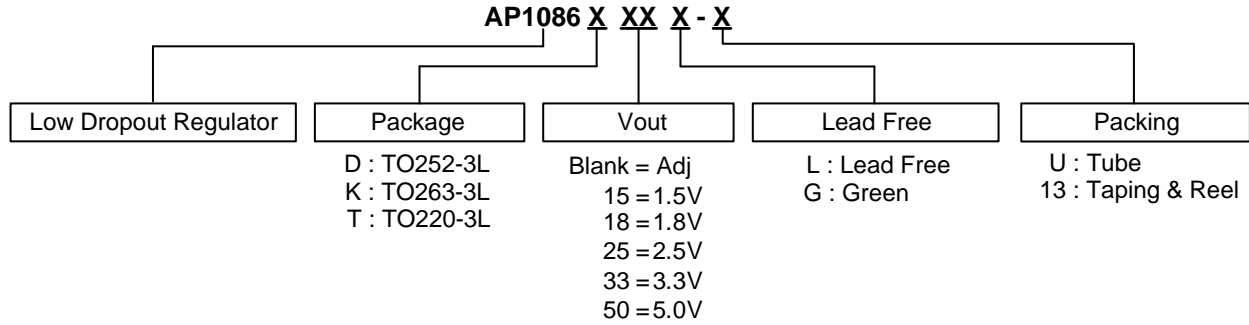

Device	Package Code	Packaging (Note 5)	Tube		13" Tape and Reel	
			Quantity	Part Number Suffix	Quantity	Part Number Suffix
AP1086DXXL-13	D	TO252-3L	NA	NA	2500/Tape & Reel	-13
AP1086DXXG-13	D	TO252-3L	NA	NA	2500/Tape & Reel	-13
AP1086KXXL-13	K	TO263-3L	NA	NA	800/Tape & Reel	-13
AP1086KXXG-13	K	TO263-3L	NA	NA	800/Tape & Reel	-13
AP1086TXXL-U	T	TO220-3L	50	-U	NA	NA
AP1086TXXG-U	T	TO220-3L	50	-U	NA	NA

Notes: 5. Pad layout as shown on Diodes Inc. suggested pad layout document AP02001, which can be found on our website at <http://www.diodes.com/datasheets/ap02001.pdf>.

Marking Information

(1) TO252-3L



(2) TO263-3L



(3) TO220-3L



Package Outline Dimensions (All Dimensions in mm)

(1) Package type: TO252-3L

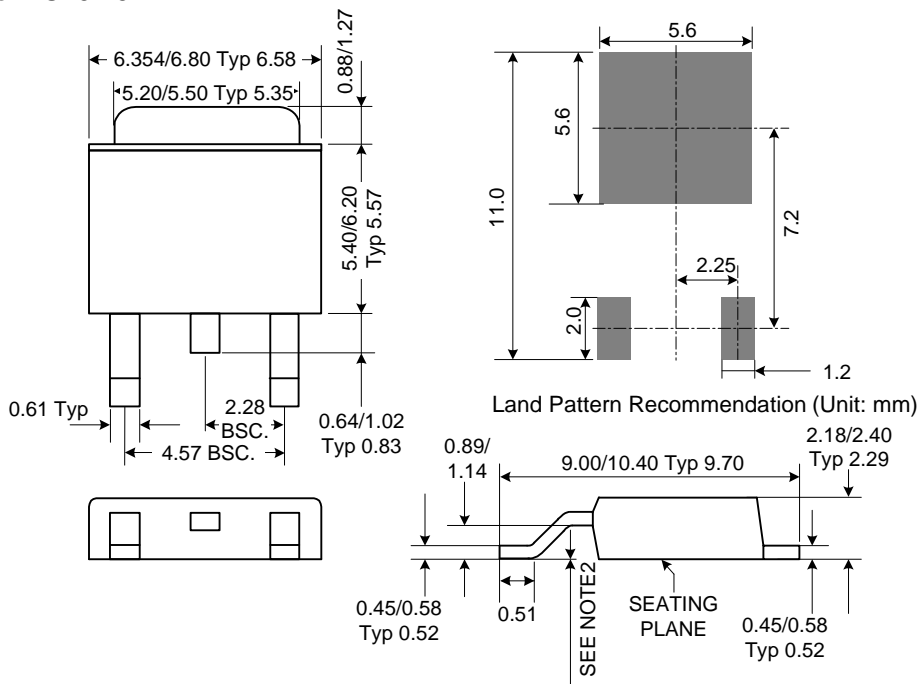

(2) Package type: TO263-3L



Package Outline Dimensions (Continued)

(3) Package type: TO220-3L

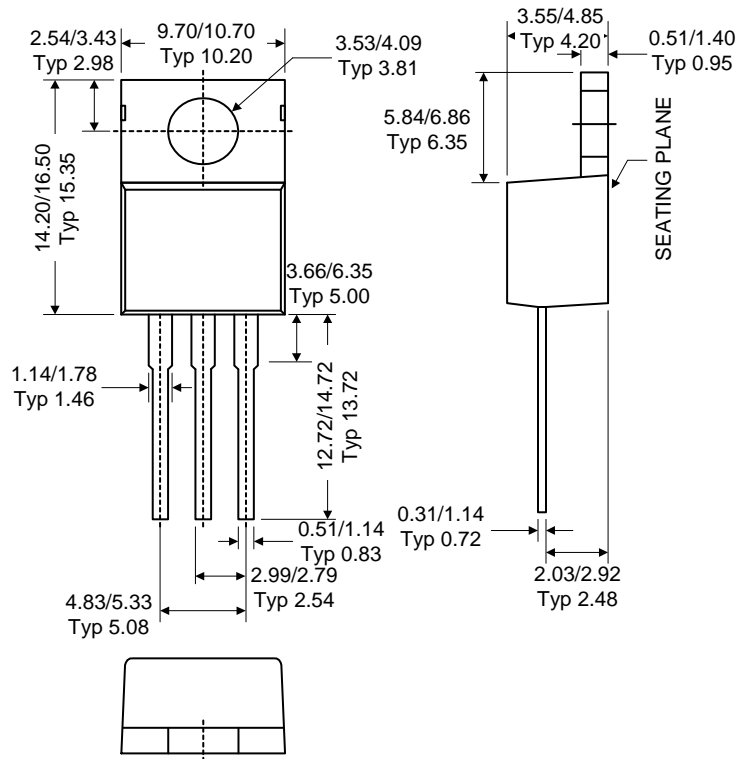

**1.5A LOW DROPOUT POSITIVE ADJUSTABLE OR
FIXED-MODE REGULATOR****IMPORTANT NOTICE**

DIODES INCORPORATED MAKES NO WARRANTY OF ANY KIND, EXPRESS OR IMPLIED, WITH REGARDS TO THIS DOCUMENT, INCLUDING, BUT NOT LIMITED TO, THE IMPLIED WARRANTIES OF MERCHANTABILITY AND FITNESS FOR A PARTICULAR PURPOSE (AND THEIR EQUIVALENTS UNDER THE LAWS OF ANY JURISDICTION).

Diodes Incorporated and its subsidiaries reserve the right to make modifications, enhancements, improvements, corrections or other changes without further notice to this document and any product described herein. Diodes Incorporated does not assume any liability arising out of the application or use of this document or any product described herein; neither does Diodes Incorporated convey any license under its patent or trademark rights, nor the rights of others. Any Customer or user of this document or products described herein in such applications shall assume all risks of such use and will agree to hold Diodes Incorporated and all the companies whose products are represented on Diodes Incorporated website, harmless against all damages.

Diodes Incorporated does not warrant or accept any liability whatsoever in respect of any products purchased through unauthorized sales channel.

Should Customers purchase or use Diodes Incorporated products for any unintended or unauthorized application, Customers shall indemnify and hold Diodes Incorporated and its representatives harmless against all claims, damages, expenses, and attorney fees arising out of, directly or indirectly, any claim of personal injury or death associated with such unintended or unauthorized application.

Products described herein may be covered by one or more United States, international or foreign patents pending. Product names and markings noted herein may also be covered by one or more United States, international or foreign trademarks.

LIFE SUPPORT

Diodes Incorporated products are specifically not authorized for use as critical components in life support devices or systems without the express written approval of the Chief Executive Officer of Diodes Incorporated. As used herein:

A. Life support devices or systems are devices or systems which:

1. are intended to implant into the body, or
2. support or sustain life and whose failure to perform when properly used in accordance with instructions for use provided in the labeling can be reasonably expected to result in significant injury to the user.

B. A critical component is any component in a life support device or system whose failure to perform can be reasonably expected to cause the failure of the life support device or to affect its safety or effectiveness.



Customers represent that they have all necessary expertise in the safety and regulatory ramifications of their life support devices or systems, and acknowledge and agree that they are solely responsible for all legal, regulatory and safety-related requirements concerning their products and any use of Diodes Incorporated products in such safety-critical, life support devices or systems, notwithstanding any devices- or systems-related information or support that may be provided by Diodes Incorporated. Further, Customers must fully indemnify Diodes Incorporated and its representatives against any damages arising out of the use of Diodes Incorporated products in such safety-critical, life support devices or systems.

Copyright © 2010, Diodes Incorporated

www.diodes.com

Looking for pricing, stock, or lifecycle information?

Click below to explore more details on WIN SOURCE:

-  [View AP1086T50L-U on WIN SOURCE](#)
-  [Diodes Incorporated Information](#)

Optimize Your Supply Chain with WIN SOURCE Solutions

-  Global Sourcing Solution
-  Obsolete Management
-  Cost Control Management
-  Shortage Management
-  Alternative Solution
-  Excess Inventory Management