

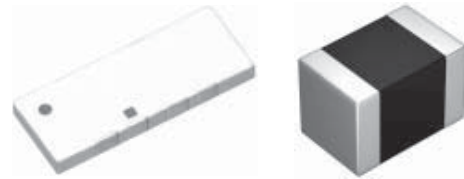

**THE DATASHEET OF
AF116M157502-T**



チップアンテナ CHIP ANTENNA



OPERATING TEMP. -20~+80°C

リフロー/REFLOW

特長 FEATURES

- ・小型・低背
- ・広帯域・高利得
- ・安定した温度特性

- ・ Compact, Lower profile.
- ・ Wide bandwidth, High Gain.
- ・ Stable temperature characteristics.

用途 APPLICATIONS

- ・ Bluetooth®, 無線LAN, GPS

- ・ Bluetooth®, Wireless LAN, GPS

形名表記法 ORDERING CODE

1

形式	
AH	積層アンテナ
AF	ヘリカルアンテナ

2

電極仕様	
△	メッキ品
△=	スペース

3

形状寸法 [mm]	
216	2.5×1.6
116	11.0×1.6
104	10.0×4.0
083	8.0×3.0
122	12.0×2.0
042	4.0×2.0

4

種別コード	
F	逆F
M	モノポール
N	モノポール(デュアルバンド)

5

周波数 [MHz]	
1575	1574.397~1576.443
2450	2400~2500
5250	5150~5350

1. 中心周波数を記載。
2. デュアルバンドは下の周波数。

6

個別仕様	
01~	
S1~	AH 104Fに適用

7

包装	
-T	テーピング

A F △ 2 1 6 M 2 4 5 0 0 1 - T

1 2 3 4 5 6 7

1

Type	
AH	Multilayer Antenna
AF	Helical Antenna

2

Electrode code	
△	With Plating
△=	Blank space

3

Dimensions (case size) [mm]	
216	2.5×1.6
116	11.0×1.6
104	10.0×4.0
083	8.0×3.0
122	12.0×2.0
042	4.0×2.0

4

Special Code	
F	Inverted F
M	Mono Pole
N	Mono Pole (Dual)

5

Frequency [MHz]	
1575	1574.397~1576.443
2450	2400~2500
5250	5150~5350

1. Describe Center Frequency
2. Lower Frequency for Dualband

6

Spec code	
01~	
S1~	applicable to AH 104F

7

Packaging	
-T	Tape & reel

216M Type, 116M Type

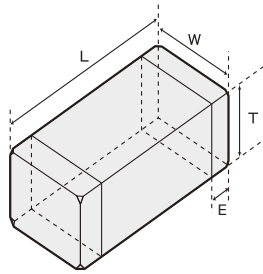

042F Type

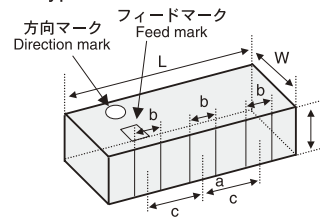

104F Type

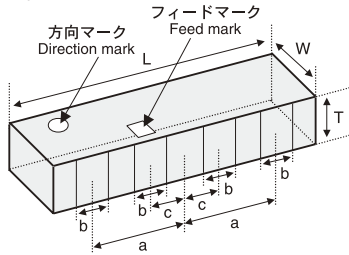

104N Type

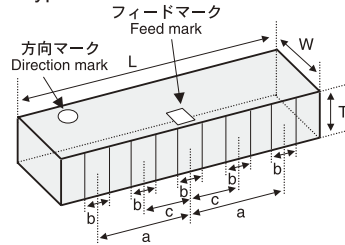

083F Type

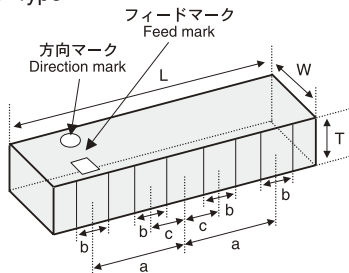

122F Type

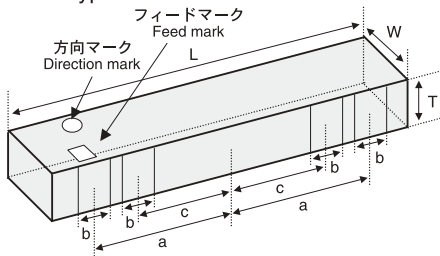

Item	L	W	T	E	a	b	c
216M	2.5±0.2	1.6±0.2	1.6±0.2	0.5±0.3	-	-	-
116M	11.0±0.2	1.6±0.2	1.6±0.2	0.5±0.3	-	-	-
104F	10±0.30	4±0.30	1±0.30	-	2.5±0.30	1±0.30	1±0.30
083F	8±0.30	3±0.30	1±0.30	-	3.1±0.30	1±0.30	1.15±0.30
122F	12±0.30	2±0.30	0.95±0.30	-	5.1±0.30	1±0.30	3.1±0.30
042F	4±0.30	2±0.20	0.8±0.20	-	0±0.30	0.6±0.30	1.3±0.30
104N	10±0.30	4±0.30	1±0.30	-	3±0.30	0.8±0.30	1.5±0.30

Unit : mm

アイテム一覧・電気的特性・代表特性 Part Numbers・Electrical Characteristics・Typical Characteristics

弊社標準基板上での代表的な特性例
Typical Characteristics on Taiyo Yuden evaluation board

Item	EHS (Environmental Hazardous Substances)	Center Frequency (MHz)	Peak Gain	Bandwidth
216M	RoHS	2450 (TYP)	+1dBi	300MHz以上 (VSWR=2以下)
116M	RoHS	1575 (TYP)	+1dBi	120MHz以上 (VSWR=2以下)
104F Series	RoHS	2250 (TYP)	+2dBi 代表例	300MHz以上 (VSWR=2以下) 代表例
		2350 (TYP)		
		2450 (TYP)		
		2550 (TYP)		
		2650 (TYP)		
083F Series	RoHS	2310 (TYP)	+2dBi 代表例	145MHz以上 (VSWR=3以下) 代表例
		2380 (TYP)		
		2450 (TYP)		
		2520 (TYP)		
		2590 (TYP)		
122F Series	RoHS	2290 (TYP)	+1dBi 代表例	200MHz以上 (VSWR=3以下) 代表例
		2370 (TYP)		
		2450 (TYP)		
		2520 (TYP)		
042F	RoHS	2600 (TYP)	+1dBi	240MHz以上 (VSWR=2以下)
		5250 (TYP)		
104N	RoHS	2450 (TYP)	0dBi	530MHz以上 (VSWR=2以下)
		5400 (TYP)	-1dBi	1.3GHz以上 (VSWR=2以下)

セクションガイド
Selection Guide

アイテム一覧
Part Numbers

特性図
Electrical Characteristics

梱包
Packaging

信頼性
Reliability Data

使用上の注意
Precautions



etc

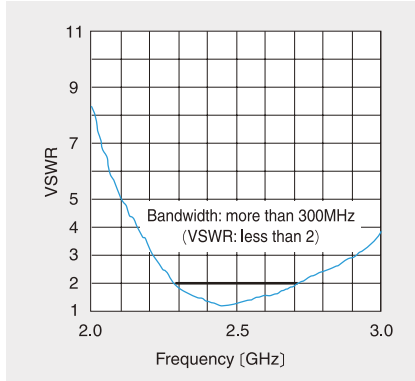

VSWR特性の代表例 (216M)
Typical characteristics of VSWR (216M)

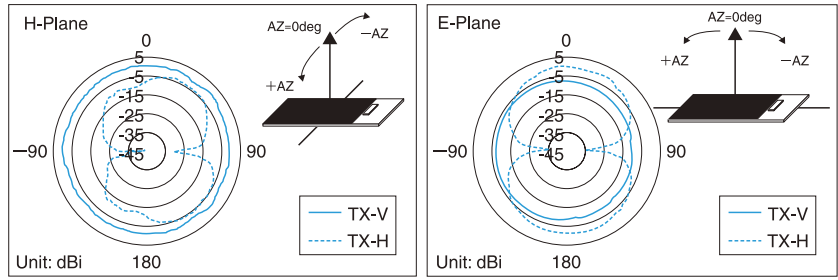

指向性の代表例 (216M @2.45GHz)
Typical characteristics of radiation pattern (216M @2.45GHz)

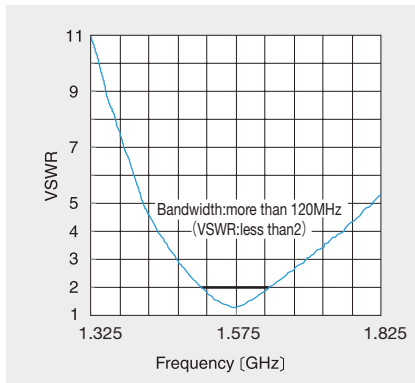

VSWR特性の代表例 (116M)
Typical characteristics of VSWR (116M)

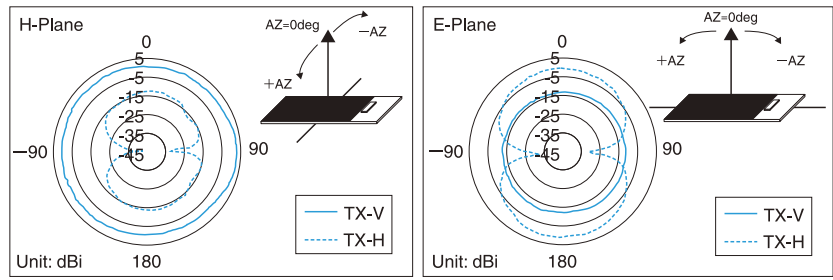

指向性の代表例 (116M @1.575GHz)
Typical characteristics of radiation pattern (116M @1.575GHz)

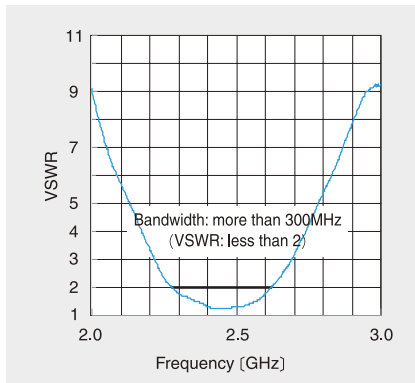

VSWR特性の代表例 (104Fシリーズ)
Typical characteristics of VSWR (104F series)

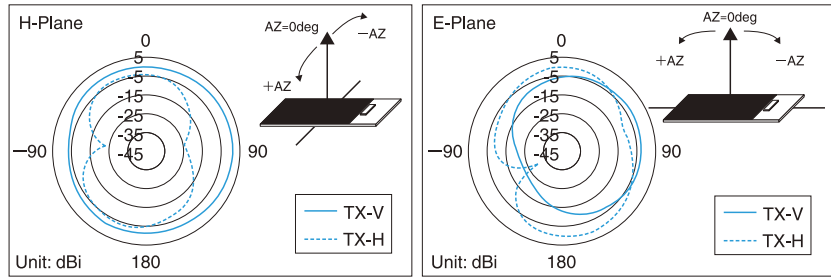

指向性の代表例 (104Fシリーズ @2.45GHz)
Typical characteristics of radiation pattern (104F series @2.45GHz)

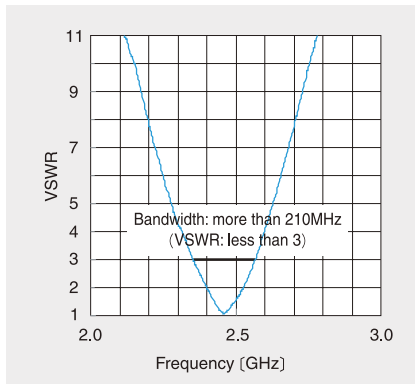

VSWR特性の代表例 (083Fシリーズ)
Typical characteristics of VSWR (083F series)

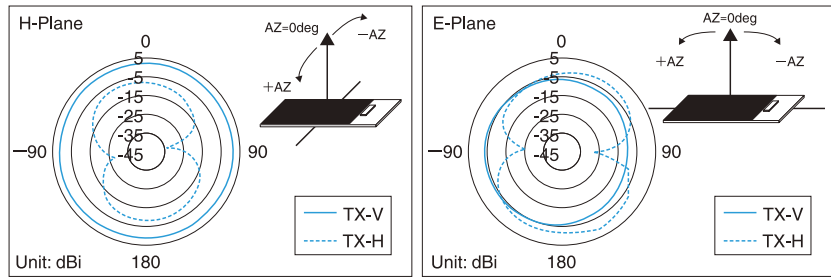

指向性の代表例 (083Fシリーズ @2.45GHz)
Typical characteristics of radiation pattern (083F series @2.45GHz)

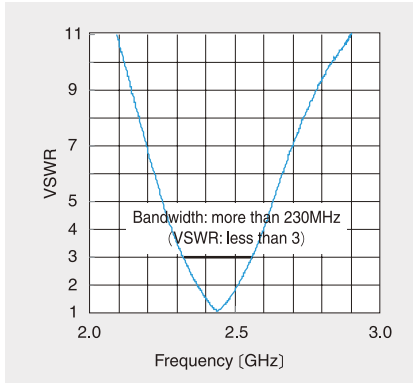

VSWR特性の代表例 (122Fシリーズ)
Typical characteristics of VSWR (122F series)

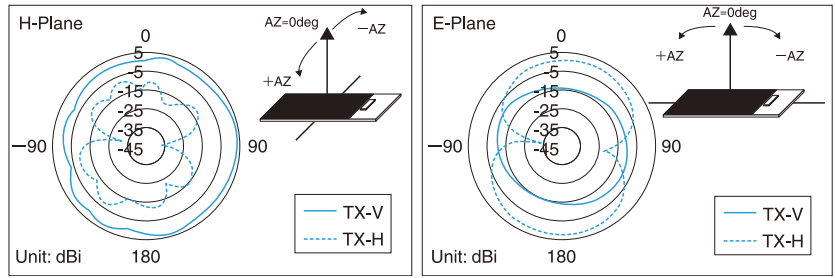

指向性の代表例 (122Fシリーズ @2.45GHz)
Typical characteristics of radiation pattern (122F series @2.45GHz)

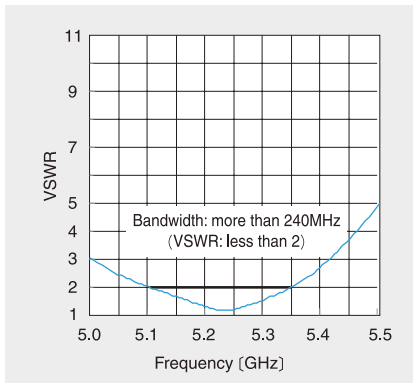

VSWR特性の代表例 (042F)
Typical characteristics of VSWR (042F)

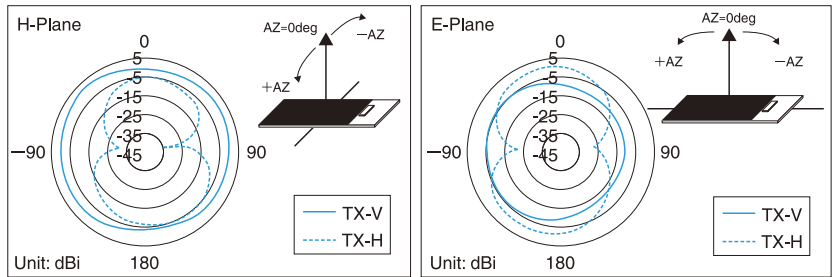

指向性の代表例 (042F @5.25GHz)
Typical characteristics of radiation pattern (042F @5.25GHz)

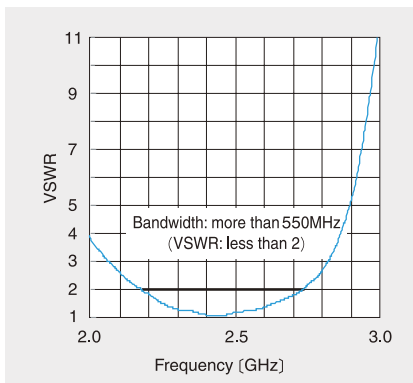

VSWR特性の代表例 (104N 2GHz帯)
Typical characteristics of VSWR (104N 2GHz band)

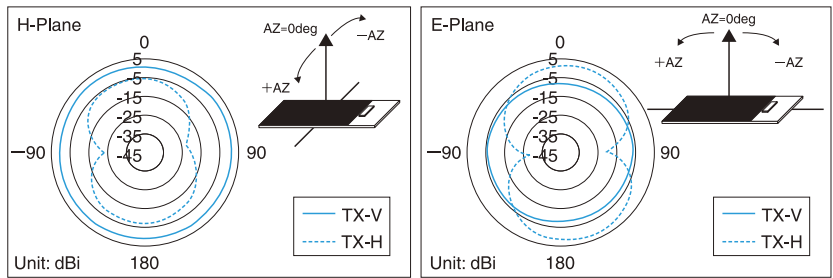

指向性の代表例 (104N @2.45GHz)
Typical characteristics of radiation pattern (104N @2.45GHz)

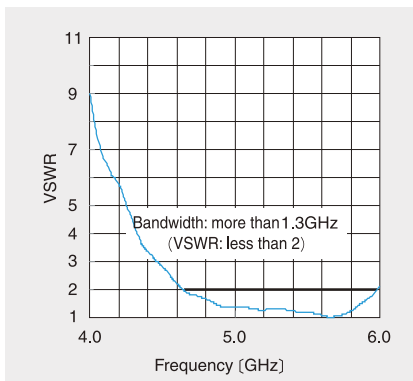

VSWR特性の代表例 (104N 5GHz帯)
Typical characteristics of VSWR (104N 5GHz band)

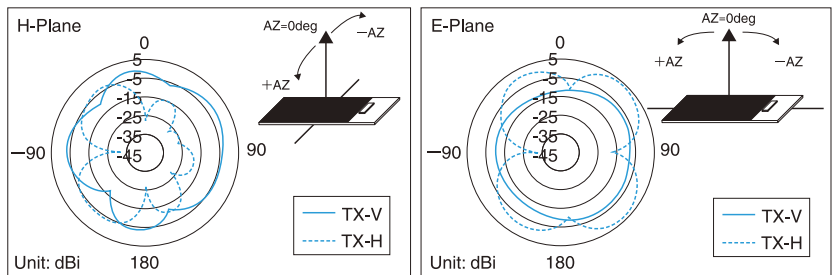

指向性の代表例 (104N @5.4GHz)
Typical characteristics of radiation pattern (104N @5.4GHz)

①最小受注単位数 Minimum Quantity

形式 Type	エンボステープ [pcs] Embossed Tape
216M, 116M 104F, 122F, 042F, 104N 083F	2000
083F	1000

②テーピング材質 Tape Material

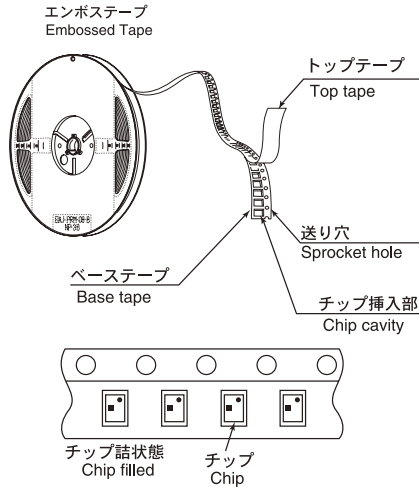

④リーダー部・空部 Leader and Blank portion

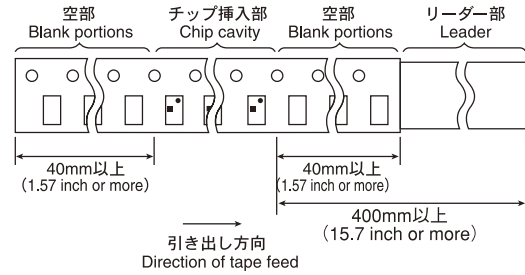

⑤リール寸法 Reel size

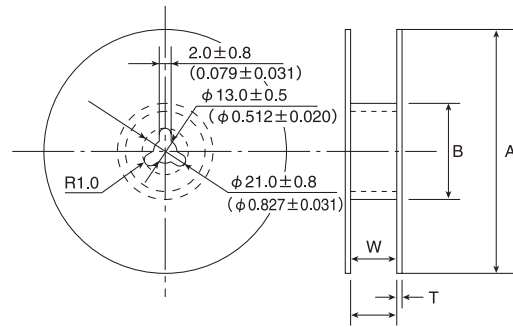

■テーピング梱包 Taped packaging

形式 (EIA) Type	製品厚みThickness mm (inch)	標準数量 Standard quantity [pcs] エンボステープ Embossed tape
216M,116M	1.6typ.(0.063)	2000
104F, 122F, 104N	1.00typ.(0.040)	2000
083F	1.00typ.(0.040)	1000
042F	0.8typ.(0.031)	2000

Type	A	B	W	T
216M	178±2.0 (7.0±0.08)	50MIN (2.0)	10±1.5 (0.394±0.06)	3.0MAX (0.12)
116M,104F, 122F,104N	330±2.0 (13.0±0.08)	100±1.0 (3.94±0.04)	25.5±1 (1.0±0.04)	3.0MAX (0.12)
083F	178±2.0 (7.0±0.08)	50MIN (2.0)	17.0±1 (0.67±0.04)	2.5MAX (0.1)
042F	178±2.0 (7.0±0.08)	50MIN (2.0)	14.0±1 (0.55±0.04)	2.5MAX (0.1)

Unit : mm (inch)

③テーピング寸法 Taping dimensions

エンボステープ (8mm幅) Embossed tape (0.315 inches wide)

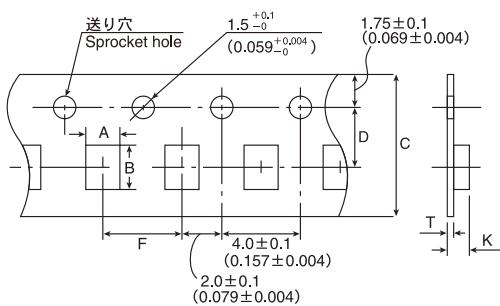

⑥トップテープ強度 Top Tape Strength

トップテープのはがし力は下図矢印方向にて0.1~0.7Nとなります。

The top tape requires a peel-off force of 0.1~0.7N in the direction of the arrow as illustrated below.

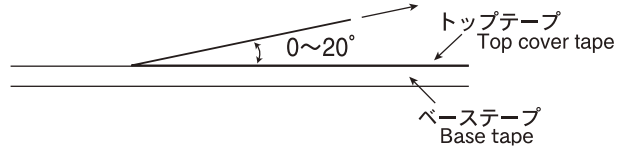

Type	チップ挿入部 Chip cavity		テープ幅 Tape Widthness		挿入ピッチ Insertion Pitch	テープ厚みMAX Tape Thickness	
	A	B	C	D		K	T
216M	1.85±0.2 (0.073±0.008)	2.75±0.2 (0.108±0.008)	8±0.2 (0.315±0.008)	3.5±0.1 (0.138±0.004)	4±0.1 (0.157±0.004)	1.95 (0.077)	0.3 (0.012)
116M	1.95±0.2 (0.077±0.008)	11.4±0.2 (0.449±0.008)	24±0.3 (0.945±0.012)	11.5±0.1 (0.435±0.004)	4±0.1 (0.157±0.004)	2.05 (0.081)	0.35 (0.014)
104F,104N	4.35±0.2 (0.171±0.008)	10.35±0.2 (0.407±0.008)	24±0.3 (0.945±0.012)	11.5±0.1 (0.435±0.004)	8±0.1 (0.315±0.004)	1.45 (0.057)	0.3 (0.012)
122F	2.3±0.2 (0.091±0.008)	12.3±0.2 (0.484±0.008)	24±0.3 (0.945±0.012)	11.5±0.1 (0.435±0.004)	4±0.1 (0.157±0.004)	1.35 (0.053)	0.35 (0.014)
083F	3.35±0.2 (0.132±0.008)	8.35±0.2 (0.329±0.008)	16±0.3 (0.630±0.012)	7.5±0.1 (0.295±0.004)	8±0.1 (0.315±0.004)	1.45 (0.057)	0.3 (0.012)
042F	2.3±0.2 (0.091±0.008)	4.3±0.2 (0.169±0.008)	12±0.2 (0.473±0.008)	5.5±0.1 (0.217±0.004)	4±0.1 (0.157±0.004)	1.15 (0.045)	0.3 (0.012)

Unit : mm (inch)

Item	Specified Value	Test Methods and Remarks
1. Operating Temperature Range	-20~+80°C	
2. Storage Temperature Range	-40~+85°C	※with being taped, -20~+35°C
3. Solderability	At least 90% of Terminal surface immersed is covered by new solder.	Solder temperature : 230±5°C Duration : 3±1 sec. Preconditioning : Preheating at 150°C after immersion into flux.
4. Thermal shock	shall satisfy required VSWR value of individual specifications for each item.	1 hour of recovery after 10 times of 30min.immersion alternately at -40°C and 85°C of temperature, followed by evaluating electrical characteristics.
5. High Temperature Storage Test	shall satisfy required VSWR value of individual specifications for each item.	1 hour of recovery under standard condition after 96 hours recovery with 85°C of temperature, followed by evaluating electrical characteristics.
6. Low Temperature Storage Test	shall satisfy required VSWR value of individual specifications for each item.	1 hour of recovery under standard condition after 96 hours recovery with -40°C of temperature, followed by evaluating electrical characteristics.
7. Humidity Storage Test	shall satisfy required VSWR value of individual specifications for each item.	1 hour of recovery under standard condition after 96 hours recovery with 60°C of temperature, 90~95% relative humidity followed by evaluating electrical characteristics.
8. Resistance to Reflow	shall satisfy required VSWR value of individual specifications for each item.	Two times of Reflow soldering by recommended profile attached, followed by evaluating electrical characteristics.

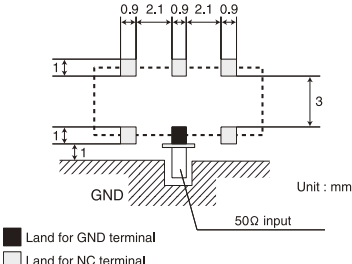
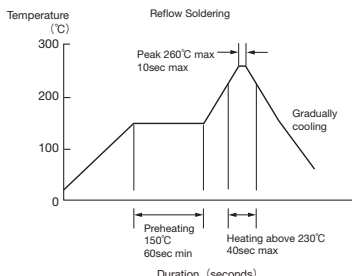
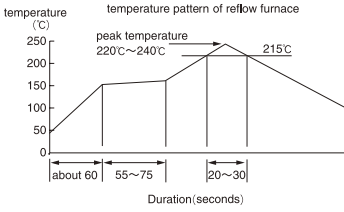
Stages	Precautions	Technical considerations
1. PCB Design		 <p>Unit : mm</p> <p>Recommended antenna land pattern for 104N</p>
2. Soldering		<p>Conditions of Reflow soldering (for reference)</p> <p><u>Pb Free Reflow Profile</u></p>  <p>※Components should be preheated to within 100 to 130°C from soldering temperature. ※Assured to be reflow soldering for 2 times.</p> <p>Note : The above profiles are the maximum allowable soldering condition, therefore these profiles are not always recommended.</p> <p><u>Reflow Profile</u></p> 
3. Storage conditions	<p>◆ Storage conditions</p> <ol style="list-style-type: none"> The Products should not be used in the following environments : <ul style="list-style-type: none"> • exposure to special gases such as (C12, NH3, SOx, NOx) • exposure to volatile gas or inflammable gas • exposure to a lot of dust • exposure to water or condensation • exposure to direct sunlight or freezing The Products should be kept in the following conditions : <ul style="list-style-type: none"> • Temperature : - 10 ~ + 40°C • Humidity : 15 ~ 85% RH The products should be used within 6 months after delivery. In case of storage over 6 months, solderability shall be checked before actual usage. 	

■ Please contact our offices for further details of specifications.
 All of the standard values listed here are subject to change without notice due to technical improvements.
 Therefore, please check the specifications carefully before use.

Looking for pricing, stock, or lifecycle information?

Click below to explore more details on WIN SOURCE:

 [View AF116M157502-T on WIN SOURCE](#)

 [Taiyo Yuden Information](#)

Optimize Your Supply Chain with WIN SOURCE Solutions

-  Global Sourcing Solution
-  Obsolete Management
-  Cost Control Management
-  Shortage Management
-  Alternative Solution
-  Excess Inventory Management