

Mounting hardware and accessories

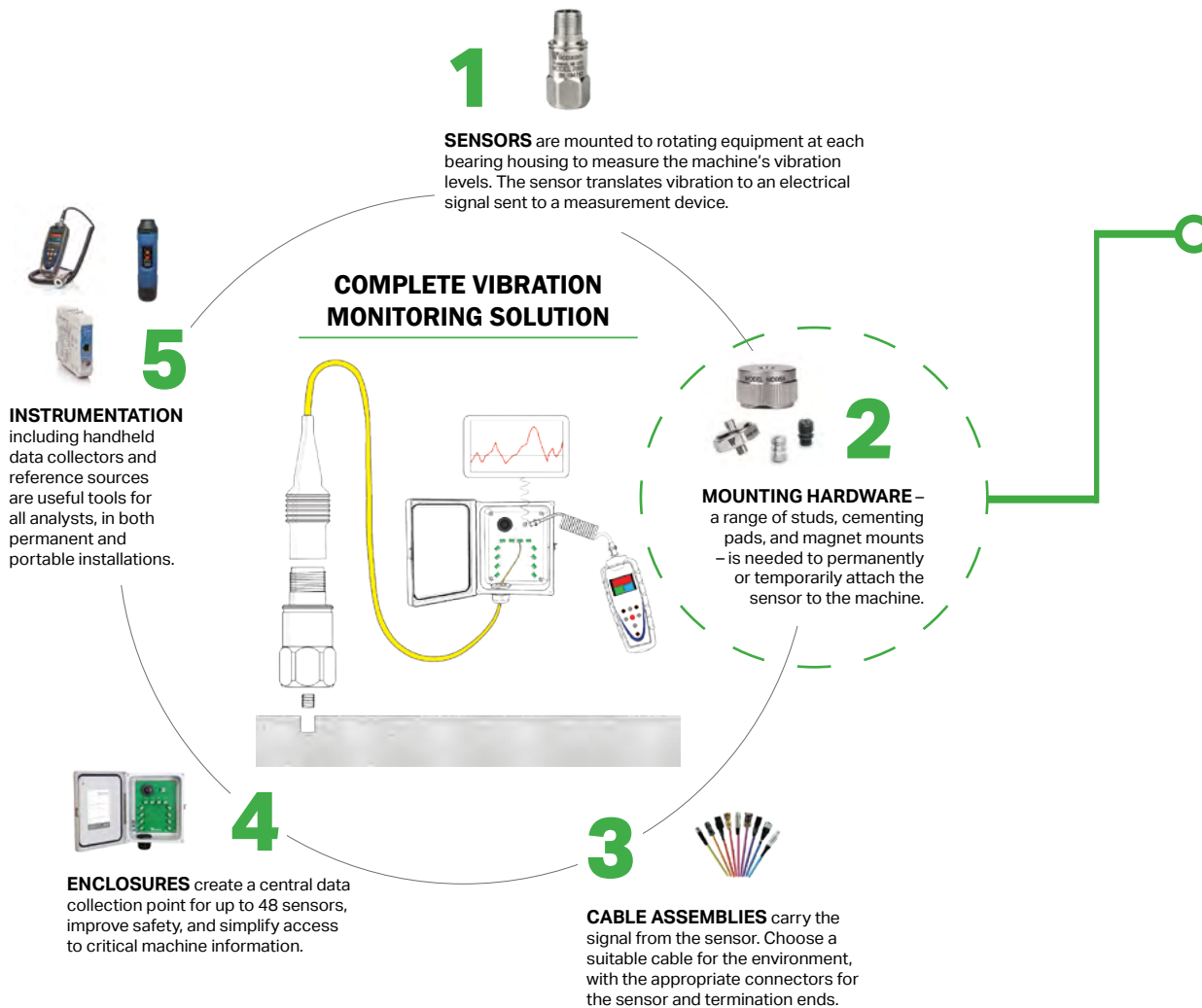

A full range of mounting hardware for industrial applications



Wilcoxon offers complete vibration monitoring solutions for permanent sensor installations or walkaround monitoring. Permanent sensors offer consistency and simplified access to data, while temporary installations allow greater flexibility, usually at a lower cost.

The best monitoring approach will vary depending on the application, but in any installation, proper sensor mounting is crucial for reliable data. We offer the full range of tools you need and the expertise you can rely on to get the job done.

Mounting considerations

The best mounting configuration depends on the machine being monitored, the type and location of the sensor, the frequency range of interest, and whether the mount will be permanent or temporary. The most important considerations are dynamic measurement requirements, such as frequency response and amplitude.

Frequency range

The mounting location of each sensor should be based on the characteristics of the machinery to be monitored. The dynamic measurement requirements of frequency response and amplitude should be evaluated against the frequency range of the mounting method. Each mounting method has a different effect on a sensor's operating frequency range.

Accelerometers have a natural resonance 2 to 5 times higher than the data sheet specified upper-end frequency response. The goal of measurement is to utilize the flat portion of the frequency response (the portion between the upper and lower 3 dB limit) for the best characterization of vibration levels. To ensure optimal response, careful attention should be made to the contact surface area and the proximity to the actual source of the vibration. The closer the contact between sensor and machine, the better the ability to couple and measure high frequencies.

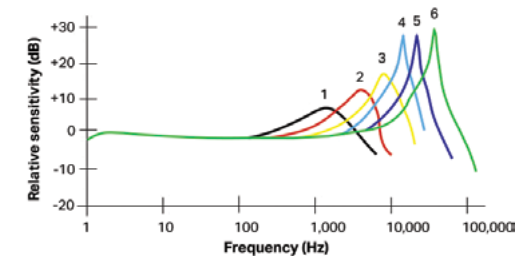
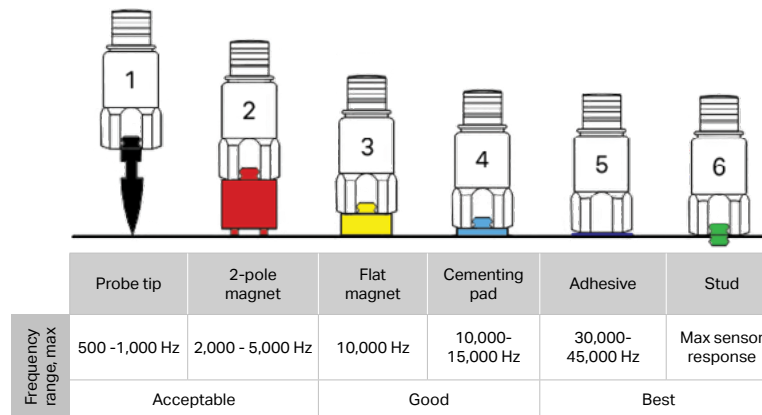

Surface

Wilcoxon's rugged sensors are designed to operate continuously in harsh industrial environments. Consideration of mounting surface and wiring requirements will ensure optimal performance of the sensor throughout the lifetime of the machinery being monitored. The accuracy of high frequency signals is dependent on how direct and rigid the contact is between the sensor and the machine. Adequately preparing the mounting surface provides the best performance and output of reliable data ensuring an accurate assessment of machine condition.

Tips:

- » Mount sensors in a location that minimizes the vibration transmission route from the driving point source of vibration (shaft) through the machine to the sensor. This is most often the bearing casing
- » Avoid mounting the sensor on thin sections, guards or vibration-free areas (antinodes), or areas with extreme temperature variations
- » Use a silicon grease to increase the performance of permanently mounted sensors

Permanent mounting solutions

For permanent installations, the sensor can be mounted on the machine with mounting studs or cementing pads. To help you get the most accurate, reliable measurements in any conditions, Wilcoxon offers a wide selection of hardware.



Mounting studs

Stud mounting is the most reliable mounting option because it can achieve the sensor's maximum frequency range and is highly recommended for permanent monitoring systems, high-frequency testing and harsh environments.

Top-exit sensors are installed by using a double-ended stud. One end is inserted into a threaded hole in the base of the sensor, and the other end is inserted into a properly prepared threaded hole in the machinery. Side-exit sensors are installed by using a captive screw that runs through the body of the sensor and exposes the threads underneath the base, which can be threaded directly into the machine. Wilcoxon offers the ST101 spot face tool for fast and easy surface preparation.

Tips:

- » Torque to specification to avoid inaccurate frequency response, poor coupling and/or sensor damage
- » Avoid small debris between sensor and surface, as it can dramatically reduce the upper frequency response limit
- » A thin coating of silicone grease can increase mounting stiffness and enhance frequency response



	SF1 short mounting stud	SF3 mounting adapter stud	SF3M mounting adapter stud	SF20-1 stud	SF20-2 stud	SF20-M4 captive screw	SF20-M8 stud
Size	0.26 in	0.315 in	0.315 in	0.55 in	0.75 in	0.85 in	0.72 in
Mount	10-32 UNF both ends	10-32 to 1/4-28 threaded hole	10-32 to M8-1.25 threaded hole	1/4-28 to 3/8-24	3/8-24	M4	3/8-24 to M8
Mounting torque	30 in-lb	20 in-lb	20 in-lb	24 in-lb	50 in-lb	24 in-lb	24 in-lb
Description	Stainless steel	Stainless steel	Stainless steel with black oxide coating	Stainless steel	Stainless steel	For 712F and 997 sensors	Black oxide coating

Mounting studs



	SF6 mounting stud	SF6M mounting stud	SF6M-1 mounting stud	SF7 mounting stud	SF7B adapter stud
Size	0.375 in	0.53 in	0.39 in	0.83 in	0.33 in
Mount	1/4-28 both ends	1/4-28 to M8	1/4-28 to M6	3/8-16 thread both ends	1/4-28 internal to 3/8-16 external
Mounting torque	24 in-lb	24 in-lb	24 in-lb	30 in-lb	24 in-lb
Description	Stainless steel	Stainless steel with black oxide coating	Stainless steel with black oxide coating	Stainless steel, recommended for ring mode accelerometers	Threaded (helical) inserts

Cementing pads

Cementing pads should be used when the structure to be monitored cannot be drilled. When installed properly, they provide high frequency capability approaching stud mounts. They are often used in applications where multiple locations will be measured using a single sensor. Mounting pads can also be used when multiple sensors are mounted for short periods of time, and directly epoxying the sensor is not practical.

Adhesive mounting provides a secure attachment and is the next best alternative to stud mounting. The sensor's operational frequency range will be reduced because the adhesive acts as a shock absorber, introducing a lower resonance than stud mounting. Replacement or removal of adhesive mounted sensors is more difficult than other mounting methods. Avoid rubbery or sticky adhesives, and ensure that the adhesive layer is as thin and rigid as possible.



	SF8	SF8-2	SF8-8	SF8M-9	SF20-3 cementing pad	SF5 epoxy mounting stud	SF11 magnet landing pad
Size	1.0 in	1.0 in	1.0 in	1.0 in	1.0 in	0.5 in hex	1.0 in
Mount	1/4-28 integral stud	1/4-28 tapped hole	10-32 tapped hole	M6 tapped hole	3/8-24 integral stud	10-32 integral stud	-
Mounting torque	24 in-lb	24 in-lb	24 in-lb	24 in-lb	50 in-lb	18 in-lb	-
Description	Stainless steel	Keyed	Keyed for use with 993B sensor	Stainless steel	Stainless steel	Stainless steel with black oxide coating	Stainless steel type 416 magnetic target

Isolator mounting bases

Wilcoxon's SF2X series mounting bases electrically isolate the sensor from the case of the machine, providing protection from up to 1,500 volts of electricity. The isolators are corrosion resistant and can withstand temperatures up to 180°C. The sensor is protected against high voltage, static electricity build-up, ESD shocks and grounding issues such as poor ground bonding, ground loops or different ground potential. Ensure all contaminants are removed from isolation material to avoid conduction, and use a thin, rigid layer of adhesive.



	SF21	SF22	SF23	SF24
Length across flats	1.0 in	1.0 in	1.125 in	1.125 in
Diameter	0.82 in	0.82 in	0.94 in	0.94 in
Mount	1/4-28 to 1/4-28	1/4-28 to M8-1.25	1/4-28 to 1/4-28	1/4-28 to M8-1.25
Mounting torque	24 in-lb	24 in-lb	24 in-lb	24 in-lb

Triaxial mounting cubes

Three accelerometers can be mounted to the TC series cubes to measure vibration along three orthogonal directions (x,y,z). The cubed design allows free alignment of the x and y axes.



	TC1	TC1B	TC2
Size	1.0 in	1.0 in	2.6 in
Weight	1.27 oz	1.27 oz	17.64 oz
Mount	10-32	1/4-28	3/8-16
Description	Anodized aluminum, non-conductive coating prevents ground loops	Anodized aluminum, non-conductive coating prevents ground loops	Anodized aluminum, non-conductive coating prevents ground loops. Use with 731A sensor

Temporary mounting solutions

Magnetic bases are a quick and convenient option for walkaround applications, and are often used on large machinery. They can be quickly attached and removed on both flat and curved surfaces. All Wilcoxon magnets are designed with corrosion resistant stainless steel casings for use in harsh environments.



Magnetic mounting bases

Magnetic bases produce a significantly different response at higher frequencies compared to stud and cementing pad measurements. The most significant disadvantage is the lower resonant frequency of the coupled system. Due to the higher mass, caution must be exercised when viewing data higher than 1 kHz. The added mass may affect the measurement of very light structures due to mass loading.

Tips:

- » Coupling fluids such as oil greatly improve measurements with flat bottom magnets and should be used whenever possible
- » For accurate trending, mark measurement locations to ensure readings are taken at the same place every time



Curved surfaces		MD035	MD055	MD130
	Pull strength	35 lbf	55 lbf	130 lbf
	Diameter	1.00 in	1.25 in	2.00 in
	Height	0.78 in	0.76 in	1.10 in
	Thread	1/4-28	1/4-28	1/4-28



Flat surfaces		MF040	MF075	MF120
	Pull strength	50 lbf	75 lbf	120 lbf
	Diameter	1.00 in	1.25 in	1.50 in
	Height	0.50 in	0.50 in	0.60 in
	Thread	1/4-28	1/4-28	1/4-28



Triaxial sensors		MT075	MT075A
	Pull strength	75 lbf	75 lbf
	Diameter	1.50 in	1.50 in
	Height	0.75 in	0.75 in
	Thread	1/4-28	10-32

Note: All M-series magnets are non-isolated.

Specialty mounting

Fin mounts

The FM series is designed to be epoxied or welded between cooling fins of large electric motors. Fin mounts are typically used on non-drive locations where cooling fan shrouds prevent monitoring on the end belt.



	FM101	FM102	FM103	FM104
Diameter	0.50 in	0.50 in	0.25 in	0.25 in
Height	1.25 in	2.00 in	1.75 in	1.00 in

QuickLINK mounting

QuickLINK mounting pads reduce collection time during walkaround monitoring applications. They offer the speed of magnetic mounting and the measurement reliability of permanent installations.



	QB-1 sensor adaptor	QP-1 mounting pad	QP-2 cementing pad
Diameter	1.0 in	1.0 in	1.0 in
Mount	1/4-28	1/4-28 tapped hole base	flat base
Mounting torque	24 in-lb	24 in-lb	-

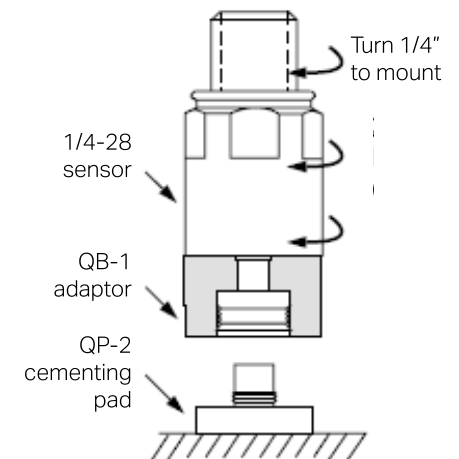

Additional accessories



Mounting grease

The acid and alkaline resistant SILGREASE can be used to assist in temporary walkaround mounting applications. The non-toxic grease is USDA approved for use in the food and beverage industry. It offers radiation resistance and is electrically insulating, even in moist environments.



Spot face tool

The ST101 includes an integral pilot drill for creating 1/4-28 tapped holes. It can be used in either portable or bench mounted drills to produce a high grade flat surface suitable for stud mounting accelerometers with 1/4-28 or M6 threads.



Mounting epoxy

Adhesive or glue mounting provides a secure attachment without extensive machining but can reduce the operational frequency range since the adhesive acts like a shock absorber, known as damping. VERSIL406 epoxy can be used for flat surface mounting applications in areas up to 150°C. The two-part epoxy has a 5 minute working time, and one packet provides sufficient adhesive for mounting 5-7 bases.



Probe tip

The PT2 can be used to take readings of hard to reach areas or on surfaces that are not conducive to mounting. The probe tip is a faster method for acquiring valid data when the frequency of measurement is less than 200 Hz. It easily connects to any vibration meter via 1/4-28 mounting hole.

All Wilcoxon mounting accessories are backed by lifetime warranty. To shop online, go to buy.wilcoxon.com.



info@wilcoxon.com



wilcoxon.com
buy.wilcoxon.com



+1 (301) 330-8811



Wilcoxon Sensing Technologies



@WilcoxonSensing



An Amphenol Company

Looking for pricing, stock, or lifecycle information?

Click below to explore more details on WIN SOURCE:

 [View SF23 on WIN SOURCE](#)

 [Amphenol Information](#)

Optimize Your Supply Chain with WIN SOURCE Solutions

-  Global Sourcing Solution
-  Obsolete Management
-  Cost Control Management
-  Shortage Management
-  Alternative Solution
-  Excess Inventory Management