



**THE DATASHEET OF
AOB4184**



AOB4184
40V N-Channel MOSFET
General Description

The AOB4184 uses advanced trench technology and design to provide excellent $R_{DS(ON)}$ with low gate charge. With the excellent thermal resistance of the D²PAK package, this device is well suited for high current load applications.

Features

V_{DS} (V) = 40V
 I_D = 50 A (V_{GS} = 10V)
 $R_{DS(ON)}$ < 10 m Ω (V_{GS} = 10V)
 $R_{DS(ON)}$ < 13 m Ω (V_{GS} = 4.5V)
 100% UIS Tested
 100% Rg Tested

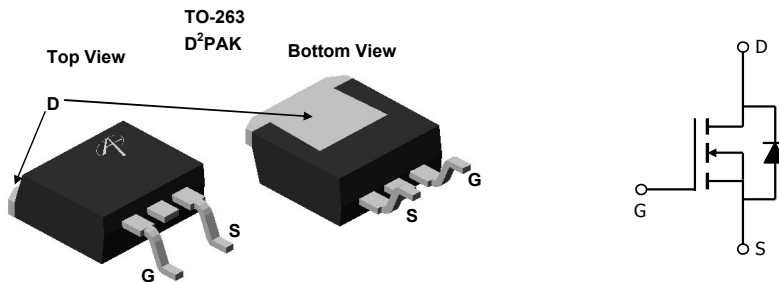
Absolute Maximum Ratings $T_A=25^\circ\text{C}$ unless otherwise noted

Parameter	Symbol	Maximum	Units
Drain-Source Voltage	V_{DS}	40	V
Gate-Source Voltage	V_{GS}	± 20	V
Continuous Drain Current ^G	I_D	$T_C=25^\circ\text{C}$	50
		$T_C=100^\circ\text{C}$	40
Pulsed Drain Current ^C	I_{DM}	120	A
Continuous Drain Current ^A	I_{DSM}	$T_C=25^\circ\text{C}$	12
		$T_C=70^\circ\text{C}$	10
Avalanche Current ^C	I_{AS}, I_{AR}	35	A
Avalanche energy $L=100\mu\text{H}$ ^C	E_{AS}, E_{AR}	61	mJ
Power Dissipation ^B	P_D	$T_C=25^\circ\text{C}$	50
		$T_C=100^\circ\text{C}$	25
Power Dissipation ^A	P_{DSM}	$T_A=25^\circ\text{C}$	2.5
		$T_A=70^\circ\text{C}$	1.6
Junction and Storage Temperature Range	T_J, T_{STG}	-55 to 175	$^\circ\text{C}$

Thermal Characteristics

Parameter	Symbol	Typ	Max	Units
Maximum Junction-to-Ambient ^A	$R_{\theta JA}$	11	17	$^\circ\text{C}/\text{W}$
Maximum Junction-to-Ambient ^A				
Maximum Junction-to-Case ^B	$R_{\theta JC}$	2.4	3	$^\circ\text{C}/\text{W}$

Electrical Characteristics (T_J=25°C unless otherwise noted)

Symbol	Parameter	Conditions	Min	Typ	Max	Units
STATIC PARAMETERS						
BV _{DSS}	Drain-Source Breakdown Voltage	I _D =250μA, V _{GS} =0V	40			V
I _{DSS}	Zero Gate Voltage Drain Current	V _{DS} =40V, V _{GS} =0V T _J =55°C			1 5	μA
I _{GSS}	Gate-Body leakage current	V _{DS} =0V, V _{GS} =±20V			±100	nA
V _{GS(th)}	Gate Threshold Voltage	V _{DS} =V _{GS} , I _D =250μA	1.7	2.1	3	V
I _{D(ON)}	On state drain current	V _{GS} =10V, V _{DS} =5V	120			A
R _{DS(ON)}	Static Drain-Source On-Resistance	V _{GS} =10V, I _D =20A		8.5	10	mΩ
		T _J =125°C		13.2	17	
		V _{GS} =4.5V, I _D =20A		10	13	mΩ
g _{FS}	Forward Transconductance	V _{DS} =5V, I _D =20A		100		S
V _{SD}	Diode Forward Voltage	I _S =1A, V _{GS} =0V		0.72	1	V
I _S	Maximum Body-Diode Continuous Current ^G				30	A
DYNAMIC PARAMETERS						
C _{iss}	Input Capacitance	V _{GS} =0V, V _{DS} =20V, f=1MHz	1250	1500	1800	pF
C _{oss}	Output Capacitance		165	215	280	pF
C _{riss}	Reverse Transfer Capacitance		95	135	190	pF
R _g	Gate resistance	V _{GS} =0V, V _{DS} =0V, f=1MHz	2	3.5	5	Ω
SWITCHING PARAMETERS						
Q _g (10V)	Total Gate Charge	V _{GS} =10V, V _{DS} =20V, I _D =20A	22	27.2	35	nC
Q _g (4.5V)	Total Gate Charge		11	13.6	18	nC
Q _{gs}	Gate Source Charge		3.5	4.5	6	nC
Q _{gd}	Gate Drain Charge		4.5	6.4	9	nC
t _{D(on)}	Turn-On DelayTime	V _{GS} =10V, V _{DS} =20V, R _L =1Ω, R _{GEN} =3Ω		6.4		ns
t _r	Turn-On Rise Time			17.2		ns
t _{D(off)}	Turn-Off DelayTime			29.6		ns
t _f	Turn-Off Fall Time			16.8		ns
t _{rr}	Body Diode Reverse Recovery Time		I _F =20A, dI/dt=500A/μs	15	19	25
Q _{rr}	Body Diode Reverse Recovery Charge	I _F =20A, dI/dt=500A/μs	48	59	78	nC

A: The value of R_{θJA} is measured with the device mounted on 1in² FR-4 board with 2oz. Copper, in a still air environment with T_A=25°C. The Power dissipation P_{DSM} is based on R_{θJA} and the maximum allowed junction temperature of 150°C. The value in any given application depends on the user's specific board design, and the maximum temperature of 175°C may be used if the PCB allows it.

B: The power dissipation P_D is based on T_{J(MAX)}=175°C, using junction-to-case thermal resistance, and is more useful in setting the upper dissipation limit for cases where additional heatsinking is used.

C: Repetitive rating, pulse width limited by junction temperature T_{J(MAX)}=175°C.

D: The R_{θJA} is the sum of the thermal impedance from junction to case R_{θJC} and case to ambient.

E: The static characteristics in Figures 1 to 6 are obtained using <300 μs pulses, duty cycle 0.5% max.

F: These curves are based on the junction-to-case thermal impedance which is measured with the device mounted to a large heatsink, assuming a maximum junction temperature of T_{J(MAX)}=175°C.

G: The maximum current rating is limited by bond-wires.

H: These tests are performed with the device mounted on 1 in 2 FR-4 board with 2oz. Copper, in a still air environment with T_A=25°C. The SOA curve provides a single pulse rating.

Rev1 : April 2009

THIS PRODUCT HAS BEEN DESIGNED AND QUALIFIED FOR THE CONSUMER MARKET. APPLICATIONS OR USES AS CRITICAL COMPONENTS IN LIFE SUPPORT DEVICES OR SYSTEMS ARE NOT AUTHORIZED. AOS DOES NOT ASSUME ANY LIABILITY ARISING OUT OF SUCH APPLICATIONS OR USES OF ITS PRODUCTS. AOS RESERVES THE RIGHT TO IMPROVE PRODUCT DESIGN, FUNCTIONS AND RELIABILITY WITHOUT NOTICE.

TYPICAL ELECTRICAL AND THERMAL CHARACTERISTICS

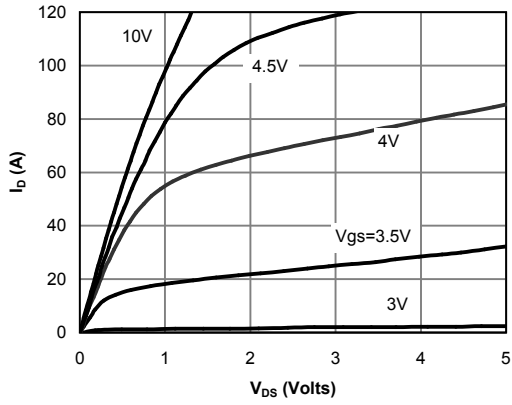

Figure 1: On-Region Characteristics

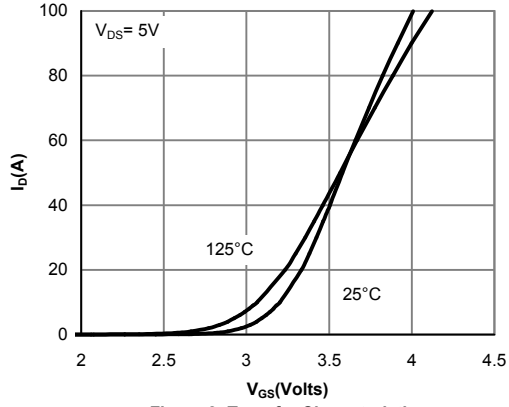

Figure 2: Transfer Characteristics

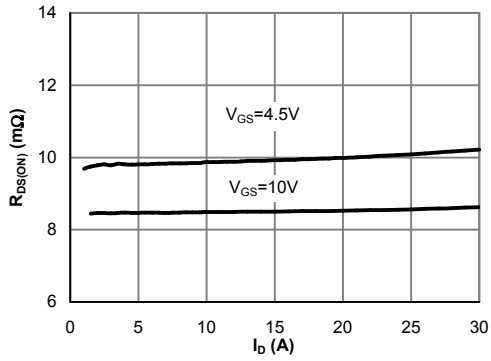

Figure 3: On-Resistance vs. Drain Current and Gate Voltage

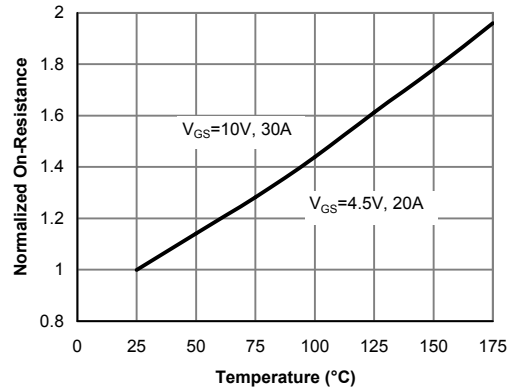

Figure 4: On-Resistance vs. Junction Temperature

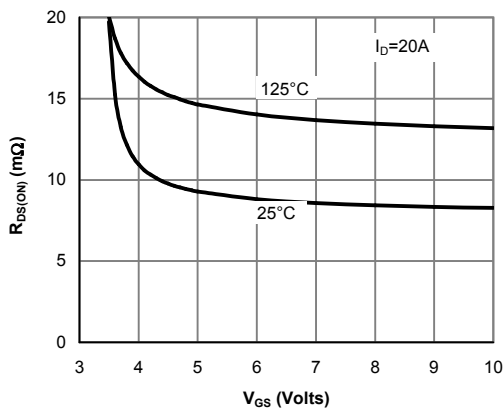

Figure 5: On-Resistance vs. Gate-Source Voltage

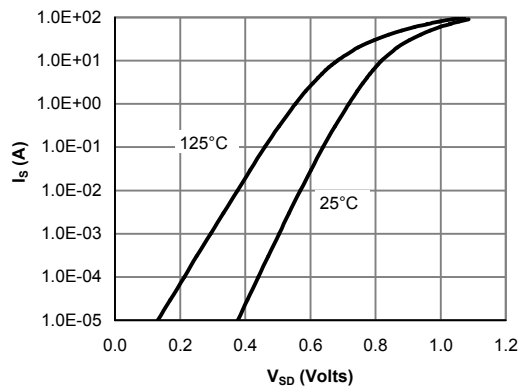

Figure 6: Body-Diode Characteristics

TYPICAL ELECTRICAL AND THERMAL CHARACTERISTICS

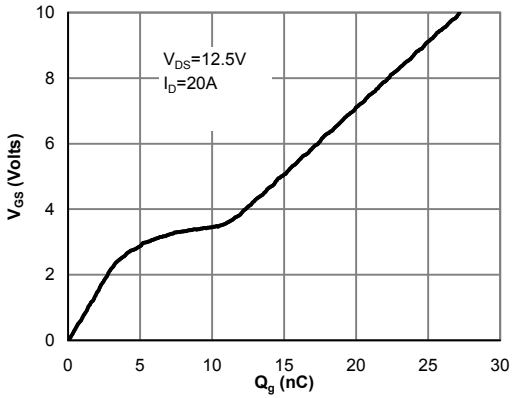

Figure 7: Gate-Charge Characteristics

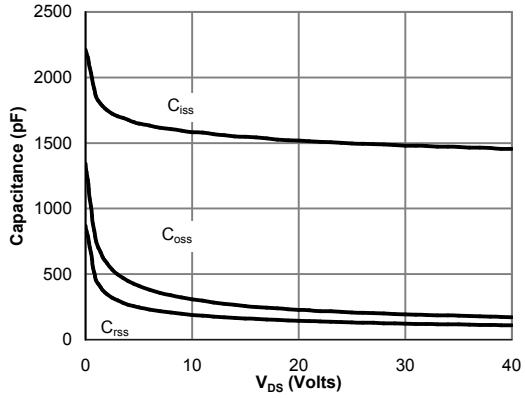

Figure 8: Capacitance Characteristics

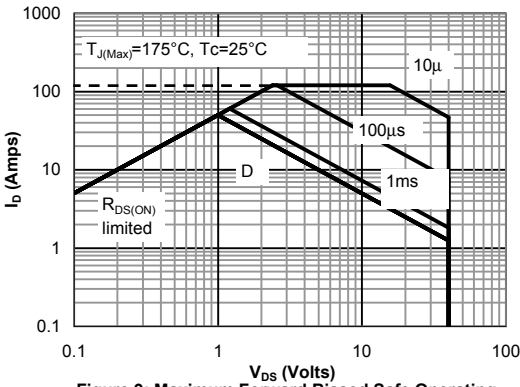

Figure 9: Maximum Forward Biased Safe Operating Area (Note F)

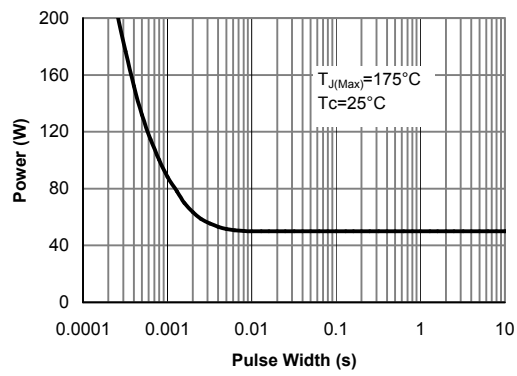

Figure 10: Single Pulse Power Rating Junction-to-Case (Note F)

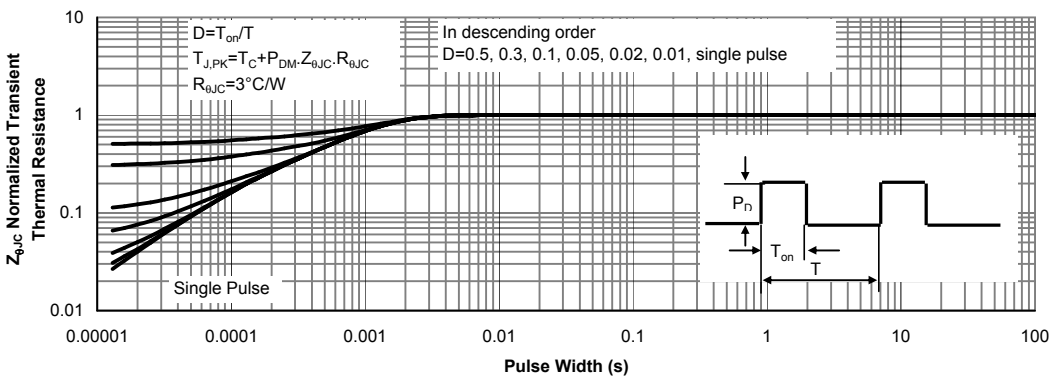

Figure 11: Normalized Maximum Transient Thermal Impedance (Note F)

TYPICAL ELECTRICAL AND THERMAL CHARACTERISTICS

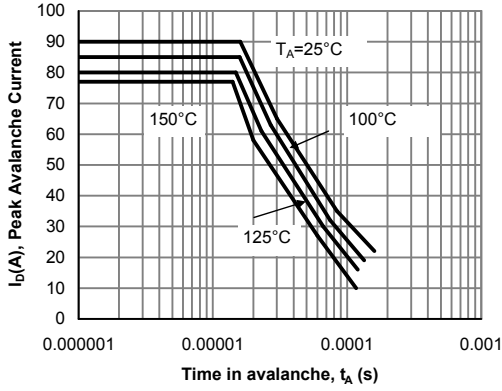

Figure 12: Single Pulse Avalanche capability

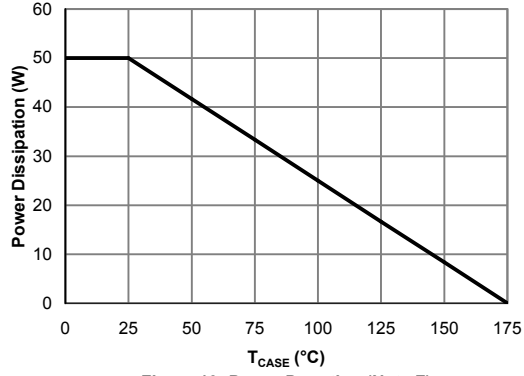

Figure 13: Power De-rating (Note F)

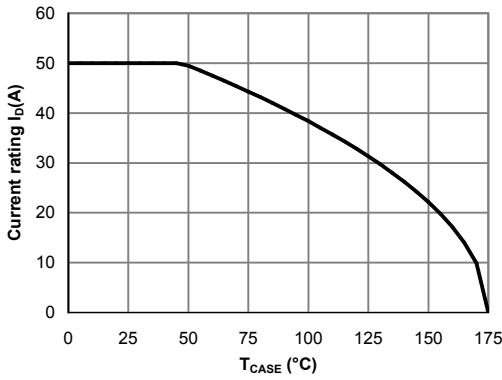

Figure 14: Current De-rating (Note F)

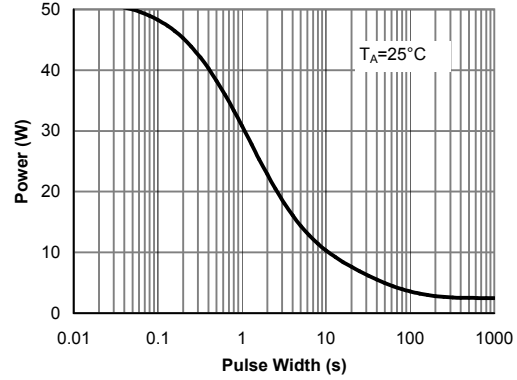

Figure 15: Single Pulse Power Rating Junction-to-Ambient (Note H)

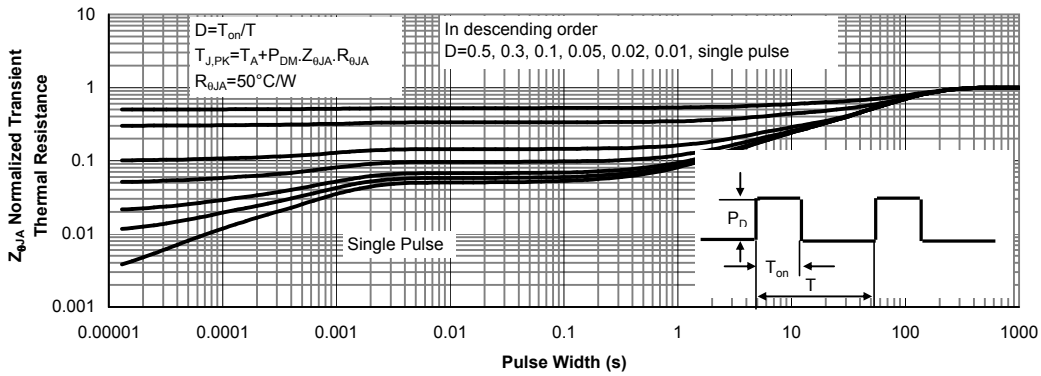
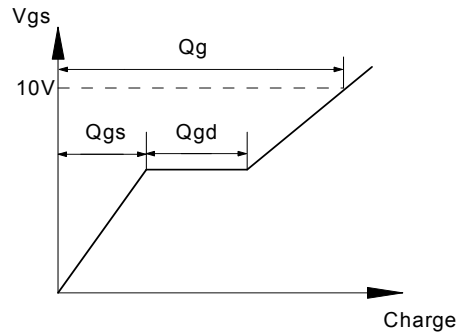
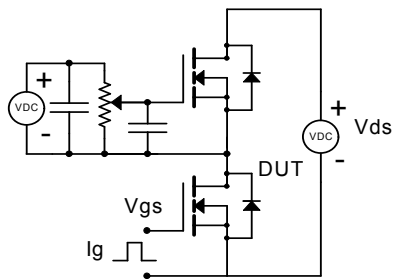
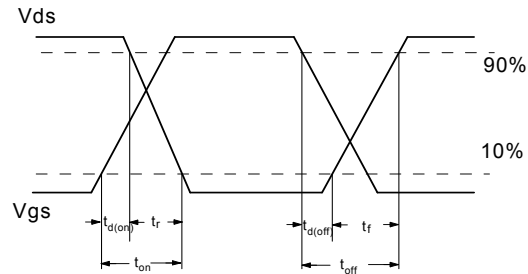
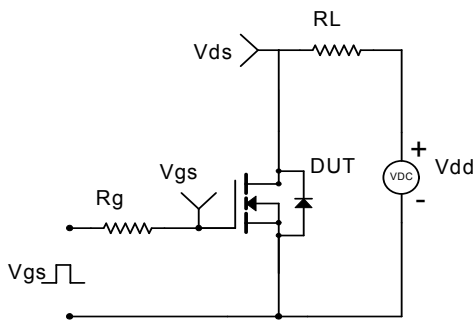

Figure 16: Normalized Maximum Transient Thermal Impedance (Note H)

Gate Charge Test Circuit & Waveform



Resistive Switching Test Circuit & Waveforms



Unclamped Inductive Switching (UIS) Test Circuit & Waveforms

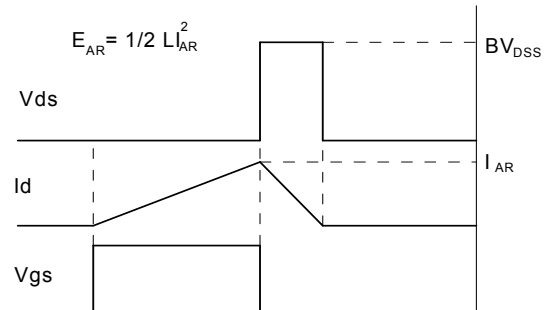
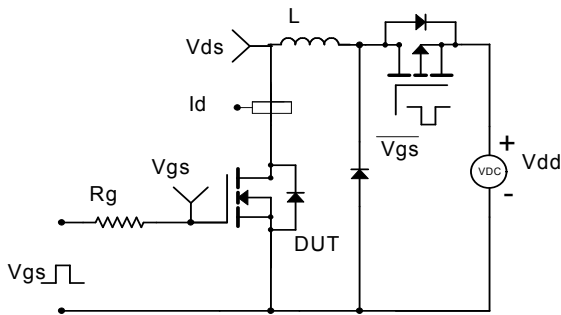

Diode Recovery Test Circuit & Waveforms

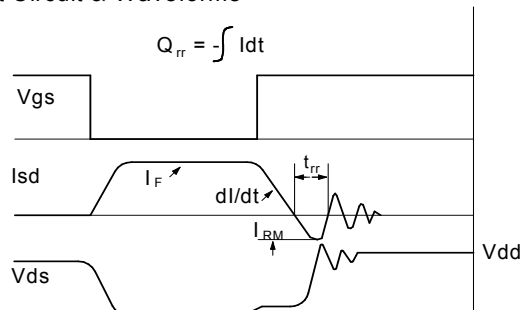
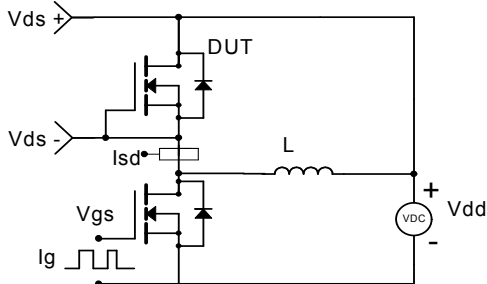

Looking for pricing, stock, or lifecycle information?

Click below to explore more details on WIN SOURCE:

- [View AOB4184 on WIN SOURCE](#)
- [Alpha & Omega Semiconductor Inc. Information](#)

Optimize Your Supply Chain with WIN SOURCE Solutions

- ✓ Global Sourcing Solution
- ✓ Obsolete Management
- ✓ Cost Control Management
- ✓ Shortage Management
- ✓ Alternative Solution
- ✓ Excess Inventory Management