



**THE DATASHEET OF
BA10324AFV**



Quad ground sense operational amplifier

BA10324A / BA10324AF / BA10324AFV

The BA10324A, BA10324AF, and BA10324AFV are monolithic ICs with four built-in operational amplifiers featuring internal phase compensation.

Either a dual or single power supply can be driven, and these products can be driven by a digital system 5V single power supply. These products can be used in a wide range of administrative and industrial applications, including transducer amplifiers and DC amplifiers.

●Applications

Ground sensing type pre-amplifiers

Active filters

DC amplifiers

Pulse generators.

●Features

- 1) Wide range of operating power supply voltages and single power supply drive enabled.
(single power supply: 3 to 32V, dual power supply: ± 1.5 to ± 16 V)
- 2) Common-mode input voltage can be operated from the ground level.
- 3) Differential input voltage can be operated up to the power supply voltage level.
- 4) Low current dissipation. ($I_Q = 0.6\text{mA}$)
- 5) Low offset voltage and offset current. ($V_{IO} = 2\text{mV}$, $I_{IO} = 5\text{nA typ.}$)
- 6) Four operational amplifiers with phase compensation are built into the DIP / SOP Pin 14.
- 7) Compatible with model 324 operational amplifiers of other manufacturers.

●Block diagram

BA10324A / BA10324AF / BA10324AFV

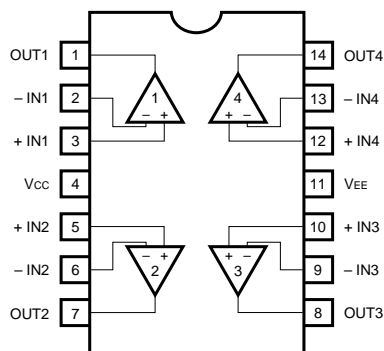

●Internal circuit configuration

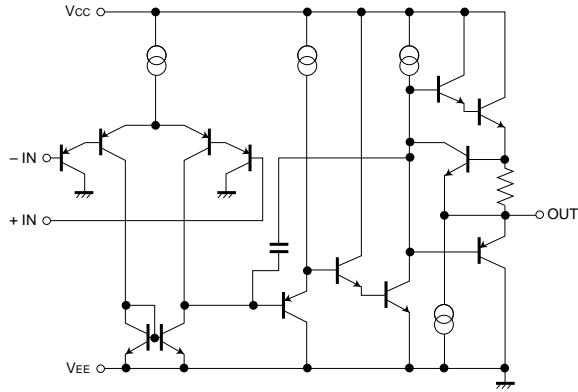

●Absolute maximum ratings (Ta = 25°C)

Parameter	Symbol	Limits			Unit
		BA10324A	BA10324AF	BA10324AFV	
Power supply voltage	V _{CC}	32 (± 16)	32 (± 16)	32 (± 16)	V
Power dissipation	P _d	950*	450*	400*	mW
Differential input voltage	V _{ID}	± V _{CC}	± V _{CC}	± V _{CC}	V
Common-mode input voltage	V _I	- 0.3 ~ V _{CC}	- 0.3 ~ V _{CC}	- 0.3 ~ V _{CC}	V
Operating temperature	T _{opr}	- 40 ~ + 85	- 40 ~ + 85	- 40 ~ + 85	°C
Storage temperature	T _{stg}	- 55 ~ + 125	- 55 ~ + 125	- 55 ~ + 125	°C

* Refer to the P_d characteristics diagram.

The values for the are those when BA10324AF / BA10324AFV it is mounted on a glass epoxy board (50mm × 50mm × 1.6mm).

●Electrical characteristics (unless otherwise noted, Ta = 25°C, Vcc = 5V)

Parameter		Symbol	Min.	Typ.	Max.	Unit	Conditions
Input offset voltage		V_{io}	—	2	7	mV	$R_s = 50\Omega$
Input offset current		I_{io}	—	5	50	nA	
Input bias current		I_b	—	20	250	nA	*1
Common-mode input voltage		V_{ICM}	0	—	$V_{CC} - 1.5$	V	
Common-mode rejection ratio		CMRR	65	75	—	dB	
High-amplitude voltage gain		A_{Vol}	87	100	—	dB	$R_L \cong 2k\Omega, V_{CC} = 15V$
Power supply voltage rejection ratio		PSRR	65	100	—	dB	$R_s = 50\Omega$
Quiescent current		I_q	—	0.6	2.0	mA	$R_L = \infty$, on All Op - Amps
Maximum output voltage		V_{OH}	$V_{CC} - 1.5$	—	—	V	$R_L = 2k\Omega$
		V_{OL}	—	—	0.25	V	$R_L = \infty$
Maximum output current	Source	I_{OH}	20	35	—	mA	$V_o = 0$
	Sink	I_{OL}	10	20	—	mA	$V_o = V_{CC}$
Channel separation		CS	—	120	—	dB	$f = 1kHz$ input conversion

*1 Because the first stage is configured with a PNP transistor, input bias current is from the IC.

●Electrical characteristic curves

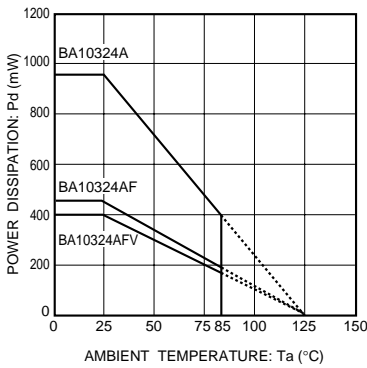

Fig.1 Power dissipation vs. ambient temperature

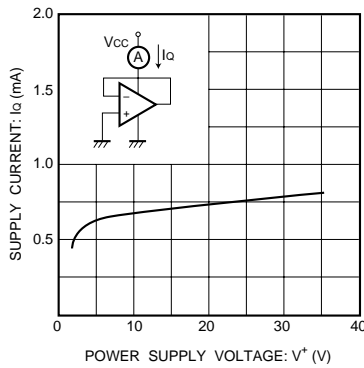

Fig.2 Quiescent current vs. power supply voltage

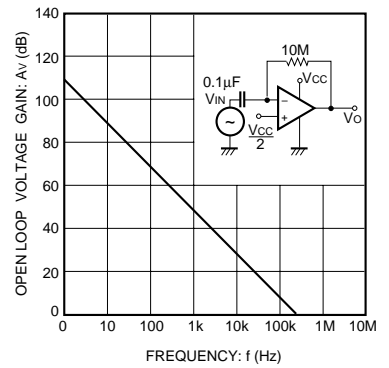

Fig.3 Open loop voltage gain vs. frequency

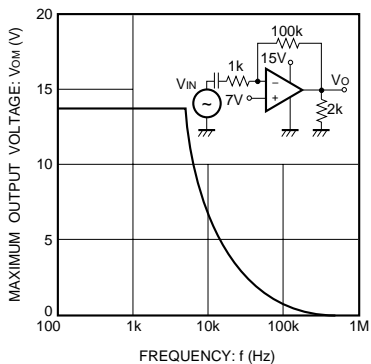

Fig.4 Maximum output voltage vs. frequency

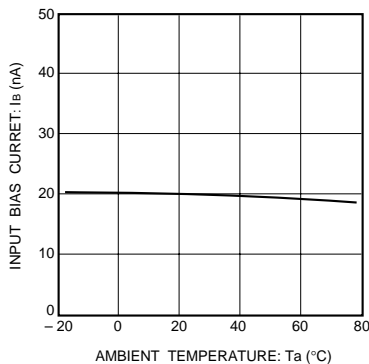

Fig.5 Input bias current vs. ambient temperature

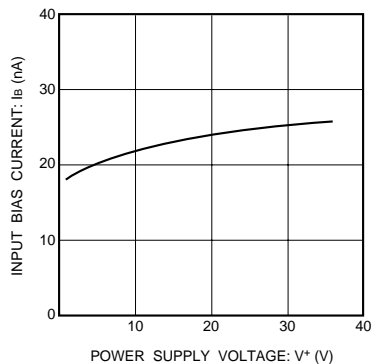

Fig.6 Input bias current vs. power supply voltage

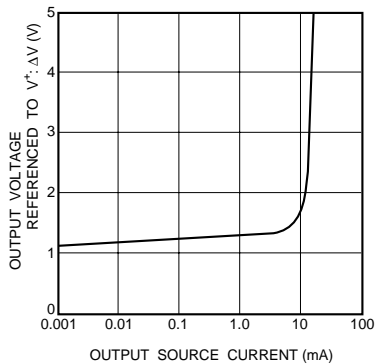

Fig.7 Potential difference during power supply output vs. output source current

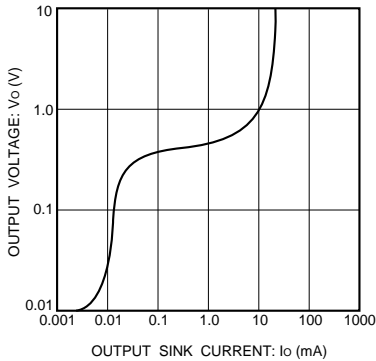

Fig.8 Output voltage vs. output sink current

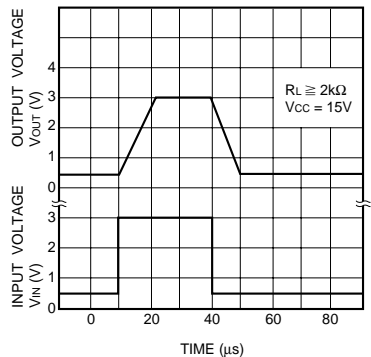

Fig.9 Output response characteristics

●Operation notes

(1) Unused circuit connections

If there are any circuits which are not being used, we recommend making connections as shown in Figure 10, with the non-inverted input pin connected to the potential within the in-phase input voltage range (V_{ICM}).

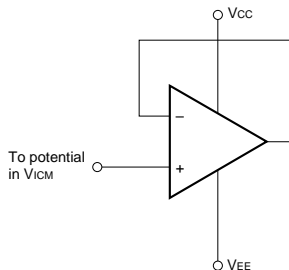
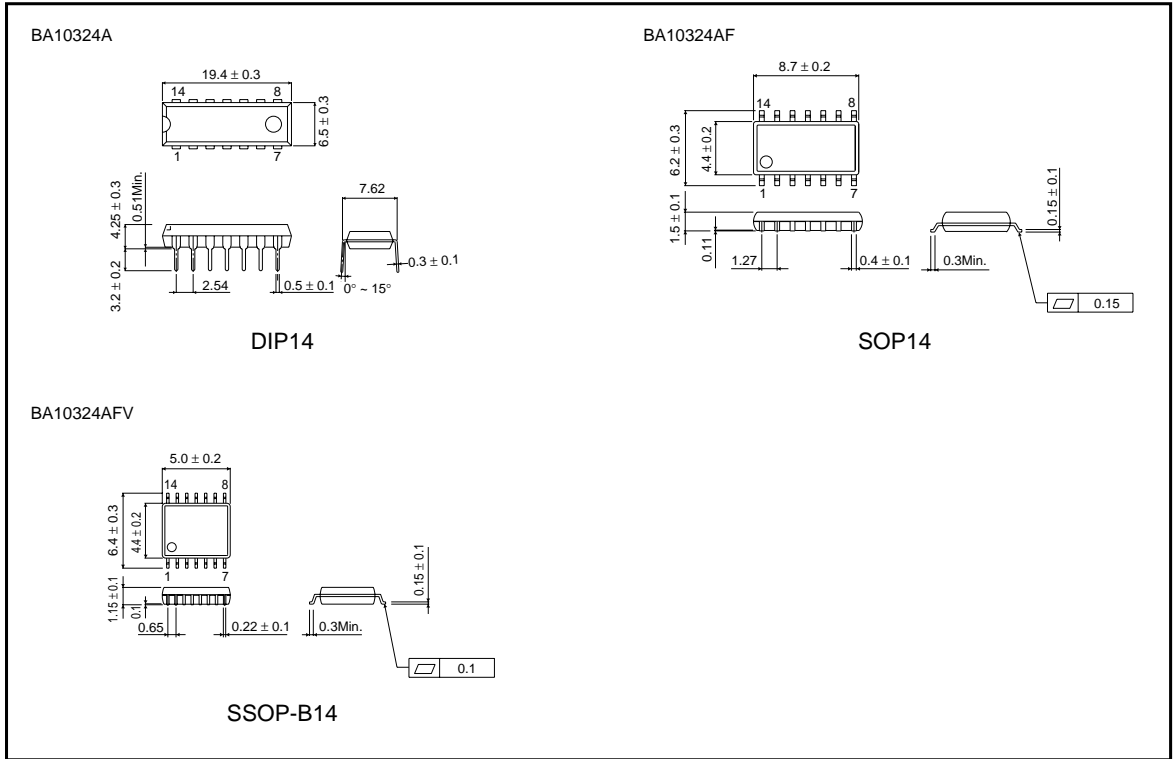

Fig.10 Unused circuit connections

●External dimensions (Units: mm)



Notes

- No technical content pages of this document may be reproduced in any form or transmitted by any means without prior permission of ROHM CO.,LTD.
- The contents described herein are subject to change without notice. The specifications for the product described in this document are for reference only. Upon actual use, therefore, please request that specifications to be separately delivered.
- Application circuit diagrams and circuit constants contained herein are shown as examples of standard use and operation. Please pay careful attention to the peripheral conditions when designing circuits and deciding upon circuit constants in the set.
- Any data, including, but not limited to application circuit diagrams information, described herein are intended only as illustrations of such devices and not as the specifications for such devices. ROHM CO.,LTD. disclaims any warranty that any use of such devices shall be free from infringement of any third party's intellectual property rights or other proprietary rights, and further, assumes no liability of whatsoever nature in the event of any such infringement, or arising from or connected with or related to the use of such devices.
- Upon the sale of any such devices, other than for buyer's right to use such devices itself, resell or otherwise dispose of the same, no express or implied right or license to practice or commercially exploit any intellectual property rights or other proprietary rights owned or controlled by
- ROHM CO., LTD. is granted to any such buyer.
- Products listed in this document use silicon as a basic material.
Products listed in this document are no antiradiation design.

The products listed in this document are designed to be used with ordinary electronic equipment or devices (such as audio visual equipment, office-automation equipment, communications devices, electrical appliances and electronic toys).

Should you intend to use these products with equipment or devices which require an extremely high level of reliability and the malfunction of which would directly endanger human life (such as medical instruments, transportation equipment, aerospace machinery, nuclear-reactor controllers, fuel controllers and other safety devices), please be sure to consult with our sales representative in advance.



About Export Control Order in Japan

Products described herein are the objects of controlled goods in Annex 1 (Item 16) of Export Trade Control Order in Japan.

In case of export from Japan, please confirm if it applies to "objective" criteria or an "informed" (by MITI clause) on the basis of "catch all controls for Non-Proliferation of Weapons of Mass Destruction.

Looking for pricing, stock, or lifecycle information?

Click below to explore more details on WIN SOURCE:

-  [View BA10324AFV on WIN SOURCE](#)
-  [Rohm Semiconductor Information](#)

Optimize Your Supply Chain with WIN SOURCE Solutions

-  Global Sourcing Solution
-  Obsolete Management
-  Cost Control Management
-  Shortage Management
-  Alternative Solution
-  Excess Inventory Management