



**THE DATASHEET OF
ADV7340BSTZ**



FEATURES**74.25 MHz 20-/30-bit high definition input support**

Compliant with SMPTE 274 M (1080i), 296 M (720p),
and 240 M (1035i)

6 Noise Shaped Video® (NSV) 12-bit video DACs

16× (216 MHz) DAC oversampling for SD

8× (216 MHz) DAC oversampling for ED

4× (297 MHz) DAC oversampling for HD

37 mA maximum DAC output current

NTSC M, PAL B/D/G/H/I/M/N, PAL 60 support**NTSC and PAL square pixel operation (24.54 MHz/29.5 MHz)****Multiformat video input support**

4:2:2 YCrCb (SD, ED, and HD)

4:4:4 YCrCb (ED and HD)

4:4:4 RGB (SD, ED, and HD)

Multiformat video output support

Composite (CVBS) and S-Video (Y-C)

Component YPrPb (SD, ED, and HD)

Component RGB (SD, ED, and HD)

Macrovision Rev 7.1.L1 (SD) and Rev 1.2 (ED) compliant**Simultaneous SD and ED/HD operation****EIA/CEA-861B compliance support****Copy generation management system (CGMS)****Closed captioning and wide screen signaling (WSS)****Integrated subcarrier locking to external video source****Complete on-chip video timing generator****On-chip test pattern generation****On-board voltage reference (optional external input)****Programmable features**

Luma and chroma filter responses

Vertical blanking interval (VBI)

Subcarrier frequency (F_{sc}) and phase

Luma delay

High definition (HD) programmable features

(720p/1080i/1035i)

4× oversampling (297 MHz)

Internal test pattern generator

Fully programmable YCrCb to RGB matrix

Gamma correction

Programmable adaptive filter control

Programmable sharpness filter control

CGMS (720p/1080i) and CGMS Type B (720p/1080i)

Undershoot limiter

Dual data rate (DDR) input support

Enhanced definition (ED) programmable features

(525p/625p)

8× oversampling (216 MHz output)

Internal test pattern generator

Black bar, hatch, flat field/frame

Individual Y and PrPb output delay

Gamma correction

Programmable adaptive filter control

Fully programmable YCrCb to RGB matrix

Undershoot limiter

Macrovision Rev 1.2 (525p/625p) (ADV7340 only)

CGMS (525p/625p) and CGMS Type B (525p)

Dual data rate (DDR) input support

Standard definition (SD) programmable features

16× oversampling (216 MHz)

Internal test pattern generator

Color and black bar

Controlled edge rates for start and end of active video

Individual Y and PrPb output delay

Undershoot limiter

Gamma correction

Digital noise reduction (DNR)

Multiple chroma and luma filters

Luma-SSAF filter with programmable gain/attenuation

PrPb SSAF

Separate pedestal control on component and
composite/S-Video output

VCR FF/RW sync mode

Macrovision Rev 7.1.L1 (ADV7340 only)

Copy generation management system (CGMS)

Wide screen signaling (WSS)

Closed captioning

Serial MPU interface with I²C compatibility

3.3 V analog operation

1.8 V digital operation

1.8 V or 3.3 V I/O operation

Temperature range: -40°C to +85°C

APPLICATIONS

DVD recorders and players

High definition Blu-ray DVD players

Rev. C

Information furnished by Analog Devices is believed to be accurate and reliable. However, no responsibility is assumed by Analog Devices for its use, nor for any infringements of patents or other rights of third parties that may result from its use. Specifications subject to change without notice. No license is granted by implication or otherwise under any patent or patent rights of Analog Devices. Trademarks and registered trademarks are the property of their respective owners.

TABLE OF CONTENTS

Features	1	SD Subcarrier Frequency Lock.....	55
Applications.....	1	SD VCR FF/RW Sync	55
Revision History	4	Vertical Blanking Interval	55
General Description	5	SD Subcarrier Frequency Control.....	56
Functional Block Diagram	6	SD Noninterlaced Mode.....	56
Specifications.....	7	SD Square Pixel Mode	56
Power Supply and Voltage Specifications.....	7	Filters.....	57
Voltage Reference Specifications	7	ED/HD Test Pattern Color Controls	58
Input Clock Specifications	7	Color Space Conversion Matrix	59
Analog Output Specifications	8	SD Luma and Color Scale Control.....	60
Digital Input/Output Specifications—3.3 V	8	SD Hue Adjust Control.....	60
Digital Input/Output Specifications—1.8 V	8	SD Brightness Detect	61
Digital Timing Specifications—3.3 V	9	SD Brightness Control	61
Digital Timing Specifications—1.8 V	10	SD Input Standard Autodetection.....	61
MPU Port Timing Specifications	11	Double Buffering.....	62
Power Specifications	11	Programmable DAC Gain Control	62
Video Performance Specifications	12	Gamma Correction	62
Timing Diagrams.....	13	ED/HD Sharpness Filter and Adaptive Filter Controls.....	64
Absolute Maximum Ratings.....	21	ED/HD Sharpness Filter and Adaptive Filter Application Examples.....	65
Thermal Resistance	21	SD Digital Noise Reduction	66
ESD Caution.....	21	SD Active Video Edge Control	67
Pin Configuration and Function Descriptions.....	22	External Horizontal and Vertical Synchronization Control.	69
Typical Performance Characteristics	24	Low Power Mode.....	70
MPU Port Description	29	Cable Detection	70
I ² C Operation.....	29	DAC Autopower-Down.....	70
Register Map Access.....	31	Sleep Mode.....	71
Register Programming.....	31	Pixel and Control Port Readback.....	71
Subaddress Register (SR7 to SR0)	31	Reset Mechanism.....	71
Input Configuration	49	SD Teletext Insertion	71
Standard Definition Only.....	49	Printed Circuit Board Layout and Design	73
Enhanced Definition/High Definition Only	51	Unused Pins	73
Simultaneous Standard Definition and Enhanced Definition/High Definition.....	51	DAC Configurations	73
Enhanced Definition Only (at 54 MHz)	52	Voltage Reference	73
Output Configuration	53	Video Output Buffer and Optional Output Filter.....	73
Design Features.....	54	Printed Circuit Board (PCB) Layout	74
Output Oversampling.....	54	Typical Application Circuit.....	76
HD Interlace External $\overline{P_HSYNC}$ and $\overline{P_VSYNC}$ Considerations	54	Copy Generation Management System.....	77
ED/HD Timing Reset	55	SD CGMS	77
		ED CGMS.....	77

HD CGMS.....	77	ED/HD YPrPb Output Levels	91
CGMS CRC Functionality	77	SD/ED/HD RGB Output Levels.....	92
SD Wide Screen Signaling.....	80	SD Output Plots	93
SD Closed Captioning	81	Video Standards	94
Internal Test Pattern Generation.....	82	Configuration Scripts	96
SD Test Patterns.....	82	Standard Definition	96
ED/HD Test Patterns	82	Enhanced Definition	100
SD Timing	83	High Definition	104
HD Timing.....	89	Outline Dimensions.....	108
Video Output Levels	90	Ordering Guide	108
SD YPrPb Output Levels—SMPTE/EBU N10	90		

REVISION HISTORY

3/12—Rev. B to Rev. C

Change to Features Section 1
 Deleted Endnote 1 from Table 1 5
 Added Conditions to Digital Input/Output Specifications—1.8 V Section 8
 Changes to Pin 48 Description, Table 15 22
 Changes to Table 21 35
 Added Register 0x3A to Table 24 38
 Changes to Table 29 42
 Changes to Subaddress 0x87, Bit 7 = 1 Section 49
 Deleted ED/HD Nontandard Timing Mode Section, Figure 59, Figure 60, Figure 61, and Table 42 53
 Added External Sync Polarity Section 54
 Deleted Subcarrier Phase Reset (SCR) Mode and Timing Reset (TR) Mode Sections 54
 Renamed SD Subcarrier Frequency Lock, Subcarrier Phase Reset, and Timing Reset Section to SD Subcarrier Frequency Lock Section 55
 Changes to ED/HD Test Patterns Section 82

9/11—Rev. A to Rev. B

Changes to MPU Port Description Section 28

3/09—Rev. 0 to Rev. A

Changes to Features Section 1
 Deleted Detailed Features Section, Changes to Table 1 4
 Changes to Figure 1 5
 Changes to Table 6 7
 Added Digital Input/Output Specifications—1.8 V Section and Table 7 7
 Changes to Digital Timing Specifications—3.3 V Section and Table 8 8
 Added Table 9 9
 Changes to MPU Port Timing Specifications Section, Default Conditions 10
 Deleted Figure 20 19
 Changes to Table 13 20
 Changes to Table 15 21
 Changes to MPU Port Description Section 28
 Changes to I²C Operation Section 28
 Added Table 16 28

Added Figure 49 29
 Changes to Table 17 30
 Changes to Table 18 30
 Changes to Table 21, 0x30 Bit Description 34
 Added Table 23 36
 Changes to Table 29 41
 Changes to Table 30 42
 Changes to Table 31, 0xA0 Register Name 44
 Changes to Table 32 46
 Added Table 33 46
 Added Table 34 47
 Changes to Standard Definition Only Section 48
 Changes to Figure 57 51
 Renamed Features Section to Design Features Section 53
 Changes to ED/HD Nonstandard Timing Mode Section 53
 Added HD Interlace External P_HSYNC and P_VSYNC Considerations Section 54
 Changes to SD Subcarrier Frequency Lock, Subcarrier Phase Reset, and Timing Reset Section 54
 Changes to Subaddress 0x8C to Subaddress 0x8F Section 56
 Changes to Programming the F_{sc} Section 56
 Changes to Subaddress 0x82, Bit 4 Section 56
 Added SD Manual CSC Matrix Adjust Feature Section 59
 Changes to Subaddress 0x9C to Subaddress 0x9F Section 60
 Changes to SD Brightness Detect Section 61
 Changes to Figure 71 63
 Added Sleep Mode Section 71
 Changes to Pixel and Control Port Readback Section 71
 Changes to Reset Mechanism Section 71
 Added SD Teletext Insertion Section 71
 Added Figure 86 and Figure 87 73
 Added Unused Pins Section 73
 Changes to Power Supply Sequencing Section 75
 Changes to Figure 94 78
 Changes to SD Wide Screen Signaling Section 80
 Changes to Internal Test Pattern Generation Section 82
 Changes to SD Timing, Mode 0 (CCIR-656)—Slave Option (Subaddress 0x8A = XXXXX000) Section 83
 Added Configuration Scripts Section 96

10/06—Revision 0: Initial Version

GENERAL DESCRIPTION

The ADV7340/ADV7341 are high speed, digital-to-analog video encoders in a 64-lead LQFP package. Six high speed, NSV, 3.3 V, 12-bit video DACs provide support for composite (CVBS), S-Video (Y-C), and component (YPrPb/RGB) analog outputs in standard definition (SD), enhanced definition (ED), or high definition (HD) video formats.

The ADV7340/ADV7341 have a 30-bit pixel input port that can be configured in a variety of ways. SD video formats are supported over an SDR interface, and ED/HD video formats are supported over SDR and DDR interfaces. Pixel data can be supplied in either the YCrCb or RGB color space.

The parts also support embedded EAV/SAV timing codes, external video synchronization signals, and I²C[®] communication protocol.

In addition, simultaneous SD and ED/HD input and output are supported. Full-drive DACs ensure that external output buffering is not required, while 216 MHz (SD and ED) and 297 MHz (HD) oversampling ensures that external output filtering is not required.

Cable detection and DAC autopower-down features keep power consumption to a minimum.

Table 1 lists the video standards directly supported by the ADV7340/ADV7341.

Table 1. Standards Directly Supported by the ADV7340/ADV7341

Active Resolution	I/P ¹	Frame Rate (Hz)	Clock Input (MHz)	Standard
720 × 240	P	59.94	27	
720 × 288	P	50	27	
720 × 480	I	29.97	27	ITU-R BT.601/656
720 × 576	I	25	27	ITU-R BT.601/656
640 × 480	I	29.97	24.54	NTSC Square Pixel
768 × 576	I	25	29.5	PAL Square Pixel
720 × 483	P	59.94	27	SMPTE 293M
720 × 483	P	59.94	27	BTA T-1004
720 × 483	P	59.94	27	ITU-R BT.1358
720 × 576	P	50	27	ITU-R BT.1358
720 × 483	P	59.94	27	ITU-R BT.1362
720 × 576	P	50	27	ITU-R BT.1362
1920 × 1035	I	30	74.25	SMPTE 240M
1920 × 1035	I	29.97	74.1758	SMPTE 240M
1280 × 720	P	60, 50, 30, 25, 24	74.25	SMPTE 296M
1280 × 720	P	23.97, 59.94, 29.97	74.1758	SMPTE 296M
1920 × 1080	I	30, 25	74.25	SMPTE 274M
1920 × 1080	I	29.97	74.1758	SMPTE 274M
1920 × 1080	P	30, 25, 24	74.25	SMPTE 274M
1920 × 1080	P	23.98, 29.97	74.1758	SMPTE 274M
1920 × 1080	P	24	74.25	ITU-R BT.709-5

¹ I = interlaced, P = progressive.

FUNCTIONAL BLOCK DIAGRAM

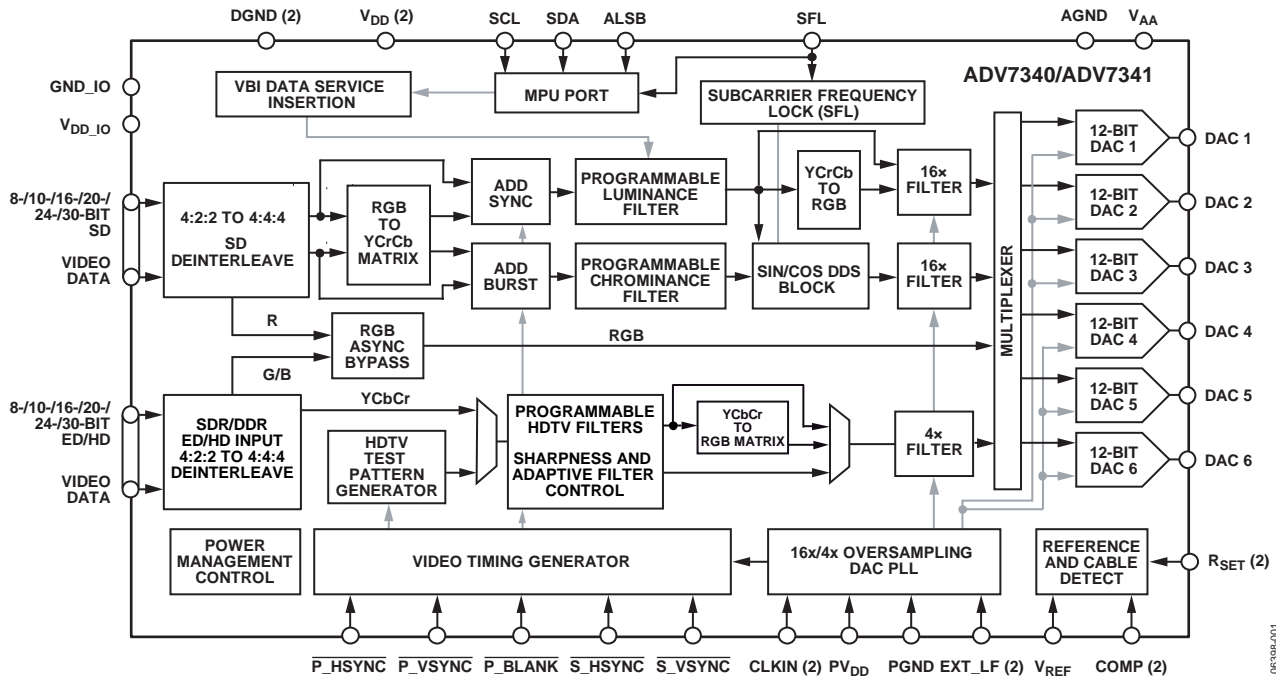

Figure 1.

06398-001

SPECIFICATIONS

POWER SUPPLY AND VOLTAGE SPECIFICATIONS

All specifications T_{MIN} to T_{MAX} (-40°C to $+85^{\circ}\text{C}$), unless otherwise noted.

Table 2.

Parameter	Min	Typ	Max	Unit
SUPPLY VOLTAGES				
V_{DD}	1.71	1.8	1.89	V
V_{DD_IO}	1.71	3.3	3.63	V
PV_{DD}	1.71	1.8	1.89	V
V_{AA}	2.6	3.3	3.465	V
POWER SUPPLY REJECTION RATIO		0.002		%/%

VOLTAGE REFERENCE SPECIFICATIONS

All specifications T_{MIN} to T_{MAX} (-40°C to $+85^{\circ}\text{C}$), unless otherwise noted.

Table 3.

Parameter	Min	Typ	Max	Unit
Internal Reference Range, V_{REF}	1.186	1.248	1.31	V
External Reference Range, V_{REF}	1.15	1.235	1.31	V
External V_{REF} Current ¹		± 10		μA

¹ External current required to overdrive internal V_{REF} .

INPUT CLOCK SPECIFICATIONS

$V_{DD} = 1.71\text{ V}$ to 1.89 V . $PV_{DD} = 1.71\text{ V}$ to 1.89 V . $V_{AA} = 2.6\text{ V}$ to 3.465 V . $V_{DD_IO} = 1.71\text{ V}$ to 3.63 V .

All specifications T_{MIN} to T_{MAX} (-40°C to $+85^{\circ}\text{C}$), unless otherwise noted.

Table 4.

Parameter	Conditions ¹	Min	Typ	Max	Unit
f_{CLKIN_A}	SD/ED		27		MHz
f_{CLKIN_A}	ED (at 54 MHz)		54		MHz
f_{CLKIN_A}	HD		74.25		MHz
f_{CLKIN_B}	ED		27		MHz
f_{CLKIN_B}	HD		74.25		MHz
CLKIN_A High Time, t_9		40			% of one clock cycle
CLKIN_A Low Time, t_{10}		40			% of one clock cycle
CLKIN_B High Time, t_9		40			% of one clock cycle
CLKIN_B Low Time, t_{10}		40			% of one clock cycle
CLKIN_A Peak-to-Peak Jitter Tolerance			2		$\pm\text{ns}$
CLKIN_B Peak-to-Peak Jitter Tolerance			2		$\pm\text{ns}$

¹ SD = standard definition, ED = enhanced definition (525p/625p), HD = high definition.

ANALOG OUTPUT SPECIFICATIONS

$V_{DD} = 1.71\text{ V to }1.89\text{ V}$. $PV_{DD} = 1.71\text{ V to }1.89\text{ V}$. $V_{AA} = 2.6\text{ V to }3.465\text{ V}$. $V_{DD_IO} = 1.71\text{ V to }3.63\text{ V}$. $V_{REF} = 1.235\text{ V}$ (driven externally). All specifications T_{MIN} to T_{MAX} ($-40^{\circ}\text{C to }+85^{\circ}\text{C}$), unless otherwise noted.

Table 5.

Parameter	Conditions	Min	Typ	Max	Unit
Full-Drive Output Current (Full-Scale)	$R_{SET} = 510\ \Omega$, $R_L = 37.5\ \Omega$ DAC 1, DAC 2, DAC 3 enabled ¹	33	34.6	37	mA
	$R_{SET} = 510\ \Omega$, $R_L = 37.5\ \Omega$ DAC 1 enabled only ²	33	33.5	37	mA
Low-Drive Output Current (Full-Scale) ³	$R_{SET} = 4.12\text{ k}\Omega$, $R_L = 300\ \Omega$	4.1	4.3	4.5	mA
DAC-to-DAC Matching	DAC 1 to DAC 6		1.0		%
Output Compliance, V_{OC}		0		1.4	V
Output Capacitance, C_{OUT}	DAC 1, DAC 2, DAC 3		10		pF
	DAC 4, DAC 5, DAC 6		6		pF
Analog Output Delay ⁴	DAC 1, DAC 2, DAC 3		8		ns
	DAC 4, DAC 5, DAC 6		6		ns
DAC Analog Output Skew	DAC 1, DAC 2, DAC 3		2		ns
	DAC 4, DAC 5, DAC 6		1		ns

¹ Applicable to full-drive capable DACs only, that is, DAC 1, DAC 2, DAC 3.

² The recommended method of bringing this typical value back to the ideal value is by adjusting Register 0x0B to the recommended value of 0x12.

³ Applicable to all DACs.

⁴ Output delay measured from the 50% point of the rising edge of the input clock to the 50% point of the DAC output full-scale transition.

DIGITAL INPUT/OUTPUT SPECIFICATIONS—3.3 V

$V_{DD} = 1.71\text{ V to }1.89\text{ V}$. $PV_{DD} = 1.71\text{ V to }1.89\text{ V}$. $V_{AA} = 2.6\text{ V to }3.465\text{ V}$. $V_{DD_IO} = 2.97\text{ V to }3.63\text{ V}$. All specifications T_{MIN} to T_{MAX} ($-40^{\circ}\text{C to }+85^{\circ}\text{C}$), unless otherwise noted.

Table 6.

Parameter	Conditions	Min	Typ	Max	Unit
Input High Voltage, V_{IH}		2.0			V
Input Low Voltage, V_{IL}				0.8	V
Input Leakage Current, I_{IN}	$V_{IN} = V_{DD_IO}$			± 10	μA
Input Capacitance, C_{IN}			4		pF
Output High Voltage, V_{OH}	$I_{SOURCE} = 400\ \mu\text{A}$	2.4			V
Output Low Voltage, V_{OL}	$I_{SINK} = 3.2\text{ mA}$			0.4	V
Three-State Leakage Current	$V_{IN} = 0.4\text{ V, }2.4\text{ V}$			± 1.0	μA
Three-State Output Capacitance			4		pF

DIGITAL INPUT/OUTPUT SPECIFICATIONS—1.8 V

When V_{DD_IO} is set to 1.8 V, all the digital video inputs and control inputs, such as I²C, HS, VS, should use 1.8 V levels.

$V_{DD} = 1.71\text{ V to }1.89\text{ V}$. $PV_{DD} = 1.71\text{ V to }1.89\text{ V}$. $V_{AA} = 2.6\text{ V to }3.465\text{ V}$. $V_{DD_IO} = 1.71\text{ V to }1.89\text{ V}$. All specifications T_{MIN} to T_{MAX} ($-40^{\circ}\text{C to }+85^{\circ}\text{C}$), unless otherwise noted.

Table 7.

Parameter	Conditions	Min	Typ	Max	Unit
Input High Voltage, V_{IH}		$0.7 V_{DD_IO}$			V
Input Low Voltage, V_{IL}				$0.3 V_{DD_IO}$	V
Input Capacitance, C_{IN}			4		pF
Output High Voltage, V_{OH}	$I_{SOURCE} = 400\ \mu\text{A}$	$V_{DD_IO} - 0.4$			V
Output Low Voltage, V_{OL}	$I_{SINK} = 3.2\text{ mA}$			0.4	V
Three-State Output Capacitance			4		pF

DIGITAL TIMING SPECIFICATIONS—3.3 V

$V_{DD} = 1.71\text{ V to }1.89\text{ V}$. $PV_{DD} = 1.71\text{ V to }1.89\text{ V}$. $V_{AA} = 2.6\text{ V to }3.465\text{ V}$. $V_{DD_{IO}} = 2.97\text{ V to }3.63\text{ V}$.
All specifications T_{MIN} to T_{MAX} (-40°C to $+85^{\circ}\text{C}$), unless otherwise noted.

Table 8.

Parameter	Conditions ¹	Min	Typ	Max	Unit
VIDEO DATA AND VIDEO CONTROL PORT ^{2, 3}					
Data Input Setup Time, t_{11}^4	SD	2.1			ns
	ED/HD-SDR	2.3			ns
	ED/HD-DDR	2.3			ns
	ED (at 54 MHz)	1.7			ns
Data Input Hold Time, t_{12}^4	SD	1.0			ns
	ED/HD-SDR	1.1			ns
	ED/HD-DDR	1.1			ns
	ED (at 54 MHz)	1.0			ns
Control Input Setup Time, t_{11}^4	SD	2.1			ns
	ED/HD-SDR or ED/HD-DDR	2.3			ns
	ED (at 54 MHz)	1.7			ns
Control Input Hold Time, t_{12}^4	SD	1.0			ns
	ED/HD-SDR or ED/HD-DDR	1.1			ns
	ED (at 54 MHz)	1.0			ns
Control Output Access Time, t_{13}^4	SD			12	ns
	ED/HD-SDR, ED/HD-DDR or ED (at 54 MHz)			10	ns
Control Output Hold Time, t_{14}^4	SD	4.0			ns
	ED/HD-SDR, ED/HD-DDR or ED (at 54 MHz)	3.5			ns
PIPELINE DELAY ⁵					
SD ¹					
CVBS/YC Outputs (2×)	SD oversampling disabled		68		Clock cycles
CVBS/YC Outputs (16×)	SD oversampling enabled		67		Clock cycles
Component Outputs (2×)	SD oversampling disabled		78		Clock cycles
Component Outputs (16×)	SD oversampling enabled		84		Clock cycles
ED ¹					
Component Outputs (1×)	ED oversampling disabled		41		Clock cycles
Component Outputs (8×)	ED oversampling enabled		46		Clock cycles
HD ¹					
Component Outputs (1×)	HD oversampling disabled		40		Clock cycles
Component Outputs (4×)	HD oversampling enabled		44		Clock cycles

¹ SD = standard definition, ED = enhanced definition (525p/625p), HD = high definition, SDR = single data rate, DDR = dual data rate.

² Video data: C[9:0], Y[9:0], and S[9:0].

³ Video control: P_HSYNC, P_VSYNC, P_BLANK, S_HSYNC, and S_VSYNC.

⁴ Guaranteed by characterization.

⁵ Guaranteed by design.

DIGITAL TIMING SPECIFICATIONS—1.8 V

$V_{DD} = 1.71 \text{ V to } 1.89 \text{ V}$. $PV_{DD} = 1.71 \text{ V to } 1.89 \text{ V}$. $V_{AA} = 2.6 \text{ V to } 3.465 \text{ V}$. $V_{DD,IO} = 1.71 \text{ V to } 1.89 \text{ V}$.

All specifications T_{MIN} to T_{MAX} (-40°C to $+85^{\circ}\text{C}$), unless otherwise noted.

Table 9.

Parameter	Conditions ¹	Min	Typ	Max	Unit
VIDEO DATA AND VIDEO CONTROL PORT ^{2, 3}					
Data Input Setup Time, t_{11}^4	SD	1.4			ns
	ED/HD-SDR	1.9			ns
	ED/HD-DDR	1.9			ns
	ED (at 54 MHz)	1.6			ns
Data Input Hold Time, t_{12}^4	SD	1.4			ns
	ED/HD-SDR	1.5			ns
	ED/HD-DDR	1.5			ns
	ED (at 54 MHz)	1.3			ns
Control Input Setup Time, t_{11}^4	SD	1.4			ns
	ED/HD-SDR or ED/HD-DDR	1.2			ns
	ED (at 54 MHz)	1.0			ns
Control Input Hold Time, t_{12}^4	SD	1.4			ns
	ED/HD-SDR or ED/HD-DDR	1.0			ns
	ED (at 54 MHz)	1.0			ns
Control Output Access Time, t_{13}^4	SD			13	ns
	ED/HD-SDR, ED/HD-DDR or ED (at 54 MHz)			12	ns
Control Output Hold Time, t_{14}^4	SD	4.0			ns
	ED/HD-SDR, ED/HD-DDR or ED (at 54 MHz)	5.0			ns
PIPELINE DELAY ⁵					
SD ¹					
CVBS/YC Outputs (2×)	SD oversampling disabled		68		Clock cycles
CVBS/YC Outputs (16×)	SD oversampling enabled		67		Clock cycles
Component Outputs (2×)	SD oversampling disabled		78		Clock cycles
Component Outputs (16×)	SD oversampling enabled		84		Clock cycles
ED ¹					
Component Outputs (1×)	ED oversampling disabled		41		Clock cycles
Component Outputs (8×)	ED oversampling enabled		46		Clock cycles
HD ¹					
Component Outputs (1×)	HD oversampling disabled		40		Clock cycles
Component Outputs (4×)	HD oversampling enabled		44		Clock cycles

¹ SD = standard definition, ED = enhanced definition (525p/625p), HD = high definition, SDR = single data rate, DDR = dual data rate.

² Video data: C[9:0], Y[9:0], and S[9:0].

³ Video control: P_HSYNC, P_VSYNC, P_BLANK, S_HSYNC, and S_VSYNC.

⁴ Guaranteed by characterization.

⁵ Guaranteed by design.

MPU PORT TIMING SPECIFICATIONS

$V_{DD} = 1.71\text{ V to }1.89\text{ V}$. $PV_{DD} = 1.71\text{ V to }1.89\text{ V}$. $V_{AA} = 2.6\text{ V to }3.465\text{ V}$. $V_{DD_IO} = 1.71\text{ V to }3.63\text{ V}$.
All specifications T_{MIN} to T_{MAX} (-40°C to $+85^{\circ}\text{C}$), unless otherwise noted.

Table 10.

Parameter	Conditions	Min	Typ	Max	Unit
MPU PORT, I ² C MODE ¹	See Figure 19				
SCL Frequency		0		400	kHz
SCL High Pulse Width, t_1		0.6			μs
SCL Low Pulse Width, t_2		1.3			μs
Hold Time (Start Condition), t_3		0.6			μs
Setup Time (Start Condition), t_4		0.6			μs
Data Setup Time, t_5		100			ns
SDA, SCL Rise Time, t_6				300	ns
SDA, SCL Fall Time, t_7				300	ns
Setup Time (Stop Condition), t_8		0.6			μs

¹ Guaranteed by characterization.

POWER SPECIFICATIONS

$V_{DD} = 1.8\text{ V}$, $PV_{DD} = 1.8\text{ V}$, $V_{AA} = 3.3\text{ V}$, $V_{DD_IO} = 3.3\text{ V}$, $T_A = 25^{\circ}\text{C}$.

Table 11.

Parameter	Conditions	Min	Typ	Max	Unit
NORMAL POWER MODE ^{1, 2}					
I_{DD} ³	SD only (16 \times oversampling)		90		mA
	ED only (8 \times oversampling) ⁴		65		mA
	HD only (4 \times oversampling) ⁴		91		mA
	SD (16 \times oversampling) and ED (8 \times oversampling)		95		mA
	SD (16 \times oversampling) and HD (4 \times oversampling)		122		mA
I_{DD_IO}			1		mA
I_{AA} ⁵	Three DACs enabled (ED/HD only)		124		mA
	Six DACs enabled (SD only and simultaneous modes)		140		mA
I_{PLL}	SD only, ED only, or HD only modes		5		mA
	Simultaneous modes		10		mA
SLEEP MODE					
I_{DD}			5		μA
I_{AA}			0.3		μA
I_{DD_IO}			0.2		μA
I_{PLL}			0.1		μA

¹ $R_{SET1} = 510\ \Omega$ (DAC 1, DAC 2, and DAC 3 operating in full-drive mode). $R_{SET2} = 4.12\ \text{k}\Omega$ (DAC 4, DAC 5, and DAC 6 operating in low-drive mode).

² 75% color bar test pattern applied to pixel data pins.

³ I_{DD} is the continuous current required to drive the digital core.

⁴ Applicable to both single data rate (SDR) and dual data rate (DDR) input modes.

⁵ I_{AA} is the total current required to supply all DACs.

VIDEO PERFORMANCE SPECIFICATIONS

V_{DD} = 1.8 V, PV_{DD} = 1.8 V, V_{AA} = 3.3 V, V_{DD_IO} = 3.3 V, T_A = 25°C, V_{REF} driven externally.

Table 12.

Parameter	Conditions	Min	Typ	Max	Unit
STATIC PERFORMANCE					
Resolution			12		Bits
Integral Nonlinearity	R _{SET1} = 510 Ω, R _{L1} = 37.5 Ω		0.75		LSBs
	R _{SET2} = 4.12 kΩ, R _{L2} = 300 Ω		1		LSBs
Differential Nonlinearity ¹ +ve	R _{SET1} = 510 Ω, R _{L1} = 37.5 Ω		0.25		LSBs
	R _{SET2} = 4.12 kΩ, R _{L2} = 300 Ω		0.8		LSBs
Differential Nonlinearity ¹ -ve	R _{SET1} = 510 Ω, R _{L1} = 37.5 Ω		0.43		LSBs
	R _{SET2} = 4.12 kΩ, R _{L2} = 300 Ω		0.35		LSBs
STANDARD DEFINITION (SD) MODE					
Luminance Nonlinearity			0.35		±%
Differential Gain	NTSC		0.3		%
Differential Phase	NTSC		0.4		Degrees
SNR	Luma ramp		63		dB
SNR	Flat field full bandwidth		79.5		dB
ENHANCED DEFINITION (ED) MODE					
Luma Bandwidth			12.5		MHz
Chroma Bandwidth			5.8		MHz
HIGH DEFINITION (HD) MODE					
Luma Bandwidth			30		MHz
Chroma Bandwidth			13.75		MHz

¹ Differential nonlinearity (DNL) measures the deviation of the actual DAC output voltage step from the ideal. For +ve DNL, the actual step value lies above the ideal step value. For -ve DNL, the actual step value lies below the ideal step value.

TIMING DIAGRAMS

The following abbreviations are used in Figure 2 to Figure 13:

- t_9 = clock high time
- t_{10} = clock low time
- t_{11} = data setup time
- t_{12} = data hold time

- t_{13} = control output access time
- t_{14} = control output hold time

In addition, refer to Table 36 for the ADV7340/ADV7341 input configuration.

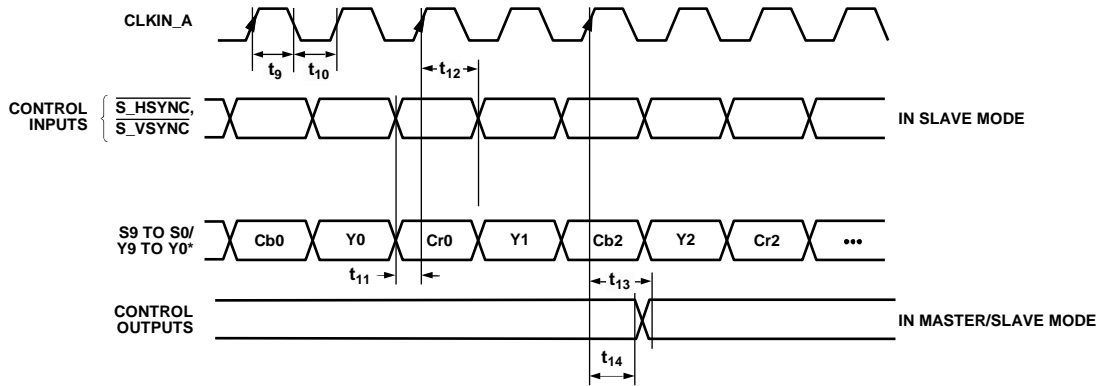

*SELECTED BY SUBADDRESS 0x01, BIT 7.

Figure 2. SD Only, 8-/10-Bit, 4:2:2 YCrCb Pixel Input Mode (Input Mode 000)

06398-002

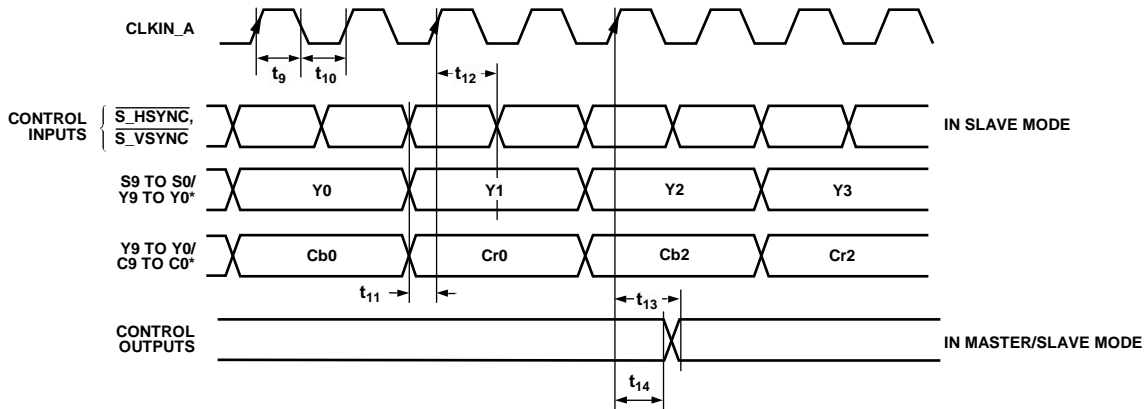

*SELECTED BY SUBADDRESS 0x01, BIT 7.

Figure 3. SD Only, 16-/20-Bit, 4:2:2 YCrCb Pixel Input Mode (Input Mode 000)

06398-003

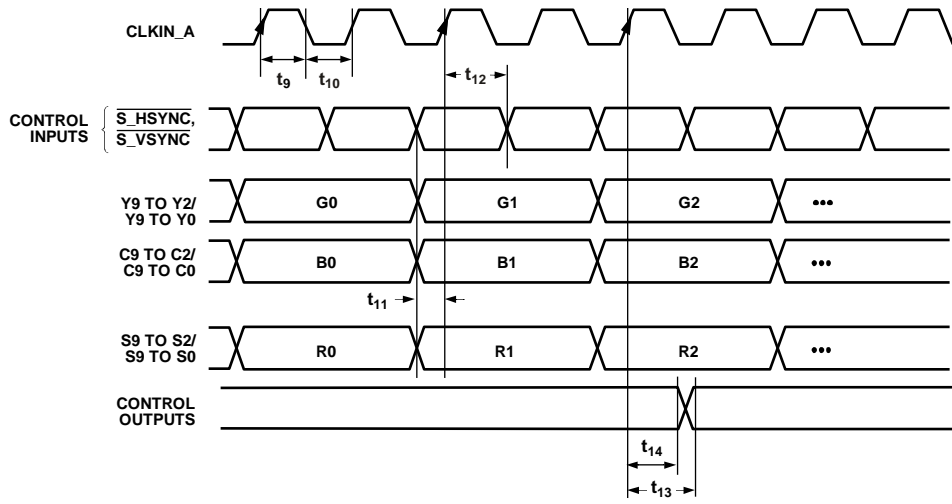

Figure 4. SD Only, 24-/30-Bit, 4:4:4 RGB Pixel Input Mode (Input Mode 000)

063388-004

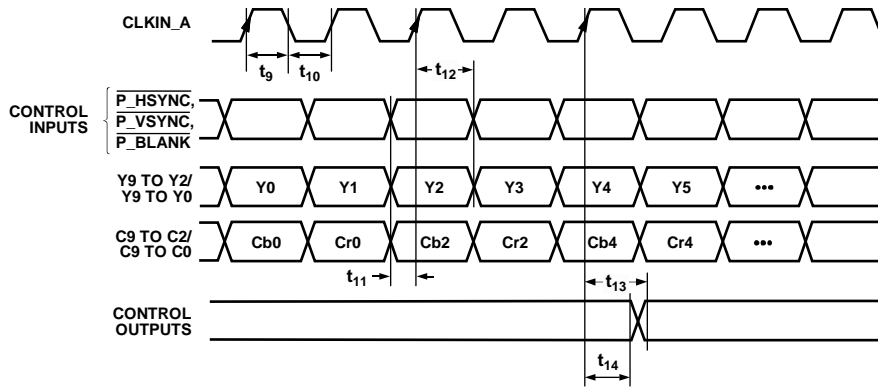

Figure 5. ED/HD-SDR Only, 16-/20-Bit, 4:2:2 YCrCb Pixel Input Mode (Input Mode 001)

063388-005

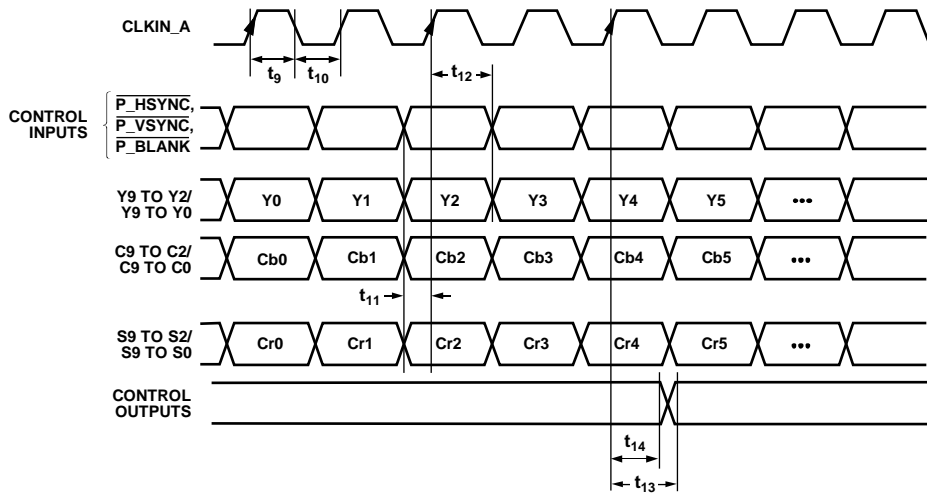

Figure 6. ED/HD-SDR Only, 24-/30-Bit, 4:4:4 YCrCb Pixel Input Mode (Input Mode 001)

063388-006

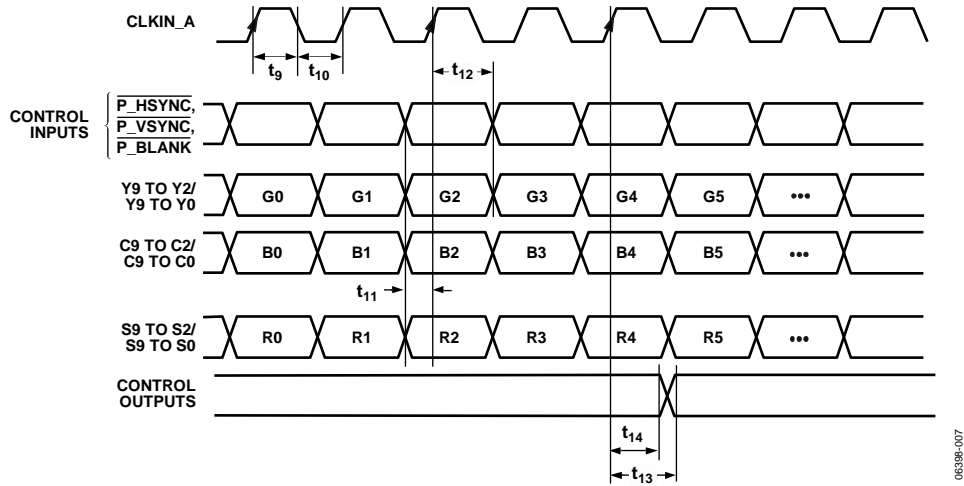
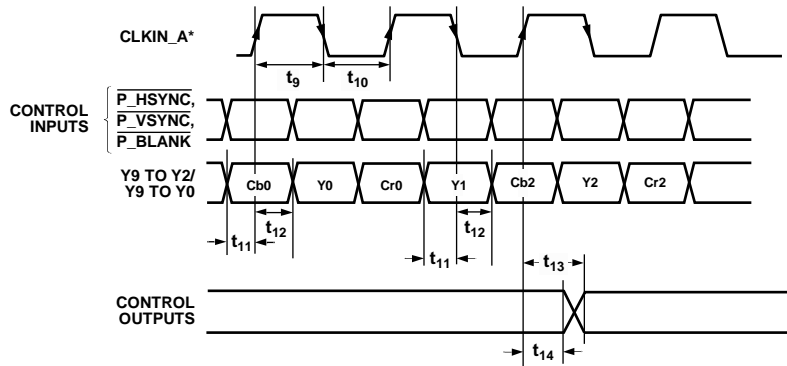
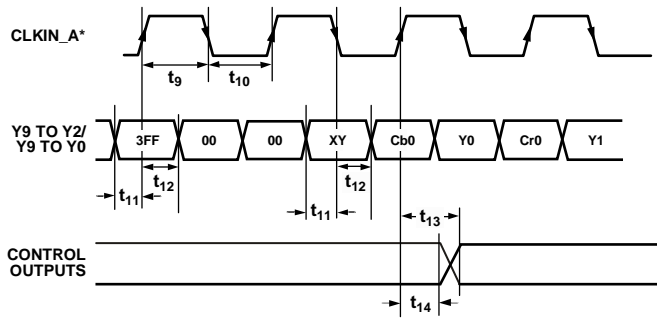

Figure 7. ED/HD-SDR Only, 24-/30-Bit, 4:4:4 RGB Pixel Input Mode (Input Mode 001)



*LUMA/CHROMA CLOCK RELATIONSHIP CAN BE INVERTED USING SUBADDRESS 0x01, BITS 1 AND 2.

Figure 8. ED/HD-DDR Only, 8-/10-Bit, 4:2:2 YCrCb (HSYNC/VSYNC) Pixel Input Mode (Input Mode 010)



*LUMA/CHROMA CLOCK RELATIONSHIP CAN BE INVERTED USING SUBADDRESS 0x01, BITS 1 AND 2.

Figure 9. ED/HD-DDR Only, 8-/10-Bit, 4:2:2 YCrCb (EAV/SAV) Pixel Input Mode (Input Mode 010)

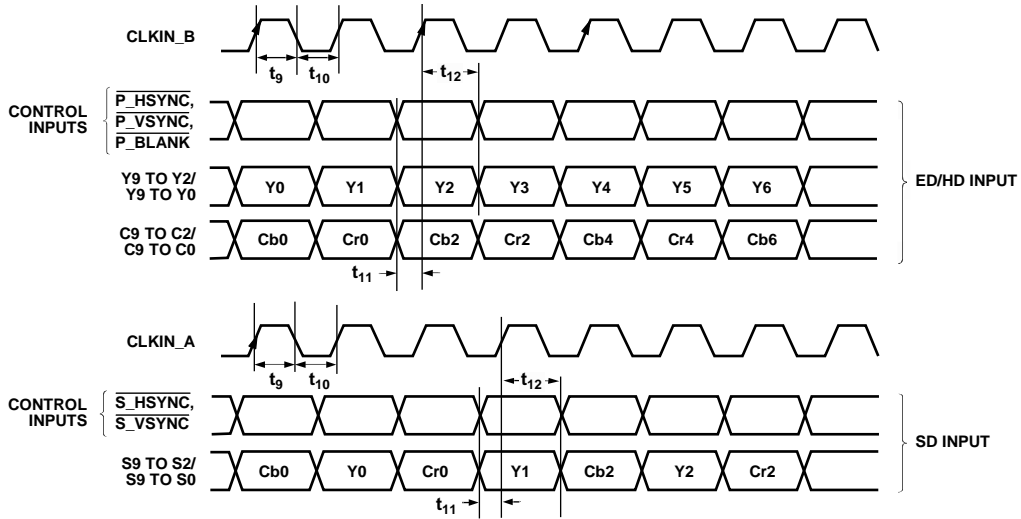

Figure 10. SD, ED/HD-SDR Input Mode, 16-/20-Bit, 4:2:2 ED/HD and 8-/10-Bit, SD Pixel Input Mode (Input Mode 011)

06398-010

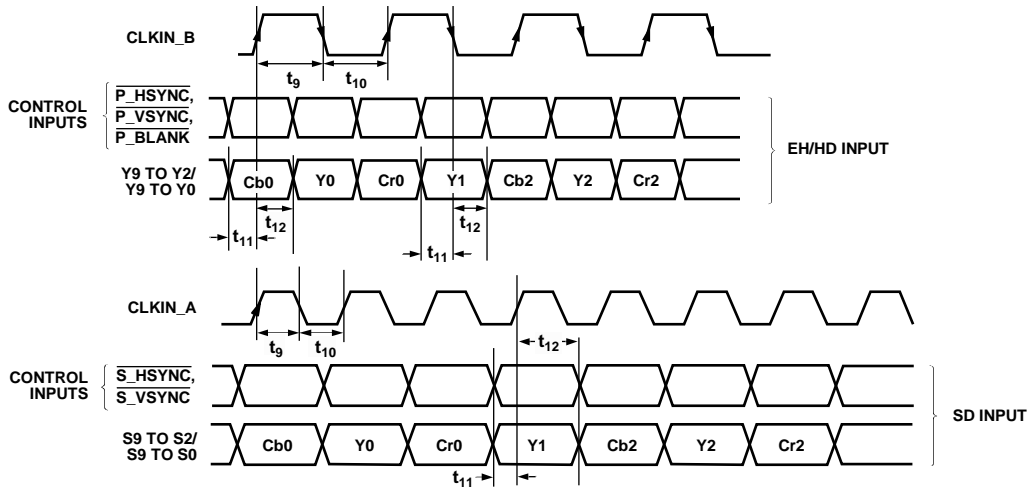

Figure 11. SD, ED/HD-DDR Input Mode, 8-/10-Bit, 4:2:2 ED/HD and 8-/10-Bit, SD Pixel Input Mode (Input Mode 100)

06398-011

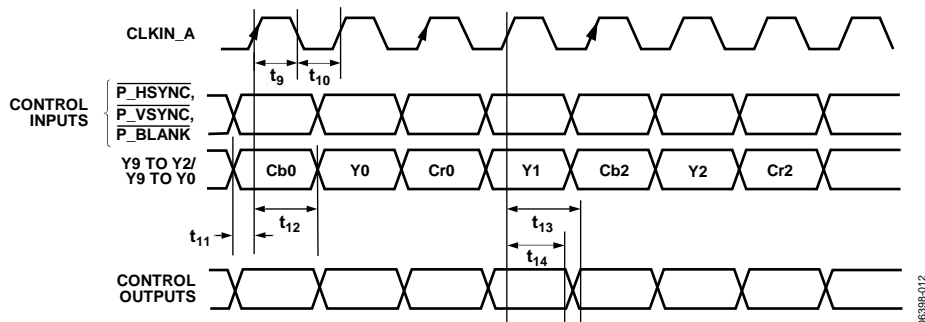

Figure 12. ED Only (at 54 MHz), 8-/10-Bit, 4:2:2 YCrCb (HSYNC/VSYNC) Pixel Input Mode (Input Mode 111)

06398-012

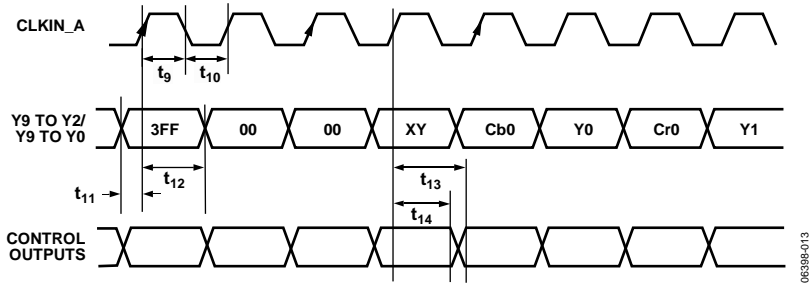
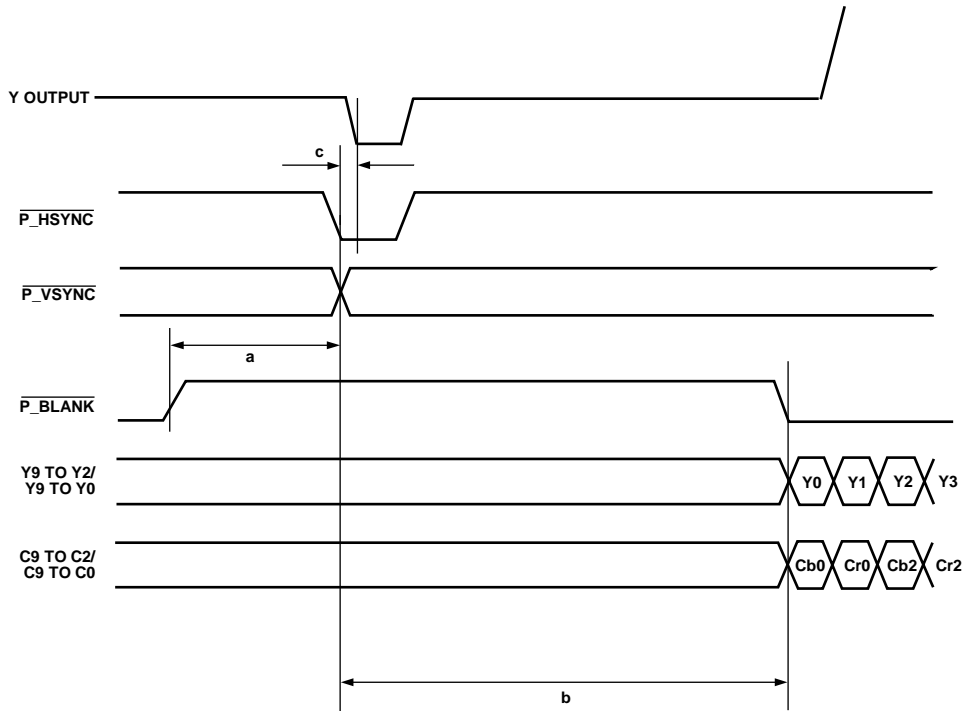

Figure 13. ED Only (at 54 MHz), 8-/10-Bit, 4:2:2 YCrCb (EAV/SAV) Pixel Input Mode (Input Mode 111)



a AND b AS PER RELEVANT STANDARD.

c = PIPELINE DELAY. PLEASE REFER TO RELEVANT PIPELINE DELAY. THIS CAN BE FOUND IN THE DIGITAL TIMING SPECIFICATION SECTION OF THE DATA SHEET.

A FALLING EDGE OF $\overline{\text{HSYNC}}$ INTO THE ENCODER GENERATES A SYNC FALLING EDGE ON THE OUTPUT AFTER A TIME EQUAL TO THE PIPELINE DELAY.

Figure 14. ED-SDR, 16-/20-Bit, 4:2:2 YCrCb ($\overline{\text{HSYNC}}/\overline{\text{VSYNC}}$) Input Timing Diagram

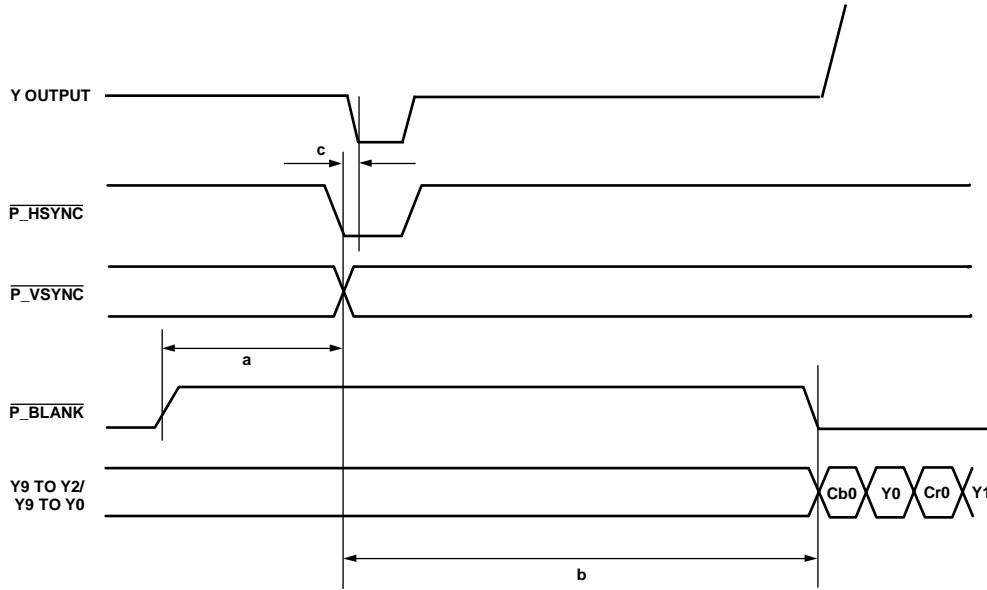

a = 32 CLKCYCLES FOR 525p
 a = 24 CLKCYCLES FOR 625p
 AS RECOMMENDED BY STANDARD

b(MIN) = 244 CLKCYCLES FOR 525p
 b(MIN) = 264 CLKCYCLES FOR 625p

c = PIPELINE DELAY. PLEASE REFER TO RELEVANT PIPELINE DELAY. THIS CAN BE FOUND IN THE DIGITAL TIMING SPECIFICATION SECTION OF THE DATA SHEET.

A FALLING EDGE OF $\overline{\text{HSYNC}}$ INTO THE ENCODER GENERATES A SYNC FALLING EDGE ON THE OUTPUT AFTER A TIME EQUAL TO THE PIPELINE DELAY.

Figure 15. ED-DDR, 8-/10-Bit, 4:2:2 YCrCb ($\overline{\text{HSYNC}}/\overline{\text{VSYNC}}$) Input Timing Diagram

06398-015

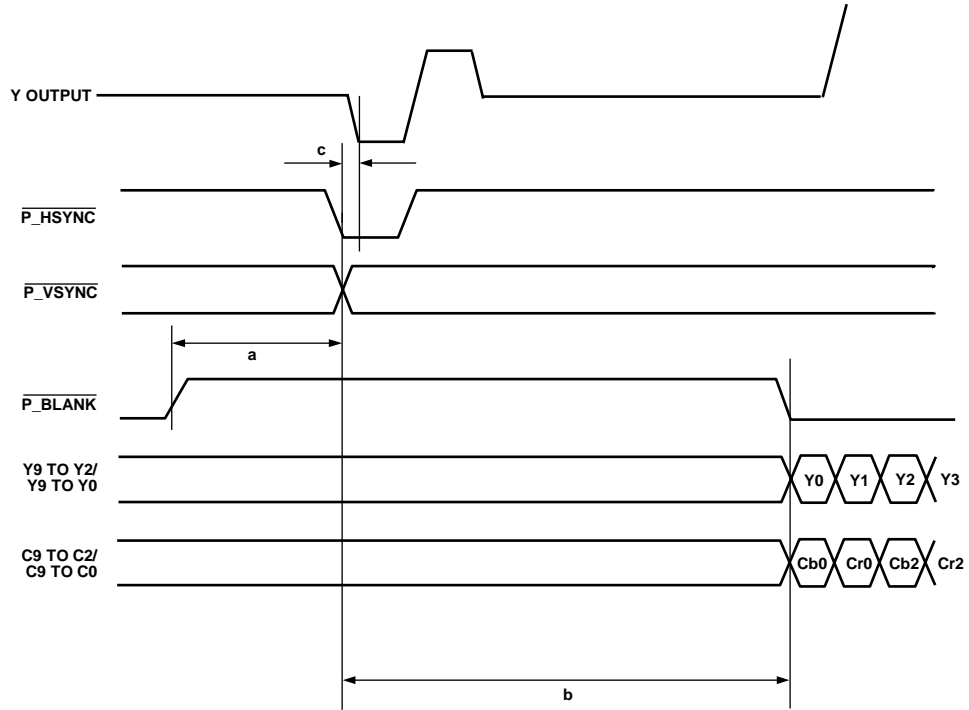

a AND b AS PER RELEVANT STANDARD.

c = PIPELINE DELAY. PLEASE REFER TO RELEVANT PIPELINE DELAY. THIS CAN BE FOUND IN THE DIGITAL TIMING SPECIFICATION SECTION OF THE DATA SHEET.

A FALLING EDGE OF HSYNC INTO THE ENCODER GENERATES A FALLING EDGE OF TRI-LEVEL SYNC ON THE OUTPUT AFTER A TIME EQUAL TO THE PIPELINE DELAY.

06398-016

Figure 16. HD-SDR, 16-/20-Bit, 4:2:2 YCrCb (HSYNC/VSYNC) Input Timing Diagram

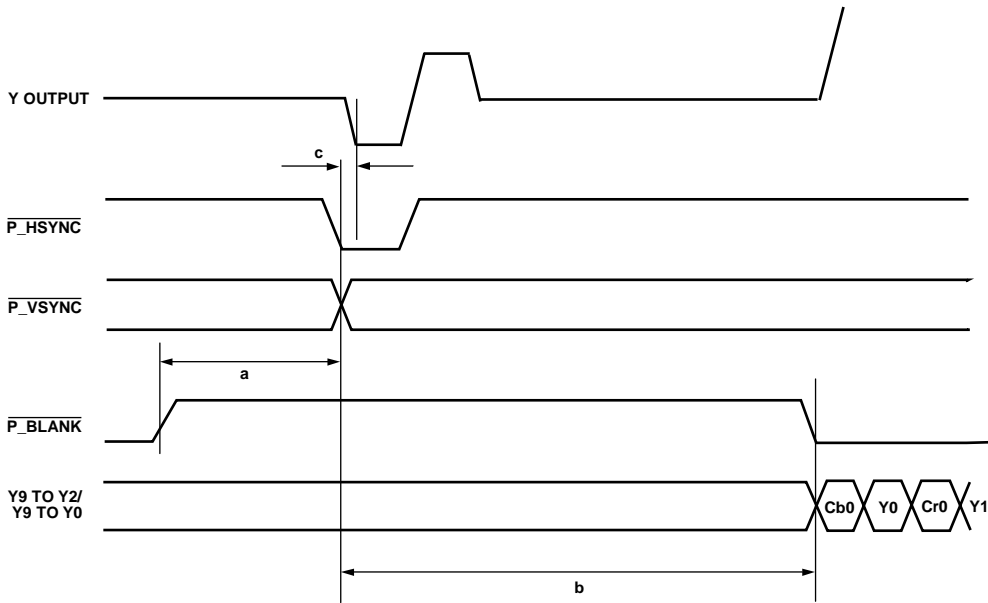

a AND b AS PER RELEVANT STANDARD.

c = PIPELINE DELAY. PLEASE REFER TO RELEVANT PIPELINE DELAY. THIS CAN BE FOUND IN THE DIGITAL TIMING SPECIFICATION SECTION OF THE DATA SHEET.

A FALLING EDGE OF HSYNC INTO THE ENCODER GENERATES A FALLING EDGE OF TRI-LEVEL SYNC ON THE OUTPUT AFTER A TIME EQUAL TO THE PIPELINE DELAY.

06398-017

Figure 17. HD-DDR, 8-/10-Bit, 4:2:2 YCrCb (HSYNC/VSYNC) Input Timing Diagram

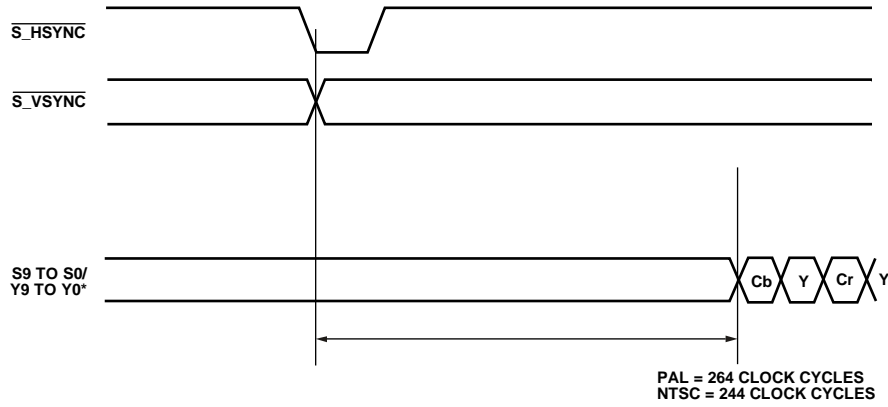

*SELECTED BY SUBADDRESS 0x01, BIT 7.

Figure 18. SD Input Timing Diagram (Timing Mode 1)

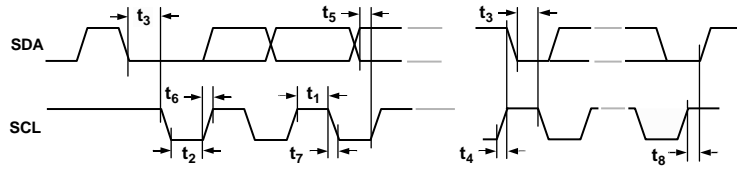

Figure 19. MPU Port Timing Diagram (I²C Mode)

ABSOLUTE MAXIMUM RATINGS

Table 13.

Parameter ¹	Rating
V _{AA} to AGND	−0.3 V to +3.9 V
V _{DD} to DGND	−0.3 V to +2.3 V
PV _{DD} to PGND	−0.3 V to +2.3 V
V _{DD_IO} to GND_IO	−0.3 V to +3.9 V
AGND to DGND	−0.3 V to +0.3 V
AGND to PGND	−0.3 V to +0.3 V
AGND to GND_IO	−0.3 V to +0.3 V
DGND to PGND	−0.3 V to +0.3 V
DGND to GND_IO	−0.3 V to +0.3 V
PGND to GND_IO	−0.3 V to +0.3 V
Digital Input Voltage to GND_IO	−0.3 V to V _{DD_IO} + 0.3 V
Analog Outputs to AGND	−0.3 V to V _{AA}
Maximum CLKIN Input Frequency	80 MHz
Storage Temperature Range (T _s)	−65°C to +150°C
Junction Temperature (T _j)	150°C
Lead Temperature (Soldering, 10 sec)	260°C

¹ Analog output short circuit to any power supply or common can be of an indefinite duration.

Stresses above those listed under Absolute Maximum Ratings may cause permanent damage to the device. This is a stress rating only; functional operation of the device at these or any other conditions above those indicated in the operational section of this specification is not implied. Exposure to absolute maximum rating conditions for extended periods may affect device reliability.

The ADV7340/ADV7341 are high performance integrated circuits with an ESD rating of <1 kV, and they are ESD sensitive. Proper precautions should be taken for handling and assembly.

THERMAL RESISTANCE

θ_{JA} is specified for the worst-case conditions, that is, a device soldered in a circuit board for surface-mount packages.

Table 14. Thermal Resistance¹

Package Type	θ_{JA}	θ_{JC}	Unit
64-Lead LQFP	47	11	°C/W

¹ Values are based on a JEDEC 4-layer test board.

The ADV7340/ADV7341 are RoHS-compliant, Pb-free products. The lead finish is 100% pure Sn electroplate. The devices are suitable for Pb-free applications up to 255°C (±5°C) IR reflow (JEDEC STD-20).

Each part is backward compatible with conventional SnPb soldering processes. The electroplated Sn coating can be soldered with Sn/Pb solder paste at conventional reflow temperatures of 220°C to 235°C.

ESD CAUTION



ESD (electrostatic discharge) sensitive device. Charged devices and circuit boards can discharge without detection. Although this product features patented or proprietary protection circuitry, damage may occur on devices subjected to high energy ESD. Therefore, proper ESD precautions should be taken to avoid performance degradation or loss of functionality.

PIN CONFIGURATION AND FUNCTION DESCRIPTIONS

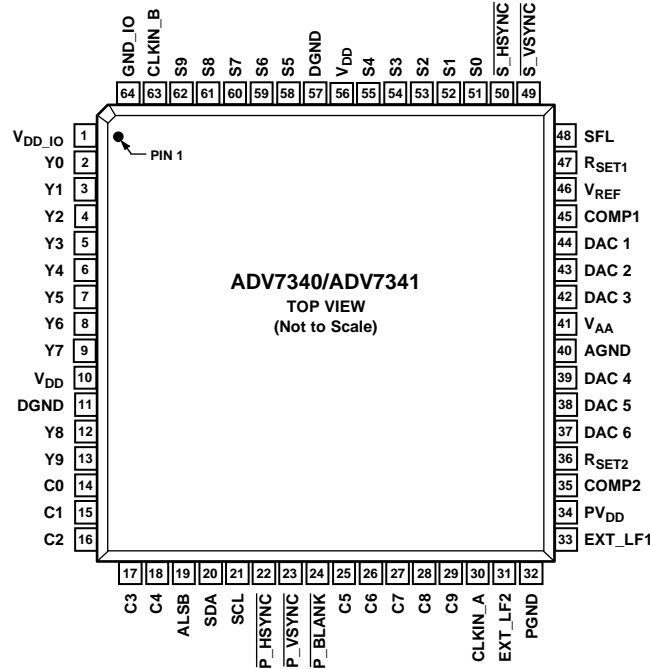

Figure 20. Pin Configuration

Table 15. Pin Function Descriptions

Pin No.	Mnemonic	Input/Output	Description
13, 12, 9 to 2	Y9 to Y0	I	10-Bit Pixel Port (Y9 to Y0). Y0 is the LSB. Refer to Table 36 for input modes.
29 to 25, 18 to 14	C9 to C0	I	10-Bit Pixel Port (C9 to C0). C0 is the LSB. Refer to Table 36 for input modes.
62 to 58, 55 to 51	S9 to S0	I	10-Bit Pixel Port (S9 to S0). S0 is the LSB. Refer to Table 36 for input modes.
30	CLKIN_A	I	Pixel Clock Input for HD Only (74.25 MHz), ED ¹ Only (27 MHz or 54 MHz), or SD Only (27 MHz).
63	CLKIN_B	I	Pixel Clock Input for Dual Modes Only. Requires a 27 MHz reference clock for ED operation or a 74.25 MHz reference clock for HD operation.
50	$\overline{S_HSYNC}$	I/O	SD Horizontal Synchronization Signal. This pin can also be configured to output an SD, ED, or HD horizontal synchronization signal. See the External Horizontal and Vertical Synchronization Control section.
49	$\overline{S_VSYNC}$	I/O	SD Vertical Synchronization Signal. This pin can also be configured to output an SD, ED, or HD vertical synchronization signal. See the External Horizontal and Vertical Synchronization Control section.
22	$\overline{P_HSYNC}$	I	ED/HD Horizontal Synchronization Signal. See the External Horizontal and Vertical Synchronization Control section.
23	$\overline{P_VSYNC}$	I	ED/HD Vertical Synchronization Signal. See the External Horizontal and Vertical Synchronization Control section.
24	$\overline{P_BLANK}$	I	ED/HD Blanking Signal. See the External Horizontal and Vertical Synchronization Control section.
48	SFL	I/O	Subcarrier Frequency Lock (SFL) Input.
47	RSET1	I	This pin is used to control the amplitudes of the DAC 1, DAC 2, and DAC 3 outputs. For full-drive operation (for example, into a 37.5 Ω load), a 510 Ω resistor must be connected from RSET1 to AGND. For low-drive operation (for example, into a 300 Ω load), a 4.12 k Ω resistor must be connected from RSET1 to AGND.
36	RSET2	I	This pin is used to control the amplitudes of the DAC 4, DAC 5, and DAC 6 outputs. A 4.12 k Ω resistor must be connected from RSET2 to AGND.

Pin No.	Mnemonic	Input/ Output	Description
45, 35	COMP1, COMP2	O	Compensation Pins. Connect a 2.2 nF capacitor from both COMP pins to V _{AA} .
44, 43, 42	DAC 1, DAC 2, DAC 3	O	DAC Outputs. Full- and low-drive capable DACs.
39, 38, 37	DAC 4, DAC 5, DAC 6	O	DAC Outputs. Low-drive only capable DACs.
21	SCL	I	I ² C Clock Input.
20	SDA	I/O	I ² C Data Input/Output.
19	ALSB	I	This signal sets up the LSB ² of the MPU I ² C address (see the Power Supply Sequencing section for more information).
46	V _{REF}		Optional External Voltage Reference Input for DACs or Voltage Reference Output.
41	V _{AA}	P	Analog Power Supply (3.3 V).
10, 56	V _{DD}	P	Digital Power Supply (1.8 V). For dual-supply configurations, V _{DD} can be connected to other 1.8 V supplies through a ferrite bead or suitable filtering.
1	V _{DD_IO}	P	Input/Output Digital Power Supply (1.8 V or 3.3 V).
34	PV _{DD}	P	PLL Power Supply (1.8 V). For dual-supply configurations, PV _{DD} can be connected to other 1.8 V supplies through a ferrite bead or suitable filtering.
33	EXT_LF1	I	External Loop Filter for On-Chip PLL 1.
31	EXT_LF2	I	External Loop Filter for On-Chip PLL 2.
32	PGND	G	PLL Ground Pin.
40	AGND	G	Analog Ground Pin.
11, 57	DGND	G	Digital Ground Pin.
64	GND_IO	G	Input/Output Supply Ground Pin.

¹ ED = enhanced definition = 525p and 625p.

² LSB = least significant bit. In the ADV7340, setting the LSB to 0 sets the I²C address to 0xD4. Setting it to 1 sets the I²C address to 0xD6. In the ADV7341, setting the LSB to 0 sets the I²C address to 0x54. Setting it to 1 sets the I²C address to 0x56.

TYPICAL PERFORMANCE CHARACTERISTICS

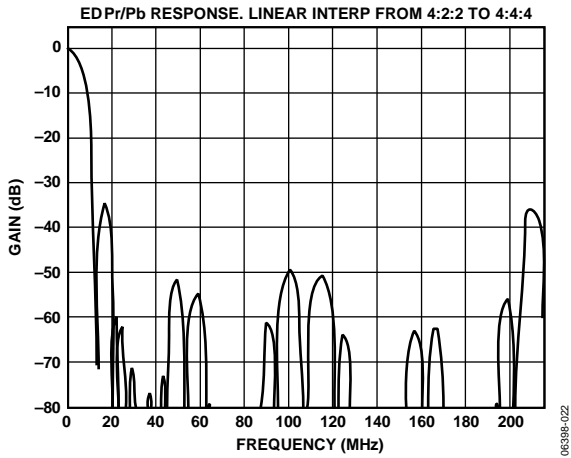

Figure 21. ED 8x Oversampling, PrPb Filter (Linear) Response

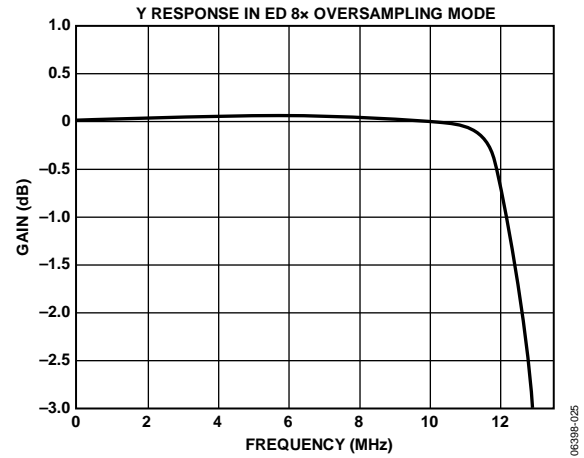

Figure 24. ED 8x Oversampling, Y Filter Response (Focus on Pass Band)

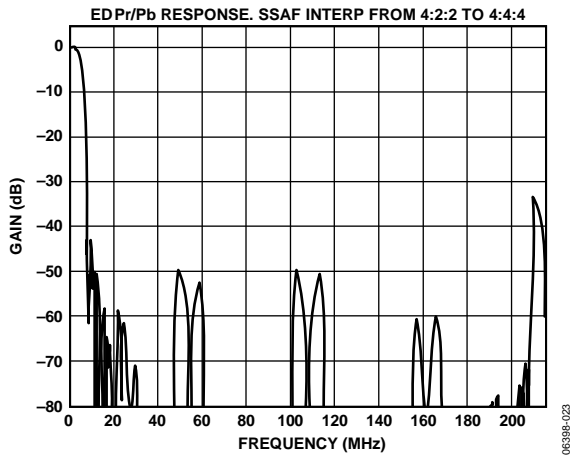

Figure 22. ED 8x Oversampling, PrPb Filter (SSAF™) Response

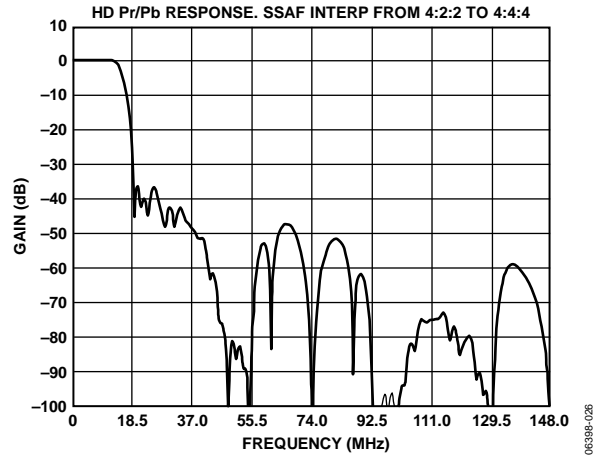

Figure 25. HD 4x Oversampling, PrPb (SSAF) Filter Response (4:2:2 Input)

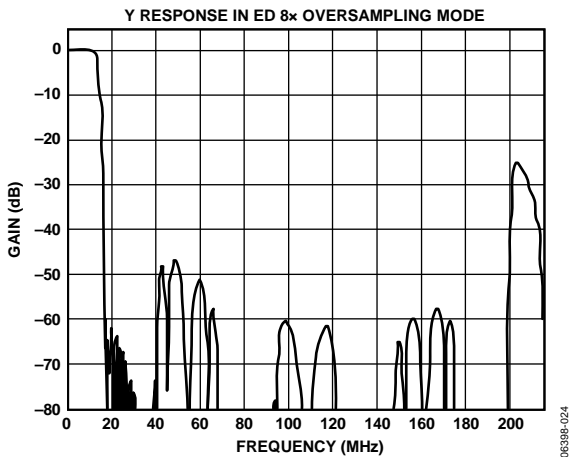

Figure 23. ED 8x Oversampling, Y Filter Response

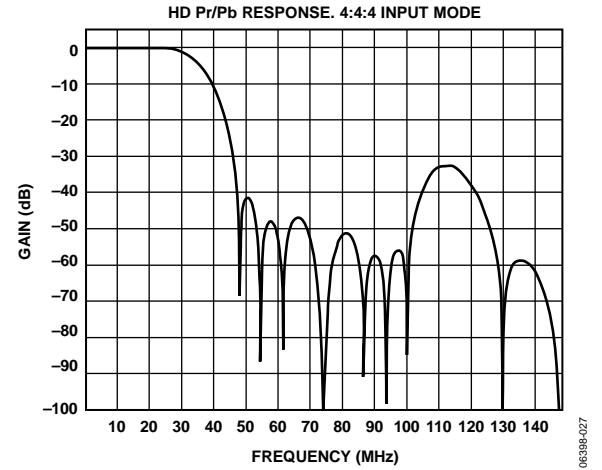

Figure 26. HD 4x Oversampling, PrPb (SSAF) Filter Response (4:4:4 Input)

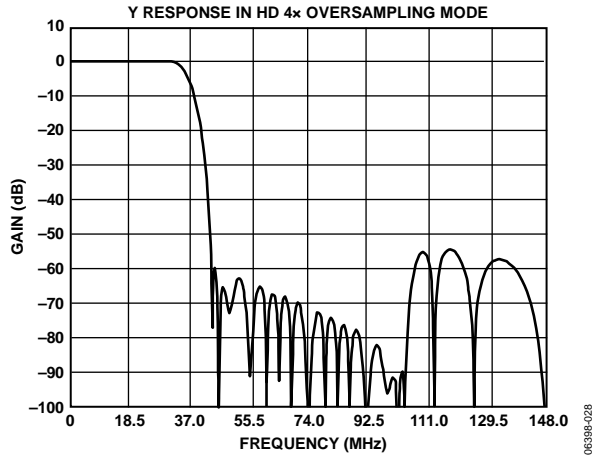

Figure 27. HD 4x Oversampling, Y Filter Response

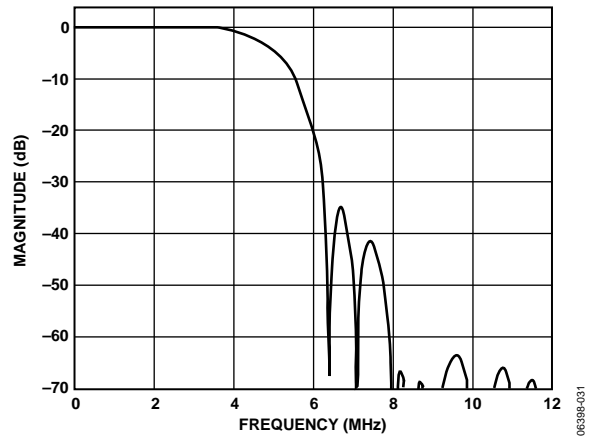

Figure 30. SD PAL, Luma Low-Pass Filter Response

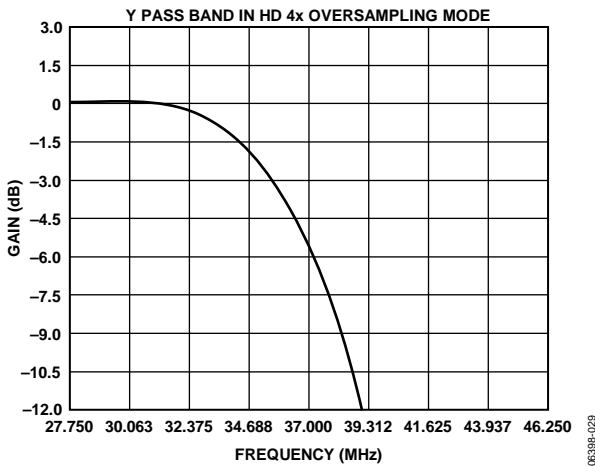

Figure 28. HD 4x Oversampling, Y Filter Response (Focus on Pass Band)

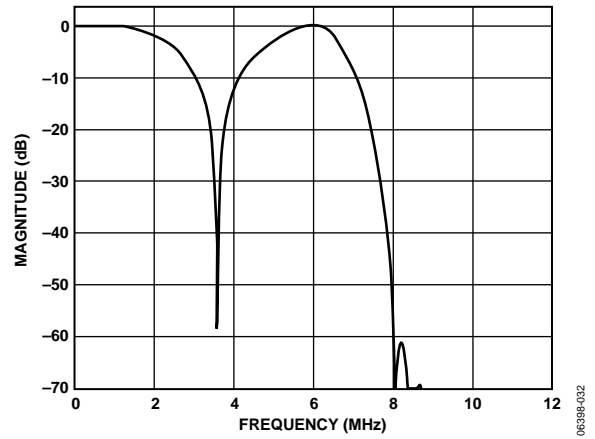

Figure 31. SD NTSC, Luma Notch Filter Response

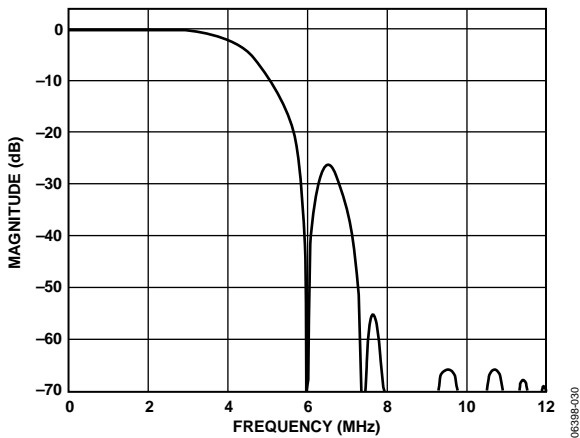

Figure 29. SD NTSC, Luma Low-Pass Filter Response

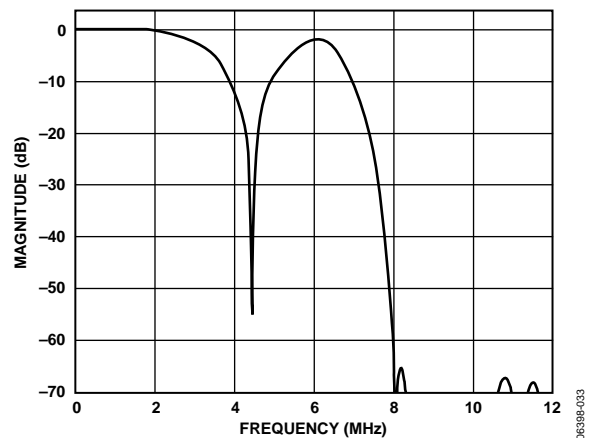

Figure 32. SD PAL, Luma Notch Filter Response

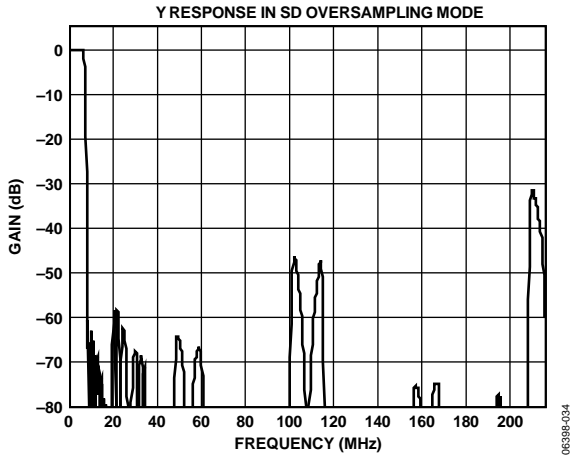

Figure 33. SD, 16x Oversampling, Y Filter Response

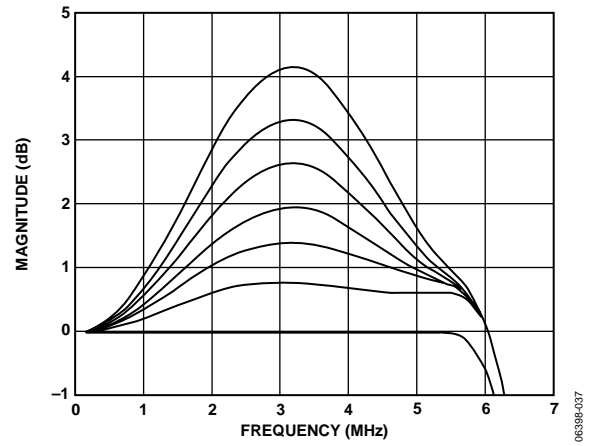

Figure 36. SD Luma SSAF Filter, Programmable Gain

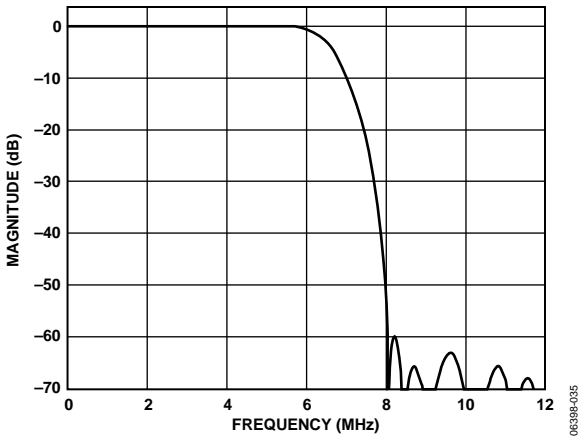

Figure 34. SD Luma SSAF Filter Response up to 12 MHz

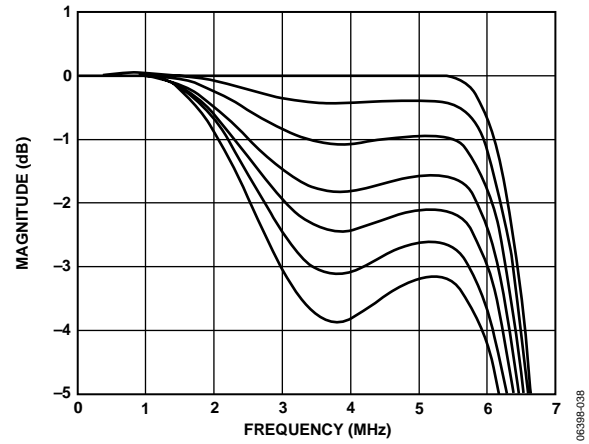

Figure 37. SD Luma SSAF Filter, Programmable Attenuation

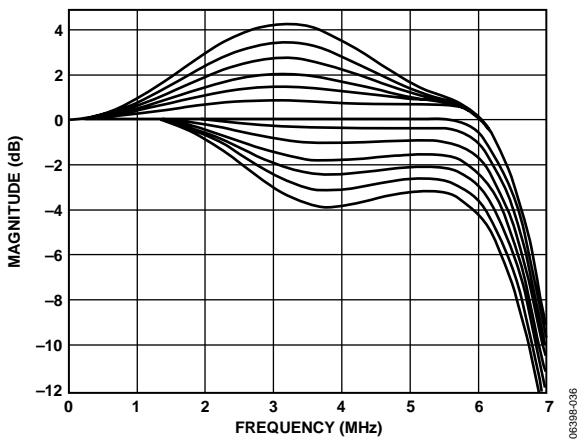

Figure 35. SD Luma SSAF Filter, Programmable Responses

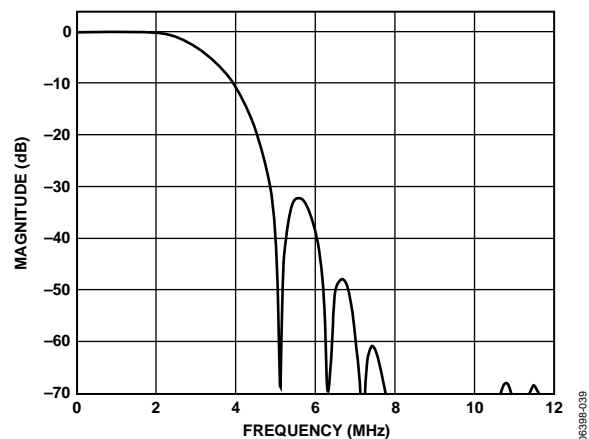

Figure 38. SD Luma CIF Low-Pass Filter Response

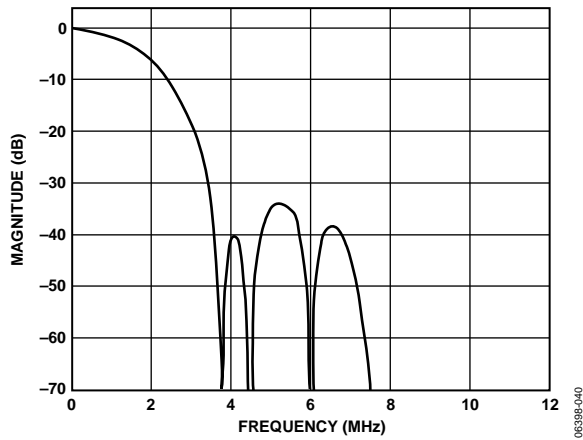

Figure 39. SD Luma QCIF Low-Pass Filter Response

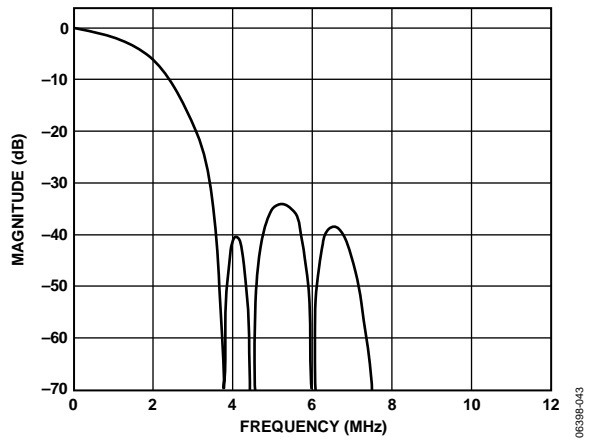

Figure 42. SD Chroma 1.3 MHz Low-Pass Filter Response

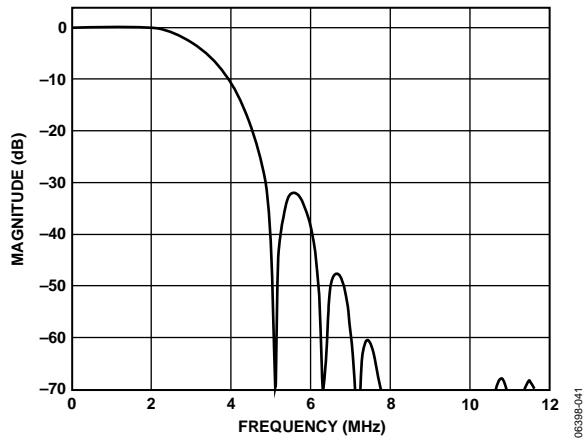

Figure 40. SD Chroma 3.0 MHz Low-Pass Filter Response

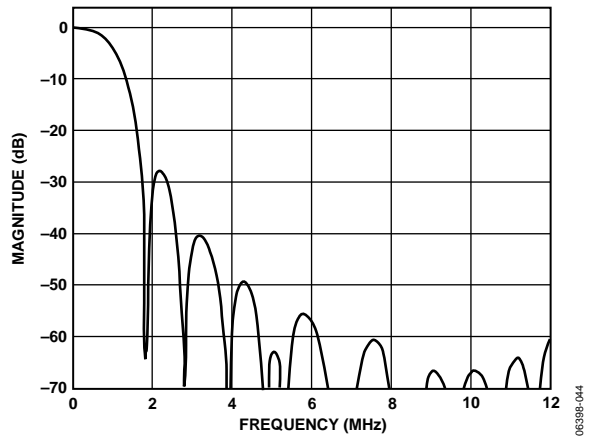

Figure 43. SD Chroma 1.0 MHz Low-Pass Filter Response

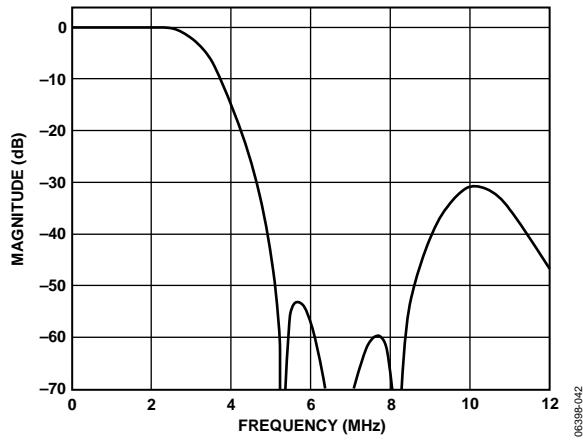

Figure 41. SD Chroma 2.0 MHz Low-Pass Filter Response

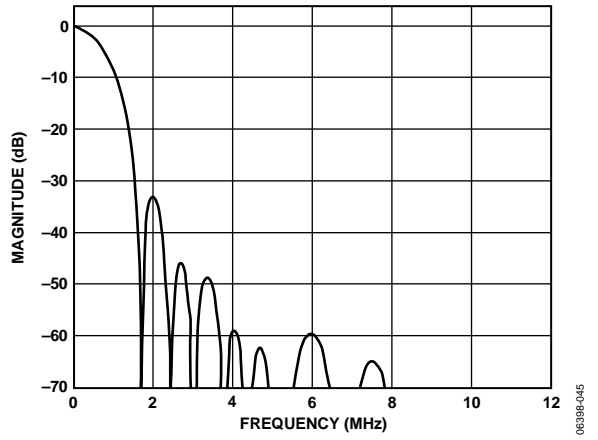

Figure 44. SD Chroma 0.65 MHz Low-Pass Filter Response

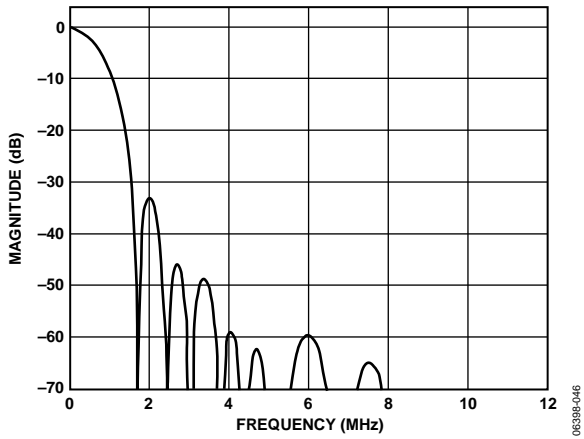

Figure 45. SD Chroma CIF Low-Pass Filter Response

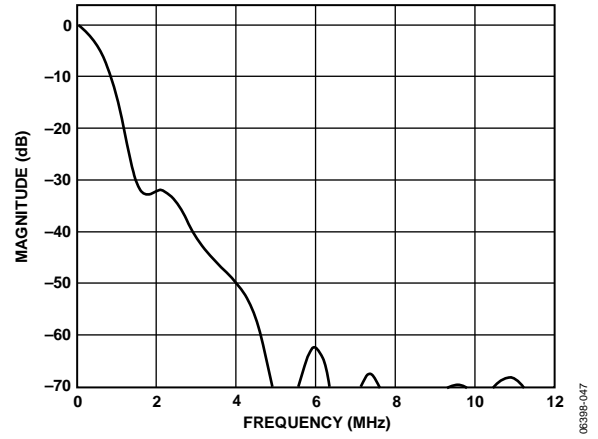

Figure 46. SD Chroma QCIF Low-Pass Filter Response

MPU PORT DESCRIPTION

Devices such as a microprocessor can communicate with the ADV7340/ADV7341 through a 2-wire serial (I²C-compatible) bus. After power-up or reset, the MPU port is configured for I²C operation.

I²C OPERATION

The ADV7340/ADV7341 support a 2-wire serial (I²C-compatible) microprocessor bus driving multiple peripherals. This port operates in an open-drain configuration. Two wires, serial data (SDA) and serial clock (SCL), carry information between any device connected to the bus and the ADV7340/ADV7341. The slave address of the device depends on the device (ADV7340 or ADV7341), the operation (read or write), and the state of the ALSB pin (0 or 1). See Table 16, Figure 47, and Figure 48. The LSB sets either a read or a write operation. Logic 1 corresponds to a read operation, and Logic 0 corresponds to a write operation. A1 is controlled by setting the ALSB pin of the ADV7340/ADV7341 to Logic 0 or Logic 1.

Table 16. ADV7340/ADV7341 I²C Slave Addresses

Device	ALSB	Operation	Slave Address
ADV7340	0	Write	0xD4
	0	Read	0xD5
	1	Write	0xD6
	1	Read	0xD7
ADV7341	0	Write	0x54
	0	Read	0x55
	1	Write	0x56
	1	Read	0x57

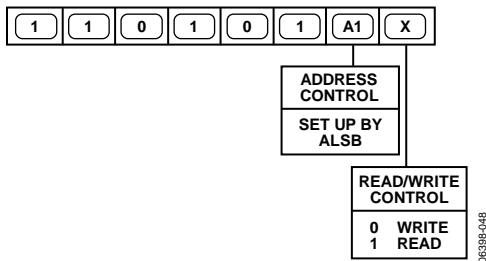

Figure 47. ADV7340 I²C Slave Address

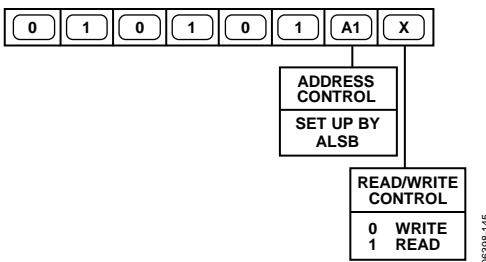

Figure 48. ADV7341 I²C Slave Address

Analog Devices, Inc., strongly recommends tying ALSB to V_{DD_IO}. If this is not done, a power supply sequence (PSS) may be required. For more information on the PSS, see the Power Supply

Sequencing section. The various devices on the bus use the following protocol. The master initiates a data transfer by establishing a start condition, defined by a high-to-low transition on SDA while SCL remains high. This indicates that an address/data stream follows. All peripherals respond to the start condition and shift the next eight bits (7-bit address plus the R/W bit). The bits are transferred from MSB down to LSB. The peripheral that recognizes the transmitted address responds by pulling the data line low during the ninth clock pulse. This is known as an acknowledge bit. All other devices withdraw from the bus at this point and maintain an idle condition. The idle condition occurs when the device monitors the SDA and SCL lines waiting for the start condition and the correct transmitted address. The R/W bit determines the direction of the data.

Logic 0 on the LSB of the first byte means that the master writes information to the peripheral. Logic 1 on the LSB of the first byte means that the master reads information from the peripheral.

The ADV7340/ADV7341 act as a standard slave device on the bus. The data on the SDA pin is eight bits long, supporting the 7-bit addresses plus the R/W bit. It interprets the first byte as the device address and the second byte as the starting subaddress. There is a subaddress auto-increment facility. This allows data to be written to or read from registers in ascending subaddress sequence starting at any valid subaddress. A data transfer is always terminated by a stop condition. The user can also access any unique subaddress register on a one-by-one basis without updating all the registers.

Stop and start conditions can be detected at any stage during the data transfer. If these conditions are asserted out of sequence with normal read and write operations, they cause an immediate jump to the idle condition. During a given SCL high period, the user should issue only a start condition, a stop condition, or a stop condition followed by a start condition. If an invalid subaddress is issued by the user, the ADV7340/ADV7341 do not issue an acknowledge but return to the idle condition. If the user uses the auto-increment method of addressing the encoder and exceeds the highest subaddress, the following actions are taken:

- In read mode, the highest subaddress register contents are output until the master device issues a no acknowledge. This indicates the end of a read. A no acknowledge condition occurs when the SDA line is not pulled low on the ninth pulse.
- In write mode, the data for the invalid byte is not loaded into any subaddress register, a no acknowledge is issued by the ADV7340/ADV7341, and the parts return to the idle condition.

Figure 49 shows a data transfer for a write sequence and the start and stop conditions. Figure 50 shows bus write and read sequences.

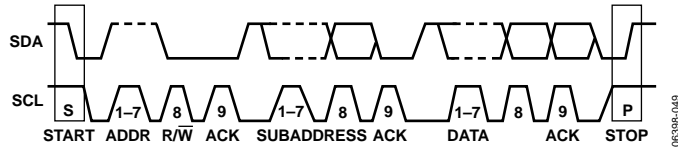

Figure 49. I²C Data Transfer

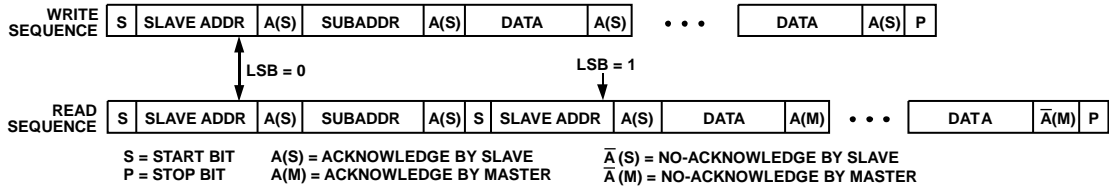

Figure 50. I²C Read and Write Sequence

REGISTER MAP ACCESS

A microprocessor can read from or write to all registers of the ADV7340/ADV7341 via the MPU port, except for registers that are specified as read-only or write-only registers.

The subaddress register determines which register the next read or write operation accesses. All communication through the MPU port starts with an access to the subaddress register. A read/write operation is then performed from/to the target address, which increments to the next address until the transaction is complete.

REGISTER PROGRAMMING

Table 17 to Table 35 describe the functionality of each register. All registers can be read from as well as written to, unless otherwise stated.

SUBADDRESS REGISTER (SR7 TO SR0)

The subaddress register is an 8-bit write-only register. After the MPU port is accessed and a read/write operation is selected, the subaddress is set up. The subaddress register determines to or from which register the operation takes place.

Table 17. Register 0x00

SR7 to SR0	Register	Bit Description	Bit Number								Register Setting	Reset Value	
			7	6	5	4	3	2	1	0			
0x00	Power mode	Sleep mode. With this control enabled, the current consumption is reduced to μ A level. All DACs and the internal PLL circuits are disabled. Registers can be read from and written to in sleep mode.									0	Sleep mode off	0x12
											1	Sleep mode on	
		PLL and oversampling control. This control allows the internal PLL 1 circuit to be powered down and the oversampling to be switched off.								0	PLL 1 on		
										1	PLL 1 off		
		DAC 3: power on/off.								0	DAC 3 off		
										1	DAC 3 on		
		DAC 2: power on/off.							0	DAC 2 off			
									1	DAC 2 on			
DAC 1: power on/off.						0	DAC 1 off						
						1	DAC 1 on						
DAC 6: power on/off.				0				DAC 6 off					
				1				DAC 6 on					
DAC 5: power on/off.						0	DAC 5 off						
						1	DAC 5 on						
DAC 4: power on/off.							0	DAC 4 off					
							1	DAC 4 on					

Table 18. Register 0x01 to Register 0x09

SR7 to SR0	Register	Bit Description	Bit Number ¹								Register Setting	Reset Value	
			7	6	5	4	3	2	1	0			
0x01	Mode select	Reserved.									0		0x00
		DDR clock edge alignment (only used for ED ² and HD DDR modes)							0	0	Chroma clocked in on rising clock edge; luma clocked in on falling clock edge		
									0	1	Reserved		
									1	0	Reserved		
									1	1	Luma clocked in on rising clock edge; chroma clocked in on falling clock edge		
		Reserved.					0						
		Input mode (see Subaddress 0x30, Bits[7:3] for ED/HD standard selection)		0	0	0					SD input only		
				0	0	1					ED/HD-SDR input only		
	0		1	0					ED/HD-DDR input only				
	0		1	1					SD and ED/HD-SDR				
	1		0	0					SD and ED/HD-DDR				
	1	0	1					Reserved					
	1	1	0					Reserved					
	1	1	1					ED only (at 54 MHz)					
Y/C/S bus swap	0							Allows data to be applied to data ports in various configurations (SD feature only)					
	1												

SR7 to SR0	Register	Bit Description	Bit Number ¹								Register Setting	Reset Value	
			7	6	5	4	3	2	1	0			
0x02	Mode Register 0	Reserved.									0	0 must be written to this bit.	0x20
		HD interlace external \overline{VSYNC} and \overline{HSYNC}								0 1	Default. If using HD $\overline{HSYNC}/\overline{VSYNC}$ interlace mode, setting this bit to 1 is recommended (see the HD Interlace External P_ \overline{HSYNC} and P_ \overline{VSYNC} Considerations section for more information).		
		Test pattern black bar. ³							0 1	Disabled. Enabled.			
		Manual CSC matrix adjust					0 1			Disable manual CSC matrix adjust. Enable manual CSC matrix adjust.			
		Sync on RGB				0 1			No sync. Sync on all RGB outputs.				
		RGB/YPrPb output select			0 1			RGB component outputs. YPrPb component outputs.					
		SD sync output enable		0 1			No sync output. Output SD syncs on the \overline{HSYNC} and \overline{VSYNC} pins.						
		ED/HD sync output enable	0 1			No sync output. Output ED/HD syncs on the \overline{HSYNC} and \overline{VSYNC} pins.							
0x03	ED/HD CSC Matrix 0							x	x	LSBs for GY.	0x03		
0x04	ED/HD CSC Matrix 1							x	x	LSBs for RV. LSBs for BU. LSBs for GV. LSBs for GU.	0xF0		
		x	x										
0x05	ED/HD CSC Matrix 2	x	x	x	x	x	x	x	x	Bits[9:2] for GY.	0x4E		
0x06	ED/HD CSC Matrix 3	x	x	x	x	x	x	x	x	Bits[9:2] for GU.	0x0E		
0x07	ED/HD CSC Matrix 4	x	x	x	x	x	x	x	x	Bits[9:2] for GV.	0x24		
0x08	ED/HD CSC Matrix 5	x	x	x	x	x	x	x	x	Bits[9:2] for BU.	0x92		
0x09	ED/HD CSC Matrix 6	x	x	x	x	x	x	x	x	Bits[9:2] for RV.	0x7C		

¹ x = Logic 0 or Logic 1.

² ED = enhanced definition = 525p and 625p.

³ Subaddress 0x31, Bit 2 must also be enabled (ED/HD). Subaddress 0x84, Bit 6 must also be enabled (SD).

Table 19. Register 0x0A to Register 0x10

SR7 to SR0	Register	Bit Description	Bit Number								Register Setting	Reset Value	
			7	6	5	4	3	2	1	0			
0x0A	DAC 4, DAC 5, DAC 6 output levels	Positive gain to DAC output voltage	0	0	0	0	0	0	0	0	0	0%	0x00
			0	0	0	0	0	0	0	1	+0.018%		
			0	0	0	0	0	0	1	0	+0.036%		
				
			0	0	1	1	1	1	1	1	+7.382%		
		0	1	0	0	0	0	0	0	+7.5%			
		Negative gain to DAC output voltage	1	1	0	0	0	0	0	0	-7.5%		
			1	1	0	0	0	0	0	1	-7.382%		
			1	0	0	0	0	0	1	0	-7.364%		
				
1	1		1	1	1	1	1	1	-0.018%				
0x0B	DAC 1, DAC 2, DAC 3 output levels	Positive gain to DAC output voltage	0	0	0	0	0	0	0	0	0%	0x00	
			0	0	0	0	0	0	0	1	+0.018%		
			0	0	0	0	0	0	1	0	+0.036%		
				
			0	0	1	1	1	1	1	1	+7.382%		
		0	1	0	0	0	0	0	0	+7.5%			
		Negative Gain to DAC Output Voltage	1	1	0	0	0	0	0	0	-7.5%		
			1	1	0	0	0	0	0	1	-7.382%		
			1	0	0	0	0	0	1	0	-7.364%		
				
1	1		1	1	1	1	1	1	-0.018%				
0x0D	DAC power mode	DAC 1 low power enable								0 1	DAC 1 low power disabled DAC 1 low power enabled	0x00	
		DAC 2 low power enable							0 1	DAC 2 low power disabled DAC 2 low power enabled			
		DAC 3 low power enable						0 1		DAC 3 low power disabled DAC 3 low power enabled			
		Reserved	0	0	0	0	0						
0x10	Cable detection	DAC 1 cable detect (read only)								0 1	Cable detected on DAC 1 DAC 1 unconnected	0x00	
		DAC 2 cable detect (read only)							0 1	Cable detected on DAC 2 DAC 2 unconnected			
		Reserved.					0	0					
		Unconnected DAC autopower-down				0 1					DAC autopower-down disable DAC autopower-down enable		
		Reserved	0	0	0								

Table 20. Register 0x12 to Register 0x17

SR7 to SR0	Register	Bit Description	Bit Number ¹								Register Setting	Reset Value	
			7	6	5	4	3	2	1	0			
0x12	Pixel port readback (S bus MSBs)	S[9:2] readback	x	x	x	x	x	x	x	x	x	Read only.	0xXX
0x13	Pixel port readback (Y bus MSBs)	Y[9:2] readback	x	x	x	x	x	x	x	x	x	Read only.	0xXX
0x14	Pixel port readback (C bus MSBs)	C[9:2] readback	x	x	x	x	x	x	x	x	x	Read only.	0xXX
0x15	Pixel port readback (S, Y, and C bus LSBs)	C[1:0] readback Y[1:0] readback S[1:0] readback Reserved						x	x		x	Read only.	0xXX
0x16	Control port readback	P_BLANK P_VSYNC P_HSYNC S_VSYNC S_HSYNC SFL Reserved									x	Read only.	0xXX
0x17	Software reset	Reserved									0		0x00
		Software reset							0	1		Writing a 1 resets the device; this is a self-clearing bit.	
		Reserved	0	0	0	0	0	0					

¹x = Logic 0 or Logic 1.

Table 21. Register 0x30

SR7 to SR0	Register	Bit Description	Bit Number								Register Setting	Note	Reset Value	
			7	6	5	4	3	2	1	0				
0x30	ED/HD Mode Register 1	ED/HD output standard								0	0	EIA770.2 output, EIA770.3 output	ED HD	0x00
										0	1	EIA770.1 output		
										1	0	Output levels for full input range		
		ED/HD input synchronization format								0		External HSYNC, VSYNC and field inputs ¹		
										1		Embedded EAV/SAV codes		
		ED/HD standard ²	0	0	0	0	0					SMPTE 293M, ITU-BT.1358	525p at 59.94 Hz	
			0	0	0	1	0					BTA-1004, ITU-BT.1362	525p at 59.94 Hz	
			0	0	0	1	1					ITU-BT.1358	625p at 50 Hz	
			0	0	1	0	0					ITU-BT.1362	625p at 50 Hz	
			0	0	1	0	1					SMPTE 296M-1, SMPTE 274M-2	720p at 60/59.94 Hz	
			0	0	1	1	0					SMPTE 296M-3	720p at 50 Hz	
			0	0	1	1	1					SMPTE 296M-4, SMPTE 274M-5	720p at 30/29.97 Hz	
			0	1	0	0	0					SMPTE 296M-6.	720p at 25 Hz	
			0	1	0	0	1					SMPTE 296M-7, SMPTE 296M-8	720p at 24/23.98 Hz	
			0	1	0	1	0					SMPTE 240M	1035i at 60/59.94 Hz	
			0	1	0	1	1					Reserved		
			0	1	1	0	0					Reserved		
			0	1	1	0	1					SMPTE 274M-4, SMPTE 274M-5	1080i at 30/29.97 Hz	
			0	1	1	1	0					SMPTE 274M-6	1080i at 25 Hz	
			0	1	1	1	1					SMPTE 274M-7, SMPTE 274M-8	1080p at 30/29.97 Hz	
			1	0	0	0	0					SMPTE 274M-9	1080p at 25 Hz	
			1	0	0	0	1					SMPTE 274M-10, SMPTE 274M-11	1080p at 24/23.98 Hz	
			1	0	0	1	0					ITU-R BT.709-5	1080Psf at 24 Hz	
			10011–11111										Reserved	

¹ Synchronization can be controlled with a combination of either HSYNC and VSYNC inputs or HSYNC and field inputs, depending on Subaddress 0x34, Bit 6.

² See the HD Interlace External P_HSYNC and P_VSYNC Considerations section for more information.

Table 22. Register 0x31 to Register 0x33

SR7 to SR0	Register	Bit Description	Bit Number								Register Setting	Reset Value			
			7	6	5	4	3	2	1	0					
0x31	ED/HD Mode Register 2	ED/HD pixel data valid									0	Pixel data valid off.	0x00		
											1	Pixel data valid on.			
		Reserved									0				
		ED/HD test pattern enable								0		ED/HD test pattern off.			
										1		ED/HD test pattern on.			
		ED/HD test pattern hatch/field						0				Hatch.			
								1				Field/frame.			
ED/HD VBI open				0							Disabled.				
				1							Enabled.				
ED/HD undershoot limiter		0	0								Disabled.				
		0	1								-11 IRE.				
		1	0								-6 IRE.				
		1	1								-1.5 IRE.				
ED/HD sharpness filter		0									Disabled.				
		1									Enabled.				
0x32	ED/HD Mode Register 3	ED/HD Y delay with respect to the falling edge of HSYNC							0	0	0	0 clock cycles.	0x00		
									0	0	1	One clock cycle.			
										0	1	0		Two clock cycles.	
											0	1		1	Three clock cycles.
											1	0		0	Four clock cycles.
		ED/HD color delay with respect to the falling edge of HSYNC			0	0	0							0 clock cycles.	
					0	0	1							One clock cycle.	
			0	1	0						Two clock cycles.				
			0	1	1						Three clock cycles.				
			1	0	0						Four clock cycles.				
ED/HD CGMS		0									Disabled.				
		1									Enabled.				
ED/HD CGMS CRC		0									Disabled.				
		1									Enabled.				
0x33	ED/HD Mode Register 4	ED/HD Cr/Cb sequence									0	Cb after falling edge of $\overline{\text{HSYNC}}$.	0x68		
											1	Cr after falling edge of $\overline{\text{HSYNC}}$.			
		Reserved									0	0 must be written to this bit.			
		ED/HD input format								0		8-bit input.			
										1		10-bit input.			
		Sinc compensation filter on DAC 1, DAC 2, DAC 3						0						Disabled.	
								1						Enabled.	
Reserved					0						0 must be written to this bit.				
ED/HD chroma SSAF			0								Disabled.				
			1								Enabled.				
ED/HD chroma input		0									4:4:4.				
		1									4:2:2.				
ED/HD double buffering		0									Disabled.				
		1									Enabled.				

Table 23. Register 0x34 to Register 0x35

SR7 to SR0	Register	Bit Description	Bit Number								Register Setting	Reset Value	
			7	6	5	4	3	2	1	0			
0x34	ED/HD Mode Register 5	ED/HD timing reset									0 1	Internal ED/HD timing counters enabled Resets the internal ED/HD timing counters	0x48
		ED/HD HSYNC control ¹									0 1	HSYNC output control (refer to Table 56)	
		ED/HD VSYNC control ¹								0 1		VSYNC output control (refer to Table 57)	
		ED/HD blank polarity					0 1					P_BLANK active high P_BLANK active low	
		ED Macrovision® enable				0 1						Macrovision disabled Macrovision enabled	
		Reserved			0							0 must be written to this bit	
		ED/HD VSYNC/field input		0 1								0 = field input 1 = VSYNC input	
		Horizontal/vertical counters ²	0 1									Update field/line counter Field/line counter free running	
0x35	ED/HD Mode Register 6	Reserved									0		0x00
		ED/HD RGB input enable									0 1	Disabled. Enabled	
		ED/HD sync on PrPb							0 1			Disabled Enabled	
		ED/HD color DAC swap					0 1					DAC 2 = Pb, DAC 3 = Pr DAC 2 = Pr, DAC 3 = Pb	
		ED/HD gamma correction curve select				0 1						Gamma Correction Curve A Gamma Correction Curve B	
		ED/HD gamma correction enable			0 1							Disabled Enabled	
		ED/HD adaptive filter mode		0 1								Mode A Mode B	
		ED/HD adaptive filter enable	0 1									Disabled. Enabled	

¹ Used in conjunction with ED/HD sync output enable in Subaddress 0x02, Bit 7 = 1.

² When set to 0, the horizontal/vertical counters automatically wrap around at the end of the line/field/frame of the selected standard. When set to 1, the horizontal/vertical counters are free running and wrap around when external sync signals indicate to do so.

Table 24. Register 0x36 to Register 0x43

SR7 to SR0	Register	Bit Description	Bit Number ¹								Register Setting	Reset Value		
			7	6	5	4	3	2	1	0				
0x36	ED/HD Y level ²	ED/HD Test Pattern Y level	x	x	x	x	x	x	x	x	x	Y level value	0xA0	
0x37	ED/HD Cr level ²	ED/HD Test Pattern Cr level	x	x	x	x	x	x	x	x	x	Cr level value	0x80	
0x38	ED/HD Cb level ²	ED/HD Test Pattern Cb level	x	x	x	x	x	x	x	x	x	Cb level value	0x80	
0x39	ED/HD Mode Register 7	Reserved				0	0	0	0	0			0x00	
		ED/HD EIA/CEA-861B synchronization compliance			0							Disabled		Enabled
		Reserved	0	0										
0x3A	ED/HD Mode Register 8	INV_PHSYNC_POL									0	Disabled	0x00	
		INV_PVSYNC_POL								0	1	Disabled		Enabled
		INV_PBLANK_POL							0	1		Disabled		
		Reserved	0	0	0	0	0							
0x40	ED/HD sharpness filter gain	ED/HD sharpness filter gain, Value A						0	0	0	0	Gain A = 0	0x00	
		ED/HD sharpness filter gain, Value B	0	0	0	0						Gain B = 0		
0x41	ED/HD CGMS Data 0	ED/HD CGMS data bits	0	0	0	0	C19	C18	C17	C16	CGMS C19 to C16	0x00		
0x42	ED/HD CGMS Data 1	ED/HD CGMS data bits	C15	C14	C13	C12	C11	C10	C9	C8	CGMS C15 to C8	0x00		
0x43	ED/HD CGMS Data 2	ED/HD CGMS data bits	C7	C6	C5	C4	C3	C2	C1	C0	CGMS C7 to C0	0x00		

¹ x = Logic 0 or Logic 1.

² For use with ED/HD internal test patterns only (Subaddress 0x31, Bit 2 = 1).

Table 25. Register 0x44 to Register 0x57

SR7 to SR0	Register	Bit Description	Bit Number ¹								Register Setting	Reset Value
			7	6	5	4	3	2	1	0		
0x44	ED/HD Gamma A0	ED/HD Gamma Curve A (Point 24)	x	x	x	x	x	x	x	x	A0	0x00
0x45	ED/HD Gamma A1	ED/HD Gamma Curve A (Point 32)	x	x	x	x	x	x	x	x	A1	0x00
0x46	ED/HD Gamma A2	ED/HD Gamma Curve A (Point 48)	x	x	x	x	x	x	x	x	A2	0x00
0x47	ED/HD Gamma A3	ED/HD Gamma Curve A (Point 64)	x	x	x	x	x	x	x	x	A3	0x00
0x48	ED/HD Gamma A4	ED/HD Gamma Curve A (Point 80)	x	x	x	x	x	x	x	x	A4	0x00
0x49	ED/HD Gamma A5	ED/HD Gamma Curve A (Point 96)	x	x	x	x	x	x	x	x	A5	0x00
0x4A	ED/HD Gamma A6	ED/HD Gamma Curve A (Point 128)	x	x	x	x	x	x	x	x	A6	0x00
0x4B	ED/HD Gamma A7	ED/HD Gamma Curve A (Point 160)	x	x	x	x	x	x	x	x	A7	0x00
0x4C	ED/HD Gamma A8	ED/HD Gamma Curve A (Point 192)	x	x	x	x	x	x	x	x	A8	0x00
0x4D	ED/HD Gamma A9	ED/HD Gamma Curve A (Point 224)	x	x	x	x	x	x	x	x	A9	0x00
0x4E	ED/HD Gamma B0	ED/HD Gamma Curve B (Point 24)	x	x	x	x	x	x	x	x	B0	0x00
0x4F	ED/HD Gamma B1	ED/HD Gamma Curve B (Point 32)	x	x	x	x	x	x	x	x	B1	0x00
0x50	ED/HD Gamma B2	ED/HD Gamma Curve B (Point 48)	x	x	x	x	x	x	x	x	B2	0x00

SR7 to SR0	Register	Bit Description	Bit Number ¹								Register Setting	Reset Value
			7	6	5	4	3	2	1	0		
0x51	ED/HD Gamma B3	ED/HD Gamma Curve B (Point 64)	x	x	x	x	x	x	x	x	B3	0x00
0x52	ED/HD Gamma B4	ED/HD Gamma Curve B (Point 80)	x	x	x	x	x	x	x	x	B4	0x00
0x53	ED/HD Gamma B5	ED/HD Gamma Curve B (Point 96)	x	x	x	x	x	x	x	x	B5	0x00
0x54	ED/HD Gamma B6	ED/HD Gamma Curve B (Point 128)	x	x	x	x	x	x	x	x	B6	0x00
0x55	ED/HD Gamma B7	ED/HD Gamma Curve B (Point 160)	x	x	x	x	x	x	x	x	B7	0x00
0x56	ED/HD Gamma B8	ED/HD Gamma Curve B (Point 192)	x	x	x	x	x	x	x	x	B8	0x00
0x57	ED/HD Gamma B9	ED/HD Gamma Curve B (Point 224)	x	x	x	x	x	x	x	x	B9	0x00

¹x = Logic 0 or Logic 1.

Table 26. Register 0x58 to Register 0x5D

SR7 to SR0	Register	Bit Description	Bit Number ¹								Register Setting	Reset Value
			7	6	5	4	3	2	1	0		
0x58	ED/HD Adaptive Filter Gain 1	ED/HD Adaptive Filter Gain 1, Value A					0	0	0	0	Gain A = 0	0x00
						0	0	0	1	Gain A = +1		
							
						0	1	1	1	Gain A = +7		
						1	0	0	0	Gain A = -8		
							
						1	1	1	1	Gain A = -1		
		ED/HD Adaptive Filter Gain 1, Value B	0	0	0	0					Gain B = 0	
			0	0	0	1					Gain B = +1	
				
			0	1	1	1				Gain B = +7		
			1	0	0	0				Gain B = -8		
				
			1	1	1	1				Gain B = -1		
0x59	ED/HD Adaptive Filter Gain 2	ED/HD Adaptive Filter Gain 2, Value A					0	0	0	0	Gain A = 0	0x00
						0	0	0	1	Gain A = +1		
							
						0	1	1	1	Gain A = +7		
						1	0	0	0	Gain A = -8		
							
						1	1	1	1	Gain A = -1		
		ED/HD Adaptive Filter Gain 2, Value B	0	0	0	0					Gain B = 0	
			0	0	0	1					Gain B = +1	
				
			0	1	1	1				Gain B = +7		
			1	0	0	0				Gain B = -8		
				
			1	1	1	1				Gain B = -1		
0x5A	ED/HD Adaptive Filter Gain 3	ED/HD Adaptive Filter Gain 3, Value A					0	0	0	0	Gain A = 0	0x00
						0	0	0	1	Gain A = +1		
							
						0	1	1	1	Gain A = +7		
						1	0	0	0	Gain A = -8		
							
						1	1	1	1	Gain A = -1		
		ED/HD Adaptive Filter Gain 3, Value B	0	0	0	0					Gain B = 0	
			0	0	0	1					Gain B = +1	
				
			0	1	1	1				Gain B = +7		
			1	0	0	0				Gain B = -8		
				
			1	1	1	1				Gain B = -1		

SR7 to SR0	Register	Bit Description	Bit Number ¹								Register Setting	Reset Value	
			7	6	5	4	3	2	1	0			
0x5B	ED/HD Adaptive Filter Threshold A	ED/HD Adaptive Filter Threshold A	x	x	x	x	x	x	x	x	x	Threshold A	0x00
0x5C	ED/HD Adaptive Filter Threshold B	ED/HD Adaptive Filter Threshold B	x	x	x	x	x	x	x	x	x	Threshold B	0x00
0x5D	ED/HD Adaptive Filter Threshold C	ED/HD Adaptive Filter Threshold C	x	x	x	x	x	x	x	x	x	Threshold C	0x00

¹x = Logic 0 or Logic 1.

Table 27. Register 0x5E to Register 0x6E

SR7 to SR0	Register	Bit Description	Bit Number								Register Setting	Reset Value	
			7	6	5	4	3	2	1	0			
0x5E	ED/HD CGMS Type B Register 0	ED/HD CGMS Type B enable									0 1	Disabled Enabled	0x00
		ED/HD CGMS Type B CRC enable								0 1		Disabled Enabled	
		ED/HD CGMS Type B header bits	H5	H4	H3	H2	H1	H0				H5 to H0	
0x5F	ED/HD CGMS Type B Register 1	ED/HD CGMS Type B data bits	P7	P6	P5	P4	P3	P2	P1	P0	P7 to P0	0x00	
0x60	ED/HD CGMS Type B Register 2	ED/HD CGMS Type B data bits	P15	P14	P13	P12	P11	P10	P9	P8	P15 to P8	0x00	
0x61	ED/HD CGMS Type B Register 3	ED/HD CGMS Type B data bits	P23	P22	P21	P20	P19	P18	P17	P16	P23 to P16	0x00	
0x62	ED/HD CGMS Type B Register 4	ED/HD CGMS Type B data bits	P31	P30	P29	P28	P27	P26	P25	P24	P31 to P24	0x00	
0x63	ED/HD CGMS Type B Register 5	ED/HD CGMS Type B data bits	P39	P38	P37	P36	P35	P34	P33	P32	P39 to P32	0x00	
0x64	ED/HD CGMS Type B Register 6	ED/HD CGMS Type B data bits	P47	P46	P45	P44	P43	P42	P41	P40	P47 to P40	0x00	
0x65	ED/HD CGMS Type B Register 7	ED/HD CGMS Type B data bits	P55	P54	P53	P52	P51	P50	P49	P48	P55 to P48	0x00	
0x66	ED/HD CGMS Type B Register 8	ED/HD CGMS Type B data bits	P63	P62	P61	P60	P59	P58	P57	P56	P63 to P56	0x00	
0x67	ED/HD CGMS Type B Register 9	ED/HD CGMS Type B data bits	P71	P70	P69	P68	P67	P66	P65	P64	P71 to P64	0x00	
0x68	ED/HD CGMS Type B Register 10	ED/HD CGMS Type B data bits	P79	P78	P77	P76	P75	P74	P73	P72	P79 to P72	0x00	
0x69	ED/HD CGMS Type B Register 11	ED/HD CGMS Type B data bits	P87	P86	P85	P84	P83	P82	P81	P80	P87 to P80	0x00	
0x6A	ED/HD CGMS Type B Register 12	ED/HD CGMS Type B data bits	P95	P94	P93	P92	P91	P90	P89	P88	P95 to P88	0x00	
0x6B	ED/HD CGMS Type B Register 13	ED/HD CGMS Type B data bits	P103	P102	P101	P100	P99	P98	P97	P96	P103 to P96	0x00	
0x6C	ED/HD CGMS Type B Register 14	ED/HD CGMS Type B data bits	P111	P110	P109	P108	P107	P106	P105	P104	P111 to P104	0x00	
0x6D	ED/HD CGMS Type B Register 15	ED/HD CGMS Type B data bits	P119	P118	P117	P116	P115	P114	P113	P112	P119 to P112	0x00	
0x6E	ED/HD CGMS Type B Register 16	ED/HD CGMS Type B data bits	P127	P126	P125	P124	P123	P122	P121	P120	P127 to P120	0x00	

Table 28. Register 0x80 to Register 0x83

SR7 to SRO	Register	Bit Description	Bit Number								Register Setting	Reset Value		
			7	6	5	4	3	2	1	0				
0x80	SD Mode Register 1	SD standard								0	0	NTSC	0x10	
										0	1	PAL B/D/G/H/I		
										1	0	PAL M		
		SD luma filter				0	0	0				LPF NTSC		
						0	0	1				LPF PAL		
						0	1	0				Notch NTSC		
						0	1	1				Notch PAL		
						1	0	0				SSAF luma		
						1	0	1				Luma CIF		
						1	1	0				Luma QCIF		
						1	1	1				Reserved		
		SD chroma filter	0	0	0							1.3 MHz		
			0	0	1							0.65 MHz		
			0	1	0							1.0 MHz		
			0	1	1							2.0 MHz		
			1	0	0							Reserved		
			1	0	1							Chroma CIF		
			1	1	0							Chroma QCIF		
			1	1	1							3.0 MHz		
0x82	SD Mode Register 2	SD PrPb SSAF									0	Disabled	0x0B	
											1	Enabled		
		SD DAC Output 1									0			Refer to Table 37
											1			Refer to Table 37
		SD DAC Output 2								0				Refer to Table 37
										1				Refer to Table 37
		SD pedestal						0						Disabled
								1						Enabled
SD square pixel mode					0						Disabled			
					1						Enabled			
SD VCR FF/RW sync				0							Disabled			
				1							Enabled			
SD pixel data valid			0								Disabled			
			1								Enabled			
SD active video edge control		0									Disabled			
		1									Enabled			
0x83	SD Mode Register 3	SD pedestal on YPrPb output									0	No pedestal on YPrPb	0x04	
											1	7.5 IRE pedestal on YPrPb		
		SD Output Levels Y.									0			Y = 700 mV/300 mV
											1			Y = 714 mV/286 mV
		SD Output Levels PrPb						0	0					700 mV p-p (PAL), 1000 mV p-p (NTSC)
								0	1					700 mV p-p
						1	0				1000 mV p-p			
						1	1				648 mV p-p			
SD VBI open					0						Disabled			
					1						Enabled			
SD closed captioning field control		0	0								Closed captioning disabled			
		0	1								Closed captioning on odd field only			
		1	0								Closed captioning on even field only			
		1	1								Closed captioning on both fields			
Reserved		0									Reserved			

Table 29. Register 0x84 to Register 0x89

SR7 to SR0	Register	Bit Description	Bit Number							Register Setting	Reset Value		
			7	6	5	4	3	2	1			0	
0x84	SD Mode Register 4	Reserved									0	0x00	
		SD SFL/SCR/TR mode select						0	0				Disabled. SFL mode enabled.
		SD active video length					0						720 pixels. 710 (NTSC), 702 (PAL).
		SD chroma				0							Chroma enabled. Chroma disabled.
		SD burst			0								Enabled. Disabled.
		SD color bars		0									Disabled. Enabled.
		SD luma/chroma swap	0										DAC 2 = luma, DAC 3 = chroma . DAC 2 = chroma, DAC 3 = luma .
		1											
0x86	SD Mode Register 5	NTSC color subcarrier adjust (delay from the falling edge of the output HSYNC pulse to the start of color burst)							0	0		5.17 μ s. 5.31 μ s. 5.59 μ s (must be set for Macrovision compliance). Reserved.	0x02
		Reserved						0					
		SD EIA/CEA-861B synchronization compliance					0					Disabled. Enabled.	
		Reserved			0	0							
		SD horizontal/vertical counter mode ¹		0								Update field/line counter. Field/line counter free running.	
		SD RGB color swap	0									Normal. Color reversal enabled.	
				1									
0x87	SD Mode Register 6	SD luma and color scale control								0		Disabled. Enabled.	0x00
		SD luma scale saturation							0			Disabled. Enabled.	
		SD hue adjust						0				Disabled. Enabled.	
		SD brightness					0					Disabled. Enabled.	
		SD luma SSAF gain				0						Disabled. Enabled.	
		SD input standard autodetect			0							Disabled. Enabled.	
		Reserved		0								0 must be written to this bit.	
		SD RGB input enable	0									SD YCrCb input. SD RGB input.	
		1											

SR7 to SR0	Register	Bit Description	Bit Number							Register Setting	Reset Value	
			7	6	5	4	3	2	1			0
0x88	SD Mode Register 7	Reserved.								0		0x00
		SD noninterlaced mode							0 1	Disabled. Enabled.		
		SD double buffering						0 1		Disabled. Enabled.		
		SD input format				0 0 1 1	0 1 0 1			8-bit YCbCr input. 16-bit YCbCr input. 10-bit YCbCr input/16-/24-/30-bit RGB. 20-bit YCbCr input.		
		SD digital noise reduction			0 1					Disabled. Enabled.		
		SD gamma correction enable		0 1						Disabled. Enabled.		
		SD gamma correction curve select	0 1							Gamma Correction Curve A. Gamma Correction Curve B.		
0x89	SD Mode Register 8	SD undershoot limiter							0 0 1 1	0 1 0 1	Disabled. –11 IRE. –6 IRE. –1.5 IRE.	0x00
		Reserved						0		0 must be written to this bit.		
		SD black burst output on DAC luma					0 1			Disabled. Enabled.		
		SD chroma delay			0 0 1 1	0 1 0 1				Disabled. Four clock cycles. Eight clock cycles. Reserved.		
		Reserved	0 0							0 must be written to these bits.		

¹ When set to 0, the horizontal/vertical counters automatically wrap around at the end of the line/field/frame of the selected standard. When set to 1, the horizontal/vertical counters are free running and wrap around when external sync signals indicate to do so.

Table 30. Register 0x8A to Register 0x98

SR7 to SR0	Register	Bit Description	Bit Number ¹							Register Setting	Reset Value	
			7	6	5	4	3	2	1			0
0x8A	SD Timing Register 0	SD slave/master mode								0 1	Slave mode. Master mode.	0x08
		SD timing mode							0 0 1 1	0 1 0 1	Mode 0. Mode 1. Mode 2. Mode 3.	
		Reserved						1				
		SD luma delay			0 0 1 1	0 1 0 1					No delay. Two clock cycles. Four clock cycles. Six clock cycles.	
		SD minimum luma value		0 1							–40 IRE. –7.5 IRE.	
		SD timing reset	0 1								Normal operation. Freezes the counters; this bit must be set back to zero in order to reset the counters and resume operation.	

SR7 to SRO	Register	Bit Description	Bit Number ¹								Register Setting	Reset Value
			7	6	5	4	3	2	1	0		
0x8B	SD Timing Register 1 (applicable in master modes only, that is, Subaddress 0x8A, Bit 0 = 1)	SD HSYNC width							0	0	t _a = one clock cycle.	0x00
								0	1	t _a = four clock cycles.		
								1	0	t _a = 16 clock cycles.		
								1	1	t _a = 128 clock cycles.		
		SD HSYNC to VSYNC delay					0	0	t _b = 0 clock cycles.			
					0	1	t _b = four clock cycles.					
					1	0	t _b = eight clock cycles.					
					1	1	t _b = 18 clock cycles.					
		SD HSYNC to VSYNC rising edge delay (Mode 1 only)			X ²	0	t _c = t _b .					
				X ²	1		t _c = t _b + 32 μs					
		SD VSYNC width (Mode 2 only)			0	0	One clock cycle.					
				0	1		Four clock cycles.					
				1	0		16 clock cycles.					
				1	1		128 clock cycles.					
		SD HSYNC to pixel data adjust	0	0					0 clock cycles.			
			0	1					One clock cycle			
			1	0					Two clock cycles.			
			1	1					Three clock cycles.			
0x8C	SD F _{sc} Register 0 ³	Subcarrier Frequency Bits[7:0]	x	x	x	x	x	x	x	x	Subcarrier Frequency Bits[7:0].	0x1F
0x8D	SD F _{sc} Register 1 ³	Subcarrier Frequency Bits[15:8]	x	x	x	x	x	x	x	x	Subcarrier Frequency Bits[15:8].	0x7C
0x8E	SD F _{sc} Register 2 ³	Subcarrier Frequency Bits[23:16]	x	x	x	x	x	x	x	x	Subcarrier Frequency Bits[23:16].	0xF0
0x8F	SD F _{sc} Register 3 ³	Subcarrier Frequency Bits[31:24]	x	x	x	x	x	x	x	x	Subcarrier frequency Bits[31:24].	0x21
0x90	SD F _{sc} phase	Subcarrier Phase Bits[9:2]	x	x	x	x	x	x	x	x	Subcarrier Phase Bits[9:2].	0x00
0x91	SD closed captioning	Extended data on even fields	x	x	x	x	x	x	x	x	Extended Data Bits[7:0].	0x00
0x92	SD closed captioning	Extended data on even fields	x	x	x	x	x	x	x	x	Extended Data Bits[15:8].	0x00
0x93	SD closed captioning	Data on odd fields	x	x	x	x	x	x	x	x	Data Bits[7:0].	0x00
0x94	SD closed captioning	Data on odd fields	x	x	x	x	x	x	x	x	Data Bits[15:8].	0x00
0x95	SD Pedestal Register 0	Pedestal on odd fields	17	16	15	14	13	12	11	10	Setting any of these bits to 1 disables the pedestal on the line number indicated by the bit settings.	0x00
0x96	SD Pedestal Register 1	Pedestal on odd fields	25	24	23	22	21	20	19	18		0x00
0x97	SD Pedestal Register 2	Pedestal on even fields	17	16	15	14	13	12	11	10		0x00
0x98	SD Pedestal Register 3	Pedestal on even fields	25	24	23	22	21	20	19	18		0x00

¹ x = Logic 0 or Logic 1.

² X = don't care.

³ SD subcarrier frequency registers default to NTSC subcarrier frequency values.

Table 31. Register 0x99 to Register 0xA5

SR7 to SR0	Register	Bit Description	Bit Number ¹							Register Setting	Reset Value	
			7	6	5	4	3	2	1			0
0x99	SD CGMS/WSS 0	SD CGMS data					x	x	x	x	CGMS Data Bits[C19:C16]	0x00
		SD CGMS CRC				0 1					Disabled Enabled	
		SD CGMS on odd fields			0 1						Disabled Enabled	
		SD CGMS on even fields		0 1							Disabled Enabled	
		SD WSS	0 1								Disabled Enabled	
0x9A	SD CGMS/WSS 1	SD CGMS/WSS data			x	x	x	x	x	x	CGMS Data Bits[C13:C8] or WSS Data Bits[W13:W8]	0x00
		SD CGMS data	x	x							CGMS Data Bits[C15:C14]	
0x9B	SD CGMS/WSS 2	SD CGMS/WSS data	x	x	x	x	x	x	x	x	CGMS Data Bits[C7:C0] or WSS Data Bits[W7:W0]	0x00
0x9C	SD scale LSB	LSBs for SD Y scale value							x	x	SD Y Scale Bits[1:0]	0x00
		LSBs for SD Cb scale value					x	x			SD Cb Scale Bits[1:0]	
		LSBs for SD Cr scale value			x	x					SD Cr Scale Bits[1:0]	
		LSBs for SD F _{sc} phase	x	x							Subcarrier Phase Bits[1:0]	
0x9D	SD Y scale	SD Y scale value	x	x	x	x	x	x	x	SD Y Scale Bits[9:2]	0x00	
0x9E	SD Cb scale	SD Cb scale value	x	x	x	x	x	x	x	SD Cb Scale Bits[9:2]	0x00	
0x9F	SD Cr scale	SD Cr scale value	x	x	x	x	x	x	x	SD Cr Scale Bits[9:2]	0x00	
0xA0	SD hue adjust	SD hue adjust value	x	x	x	x	x	x	x	SD Hue Adjust Bits[7:0]	0x00	
0xA1	SD brightness/WSS	SD brightness value		x	x	x	x	x	x	x	SD Brightness Bits[6:0]	0x00
		SD blank WSS data	0 1								Disabled Enabled	
0xA2	SD luma SSAF	SD luma SSAF gain/attenuation (only applicable if Subaddress 0x87, Bit 4 = 1)					0 ... 0 ... 1	0 ... 1 ... 1	0 ... 1 ... 0	0 ... 0 ... 0	-4 dB ... 0 dB ... +4 dB	0x00
		Reserved	0	0	0	0						

SR7 to SR0	Register	Bit Description	Bit Number ¹								Register Setting	Reset Value
			7	6	5	4	3	2	1	0		
0xA3	SD DNR 0	Coring gain border (in DNR mode, the values in brackets apply)					0	0	0	0	No gain	0x00
						0	0	0	1	+1/16 [-1/8]		
						0	0	1	0	+2/16 [-2/8]		
						0	0	1	1	+3/16 [-3/8]		
						0	1	0	0	+4/16 [-4/8]		
						0	1	0	1	+5/16 [-5/8]		
						0	1	1	0	+6/16 [-6/8]		
						0	1	1	1	+7/16 [-7/8]		
						1	0	0	0	+8/16 [-1]		
0xA4	SD DNR 1	DNR threshold			0	0	0	0	0	0	0	0x00
					0	0	0	0	0	1	1	
						
					1	1	1	1	1	0	62	
					1	1	1	1	1	1	63	
		Border area		0							Two pixels	
				1							Four pixels	
		Block size control	0								Eight pixels	
			1								16 pixels	
0xA5	SD DNR 2	DNR input select						0	0	1	Filter A	0x00
								0	1	0	Filter B	
								0	1	1	Filter C	
								1	0	0	Filter D	
		DNR mode					0				DNR mode	
							1				DNR sharpness mode	
		DNR block offset	0	0	0	0					0 pixel offset	
			0	0	0	1					One pixel offset	
			
			1	1	1	0					14 pixel offset	
			1	1	1	1					15 pixel offset	

¹x = Logic 0 or Logic 1.

Table 32. Register 0xA6 to Register 0xBB

SR7 to SR0	Register	Bit Description	Bit Number ¹								Register Setting	Reset Value		
			7	6	5	4	3	2	1	0				
0xA6	SD Gamma A0	SD Gamma Curve A (Point 24)	x	x	x	x	x	x	x	x	A0	0x00		
0xA7	SD Gamma A1	SD Gamma Curve A (Point 32)	x	x	x	x	x	x	x	x	A1	0x00		
0xA8	SD Gamma A2	SD Gamma Curve A (Point 48)	x	x	x	x	x	x	x	x	A2	0x00		
0xA9	SD Gamma A3	SD Gamma Curve A (Point 64)	x	x	x	x	x	x	x	x	A3	0x00		
0xAA	SD Gamma A4	SD Gamma Curve A (Point 80)	x	x	x	x	x	x	x	x	A4	0x00		
0xAB	SD Gamma A5	SD Gamma Curve A (Point 96)	x	x	x	x	x	x	x	x	A5	0x00		
0xAC	SD Gamma A6	SD Gamma Curve A (Point 128)	x	x	x	x	x	x	x	x	A6	0x00		
0xAD	SD Gamma A7	SD Gamma Curve A (Point 160)	x	x	x	x	x	x	x	x	A7	0x00		
0xAE	SD Gamma A8	SD Gamma Curve A (Point 192)	x	x	x	x	x	x	x	x	A8	0x00		
0xAF	SD Gamma A9	SD Gamma Curve A (Point 224)	x	x	x	x	x	x	x	x	A9	0x00		
0xB0	SD Gamma B0	SD Gamma Curve B (Point 24)	x	x	x	x	x	x	x	x	B0	0x00		
0xB1	SD Gamma B1	SD Gamma Curve B (Point 32)	x	x	x	x	x	x	x	x	B1	0x00		
0xB2	SD Gamma B2	SD Gamma Curve B (Point 48)	x	x	x	x	x	x	x	x	B2	0x00		
0xB3	SD Gamma B3	SD Gamma Curve B (Point 64)	x	x	x	x	x	x	x	x	B3	0x00		
0xB4	SD Gamma B4	SD Gamma Curve B (Point 80)	x	x	x	x	x	x	x	x	B4	0x00		
0xB5	SD Gamma B5	SD Gamma Curve B (Point 96)	x	x	x	x	x	x	x	x	B5	0x00		
0xB6	SD Gamma B6	SD Gamma Curve B (Point 128)	x	x	x	x	x	x	x	x	B6	0x00		
0xB7	SD Gamma B7	SD Gamma Curve B (Point 160)	x	x	x	x	x	x	x	x	B7	0x00		
0xB8	SD Gamma B8	SD Gamma Curve B (Point 192)	x	x	x	x	x	x	x	x	B8	0x00		
0xB9	SD Gamma B9	SD Gamma Curve B (Point 224)	x	x	x	x	x	x	x	x	B9	0x00		
0xBA	SD brightness detect	SD brightness value	x	x	x	x	x	x	x	x	Read only	0xXX		
0xBB	Field count	Field count							x	x	x	Read only	0x0X	
		Reserved			0	0	0					Reserved		
		Encoder version code	0	0									Read only; first encoder version ²	
			0	1									Read only; second encoder version	

¹ x = Logic 0 or Logic 1.² See the HD Interlace External P_HSYNC and P_VSYNC Considerations section for information about the first encoder revision.

Table 33. Register 0xBD to Register 0xC8

SR7 to SR0	Register	Bit Description	Bit Number ¹								Register Setting	Reset Value
			7	6	5	4	3	2	1	0		
0xBD	SD CSC Matrix 1	SD CSC matrix coefficient	x	x	x	x	x	x	x	x	Bits[7:0] for a1	0x42
0xBE	SD CSC Matrix 2	SD CSC matrix coefficient	x	x	x	x	x	x	x	x	Bits[7:0] for a2	0x81
0xBF	SD CSC Matrix 3	SD CSC matrix coefficient	x	x	x	x	x	x	x	x	Bits[7:0] for a3	0x19
0xC0	SD CSC Matrix 4	SD CSC matrix coefficient	x	x	x	x	x	x	x	x	Bits[7:0] for a4	0x10
0xC1	SD CSC Matrix 5	SD CSC matrix coefficient	x	x	x	x	x	x	x	x	Bits[7:0] for b1	0x70
0xC2	SD CSC Matrix 6	SD CSC matrix coefficient	x	x	x	x	x	x	x	x	Bits[7:0] for b2	0x5E
0xC3	SD CSC Matrix 7	SD CSC matrix coefficient	x	x	x	x	x	x	x	x	Bits[7:0] for b3	0x12
0xC4	SD CSC Matrix 8	SD CSC matrix coefficient	x	x	x	x	x	x	x	x	Bits[7:0] for b4	0x80
0xC5	SD CSC Matrix 9	SD CSC matrix coefficient	x	x	x	x	x	x	x	x	Bits[7:0] for c1	0x26
0xC6	SD CSC Matrix 10	SD CSC matrix coefficient	x	x	x	x	x	x	x	x	Bits[7:0] for c2	0x4A
0xC7	SD CSC Matrix 11	SD CSC matrix coefficient	x	x	x	x	x	x	x	x	Bits[7:0] for c3	0x70
0xC8	SD CSC Matrix 12	SD CSC matrix coefficient	x	x	x	x	x	x	x	x	Bits[7:0] for c4	0x80

¹ x = Logic 0 or Logic 1.

Table 34. Register 0xC9 to Register 0xCE

SR7 to SR0	Register	Bit Description	Bit Number							Register Setting	Reset Value	
			7	6	5	4	3	2	1			0
0xC9	Teletext control	Teletext enable								0 1	Disabled. Enabled.	0x00
		Teletext request mode							0 1	Line request signal. Bit request signal.		
		Teletext input pin select					0 0 1 1	0 1		S_VSYNC. P_VSYNC. C0. Reserved.		
		Reserved	0	0	0	0					Reserved.	
0xCA	Teletext request control	Teletext request falling edge position control					0 0 ...	0 0 ...	0 0 ...	0 1 ...	0 clock cycles. One clock cycle. ...	0x00
						1 1 ...	1 1	1 1	0 1 ...	14 clock cycles. 15 clock cycles.		
		Teletext request rising edge position control	0 0 ...	0 0 ...	0 0 ...	0 1 ...				0 clock cycles. One clock cycle. ...		
			1 1 ...	1 1 ...	1 1 ...	0 1 ...				14 clock cycles. 15 clock cycles.		
0xCB	TTX Line Enable 0	Teletext on odd fields	22	21	20	19	18	17	16	15	Setting any of these bits to 1 enables teletext on the line number indicated by the bit settings.	0x00
0xCC	TTX Line Enable 1	Teletext on odd fields	14	13	12	11	10	9	8	7		0x00
0xCD	TTX Line Enable 2	Teletext on even fields	22	21	20	19	18	17	16	15		0x00
0xCE	TTX Line Enable 3	Teletext on even fields	14	13	12	11	10	9	8	7		0x00

Table 35. Register 0xE0 to Register 0xF1

SR7 to SR0	Register ²	Bit Description	Bit Number ¹							Register Setting	Reset Value	
			7	6	5	4	3	2	1			0
0xE0	Macrovision	MV control bits	x	x	x	x	x	x	x	x		0x00
0xE1	Macrovision	MV control bits	x	x	x	x	x	x	x	x		0x00
0xE2	Macrovision	MV control bits	x	x	x	x	x	x	x	x		0x00
0xE3	Macrovision	MV control bits	x	x	x	x	x	x	x	x		0x00
0xE4	Macrovision	MV control bits	x	x	x	x	x	x	x	x		0x00
0xE5	Macrovision	MV control bits	x	x	x	x	x	x	x	x		0x00
0xE6	Macrovision	MV control bits	x	x	x	x	x	x	x	x		0x00
0xE7	Macrovision	MV control bits	x	x	x	x	x	x	x	x		0x00
0xE8	Macrovision	MV control bits	x	x	x	x	x	x	x	x		0x00
0xE9	Macrovision	MV control bits	x	x	x	x	x	x	x	x		0x00
0xEA	Macrovision	MV control bits	x	x	x	x	x	x	x	x		0x00
0xEB	Macrovision	MV control bits	x	x	x	x	x	x	x	x		0x00
0xEC	Macrovision	MV control bits	x	x	x	x	x	x	x	x		0x00
0xED	Macrovision	MV control bits	x	x	x	x	x	x	x	x		0x00
0xEE	Macrovision	MV control bits	x	x	x	x	x	x	x	x		0x00
0xEF	Macrovision	MV control bits	x	x	x	x	x	x	x	x		0x00
0xF0	Macrovision	MV control bits	x	x	x	x	x	x	x	x		0x00
0xF1	Macrovision	MV control bits	0	0	0	0	0	0	0	x	Bits[7:1] must be 0.	0x00

¹ x = Logic 0 or Logic 1.

² Macrovision registers are available on the ADV7340 only.

INPUT CONFIGURATION

The ADV7340/ADV7341 support a number of different input modes. The desired input mode is selected using Subaddress 0x01, Bits[6:4]. The ADV7340/ADV7341 default to standard definition only (SD only) on power-up. Table 36 provides an overview of all possible input configurations. Each input mode is described in detail in the following sections.

STANDARD DEFINITION ONLY

Subaddress 0x01, Bits[6:4] = 000

Standard definition (SD) YCrCb data can be input in 4:2:2 format. Standard definition (SD) RGB data can be input in 4:4:4 format. A 27 MHz clock signal must be provided on the CLKIN_A pin. Input synchronization signals are provided on the S_HSYNC and S_VSYNC pins.

8-/10-Bit 4:2:2 YCrCb Mode

Subaddress 0x87, Bit 7 = 0; Subaddress 0x88, Bit 3 = 0

In 8-/10-bit 4:2:2 YCrCb input mode, the interleaved pixel data is input on Pin S9 to Pin S2/S0 (or Pin Y9 to Pin Y2/Y0, depending on Subaddress 0x01, Bit 7), with Pin S0/Y0 being the LSB in 10-bit input mode. The ITU-R BT.601/656 input standard is supported. Embedded EAV/SAV timing codes are also supported.

16-/20-Bit 4:2:2 YCrCb Mode

Subaddress 0x87, Bit 7 = 0; Subaddress 0x88, Bit 3 = 1

In 16-/20-bit 4:2:2 YCrCb input mode, Y pixel data is input on Pin S9 to Pin S2/S0 (or Pin Y9 to Pin Y2/Y0, depending on

Subaddress 0x01, Bit 7); Pin S0/Y0 is the LSB in 20-bit input mode.

The CrCb pixel data is input on Pin Y9 to Pin Y2/Y0 (or Pin C9 to Pin C2/C0, depending on Subaddress 0x01, Bit 7), with Pin Y0/C0 being the LSB in 20-bit input mode.

Embedded EAV/SAV timing codes are not supported; therefore, an external synchronization is needed in this mode.

24-/30-Bit 4:4:4 RGB Mode

Subaddress 0x87, Bit 7 = 1

In 24-/30-bit 4:4:4 RGB input mode, the red pixel data is input on Pin S9 to Pin S2/S0, the green pixel data is input on Pin Y9 to Pin Y2/Y0, and the blue pixel data is input on Pin C9 to Pin C2/C0. The S0, Y0, and C0 pins are the respective bus LSBs in 30-bit input mode.

Embedded EAV/SAV timing codes are not supported. Also, master timing mode is not supported for SD RGB input mode, therefore, external synchronization must be used.

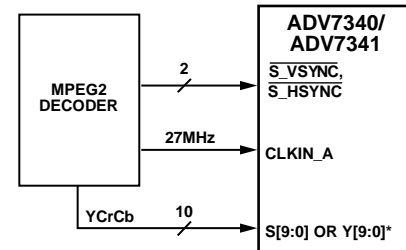

*SELECTED BY SUBADDRESS 0x01, BIT 7.

Figure 51. SD Only Example Application

063398-051

Table 36. Input Configuration

Input Mode ¹	S										Y										C									
	9	8	7	6	5	4	3	2	1	0	9	8	7	6	5	4	3	2	1	0	9	8	7	6	5	4	3	2	1	0
000 SD only 8-/10-bit YCrCb ^{2,3} 16-/20-bit YCrCb ^{2,3,4} 8-/10-bit YCrCb ^{2,3} 16-/20-bit YCrCb ^{2,3,4} 24-/30-bit RGB ⁴	Y/C/S bus swap (Subaddress 0x01[7]) = 0																													
	YCrCb																													
	Y										CrCb																			
	Y/C/S bus swap (Subaddress 0x01[7]) = 1																													
											YCrCb																			
											Y										CrCb									
SD RGB input enable (Subaddress 0x87[7]) = 1																														
R										G										B										
001 ED/HD-SDR only ^{3,5,6,7} 16-/20-bit YCrCb 24-/30-bit YCrCb 24-/30-bit RGB ⁴	ED/HD RGB input enable (Subaddress 0x35[1]) = 0																													
											Y										CrCb									
	Cr										Y										Cb									
	ED/HD RGB input enable (Subaddress 0x35[1]) = 1																													
R										G										B										
010 ED/HD-DDR only (8-/10-bit) ^{3,6,7}											YCrCb																			
011 SD, ED/HD-SDR (24-/30-bit) ^{3,6,7,8}	YCrCb (SD)										Y (ED/HD)										CrCb (ED/HD)									
100 SD, ED/HD-DDR (16-/20-bit) ^{3,6,7,8}	YCrCb (SD)										YCrCb (ED/HD)																			
111 ED only (54 MHz) (8-/10-bit) ^{3,6,7}											YCrCb																			

¹ The input mode is determined by Subaddress 0x01, Bits[6:4].

² In SD only (YCrCb) mode, the format of the input data is determined by Subaddress 0x88, Bits[4:3]. See Table 29 for more information.

³ For 8-/16-/24-bit inputs, only the eight most significant bits (MSBs) of each applicable input bus are used.

⁴ External synchronization signals must be used in this input mode. Embedded EAV/SAV timing codes are not supported.

⁵ In ED/HD-SDR only (YCrCb) mode, the format of the input data is determined by Subaddress 0x33, Bit 6. See Table 22 for more information.

⁶ ED = enhanced definition = 525p and 625p.

⁷ The bus width of the ED/HD input data is determined by Subaddress 0x33, Bit 2 (0 = 8-bit input, 1 = 10-bit input). See Table 22 for more information.

⁸ The bus width of the SD input data is determined by Subaddress 0x88, Bits[4:3] (00 = 8-bit, 01 = 16-bit, 10 = 10-bit, 11 = 20-bit). See Table 29 for more information.

ENHANCED DEFINITION/HIGH DEFINITION ONLY

Subaddress 0x01, Bits[6:4] = 001 or 010

Enhanced definition (ED) or high definition (HD) YCrCb data can be input in either 4:2:2 or 4:4:4 format. If desired, dual data rate (DDR) pixel data inputs can be employed (4:2:2 format only).

Enhanced definition (ED) or high definition (HD) RGB data can be input in 4:4:4 format (single data rate only).

The clock signal must be provided on the CLKIN_A pin. Input synchronization signals are provided on the P_HSYNC, P_VSYNC, and P_BLANK pins.

16-/20-Bit 4:2:2 YCrCb Mode (SDR)

Subaddress 0x35, Bit 1 = 0; Subaddress 0x33, Bit 6 = 1

In 16-/20-bit 4:2:2 YCrCb input mode, the Y pixel data is input on Pin Y9 to Pin Y2/Y0, with Pin Y0 being the LSB in 20-bit input mode.

The CrCb pixel data is input on Pin C9 to Pin C2/C0, with Pin C0 being the LSB in 20-bit input mode.

8-/10-Bit 4:2:2 YCrCb Mode (DDR)

Subaddress 0x35, Bit 1 = 0; Subaddress 0x33, Bit 6 = 1

In 8-/10-bit DDR 4:2:2 YCrCb input mode, the Y pixel data is input on Pin Y9 to Pin Y2/Y0 on either the rising or falling edge of CLKIN_A. Pin Y0 is the LSB in 10-bit input mode.

The CrCb pixel data is also input on Pin Y9 to Pin Y2/Y0 on the opposite edge of CLKIN_A. Pin Y0 is the LSB in 10-bit input mode.

Whether the Y data is clocked in on the rising or falling edge of CLKIN_A is determined by Subaddress 0x01, Bits[2:1] (see Figure 52 and Figure 53).

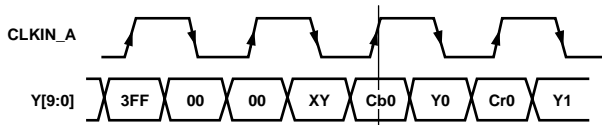

NOTES
1. SUBADDRESS 0x01 [2:1] SHOULD BE SET TO 00 IN THIS CASE.

Figure 52. ED/HD-DDR Input Sequence (EAV/SAV)—Option A

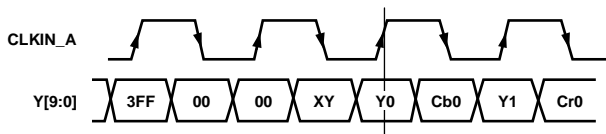

NOTES
1. SUBADDRESS 0x01 [2:1] SHOULD BE SET TO 11 IN THIS CASE.

Figure 53. ED/HD-DDR Input Sequence (EAV/SAV)—Option B

24-/30-Bit 4:4:4 YCrCb Mode

Subaddress 0x35, Bit 1 = 0; Subaddress 0x33, Bit 6 = 0

In 24-/30-bit 4:4:4 YCrCb input mode, the Y pixel data is input on Pin Y9 to Pin Y2/Y0, with Pin Y0 being the LSB in 30-bit input mode.

The Cr pixel data is input on Pin S9 to Pin S2/S0, with Pin S0 being the LSB in 30-bit input mode. The Cb pixel data is input on Pin C9 to Pin C2/C0 (Pin C0 being the LSB in 30-bit input mode).

24-/30-Bit 4:4:4 RGB Mode

Subaddress 0x35, Bit 1 = 1

In 24-/30-bit 4:4:4 RGB input mode, the red pixel data is input on Pin S9 to Pin S2/S0, the green pixel data is input on Pin Y9 to Pin Y2/Y0, and the blue pixel data is input on Pin C9 to Pin C2/C0. The S0, Y0, and C0 pins are the respective bus LSBs in 30-bit input mode.

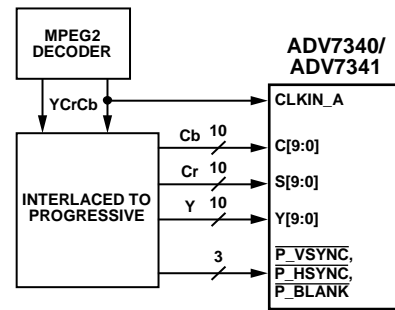

Figure 54. ED/HD Only Example Application

SIMULTANEOUS STANDARD DEFINITION AND ENHANCED DEFINITION/HIGH DEFINITION

Subaddress 0x01, Bits[6:4] = 011 or 100

The ADV7340/ADV7341 are able to simultaneously process SD 4:2:2 YCrCb data and ED/HD 4:2:2 YCrCb data. The 27 MHz SD clock signal must be provided on the CLKIN_A pin. The ED/HD clock signal must be provided on the CLKIN_B pin. SD input synchronization signals are provided on the S_HSYNC and S_VSYNC pins. ED/HD input synchronization signals are provided on the P_HSYNC, P_VSYNC, and P_BLANK pins.

SD 8-/10-Bit 4:2:2 YCrCb and ED/HD-SDR 16-/20-Bit 4:2:2 YCrCb

The SD 8-/10-bit 4:2:2 YCrCb pixel data is input on Pin S9 to Pin S2/S0, with Pin S0 being the LSB in 10-bit input mode.

The ED/HD 16-/20-bit 4:2:2 Y pixel data is input on Pin Y9 to Pin Y2/Y0, with Pin Y0 being the LSB in 20-bit input mode.

The ED/HD 16-/20-bit 4:2:2 CrCb pixel data is input on Pin C9 to Pin C2/C0, with Pin C0 being the LSB in 20-bit input mode.

SD 8-/10-Bit 4:2:2 YCrCb and ED/HD-DDR 8-/10-Bit 4:2:2 YCrCb

The SD 8-/10-bit 4:2:2 YCrCb pixel data is input on Pin S9 to Pin S2/S0, with Pin S0 being the LSB in 10-bit input mode.

The ED/HD-DDR 8-/10-bit 4:2:2 Y pixel data is input on Pin Y9 to Pin Y2/Y0 upon the rising or falling edge of CLKIN_B. Pin Y0 is the LSB in 10-bit input mode.

The ED/HD-DDR 8-/10-bit 4:2:2 CrCb pixel data is also input on Pin Y9 to Pin Y2/Y0 on the opposite edge of CLKIN_B. Pin Y0 is the LSB in 10-bit input mode.

Whether the ED/HD Y data is clocked in on the rising or falling edge of CLKIN_B is determined by Subaddress 0x01, Bits[2:1] (see the input sequence shown in Figure 52 and Figure 53).

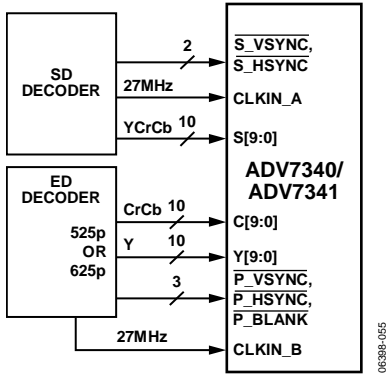

Figure 55. Simultaneous SD and ED Example Application

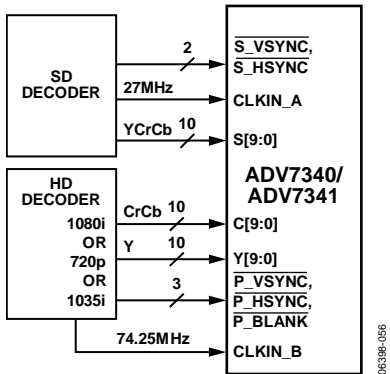

Figure 56. Simultaneous SD and HD Example Application

ENHANCED DEFINITION ONLY (AT 54 MHz)

Subaddress 0x01, Bits[6:4] = 111

Enhanced definition (ED) YCrCb data can be input in an interleaved 4:2:2 format on an 8-/10-bit bus at a rate of 54 MHz.

A 54 MHz clock signal must be provided on the CLKIN_A pin. Input synchronization signals are provided on the P_VSYNC, P_HSYNC, and P_BLANK pins.

The interleaved pixel data is input on Pin Y9 to Pin Y2/Y0, with Pin Y0 being the LSB in 10-bit input mode.

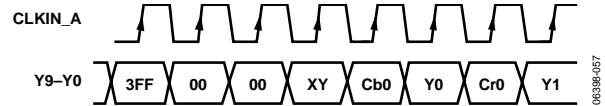

Figure 57. ED Only (at 54 MHz) Input Sequence (EAV/SAV)

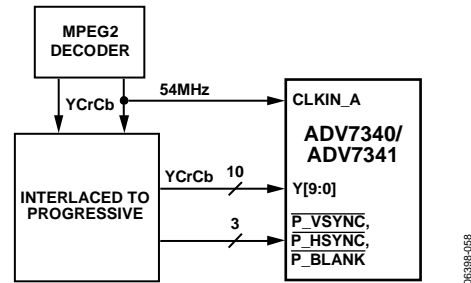

Figure 58. ED Only (at 54 MHz) Example Application

OUTPUT CONFIGURATION

The ADV7340/ADV7341 support a number of different output configurations. Table 37 to Table 40 list all possible output configurations.

Table 37. SD Only Output Configurations

RGB/YPrPb Output Select ¹ (Subaddress 0x02, Bit 5)	SD DAC Output 2 (Subaddress 0x82, Bit 2)	SD DAC Output 1 (Subaddress 0x82, Bit 1)	SD Luma/Chroma Swap (Subaddress 0x84, Bit 7)	DAC 1	DAC 2	DAC 3	DAC 4	DAC 5	DAC 6
0	0	0	0	G	B	R	CVBS	Luma	Chroma
0	0	0	1	G	B	R	CVBS	Chroma	Luma
0	0	1	0	CVBS	Luma	Chroma	G	B	R
0	0	1	1	CVBS	Chroma	Luma	G	B	R
0	1	0	0	CVBS	B	R	G	Luma	Chroma
0	1	0	1	CVBS	B	R	G	Chroma	Luma
0	1	1	0	G	Luma	Chroma	CVBS	B	R
0	1	1	1	G	Chroma	Luma	CVBS	B	R
1	0	0	0	Y	Pb	Pr	CVBS	Luma	Chroma
1	0	0	1	Y	Pb	Pr	CVBS	Chroma	Luma
1	0	1	0	CVBS	Luma	Chroma	Y	Pb	Pr
1	0	1	1	CVBS	Chroma	Luma	Y	Pb	Pr
1	1	0	0	CVBS	Pb	Pr	Y	Luma	Chroma
1	1	0	1	CVBS	Pb	Pr	Y	Chroma	Luma
1	1	1	0	Y	Luma	Chroma	CVBS	Pb	Pr
1	1	1	1	Y	Chroma	Luma	CVBS	Pb	Pr

¹ If SD RGB output is selected, a color reversal is possible using Subaddress 0x86, Bit 7.

Table 38. ED/HD Only Output Configurations

RGB/YPrPb Output Select (Subaddress 0x02, Bit 5)	ED/HD Color DAC Swap (Subaddress 0x35, Bit 3)	DAC 1	DAC 2	DAC 3	DAC 4	DAC 5	DAC 6
0	0	G	B	R	N/A	N/A	N/A
0	1	G	R	B	N/A	N/A	N/A
1	0	Y	Pb	Pr	N/A	N/A	N/A
1	1	Y	Pr	Pb	N/A	N/A	N/A

Table 39. Simultaneous SD and ED/HD Output Configurations

RGB/YPrPb Output Select (Subaddress 0x02, Bit 5)	ED/HD Color DAC Swap (Subaddress 0x35, Bit 3)	SD Luma/Chroma Swap (Subaddress 0x84, Bit 7)	DAC 1 (ED/HD)	DAC 2 (ED/HD)	DAC 3 (ED/HD)	DAC 4 (SD)	DAC 5 (SD)	DAC 6 (SD)
0	0	0	G	B	R	CVBS	Luma	Chroma
0	0	1	G	B	R	CVBS	Chroma	Luma
0	1	0	G	R	B	CVBS	Luma	Chroma
0	1	1	G	R	B	CVBS	Chroma	Luma
1	0	0	Y	Pb	Pr	CVBS	Luma	Chroma
1	0	1	Y	Pb	Pr	CVBS	Chroma	Luma
1	1	0	Y	Pr	Pb	CVBS	Luma	Chroma
1	1	1	Y	Pr	Pb	CVBS	Chroma	Luma

Table 40. ED Only (at 54 MHz) Output Configurations

RGB/YPrPb Output Select (Subaddress 0x02, Bit 5)	ED/HD Color DAC Swap (Subaddress 0x35, Bit 3)	DAC 1	DAC 2	DAC 3	DAC 4	DAC 5	DAC 6
0	0	G	B	R	N/A	N/A	N/A
0	1	G	R	B	N/A	N/A	N/A
1	0	Y	Pb	Pr	N/A	N/A	N/A
1	1	Y	Pr	Pb	N/A	N/A	N/A

DESIGN FEATURES

OUTPUT OVERSAMPLING

The ADV7340/ADV7341 include two on-chip phase-locked loops (PLLs) that allow for oversampling of SD, ED, and HD video data. Table 41 shows the various oversampling rates supported in the ADV7340/ADV7341.

SD Only, ED Only, and HD Only Modes

PLL 1 is used in SD only, ED only, and HD only modes. PLL 2 is unused in these modes. PLL 1 is disabled by default and can be enabled using Subaddress 0x00, Bit 1 = 0.

SD and ED/HD Simultaneous Modes

Both PLL 1 and PLL 2 are used in simultaneous modes. The use of two PLLs allows for independent oversampling of SD and ED/HD video. PLL 1 is used to oversample SD video data, and PLL 2 is used to oversample ED/HD video data. In simultaneous modes, PLL 2 is always enabled. PLL 1 is disabled by default and can be enabled using Subaddress 0x00, Bit 1 = 0.

External Sync Polarity

For SD and ED/HD modes, the ADV7340/ADV7341 typically expect HS and VS to be low during their respective blanking periods. When the CEA861 compliance bit (Subaddress 0x39, Bit 5 for ED/HD modes and Subaddress 0x86, Bit 3 for SD modes) is enabled, however, the part expects the HS or VS to be active low or high depending on the input format selected (Subaddress 0x30, Bits [7:3]).

If a different polarity other than the default is needed for ED/HD modes, Subaddress 0x3A, Bits [2:0] can be used to

individually invert $\overline{P_HSYNC}$, $\overline{P_VSYNC}$, or $\overline{P_BLANK}$ regardless of whether or not CEA-861-B mode is enabled. It is not possible to invert $\overline{S_HSYNC}$ or $\overline{S_VSYNC}$.

HD INTERLACE EXTERNAL $\overline{P_HSYNC}$ AND $\overline{P_VSYNC}$ CONSIDERATIONS

If the encoder revision code (Subaddress 0xBB, Bits[7:6]) = 01 or higher, the user should set Subaddress 0x02, Bit 1 to high to ensure exactly correct timing in HD interlace modes when using the $\overline{P_HSYNC}$ and $\overline{P_VSYNC}$ synchronization signals. If this bit is set to low, the first active pixel on each line is masked. Also, Pr and Pb outputs are swapped when using the YCrCb 4:2:2 input format. Setting Subaddress 0x02, Bit 1 to low causes the encoder to behave in the same way as the first version of silicon (that is, this setting is backward compatible).

If the encoder revision code (Subaddress 0xBB, Bits[7:6]) = 00, the setting of Subaddress 0x02, Bit 1 has no effect. In this version of the encoder, the first active pixel is masked. Also, Pr and Pb outputs are swapped when using the YCrCb 4:2:2 input format. To avoid these limitations, use the newer revision of silicon or use a different type of synchronization.

These considerations apply only to the HD interlace modes with external $\overline{P_HSYNC}$ and $\overline{P_VSYNC}$ synchronization (EAV/SAV mode is not affected and always has exactly correct timing). There is no negative effect in setting Subaddress 0x02, Bit 0 to high, and this bit can remain high for all the other video standards.

Table 41. Output Oversampling Modes and Rates

Input Mode	Subaddress 0x01 Bits[6:4]	PLL and Oversampling Control Subaddress 0x00, Bit 1	Oversampling Mode and Rate
000	SD only	1	SD (2×)
000	SD only	0	SD (16×)
001/010	ED only	1	ED (1×)
001/010	ED only	0	ED (8×)
001/010	HD only	1	HD (1×)
001/010	HD only	0	HD (4×)
011/100	SD and ED	1	SD (2×) and ED (8×)
011/100	SD and ED	0	SD (16×) and ED (8×)
011/100	SD and HD	1	SD (2×) and HD (4×)
011/100	SD and HD	0	SD (16×) and HD (4×)
111	ED only (at 54 MHz)	1	ED only (at 54 MHz) (1×)
111	ED only (at 54 MHz)	0	ED only (at 54 MHz) (8×)

ED/HD TIMING RESET

Subaddress 0x34, Bit 0

An ED/HD timing reset is achieved by toggling the ED/HD timing reset control bit (Subaddress 0x34, Bit 0) from 0 to 1. In this state, the horizontal and vertical counters remain reset. When this bit is set back to 0, the internal counters resume counting. This timing reset applies to the ED/HD timing counters only.

SD SUBCARRIER FREQUENCY LOCK

Subcarrier Frequency Lock (SFL) Mode

In this mode (Subaddress 0x84, Bits[2:1] = 11), the ADV7340/ADV7341 can be used to lock to an external video source. The SFL mode allows the ADV7340/ADV7341 to automatically alter the subcarrier frequency to compensate for line length variations. When the part is connected to a device such as an ADV7403 video decoder (see Figure 59) that outputs a digital data stream in the SFL format, the part automatically changes to the compensated subcarrier frequency on a line-by-line basis. This digital data stream is 67 bits wide, and the subcarrier is contained in Bit 0 to Bit 21. Each bit is two clock cycles long.

SD VCR FF/RW SYNC

Subaddress 0x82, Bit 5

In DVD record applications where the encoder is used with a decoder, the VCR FF/RW sync control bit can be used for non-standard input video, that is, in fast forward or rewind modes.

In fast forward mode, the sync information at the start of a new field in the incoming video usually occurs before the correct number of lines/fields is reached. In rewind mode, this sync signal usually occurs after the total number of lines/fields is

reached. Conventionally, this means that the output video has corrupted field signals because one signal is generated by the incoming video and another is generated when the internal line/field counters reach the end of a field.

When the VCR FF/RW sync control is enabled (Subaddress 0x82, Bit 5), the line/field counters are updated according to the incoming VSYNC signal and when the analog output matches the incoming VSYNC signal. This control is available in all slave-timing modes except slave Mode 0.

VERTICAL BLANKING INTERVAL

Subaddress 0x31, Bit 4; Subaddress 0x83, Bit 4

The ADV7340/ADV7341 are able to accept input data that contains VBI data (such as CGMS, WSS, VITS) in SD, ED, and HD modes.

If VBI is disabled (Subaddress 0x31, Bit 4 for ED/HD; Subaddress 0x83, Bit 4 for SD), VBI data is not present at the output and the entire VBI is blanked. These control bits are valid in all master and slave timing modes.

For the SMPTE 293M (525p) standard, VBI data can be inserted on Line 13 to Line 42 of each frame or on Line 6 to Line 43 for the ITU-R BT.1358 (625p) standard. VBI data can be present on Line 10 to Line 20 for NTSC and on Line 7 to Line 22 for PAL.

In SD Timing Mode 0 (slave option), if VBI is enabled, the blanking bit in the EAV/SAV code is overwritten. It is possible to use VBI in this timing mode as well.

If CGMS is enabled and VBI is disabled, the CGMS data is, nevertheless, available at the output.

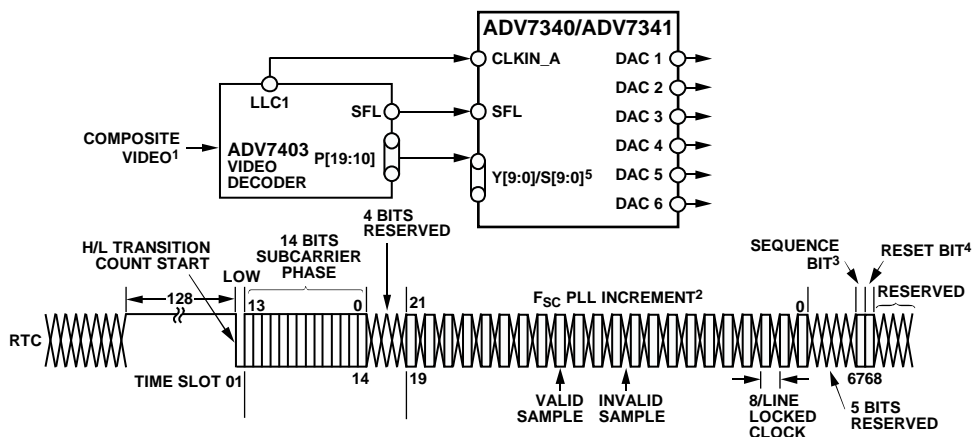

¹FOR EXAMPLE, VCR OR CABLE.
²F_{SC} PLL INCREMENT IS 22 BITS LONG. VALUE LOADED INTO ADV7340/ADV7341 F_{SC} DDS REGISTER IS F_{SC} PLL INCREMENTS BITS[21:0] PLUS BITS[0:9] OF SUBCARRIER FREQUENCY REGISTERS.
³SEQUENCE BIT
 PAL: 0 = LINE NORMAL, 1 = LINE INVERTED
 NTSC: 0 = NO CHANGE
⁴RESET ADV7340/ADV7341 DDS.
⁵SELECTED BY SUBADDRESS 0x01, BIT 7.

Figure 59. SD Subcarrier Frequency Lock Timing and Connections Diagram (Subaddress 0x84, Bits[2:1] = 11)

06398-083

SD SUBCARRIER FREQUENCY CONTROL

Subaddress 0x8C to Subaddress 0x8F

The ADV7340/ADV7341 is able to generate the color subcarrier used in CVBS and S-Video (Y-C) outputs from the input pixel clock. Four 8-bit registers are used to set up the subcarrier frequency. The value of these registers is calculated using

$$\text{Subcarrier Frequency Register} = \frac{\text{Number of subcarrier periods in one video line}}{\text{Number of 27 MHz clk cycles in one video line}} \times 2^{32}$$

where the sum is rounded to the nearest integer. For example, in NTSC mode

$$\text{Subcarrier Register Value} = \left(\frac{227.5}{1716} \right) \times 2^{32} = 569408543$$

where:

$$\text{Subcarrier Register Value} = 569408543_{10} = 0 \times 21F07C1F_{16}$$

SD F_{sc} Register 0: 0x1F

SD F_{sc} Register 1: 0x7C

SD F_{sc} Register 2: 0xF0

SD F_{sc} Register 3: 0x21

Programming the F_{sc}

The subcarrier frequency register value is divided into four F_{sc} registers, as shown in the previous example. The four subcarrier frequency registers must be updated sequentially, starting with Subcarrier Frequency Register 0 and ending with Subcarrier Frequency Register 3. The subcarrier frequency updates only after the last subcarrier frequency register byte is received by the ADV7340/ADV7341. The SD input standard autodetection feature must be disabled.

Typical F_{sc} Values

Table 42 outlines the values that should be written to the subcarrier frequency registers for NTSC and PAL B/D/G/H/I.

Table 42. Typical F_{sc} Values

Subaddress	Description	NTSC	PAL B/D/G/H/I
0x8C	F _{sc} 0	0x1F	0xCB
0x8D	F _{sc} 1	0x7C	0x8A
0x8E	F _{sc} 2	0xF0	0x09
0x8F	F _{sc} 3	0x21	0x2A

SD NONINTERLACED MODE

Subaddress 0x88, Bit 1

The ADV7340/ADV7341 support an SD noninterlaced mode. Using this mode, progressive inputs at twice the frame rate of NTSC and PAL (240p/59.94 Hz and 288p/50 Hz, respectively) can be input into the ADV7340/ADV7341. The SD noninterlaced mode can be enabled using Subaddress 0x88, Bit 1.

A 27 MHz clock signal must be provided on the CLKIN_A pin. Embedded EAV/SAV timing codes or external horizontal and vertical synchronization signals provided on the S_HSYNC and S_VSYNC pins can be used to synchronize the input pixel data.

All input configurations, output configurations, and features available in NTSC and PAL modes are available in SD noninterlaced mode. For 240p/59.94 Hz input, the ADV7340/ADV7341 should be configured for NTSC operation, and Subaddress 0x88, Bit 1 should be set to 1.

For 288p/50 Hz input, the ADV7340/ADV7341 should be configured for PAL operation, and Subaddress 0x88, Bit 1 should be set to 1.

SD SQUARE PIXEL MODE

Subaddress 0x82, Bit 4

The ADV7340/ADV7341 support an SD square pixel mode (Subaddress 0x82, Bit 4). For NTSC operation, an input clock of 24.5454 MHz is required. The active resolution is 640 × 480. For PAL operation, an input clock of 29.5 MHz is required. The active resolution is 768 × 576.

For CVBS and S-Video (Y-C) outputs, the SD subcarrier frequency registers must be updated to reflect the input clock frequency used in SD square pixel mode. The SD input standard autodetection feature must be disabled in SD square pixel mode. In square pixel mode, the timing diagrams shown in Figure 60 and Figure 61 apply.

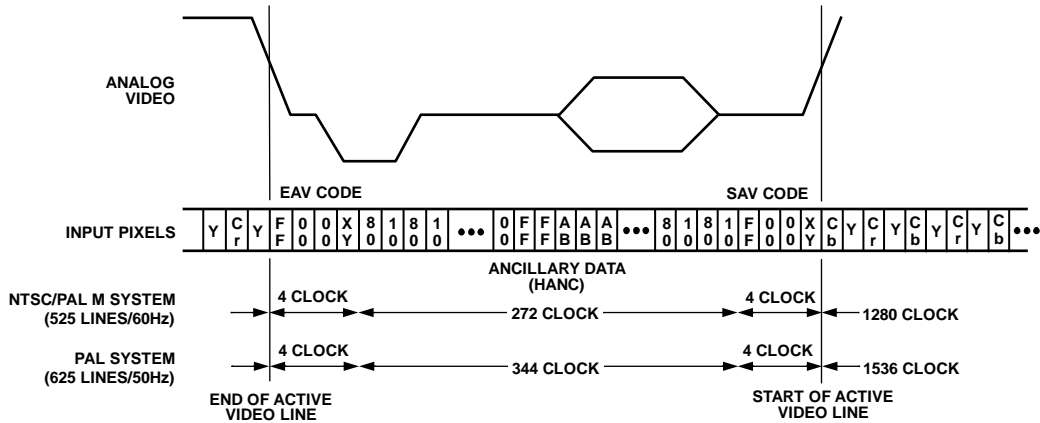

Figure 60. Square Pixel Mode EAV/SAV Embedded Timing

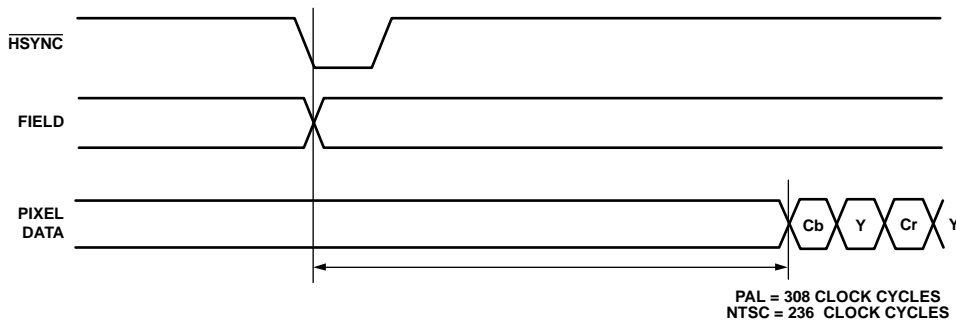

Figure 61. Square Pixel Mode Active Pixel Timing

FILTERS

Table 43 shows an overview of the programmable filters available on the ADV7340/ADV7341.

Table 43. Selectable Filters

Filter	Subaddress
SD Luma LPF NTSC	0x80
SD Luma LPF PAL	0x80
SD Luma Notch NTSC	0x80
SD Luma Notch PAL	0x80
SD Luma SSAF	0x80
SD Luma CIF	0x80
SD Luma QCIF	0x80
SD Chroma 0.65 MHz	0x80
SD Chroma 1.0 MHz	0x80
SD Chroma 1.3 MHz	0x80
SD Chroma 2.0 MHz	0x80
SD Chroma 3.0 MHz	0x80
SD Chroma CIF	0x80
SD Chroma QCIF	0x80
SD PrPb SSAF	0x82
ED/HD Chroma Input	0x33
ED/HD Sinc Compensation Filter	0x33
ED/HD Chroma SSAF	0x33

SD Internal Filter Response

Subaddress 0x80, Bits[7:2]; Subaddress 0x82, Bit 0

The Y filter supports several different frequency responses, including two low-pass responses, two notch responses, an extended (SSAF) response with or without gain boost attenuation, a CIF response, and a QCIF response. The PrPb filter supports several different frequency responses, including six low-pass responses, a CIF response, and a QCIF response, as shown in Figure 38 and Figure 39.

If SD SSAF gain is enabled (Subaddress 0x87, Bit 4), there are 13 response options in the -4 dB to +4 dB range. The desired response can be programmed using Subaddress 0xA2. The variation in frequency responses is shown in Figure 35 to Figure 37.

In addition to the chroma filters listed in Table 43, the ADV7340/ADV7341 contain an SSAF filter that is specifically designed for the color difference component outputs, Pr and Pb. This filter has a cutoff frequency of ~2.7 MHz and a gain of -40 dB at 3.8 MHz (see Figure 62). This filter can be controlled with Subaddress 0x82, Bit 0.

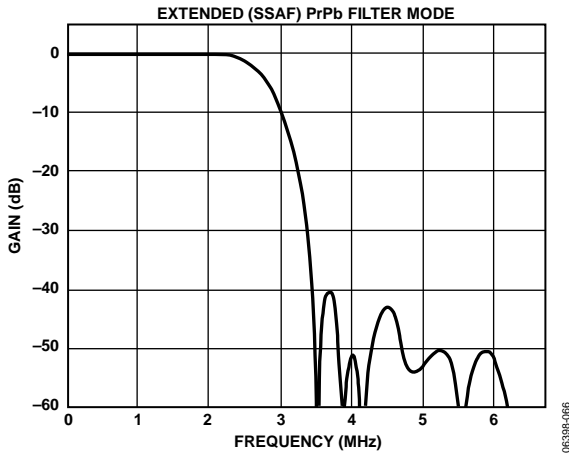

Figure 62. PrPb SSAF Filter

If this filter is disabled, one of the chroma filters shown in Table 44 can be selected and used for the CVBS or luma/ chroma signal.

Table 44. Internal Filter Specifications

Filter	Pass-Band Ripple (dB) ¹	3 dB Bandwidth (MHz) ²
Luma LPF NTSC	0.16	4.24
Luma LPF PAL	0.1	4.81
Luma Notch NTSC	0.09	2.3/4.9/6.6
Luma Notch PAL	0.1	3.1/5.6/6.4
Luma SSAF	0.04	6.45
Luma CIF	0.127	3.02
Luma QCIF	Monotonic	1.5
Chroma 0.65 MHz	Monotonic	0.65
Chroma 1.0 MHz	Monotonic	1
Chroma 1.3 MHz	0.09	1.395
Chroma 2.0 MHz	0.048	2.2
Chroma 3.0 MHz	Monotonic	3.2
Chroma CIF	Monotonic	0.65
Chroma QCIF	Monotonic	0.5

¹Pass-band ripple is the maximum fluctuation from the 0 dB response in the pass band, measured in decibels. The pass band is defined to have 0 Hz to f_c (Hz) frequency limits for a low-pass filter and 0 Hz to f_1 (Hz), and f_2 (Hz) to infinity for a notch filter, where f_c , f_1 , and f_2 are the -3 dB points.

²3 dB bandwidth refers to the -3 dB cutoff frequency.

ED/HD Sinc Compensation Filter Response

Subaddress 0x33, Bit 3

The ADV7340/ADV7341 include a filter designed to counter the effect of sinc roll-off in DAC 1, DAC 2, and DAC 3 while operating in ED/HD mode. This filter is enabled by default. It can be disabled using Subaddress 0x33, Bit 3. The benefit of the filter is illustrated in Figure 63 and Figure 64.

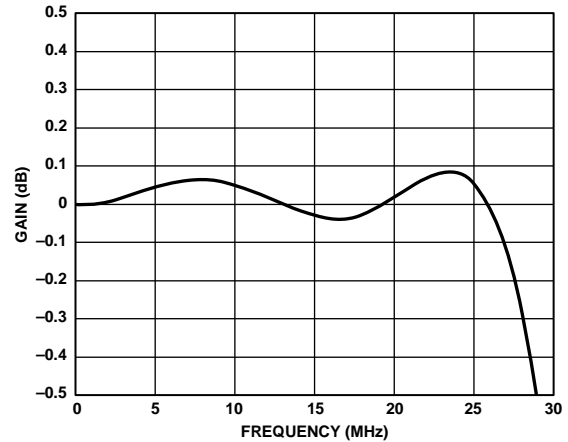

Figure 63. ED/HD Sinc Compensation Filter Enabled

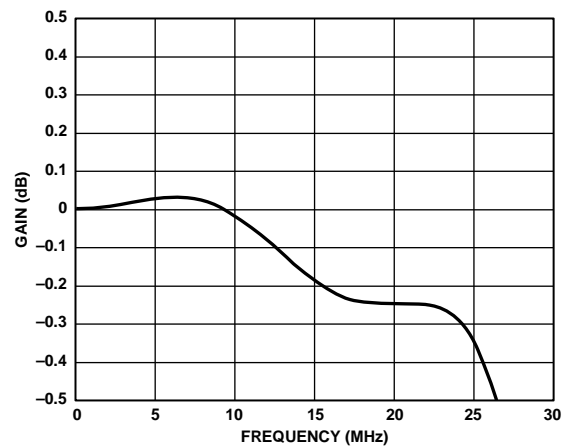

Figure 64. ED/HD Sinc Compensation Filter Disabled

ED/HD TEST PATTERN COLOR CONTROLS

Subaddress 0x36 to Subaddress 0x38

Three 8-bit registers at Subaddress 0x36 to Subaddress 0x38 are used to program the output color of the internal ED/HD test pattern generator (Subaddress 0x31, Bit 2 = 1), whether it be the lines of the crosshatch pattern or the uniform field test pattern. They are not functional as color controls for external pixel data input.

The values for the luma (Y) and the color difference (Cr and Cb) signals used to obtain white, black, and saturated primary and complementary colors conform to the ITU-R BT.601-4 standard.

Table 45 shows sample color values that can be programmed into the color registers when the output standard selection is set to EIA 770.2/EIA770.3 (Subaddress 0x30, Bits[1:0] = 00).

Table 45. Sample Color Values for EIA 770.2/EIA770.3 ED/HD Output Standard Selection

Sample Color	Y Value	Cr Value	Cb Value
White	235 (0xEB)	128 (0x80)	128 (0x80)
Black	16 (0x10)	128 (0x80)	128 (0x80)
Red	81 (0x51)	240 (0xF0)	90 (0x5A)
Green	145 (0x91)	34 (0x22)	54 (0x36)
Blue	41 (0x29)	110 (0x6E)	240 (0xF0)
Yellow	210 (0xD2)	146 (0x92)	16 (0x10)
Cyan	170 (0xAA)	16 (0x10)	166 (0xA6)
Magenta	106 (0x6A)	222 (0xDE)	202 (0xCA)

COLOR SPACE CONVERSION MATRIX

Subaddress 0x03 to Subaddress 0x09

The internal color space conversion (CSC) matrix automatically performs all color space conversions based on the input mode programmed in the mode select register (Subaddress 0x01, Bits[6:4]). Table 46 and Table 47 show the options available in this matrix.

An SD color space conversion from RGB-in to YPrPb-out is possible. An ED/HD color space conversion from RGB-in to YPrPb-out is not possible.

Table 46. SD Color Space Conversion Options

Input	Output ¹	YPrPb/RGB Out (Subaddress 0x02, Bit 5)	RGB In/YCrCb In (Subaddress 0x87, Bit 7)
YCrCb	YPrPb	1	0
YCrCb	RGB	0	0
RGB	YPrPb	1	1
RGB	RGB	0	1

¹ CVBS/YC outputs are available for all CSC combinations.

Table 47. ED/HD Color Space Conversion Options

Input	Output	YPrPb/RGB Out (Subaddress 0x02, Bit 5)	RGB In/YCrCb In (Subaddress 0x35, Bit 1)
YCrCb	YPrPb	1	0
YCrCb	RGB	0	0
RGB	RGB	0	1

SD Manual CSC Matrix Adjust Feature

The SD manual CSC matrix adjust feature provides custom coefficient manipulation for RGB to YPbPr conversion (for YPbPr to RGB conversion, this matrix adjustment is not available).

Normally, there is no need to modify the SD matrix coefficients because the CSC matrix automatically performs the color space conversion based on the output color space selected (see Table 46). Note that Bit 7 in Subaddress 0x87 must be set to enable RGB input and, therefore, use the CSC manual adjustment.

The SD CSC matrix scalar uses the following equations:

$$Y = (a1 \times R) + (a2 \times G) + (a3 \times B) + a4$$

$$Pr = (b1 \times R) + (b2 \times G) + (b3 \times B) + b4$$

$$Pb = (c1 \times R) + (c2 \times G) + (c3 \times B) + c4$$

The coefficients and their default values and register locations are shown in Table 48.

Table 48. SD Manual CSC Matrix Default Values

Coefficient	Subaddress	Default
a1	0xBD	0x42
a2	0xBE	0x81
a3	0xBF	0x19
a4	0xC0	0x10
b1	0xC1	0x70
b2	0xC2	0x5E
b3	0xC3	0x12
b4	0xC4	0x80
c1	0xC5	0x26
c2	0xC6	0x4A
c3	0xC7	0x70
c4	0xC8	0x80

ED/HD Manual CSC Matrix Adjust Feature

The ED/HD manual CSC matrix adjust feature provides custom coefficient manipulation for color space conversions and is used in ED and HD modes only. The ED/HD manual CSC matrix adjust feature can be enabled using Subaddress 0x02, Bit 3.

Normally, there is no need to enable this feature because the CSC matrix automatically performs the color space conversion based on the input mode chosen (ED or HD) and the input and output color spaces selected (see Table 47). For this reason, the ED/HD manual CSC matrix adjust feature is disabled by default.

If RGB output is selected, the ED/HD CSC matrix scalar uses the following equations:

$$R = GY \times Y + RV \times Pr$$

$$G = GY \times Y - (GU \times Pb) - (GV \times Pr)$$

$$B = GY \times Y + BU \times Pb$$

Note that subtractions are implemented in hardware.

If YPrPb output is selected, the following equations are used:

$$Y = GY \times Y$$

$$Pr = RV \times Pr$$

$$Pb = BU \times Pb$$

where:

GY = Subaddress 0x05, Bits[7:0] and Subaddress 0x03, Bits[1:0].

GU = Subaddress 0x06, Bits[7:0] and Subaddress 0x04, Bits[7:6].

GV = Subaddress 0x07, Bits[7:0] and Subaddress 0x04, Bits[5:4].

BU = Subaddress 0x08, Bits[7:0] and Subaddress 0x04, Bits[3:2].

RV = Subaddress 0x09, Bits[7:0] and Subaddress 0x04, Bits[1:0].

On power-up, the CSC matrix is programmed with the default values shown in Table 49.

Table 49. ED/HD Manual CSC Matrix Default Values

Subaddress	Default
0x03	0x03
0x04	0xF0
0x05	0x4E
0x06	0x0E
0x07	0x24
0x08	0x92
0x09	0x7C

When the ED/HD manual CSC matrix adjust feature is enabled, the default coefficient values in Subaddress 0x03 to Subaddress 0x09 are correct for the HD color space only. The color components are converted according to the following 1080i and 720p standards (SMPTE 274M, SMPTE 296M):

$$R = Y + 1.575Pr$$

$$G = Y - 0.468Pr - 0.187Pb$$

$$B = Y + 1.855Pb$$

The conversion coefficients should be multiplied by 315 before being written to the ED/HD CSC matrix registers. This is reflected in the default values for GY = 0x13B, GU = 0x03B, GV = 0x093, BU = 0x248, and RV = 0x1F0.

If the ED/HD manual CSC matrix adjust feature is enabled and another input standard (such as ED) is used, the scale values for GY, GU, GV, BU, and RV must be adjusted according to this input standard color space. The user should consider that the color component conversion may use different scale values.

For example, SMPTE 293M uses the following conversion:

$$R = Y + 1.402Pr$$

$$G = Y - 0.714Pr - 0.344Pb$$

$$B = Y + 1.773Pb$$

The programmable CSC matrix is used for external ED/HD pixel data and is not functional when internal test patterns are enabled.

Programming the CSC Matrix

If custom manipulation of the ED/HD CSC matrix coefficients is required for a YCrCb-to-RGB color space conversion, use the following procedure:

1. Enable the ED/HD manual CSC matrix adjust feature (Subaddress 0x02, Bit 3).
2. Set the output to RGB (Subaddress 0x02, Bit 5).
3. Disable sync on PrPb (Subaddress 0x35, Bit 2).
4. Enable sync on RGB (optional) (Subaddress 0x02, Bit 4).

The GY value controls the green signal output level, the BU value controls the blue signal output level, and the RV value controls the red signal output level.

SD LUMA AND COLOR SCALE CONTROL

Subaddress 0x9C to Subaddress 0x9F

When enabled, the SD luma and color scale control feature can be used to scale the SD Y, Cb, and Cr output levels. This feature can be enabled using Subaddress 0x87, Bit 0. This feature affects all SD output signals, that is, CVBS, Y-C, YPrPb, and RGB.

When enabled, three 10-bit registers (SD Y scale, SD Cb scale, and SD Cr scale) control the scaling of the SD Y, Cb, and Cr output levels. The SD Y scale register contains the scaling factor used to scale the Y level from 0.0 to 1.5 times its initial level. The SD Cb scale and SD Cr scale registers contain the scaling factors to scale the Cb and Cr levels from 0.0 to 2.0 times their initial levels, respectively.

The values to be written to these 10-bit registers are calculated using the following equation:

$$Y, Cb, \text{ or } Cr \text{ Scale Value} = \text{Scale Factor} \times 512$$

For example, if *Scale Factor* = 1.3

$$Y, Cb, \text{ or } Cr \text{ Scale Value} = 1.3 \times 512 = 665.6$$

$$Y, Cb, \text{ or } Cr \text{ Scale Value} = 666 \text{ (rounded to the nearest integer)}$$

$$Y, Cb, \text{ or } Cr \text{ Scale Value} = 1010 \ 0110 \ 10b$$

Subaddress 0x9C, SD scale LSB register = 0x2A

Subaddress 0x9D, SD Y scale register = 0xA6

Subaddress 0x9E, SD Cb scale register = 0xA6

Subaddress 0x9F, SD Cr scale register = 0xA6

It is recommended that the SD luma scale saturation feature (Subaddress 0x87, Bit 1) be enabled when scaling the Y output level to avoid excessive Y output levels.

SD HUE ADJUST CONTROL

Subaddress 0xA0

When enabled, the SD hue adjust control register (Subaddress 0xA0) is used to adjust the hue on the SD composite and chroma outputs. This feature can be enabled using Subaddress 0x87, Bit 2.

Subaddress 0xA0 contains the bits required to vary the hue of the video data, that is, the variance in phase of the subcarrier during active video with respect to the phase of the subcarrier during the color burst. The ADV7340/ADV7341 provide a range of $\pm 22.5^\circ$ in increments of 0.17578125° . For normal operation (zero adjustment), this register is set to 0x80. Value 0xFF and Value 0x00 represent the upper and lower limits, respectively, of the attainable adjustment in NTSC mode. Value 0xFF and Value 0x01 represent the upper and lower limits, respectively, of the attainable adjustment in PAL mode.

The hue adjust value is calculated using the following equation:

$$\text{Hue Adjust } (^\circ) = 0.17578125^\circ (HCR_d - 128)$$

where HCR_d is the hue adjust control register (decimal).

For example, to adjust the hue by $+4^\circ$, write 0x97 to the hue adjust control register.

$$\left(\frac{4}{0.17578125} \right) + 128 \approx 151d = 0x97$$

where the sum is rounded to the nearest integer.

To adjust the hue by -4° , write 0x69 to the hue adjust control register.

$$\left(\frac{-4}{0.17578125} \right) + 128 \approx 105d = 0x69$$

where the sum is rounded to the nearest integer.

SD BRIGHTNESS DETECT

Subaddress 0xBA

The ADV7340/ADV7341 allow monitoring of the brightness level of the incoming video data. This feature is used to monitor the average brightness of the incoming Y signal on a field-by-field basis. The information is read from the I²C and, based on this information, the color saturation, contrast, and brightness controls can be adjusted (for example, to compensate for very dark pictures).

The luma data is monitored in the active video area only. The average brightness I²C register is updated on the falling edge of every VSYNC signal. The SD brightness detect register (Subaddress 0xBA) is a read-only register.

SD BRIGHTNESS CONTROL

Subaddress 0xA1, Bits[6:0]

When this feature is enabled, the SD brightness/WSS control register (Subaddress 0xA1) is used to control brightness by adding a programmable setup level onto the scaled Y data. This feature can be enabled using Subaddress 0x87, Bit 3.

For NTSC with pedestal, the setup can vary from 0 IRE to 22.5 IRE. For NTSC without pedestal and for PAL, the setup can vary from -7.5 IRE to $+15$ IRE.

The SD brightness control register is an 8-bit register. The seven LSBs of this 8-bit register are used to control the brightness level, which can be a positive or negative value.

For example, to add a $+20$ IRE brightness level to an NTSC signal with pedestal, write 0x28 to Subaddress 0xA1.

$$\begin{aligned} 0 \times (\text{SD Brightness Value}) &= \\ 0 \times (\text{IRE Value} \times 2.015631) &= \\ 0 \times (20 \times 2.015631) &= 0 \times (40.31262) \approx 0x28 \end{aligned}$$

To add a -7 IRE brightness level to a PAL signal, write 0x72 to Subaddress 0xA1.

$$\begin{aligned} 0 \times (\text{SD Brightness Value}) &= \\ 0 \times (\text{IRE Value} \times 2.075631) &= \\ 0 \times (7 \times 2.075631) &= 0x(14.109417) \approx 0001110b \\ 0001110b \text{ into twos complement} &= 1110010b = 0x72 \end{aligned}$$

Table 50. Sample Brightness Control Values¹

Setup Level (NTSC) with Pedestal	Setup Level (NTSC) Without Pedestal	Setup Level (PAL)	Brightness Control Value
22.5 IRE	15 IRE	15 IRE	0x1E
15 IRE	7.5 IRE	7.5 IRE	0x0F
7.5 IRE	0 IRE	0 IRE	0x00
0 IRE	-7.5 IRE	-7.5 IRE	0x71

¹ Values in the range of 0x3F to 0x44 may result in an invalid output signal.

SD INPUT STANDARD AUTODETECTION

Subaddress 0x87, Bit 5

The ADV7340/ADV7341 include an SD input standard autodetect feature. This SD feature can be enabled by setting Subaddress 0x87, Bits[5: 1].

When enabled, the ADV7340/ADV7341 can automatically identify an NTSC or a PAL B/D/G/H/I input stream. The ADV7340/ADV7341 automatically update the subcarrier frequency registers with the appropriate value for the identified standard. The ADV7340/ADV7341 are also configured to correctly encode the identified standard.

The SD standard bits (Subaddress 0x80, Bits[1:0]) and the subcarrier frequency registers are not updated to reflect the identified standard. All registers retain their default or user-defined values.

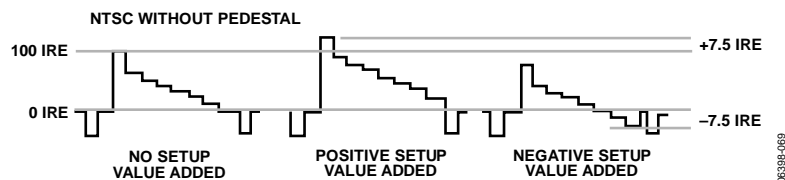

Figure 65. Examples of Brightness Control Values

DOUBLE BUFFERING

**Subaddress 0x33, Bit 7 for ED/HD;
Subaddress 0x88, Bit 2 for SD**

Double-buffered registers are updated once per field. Double buffering improves overall performance because modifications to register settings are not made during active video but take effect prior to the start of the active video on the next field.

Double buffering can be activated on the following ED/HD registers using Subaddress 0x33, Bit 7: the ED/HD Gamma A and Gamma B curves and ED/HD CGMS registers.

Double buffering can be activated on the following SD registers using Subaddress 0x88, Bit 2: the SD Gamma A and Gamma B curves, SD Y scale, SD Cr scale, SD Cb scale, SD brightness, SD closed captioning, and SD Macrovision Bits[5:0] (Subaddress 0xE0, Bits[5:0]).

PROGRAMMABLE DAC GAIN CONTROL

Subaddress 0x0A to Subaddress 0x0B

It is possible to adjust the DAC output signal gain up or down from its absolute level. This is illustrated in Figure 66.

DAC 4 to DAC 6 are controlled by Register 0x0A. DAC 1 to DAC 3 are controlled by Register 0x0B.

CASE A

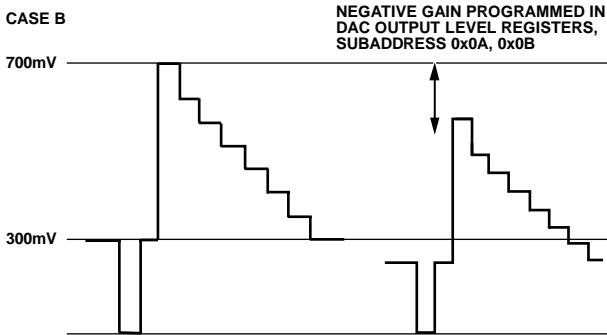
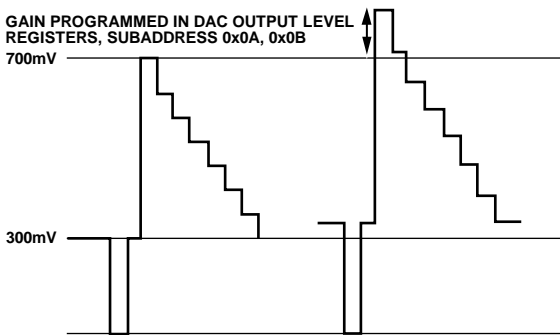

Figure 66. Programmable DAC Gain—Positive and Negative Gain

In Case A of Figure 66, the video output signal is gained. The absolute level of the sync tip and the blanking level increase with respect to the reference video output signal. The overall gain of the signal is increased from the reference signal.

In Case B of Figure 66, the video output signal is reduced. The absolute level of the sync tip and the blanking level decrease with respect to the reference video output signal. The overall gain of the signal is reduced from the reference signal.

The range of this feature is specified for ±7.5% of the nominal output from the DACs. For example, if the output current of the DAC is 4.33 mA, the DAC gain control feature can change this output current from 4.008 mA (−7.5%) to 4.658 mA (+7.5%).

The reset value of the control registers is 0x00; that is, nominal DAC current is output. Table 51 shows how the output current of the DACs varies for a nominal 4.33 mA output current.

Table 51. DAC Gain Control

Subaddress 0x0A or Subaddress 0x0B	DAC Current (mA)	% Gain	Note
0100 0000 (0x40)	4.658	7.5000%	
0011 1111 (0x3F)	4.653	7.3820%	
0011 1110 (0x3E)	4.648	7.3640%	
...	
...	
0000 0010 (0x02)	4.43	0.0360%	
0000 0001 (0x01)	4.38	0.0180%	
0000 0000 (0x00)	4.33	0.0000%	Reset value, nominal
1111 1111 (0xFF)	4.25	−0.0180%	
1111 1110 (0xFE)	4.23	−0.0360%	
...	
...	
1100 0010 (0xC2)	4.018	−7.3640%	
1100 0001 (0xC1)	4.013	−7.3820%	
1100 0000 (0xC0)	4.008	−7.5000%	

GAMMA CORRECTION

**Subaddress 0x44 to Subaddress 0x57 for ED/HD;
Subaddress 0xA6 to Subaddress 0xB9 for SD**

Generally, gamma correction is applied to compensate for the nonlinear relationship between signal input and output brightness level (as perceived on a CRT). It can also be applied wherever nonlinear processing is used.

Gamma correction uses the function

$$Signal_{OUT} = (Signal_{IN})^\gamma$$

where γ is the gamma correction factor.

Gamma correction is available for SD and ED/HD video. For both variations, there are twenty 8-bit registers. They are used to program the Gamma Correction Curve A and Gamma Correction Curve B.

ED/HD gamma correction is enabled using Subaddress 0x35, Bit 5. ED/HD Gamma Correction Curve A is programmed at Subaddress 0x44 to Subaddress 0x4D, and ED/HD Gamma Correction Curve B is programmed at Subaddress 0x4E to Subaddress 0x57.

SD gamma correction is enabled using Subaddress 0x88, Bit 6. SD Gamma Correction Curve A is programmed at Subaddress 0xA6 to Subaddress 0xAF, and SD Gamma Correction Curve B is programmed at Subaddress 0xB0 to Subaddress 0xB9.

Gamma correction is performed on the luma data only. The user can choose one of two correction curves, Curve A or Curve B. Only one of these curves can be used at a time. For ED/HD gamma correction, curve selection is controlled using Subaddress 0x35, Bit 4. For SD gamma correction, curve selection is controlled using Subaddress 0x88, Bit 7.

The shape of the gamma correction curve is controlled by defining the curve response at 10 different locations along the curve. By altering the response at these locations, the shape of the gamma correction curve can be modified. Between these points, linear interpolation is used to generate intermediate values. Considering that the curve has a total length of 256 points, the 10 programmable locations are at the following points: 24, 32, 48, 64, 80, 96, 128, 160, 192, and 224. The following locations are fixed and cannot be changed: 0, 16, 240, and 255.

From the curve locations, 16 to 240, the values at the programmable locations and, therefore, the response of the gamma correction curve, should be calculated to produce the following result:

$$X_{DESIRED} = (X_{INPUT})^{\gamma}$$

where:

$X_{DESIRED}$ is the desired gamma corrected output.

X_{INPUT} is the linear input signal.

γ is the gamma correction factor.

To program the gamma correction registers, calculate the 10 programmable curve values using the following formula:

$$\gamma_n = \left(\left(\frac{n-16}{240-16} \right)^{\gamma} \times (240-16) \right) + 16$$

where:

γ_n is the value to be written into the gamma correction register for point n on the gamma correction curve.

$n = 24, 32, 48, 64, 80, 96, 128, 160, 192, \text{ or } 224.$

γ is the gamma correction factor.

For example, setting $\gamma = 0.5$ for all programmable curve data points results in the following γ_n values:

$$\gamma_{24} = [(8/224)^{0.5} \times 224] + 16 = 58$$

$$\gamma_{32} = [(16/224)^{0.5} \times 224] + 16 = 76$$

$$\gamma_{48} = [(32/224)^{0.5} \times 224] + 16 = 101$$

$$\gamma_{64} = [(48/224)^{0.5} \times 224] + 16 = 120$$

$$\gamma_{80} = [(64/224)^{0.5} \times 224] + 16 = 136$$

$$\gamma_{96} = [(80/224)^{0.5} \times 224] + 16 = 150$$

$$\gamma_{128} = [(112/224)^{0.5} \times 224] + 16 = 174$$

$$\gamma_{160} = [(144/224)^{0.5} \times 224] + 16 = 195$$

$$\gamma_{192} = [(176/224)^{0.5} \times 224] + 16 = 214$$

$$\gamma_{224} = [(208/224)^{0.5} \times 224] + 16 = 232$$

where the sum of each equation is rounded to the nearest integer.

The gamma curves in Figure 67 and Figure 68 are examples only; any user-defined curve in the range from 16 to 240 is acceptable.

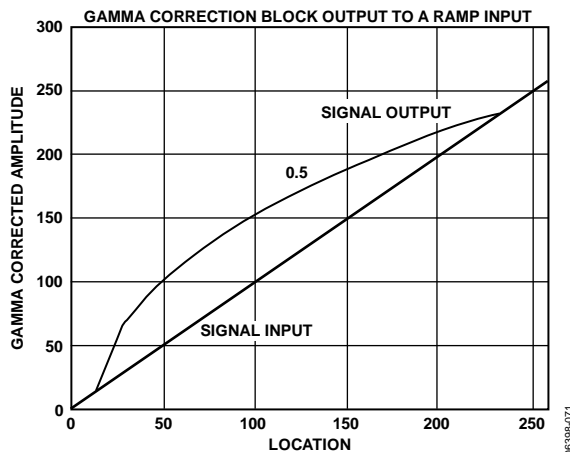

Figure 67. Signal Input (Ramp) and Signal Output for Gamma 0.5

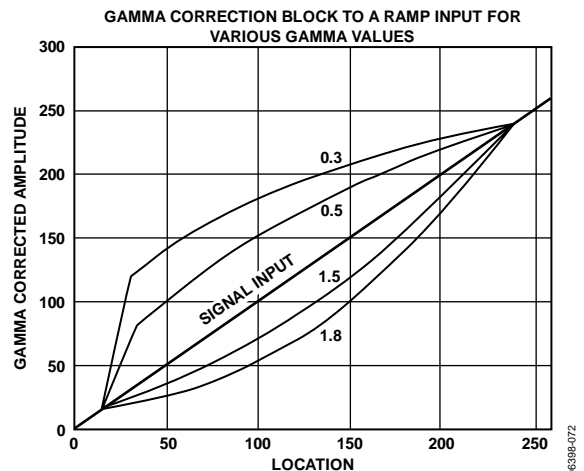

Figure 68. Signal Input (Ramp) and Selectable Output Curves

ED/HD SHARPNESS FILTER AND ADAPTIVE FILTER CONTROLS

Subaddress 0x40; Subaddress 0x58 to Subaddress 0x5D

There are three filter modes available on the ADV7340/ADV7341: a sharpness filter mode and two adaptive filter modes.

ED/HD Sharpness Filter Mode

To enhance or attenuate the Y signal in the frequency ranges shown in Figure 69, the ED/HD sharpness filter must be enabled (Subaddress 0x31, Bit 7) and the ED/HD adaptive filter must be disabled (Subaddress 0x35, Bit 7).

To select one of the 256 individual responses, the corresponding gain values, which range from -8 to +7 for each filter, must be programmed into the ED/HD sharpness filter gain register at Subaddress 0x40.

ED/HD Adaptive Filter Mode

The ED/HD adaptive filter (Threshold A, Threshold B, and Threshold C) registers, the ED/HD adaptive filter (Gain 1, Gain 2, and Gain 3) registers, and the ED/HD sharpness filter gain register are used in adaptive filter mode. To activate the adaptive filter control, the ED/HD sharpness filter and the ED/HD adaptive filter must be enabled (Subaddress 0x31, Bit 7, and Subaddress 0x35, Bit 7, respectively).

The derivative of the incoming signal is compared to the three programmable threshold values; that is the ED/HD adaptive filter (Threshold A, Threshold B, and Threshold C) registers (Subaddress 0x5B, Subaddress 0x5C, and Subaddress 0x5D, respectively). The recommended threshold range is 16 to 235, although any value in the range of 0 to 255 can be used.

The edges can then be attenuated with the settings in the ED/HD adaptive filter (Gain 1, Gain 2, and Gain 3) registers (Subaddress 0x58, Subaddress 0x59, and Subaddress 0x5A, respectively), and the ED/HD sharpness filter gain register (Subaddress 0x40).

There are two adaptive filter modes available. The mode is selected using the ED/HD adaptive filter mode control (Subaddress 0x35, Bit 6) as follows:

- Mode A is used when the ED/HD adaptive filter mode control is set to 0. In this case, Filter B (LPF) is used in the adaptive filter block. In addition, only the programmed values for Gain B in the ED/HD sharpness filter gain register and ED/HD adaptive filter (Gain 1, Gain 2, and Gain 3) registers are applied when needed. The Gain A values are fixed and cannot be changed.
- Mode B is used when ED/HD adaptive filter mode control is set to 1. In this mode, a cascade of Filter A and Filter B is used. Both settings for Gain A and Gain B in the ED/HD sharpness filter gain register and ED/HD adaptive filter (Gain 1, Gain 2, and Gain 3) registers become active when needed.

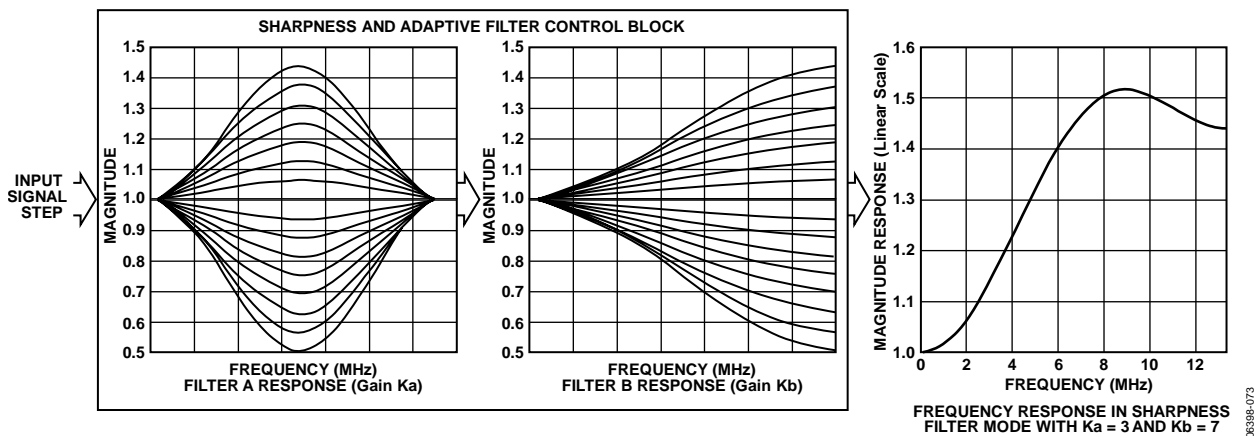

Figure 69. ED/HD Sharpness and Adaptive Filter Control Block

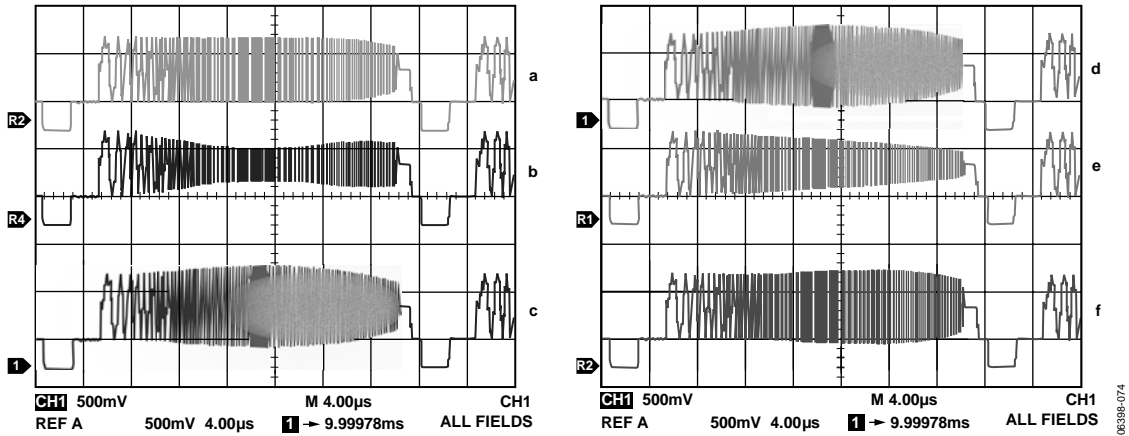

Figure 70. ED/HD Sharpness Filter Control with Different Gain Settings for ED/HD Sharpness Filter Gain Values

ED/HD SHARPNESS FILTER AND ADAPTIVE FILTER APPLICATION EXAMPLES

Sharpness Filter Application

The ED/HD sharpness filter can be used to enhance or attenuate the Y video output signal. The register settings in Table 52 are used to achieve the results shown in Figure 70. Input data is generated by an external signal source.

Table 52. ED/HD Sharpness Control Settings for Figure 70

Subaddress	Register Setting	Reference ¹
0x00	0xFC	
0x01	0x10	
0x02	0x20	
0x30	0x00	
0x31	0x81	
0x40	0x00	a
0x40	0x08	b
0x40	0x04	c
0x40	0x40	d
0x40	0x80	e
0x40	0x22	f

¹ See Figure 70.

Adaptive Filter Control Application

The register settings in Table 53 are used to obtain the results shown in Figure 72, that is, to remove the ringing on the input Y signal, as shown in Figure 71. Input data is generated by an external signal source.

Table 53. Register Settings for Figure 72

Subaddress	Register Setting
0x00	0xFC
0x01	0x38
0x02	0x20
0x30	0x00
0x31	0x81
0x35	0x80
0x40	0x00
0x58	0xAC
0x59	0x9A
0x5A	0x88
0x5B	0x28
0x5C	0x3F
0x5D	0x64

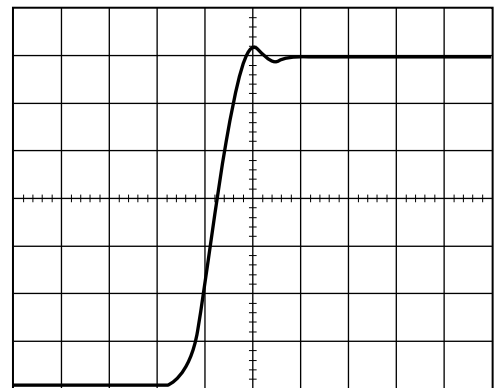

Figure 71. Input Signal to ED/HD Adaptive Filter

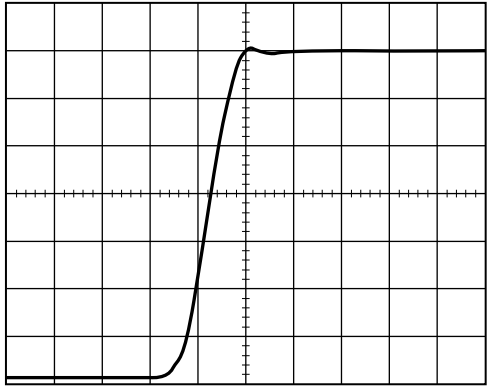

Figure 72. Output Signal from ED/HD Adaptive Filter (Mode A)

When the adaptive filter mode is changed to Mode B (Subaddress 0x35, Bit 6), the output shown in Figure 73 can be obtained.

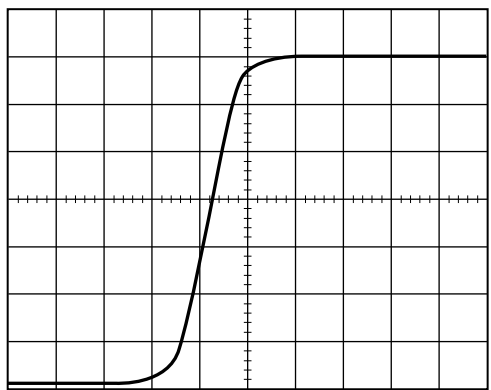

Figure 73. Output Signal from ED/HD Adaptive Filter (Mode B)

SD DIGITAL NOISE REDUCTION

Subaddress 0xA3 to Subaddress 0xA5

Digital noise reduction (DNR) is applied to the Y data only. A filter block selects the high frequency, low amplitude components of the incoming signal (DNR input select). The absolute value of the filter output is compared to a programmable threshold value (DNR threshold control). There are two DNR modes available: DNR mode and DNR sharpness mode.

In DNR mode, if the absolute value of the filter output is smaller than the threshold, it is assumed to be noise. A programmable amount (coring gain border, coring gain data) of this noise signal is subtracted from the original signal. In DNR sharpness mode, if the absolute value of the filter output is less than the programmed threshold, it is assumed to be noise. Otherwise, if the level exceeds the threshold, now identified as a valid signal, a fraction of the signal (coring gain border, coring gain data) is added to the original signal to boost high frequency components and sharpen the video image.

In MPEG systems, it is common to process the video information in blocks of 8 pixels × 8 pixels for MPEG2 systems or 16 pixels × 16 pixels for MPEG1 systems (block size control). DNR can be applied to the resulting block transition areas that are known to

contain noise. Generally, the block transition area contains two pixels. It is possible to define this area to contain four pixels (border area).

It is also possible to compensate for variable block positioning or differences in YCrCb pixel timing with the use of the DNR block offset.

The digital noise reduction registers are three 8-bit registers. They are used to control the DNR processing.

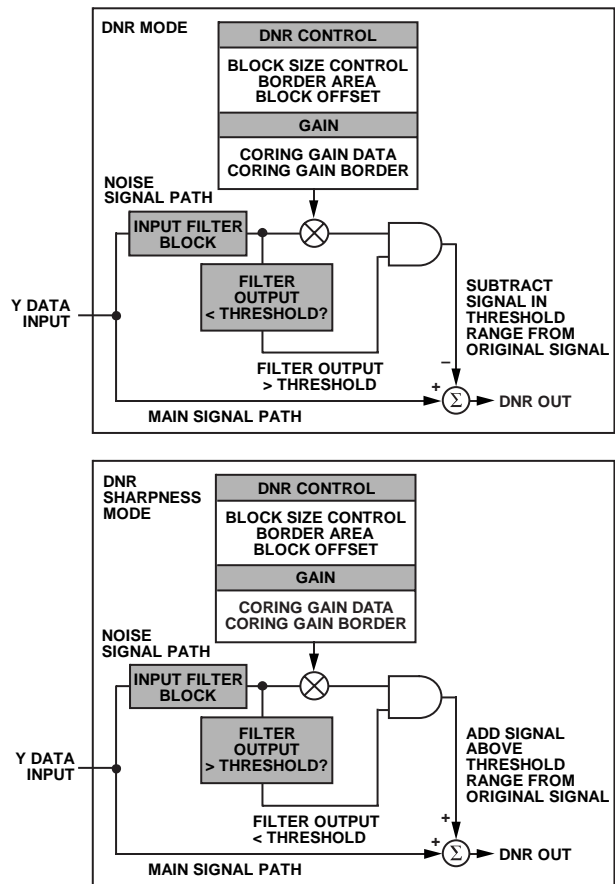

Figure 74. SD DNR Block Diagram

Coring Gain Border—Subaddress 0xA3, Bits[3:0]

These four bits are assigned to the gain factor applied to border areas. In DNR mode, the range of gain values is 0 to 1 in increments of 1/8. This factor is applied to the DNR filter output that lies below the set threshold range. The result is then subtracted from the original signal.

In DNR sharpness mode, the range of gain values is 0 to 0.5 in increments of 1/16. This factor is applied to the DNR filter output that lies above the threshold range. The result is added to the original signal.

Coring Gain Data—Subaddress 0xA3, Bits[7:4]

These four bits are assigned to the gain factor applied to the luma data inside the MPEG pixel block. In DNR mode, the range of gain values is 0 to 1 in increments of 1/8. This factor is applied

to the DNR filter output that lies below the set threshold range. The result is then subtracted from the original signal.

In DNR sharpness mode, the range of gain values is 0 to 0.5 in increments of 1/16. This factor is applied to the DNR filter output that lies above the threshold range. The result is added to the original signal.

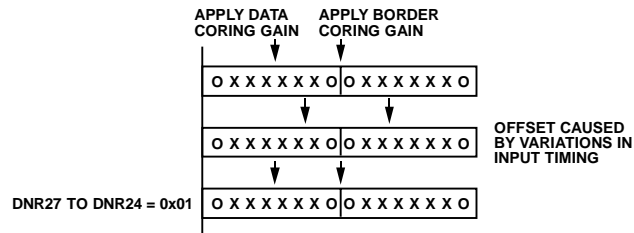

Figure 75. SD DNR Offset Control

DNR Threshold—Subaddress 0xA4, Bits[5:0]

These six bits are used to define the threshold value in the range of 0 to 63. The range is an absolute value.

Border Area—Subaddress 0xA4, Bit 6

When this bit is set to Logic 1, the block transition area can be defined to consist of four pixels. If this bit is set to Logic 0, the border transition area consists of two pixels, where one pixel refers to two clock cycles at 27 MHz.

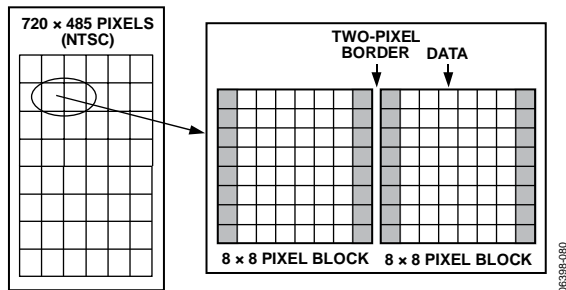

Figure 76. SD DNR Border Area

Block Size Control—Subaddress 0xA4, Bit 7

This bit is used to select the size of the data blocks to be processed. Setting the block size control function to Logic 1 defines a 16 pixel x 16 pixel data block, and Logic 0 defines an 8 pixel x 8 pixel data block, where one pixel refers to two clock cycles at 27 MHz.

DNR Input Select Control—Subaddress 0xA5, Bits[2:0]

Three bits are assigned to select the filter, which is applied to the incoming Y data. The signal that lies in the pass band of the selected filter is the signal that is DNR processed. Figure 77 shows the filter responses selectable with this control.

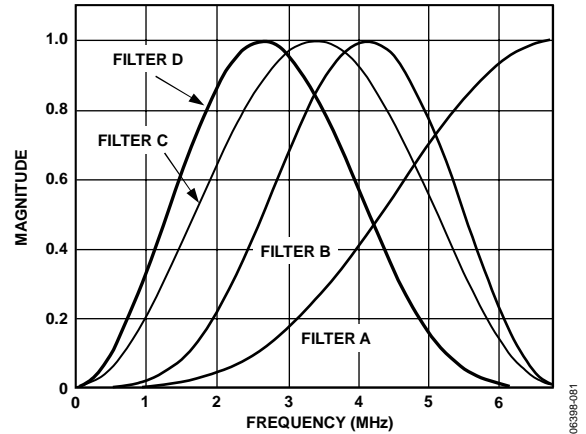

Figure 77. SD DNR Input Select

DNR Mode Control—Subaddress 0xA5, Bit 3

This bit controls the DNR mode selected. Logic 0 selects DNR mode; Logic 1 selects DNR sharpness mode.

DNR works on the principle of defining low amplitude, high frequency signals as probable noise and subtracting this noise from the original signal.

In DNR mode, it is possible to subtract a fraction of the signal that lies below the set threshold, assumed to be noise, from the original signal. The threshold is set in DNR Register 1.

When DNR sharpness mode is enabled, it is possible to add a fraction of the signal that lies above the set threshold to the original signal because this data is assumed to be valid data and not noise. The overall effect is that the signal is boosted (similar to using the extended SSAF filter).

DNR Block Offset Control—Subaddress 0xA5, Bits[7:4]

Four bits are assigned to this control, which allows a shift of the data block of 15 pixels maximum. Consider the coring gain positions fixed. The block offset shifts the data in steps of one pixel such that the border coring gain factors can be applied at the same position regardless of variations in input timing of the data.

SD ACTIVE VIDEO EDGE CONTROL

Subaddress 0x82, Bit 7

The ADV7340/ADV7341 are able to control fast rising and falling signals at the start and end of active video in order to minimize ringing.

When the active video edge control feature is enabled (Subaddress 0x82, Bit 7 = 1), the first three pixels and the last three pixels of the active video on the luma channel are scaled so that maximum transitions on these pixels are not possible.

At the start of active video, the first three pixels are multiplied by 1/8, 1/2, and 7/8, respectively. Approaching the end of active video, the last three pixels are multiplied by 7/8, 1/2, and 1/8, respectively. All other active video pixels pass through unprocessed.

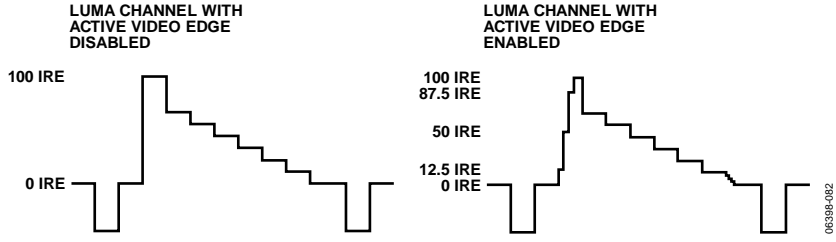

Figure 78. Example of Active Video Edge Functionality

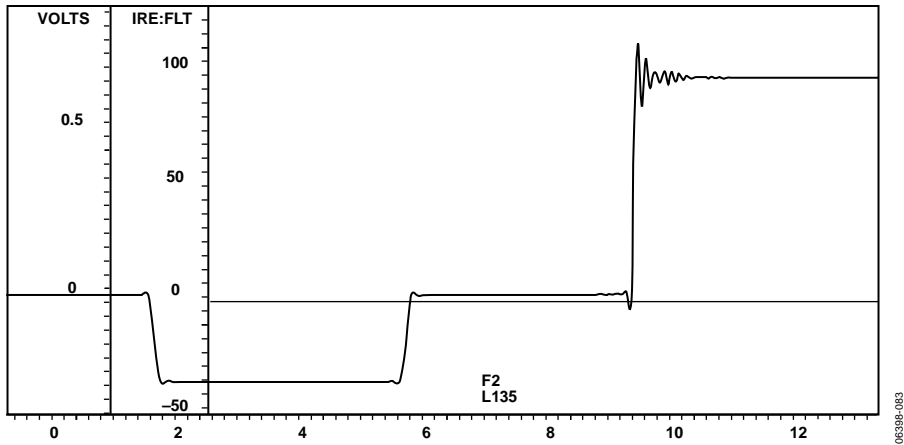

Figure 79. Example of Video Output with Subaddress 0x82, Bit 7 = 0

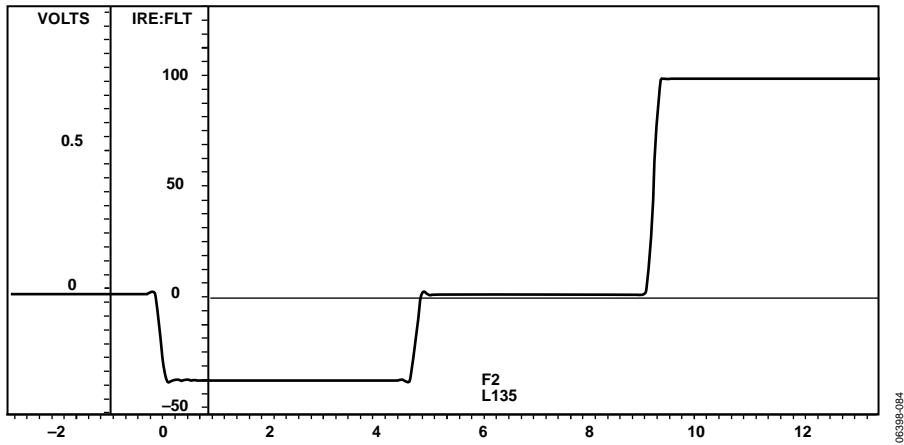

Figure 80. Example of Video Output with Subaddress 0x82, Bit 7 = 1

EXTERNAL HORIZONTAL AND VERTICAL SYNCHRONIZATION CONTROL

For synchronization purposes, the ADV7340/ADV7341 are able to accept either time codes embedded in the input pixel data or external synchronization signals provided on the $\overline{S_HSYNC}$, $\overline{S_VSYNC}$, $\overline{P_HSYNC}$, $\overline{P_VSYNC}$, and $\overline{P_BLANK}$ pins (see Table 54). It is also possible to output synchronization signals on the $\overline{S_HSYNC}$ and $\overline{S_VSYNC}$ pins (see Table 55 to Table 57).

Table 54. Timing Synchronization Signal Input Options

Signal	Pin	Condition
SD \overline{HSYNC} In	$\overline{S_HSYNC}$	SD slave timing mode (1, 2, or 3) selected (Subaddress 0x8A[2:0]). ¹
SD \overline{VSYNC} In	$\overline{S_VSYNC}$	SD Slave timing mode (1, 2, or 3) selected (Subaddress 0x8A[2:0]). ¹
ED/HD \overline{HSYNC} In	$\overline{P_HSYNC}$	ED/HD timing sync; inputs enabled (Subaddress 0x30, Bit 2 = 0).
ED/HD \overline{VSYNC} In	$\overline{P_VSYNC}$	ED/HD timing sync; inputs enabled (Subaddress 0x30, Bit 2 = 0).
ED/HD \overline{BLANK} In	$\overline{P_BLANK}$	

¹SD and ED/HD timing sync. Outputs must also be disabled (Subaddress 0x02[7:6] = 00).

Table 55. Timing Synchronization Signal Output Options

Signal	Pin	Condition
SD \overline{HSYNC} Out	$\overline{S_HSYNC}$	SD timing sync; outputs enabled (Subaddress 0x02, Bit 6 = 1). ¹
SD \overline{VSYNC} Out	$\overline{S_VSYNC}$	SD timing sync; outputs enabled (Subaddress 0x02, Bit 6 = 1). ¹
ED/HD \overline{HSYNC} Out	$\overline{S_HSYNC}$	ED/HD timing sync; outputs enabled (Subaddress 0x02, Bit 7 = 1).
ED/HD \overline{VSYNC} Out	$\overline{S_VSYNC}$	ED/HD timing sync; outputs enabled (Subaddress 0x02, Bit 7 = 1).

¹ED/HD timing sync. Outputs must also be disabled (Subaddress 0x02, Bit 7 = 0).

Table 56. HSYNC Output Control^{1, 2}

ED/HD Input Sync Format (Subaddress 0x30, Bit 2)	ED/HD \overline{HSYNC} Control (Subaddress 0x34, Bit 1)	ED/HD Sync Output Enable (Subaddress 0x02, Bit 7)	SD Sync Output Enable (Subaddress 0x02, Bit 6)	Signal on $\overline{S_HSYNC}$ Pin	Duration
X	X	0	0	Three-state.	N/A.
X	X	0	1	Pipelined SD \overline{HSYNC} .	See the SD Timing section.
0	0	1	X	Pipelined ED/HD \overline{HSYNC} .	As per \overline{HSYNC} timing.
1	0	1	X	Pipelined ED/HD \overline{HSYNC} based on the AV Code H bit.	Same as line blanking interval.
X	1	1	X	Pipelined ED/HD \overline{HSYNC} based on the horizontal counter.	Same as embedded \overline{HSYNC} .

¹ In all ED/HD standards where there is an \overline{HSYNC} output, the start of the \overline{HSYNC} pulse is aligned with the falling edge of the embedded \overline{HSYNC} in the output video.

² X = don't care.

Table 57. $\overline{\text{VSYNC}}$ Output Control^{1, 2}

ED/HD Input Sync Format (Subaddress 0x30, Bit 2)	ED/HD $\overline{\text{VSYNC}}$ Control (Subaddress 0x34, Bit 2)	ED/HD Sync Output Enable (Subaddress 0x02, Bit 7)	SD Sync Output Enable (Subaddress 0x02, Bit 6)	Video Standard	Signal on $\overline{\text{S_VSYNC}}$ Pin	Duration
X	X	0	0	X	Three-state	N/A
X	X	0	1	Interlaced	Pipelined SD $\overline{\text{VSYNC}}$ /Field	See SD Timing
0	0	1	X	X	Pipelined ED/HD $\overline{\text{VSYNC}}$ or field signal	As per $\overline{\text{VSYNC}}$ or field signal timing
1	0	1	X	All HD interlaced standards	Pipelined field signal based on the AV Code F bit	Field
1	0	1	X	All ED/HD progressive standards	Pipelined $\overline{\text{VSYNC}}$ based on the AV Code V bit	Vertical blanking interval
X	1	1	X	All ED/HD standards except 525p	Pipelined ED/HD $\overline{\text{VSYNC}}$ based on the vertical counter	Aligned with serration lines
X	1	1	X	525p	Pipelined ED/HD $\overline{\text{VSYNC}}$ based on the vertical counter	Vertical blanking interval

¹ In all ED/HD standards where there is a $\overline{\text{VSYNC}}$ output, the start of the $\overline{\text{VSYNC}}$ pulse is aligned with the falling edge of the embedded $\overline{\text{VSYNC}}$ in the output video.

² X = don't care.

LOW POWER MODE

Subaddress 0x0D, Bits[2:0]

For power-sensitive applications, the ADV7340/ADV7341 support an Analog Devices proprietary low power mode of operation on DAC 1, DAC 2, and DAC 3. To use this low power mode, these DACs must be operating in full-drive mode ($R_{SET1} = 510 \Omega$, $R_L = 37.5 \Omega$). Low power mode is not available in low-drive mode ($R_{SET} = 4.12 \text{ k}\Omega$, $R_L = 300 \Omega$). Low power mode can be independently enabled or disabled on DAC 1, DAC 2, and DAC 3 using Subaddress 0x0D, Bits[2:0]. Low power mode is disabled by default on each DAC.

In low power mode, DAC current consumption is content dependent. On a typical video stream, it can be reduced by as much as 40%. For applications requiring the highest possible video performance, low power mode should be disabled.

CABLE DETECTION

Subaddress 0x10

The ADV7340/ADV7341 include an Analog Devices proprietary cable detection feature. The cable detection feature is available on DAC 1 and DAC 2, while operating in full-drive mode ($R_{SET1} = 510 \Omega$, $R_{L1} = 37.5 \Omega$, assuming a connected cable). The feature is not available in low-drive mode ($R_{SET1} = 4.12 \text{ k}\Omega$, $R_L = 300 \Omega$). For a DAC to be monitored, the DAC must be powered up in Subaddress 0x00.

The cable detection feature can be used with all SD, ED, and HD video standards. It is available for all output configurations, that is, CVBS, YC, YPrPb, and RGB output configurations.

For CVBS/YC output configurations, both DAC 1 and DAC 2 are monitored; that is, the CVBS and YC luma outputs are monitored. For YPrPb and RGB output configurations, only

DAC 1 is monitored; that is, the luma or green output is monitored.

Once per frame, the ADV7340/ADV7341 monitor DAC 1 and/or DAC 2, updating Subaddress 0x10, Bit 0 and Bit 1, respectively. If a cable is detected on one of the DACs, the relevant bit is set to 0. If not, the bit is set to 1.

DAC AUTOPOWER-DOWN

Subaddress 0x10, Bit 4

For power-sensitive applications, a DAC autopower-down feature can be enabled using Subaddress 0x10, Bit 4. This feature is available only when the cable detection feature is enabled.

With this feature enabled, the cable detection circuitry monitors DAC 1 and/or DAC 2 once per frame. If they are unconnected, some or all of the DACs automatically power down. Which DAC or DACs are powered down depends on the selected output configuration.

For CVBS/YC output configurations, if DAC 1 is unconnected, only DAC 1 powers down. If DAC 2 is unconnected, DAC 2 and DAC 3 power down.

For YPrPb and RGB output configurations, if DAC 1 is unconnected, all three DACs power down. DAC 2 is not monitored for YPrPb and RGB output configurations.

Once per frame, DAC 1 and/or DAC 2 is monitored. If a cable is detected, the appropriate DAC or DACs remain powered up for the duration of the frame. If no cable is detected, the appropriate DAC or DACs power down until the next frame when the process is repeated.

SLEEP MODE

Subaddress 0x00, Bit 0

In sleep mode, most of the digital I/O pins of the ADV7340/ADV7341 are disabled. For inputs, this means that the external data is ignored, and internally the logic normally driven by a given input is just tied low or high. This includes CLKINx.

For digital output pins, this means that the pin goes into three-state (high impedance) mode.

There are some exceptions to allow the user to continue to communicate with the part via I²C: the SDA, and SCL pins are kept alive.

PIXEL AND CONTROL PORT READBACK

Subaddress 0x12 to Subaddress 0x16

The ADV7340/ADV7341 support the readback of most digital inputs via the I²C MPU port. This feature is useful for board-level connectivity testing with upstream devices.

The pixel port (S[9:0], Y[9:0], and C[9:0]), the control port (S_HSYNC, S_VSYNC, P_HSYNC, P_VSYNC, and P_BLANK), and the SFL pin are available for readback via the MPU port. The readback registers are located at Subaddress 0x12 to Subaddress 0x16.

When using this feature, apply a clock signal to the CLKIN_A pin in order to register the levels applied to the input pins.

RESET MECHANISM

Subaddress 0x17, Bit 1

The ADV7340/ADV7341 have a software reset accessible via the I²C MPU port. A software reset is activated by writing a 1 to Subaddress 0x17, Bit 1. This resets all registers to their default values. This bit is self-clearing; that is, after a 1 has been written to the bit, the bit automatically returns to 0.

The ADV7340/ADV7341 include a power-on reset (POR) circuit to ensure correct operation after power-up.

SD TELETEXT INSERTION

Subaddress 0xC9 to Subaddress 0xCE

The ADV7340/ADV7341 supports the insertion of teletext data, using a 2-pin interface, when operating in PAL mode. Teletext insertion is enabled using Subaddress 0xC9, Bit 0.

In accordance with the PAL WST teletext standard, teletext data should be inserted into the ADV7340/ADV7341 at a rate of 6.9375 Mbps. The teletext data can be inserted on the S_VSYNC, P_VSYNC, or C0 pin. The pin on which the teletext data is inserted is selected using Subaddress 0xC9, Bits[3:2].

When teletext insertion is enabled, a teletext request signal is output from the ADV7340/ADV7341 to indicate when teletext data should be inserted. The teletext request signal is output on the SFL pin. The position (relative to the teletext data) and width of the request signal are configurable using Subaddress 0xCA. The request signal can operate in either line or bit mode. The request signal mode is controlled using Subaddress 0xC9, Bit 1.

To account for the noninteger relationship between the teletext insertion rate (6.9375 Mbps) and the pixel clock (27 MHz), a teletext insertion protocol is implemented in the ADV7340/ADV7341. At a rate of 6.9375 Mbps, the time taken for the insertion of 37 teletext bits equates to 144 pixel clock cycles (at 27 MHz). For every 37 teletext bits inserted into the ADV7340/ADV7341, the 10th, 19th, 28th, and 37th bits are carried for three pixel clock cycles, and the remainder are carried for four pixel clock cycles (totaling 144 pixel clock cycles). The teletext insertion protocol repeats every 37 teletext bits or 144 pixel clock cycles until all 360 teletext bits are inserted.

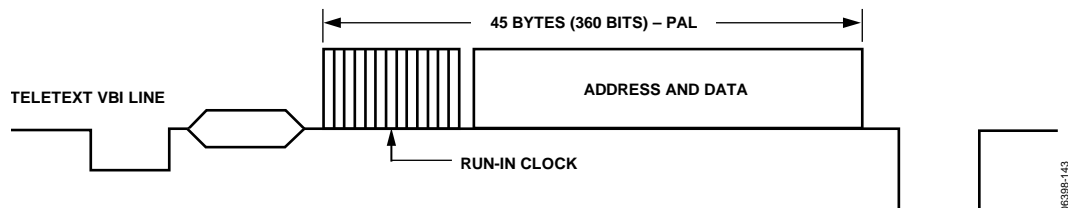
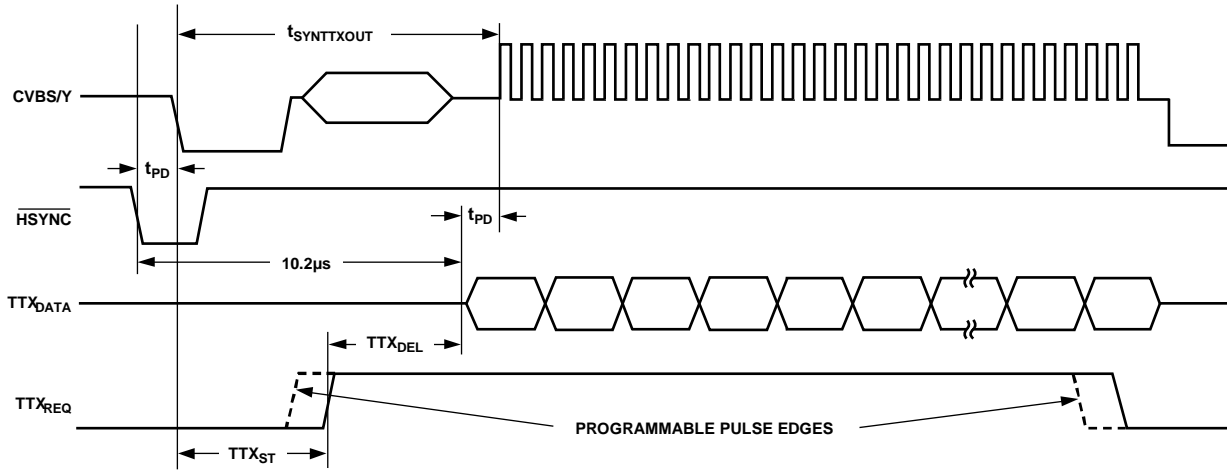

Figure 81. Teletext VBI Line

06398-143



$t_{SYNTTXOUT} = 10.2\mu s$.
 t_{PD} = PIPELINE DELAY THROUGH ADV7340/ADC7341.
 TTX_{DEL} = TTX_{REQ} TO TTX_{DATA} (PROGRAMMABLE RANGE = 4 BITS [0 TO 15 PIXEL CLOCK CYCLES]).

06398-144

Figure 82. Teletext Functionality Diagram

PRINTED CIRCUIT BOARD LAYOUT AND DESIGN

UNUSED PINS

If the $\overline{S_HSYNC}$, $\overline{S_VSYNC}$, $\overline{P_HSYNC}$, and $\overline{P_VSYNC}$ pins are not used, they should be tied to V_{DD_IO} through a pull-up resistor (10 k Ω or 4.7 k Ω). Any other unused digital inputs should be tied to ground. Unused digital output pins should be left floating. DAC outputs can be either left floating or connected to GND. Disabling these outputs is recommended.

DAC CONFIGURATIONS

The ADV7340/ADV7341 contain six DACs. All six DACs can be configured to operate in low-drive mode. Low-drive mode is defined as 4.33 mA full-scale current into a 300 Ω load, R_L .

DAC 1, DAC 2, and DAC 3 can also be configured to operate in full-drive mode. Full-drive mode is defined as 34.7 mA full-scale current into a 37.5 Ω load, R_L . Full drive is the recommended mode of operation for DAC 1, DAC 2, and DAC 3.

The ADV7340/ADV7341 contain two R_{SET} pins. A resistor connected between the R_{SET1} pin and AGND is used to control the full-scale output current and, therefore, the DAC output voltage levels of DAC 1, DAC 2, and DAC 3. For low-drive operation, R_{SET1} must have a value of 4.12 k Ω , and R_L must have a value of 300 Ω . For full-drive operation, R_{SET1} must have a value of 510 Ω , and R_L must have a value of 37.5 Ω .

A resistor connected between the R_{SET2} pin and AGND is used to control the full-scale output current and, therefore, the DAC output voltage levels of DAC 4, DAC 5, and DAC 6. R_{SET2} must have a value of 4.12 k Ω , and R_L must have a value of 300 Ω (that is, low-drive operation only).

The resistors connected to the R_{SET1} and R_{SET2} pins should have a 1% tolerance.

The ADV7340/ADV7341 contain two compensation pins, COMP1 and COMP2. A 2.2 nF compensation capacitor should be connected from each of these pins to V_{AA} .

VOLTAGE REFERENCE

The ADV7340/ADV7341 contain an on-chip voltage reference that can be used as a board-level voltage reference via the V_{REF} pin. Alternatively, the ADV7340/ADV7341 can be used with an external voltage reference by connecting the reference source to the V_{REF} pin. For optimal performance, use an external voltage reference such as the AD1580 with the ADV7340/ADV7341. If an external voltage reference is not used, a 0.1 μ F capacitor should be connected from the V_{REF} pin to V_{AA} .

VIDEO OUTPUT BUFFER AND OPTIONAL OUTPUT FILTER

An output buffer is necessary on any DAC that operates in low-drive mode ($R_{SETX} = 4.12$ k Ω , $R_L = 300$ Ω). Analog Devices produces a range of op amps suitable for this application, for example, the AD8061. For more information about line driver buffering circuits, see the relevant op amp data sheet.

An optional reconstruction (anti-imaging) low-pass filter (LPF) may be required on the ADV7340/ADV7341 DAC outputs if the part is connected to a device that requires this filtering.

The filter specifications vary with the application. The use of 16 \times (SD), 8 \times (ED), or 4 \times (HD) oversampling can remove the requirement for a reconstruction filter altogether.

For applications requiring an output buffer and reconstruction filter, the ADA4430-1, ADA4411-3, and ADA4410-6 integrated video filter buffers should be considered.

Table 58. ADV7340/ADV7341 Output Rates

Input Mode (Subaddress 0x01, Bits[6:4])	PLL Control (Subaddress 0x00, Bit 1)	Output Rate (MHz)	
		Rate	Multiplier
SD Only	Off	27	(2x)
	On	216	(16x)
ED Only	Off	27	(1x)
	On	216	(8x)
HD Only	Off	74.25	(1x)
	On	297	(4x)

Table 59. Output Filter Requirements

Application	Oversampling	Cutoff Frequency (MHz)	Attenuation -50 dB at (MHz)
SD	2 \times	>6.5	20.5
SD	16 \times	>6.5	209.5
ED	1 \times	>12.5	14.5
ED	8 \times	>12.5	203.5
HD	1 \times	>30	44.25
HD	4 \times	>30	267

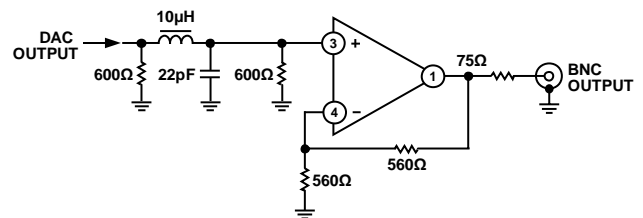

Figure 83. Example of Output Filter for SD, 16 \times Oversampling

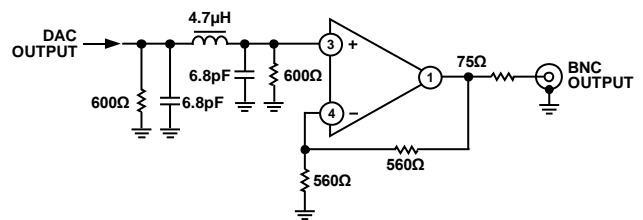

Figure 84. Example of Output Filter for ED, 8 \times Oversampling

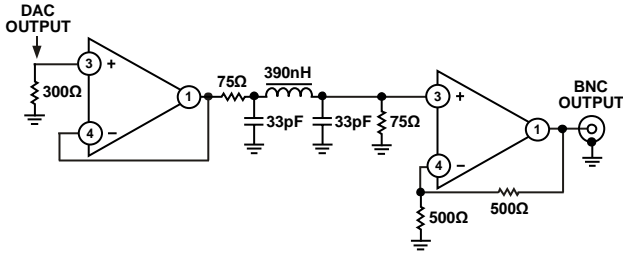

Figure 85. Example of Output Filter for HD, 4x Oversampling

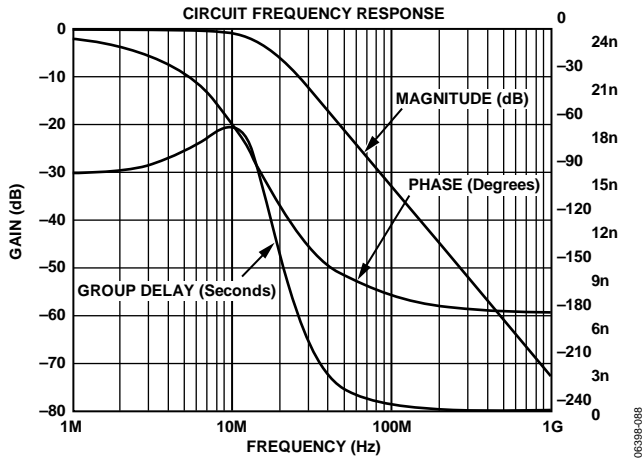

Figure 86. Output Filter Plot for SD, 16x Oversampling

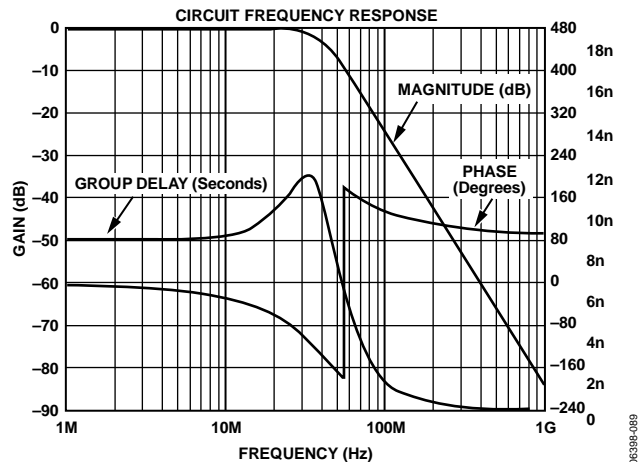

Figure 87. Output Filter Plot for ED, 8x Oversampling

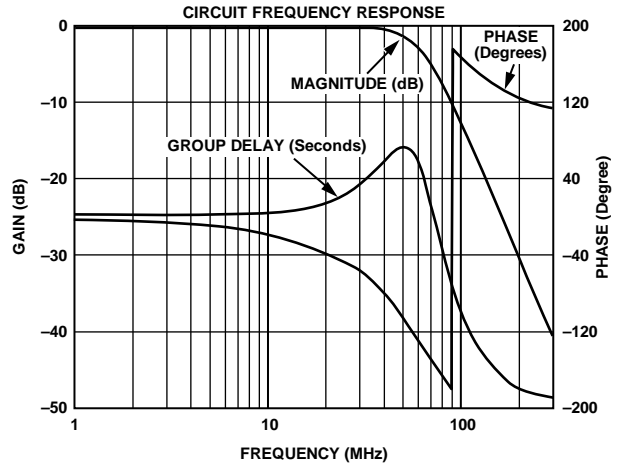

Figure 88. Output Filter Plot for HD, 4x Oversampling

PRINTED CIRCUIT BOARD (PCB) LAYOUT

The ADV7340/ADV7341 are highly integrated circuits containing both precision analog and high speed digital circuitry. They are designed to minimize interference effects on the integrity of the analog circuitry by the high speed digital circuitry. It is imperative that these same design and layout techniques be applied to the system-level design so that optimal performance is achieved.

The layout should be optimized for lowest noise on the ADV7340/ADV7341 power and ground planes by shielding the digital inputs and providing good power supply decoupling.

It is recommended to use a 4-layer printed circuit board with ground and power planes separating the signal trace layer and the solder side layer.

Component Placement

Component placement should be carefully considered to separate noisy circuits, such as clock signals and high speed digital circuitry, from analog circuitry. The external loop filter components and components connected to the COMP, V_{REF}, and R_{SETX} pins should be placed as close as possible to, and on the same side of the PCB as, the ADV7340/ ADV7341.

Adding vias to the PCB to get the components closer to the ADV7340/ADV7341 is not recommended. It is recommended to place the ADV7340/ADV7341 as close as possible to the output connector, with the DAC output traces as short as possible. The termination resistors on the DAC output traces should be placed as close as possible to and on the same side of the PCB as the ADV7340/ADV7341. The termination resistors should overlay the PCB ground plane.

External filter and buffer components connected to the DAC outputs should be placed as close as possible to the ADV7340/ADV7341 to minimize the possibility of noise pickup from neighboring circuitry and to minimize the effect of trace capacitance on output bandwidth. This is particularly important when operating in low-drive mode ($R_{SETX} = 4.12 \text{ k}\Omega$, $R_L = 300 \Omega$).

Power Supplies

It is recommended that a separate regulated supply be provided for each power domain (V_{AA} , V_{DD} , $V_{DD_{IO}}$, and PV_{DD}). For optimal performance, linear regulators rather than switch mode regulators should be used. If switch mode regulators must be used, care must be taken with regard to the quality of the output voltage in terms of ripple and noise. This is particularly true for the V_{AA} and PV_{DD} power domains. Each power supply should be individually connected to the system power supply at a single point through a suitable filtering device, such as a ferrite bead.

Power Supply Decoupling

It is recommended that each power supply pin be decoupled with 10 nF and 0.1 μF ceramic capacitors. The V_{AA} , PV_{DD} , $V_{DD_{IO}}$, and both V_{DD} pins should be individually decoupled to ground. The decoupling capacitors should be placed as close as possible to the ADV7340/ADV7341 with the capacitor leads kept as short as possible to minimize lead inductance.

A 1 μF tantalum capacitor is recommended across the V_{AA} supply in addition to the 10 nF and 0.1 μF ceramic capacitors.

Power Supply Sequencing

If the ALSB pin is tied low, a power supply sequence is required for proper operation of the part. The $V_{DD_{IO}}$ power supply must be

established a minimum of 250 μs prior to the V_{DD} power supply being established. The V_{AA} and PV_{DD} power supplies can be established at any time and in any order. Tying ALSB to $V_{DD_{IO}}$ completely removes this PSS requirement.

Digital Signal Interconnect

The digital signal traces should be isolated as much as possible from the analog outputs and other analog circuitry. Digital signal traces should not overlay the V_{AA} or PV_{DD} power planes.

Due to the high clock rates used, avoid long clock traces to the ADV7340/ADV7341 to minimize noise pickup.

Any pull-up termination resistors for the digital inputs should be connected to the $V_{DD_{IO}}$ power supply.

Any unused digital inputs should be tied to ground.

Analog Signal Interconnect

DAC output traces should be treated as transmission lines with appropriate measures taken to ensure optimal performance (for example, impedance matched traces). The DAC output traces should be kept as short as possible. The termination resistors on the DAC output traces should be placed as close as possible to, and on the same side of the PCB as, the ADV7340/ADV7341.

To avoid crosstalk between the DAC outputs, it is recommended that as much space as possible be left between the traces connected to the DAC output pins. Adding ground traces between the DAC output traces is also recommended.

TYPICAL APPLICATION CIRCUIT

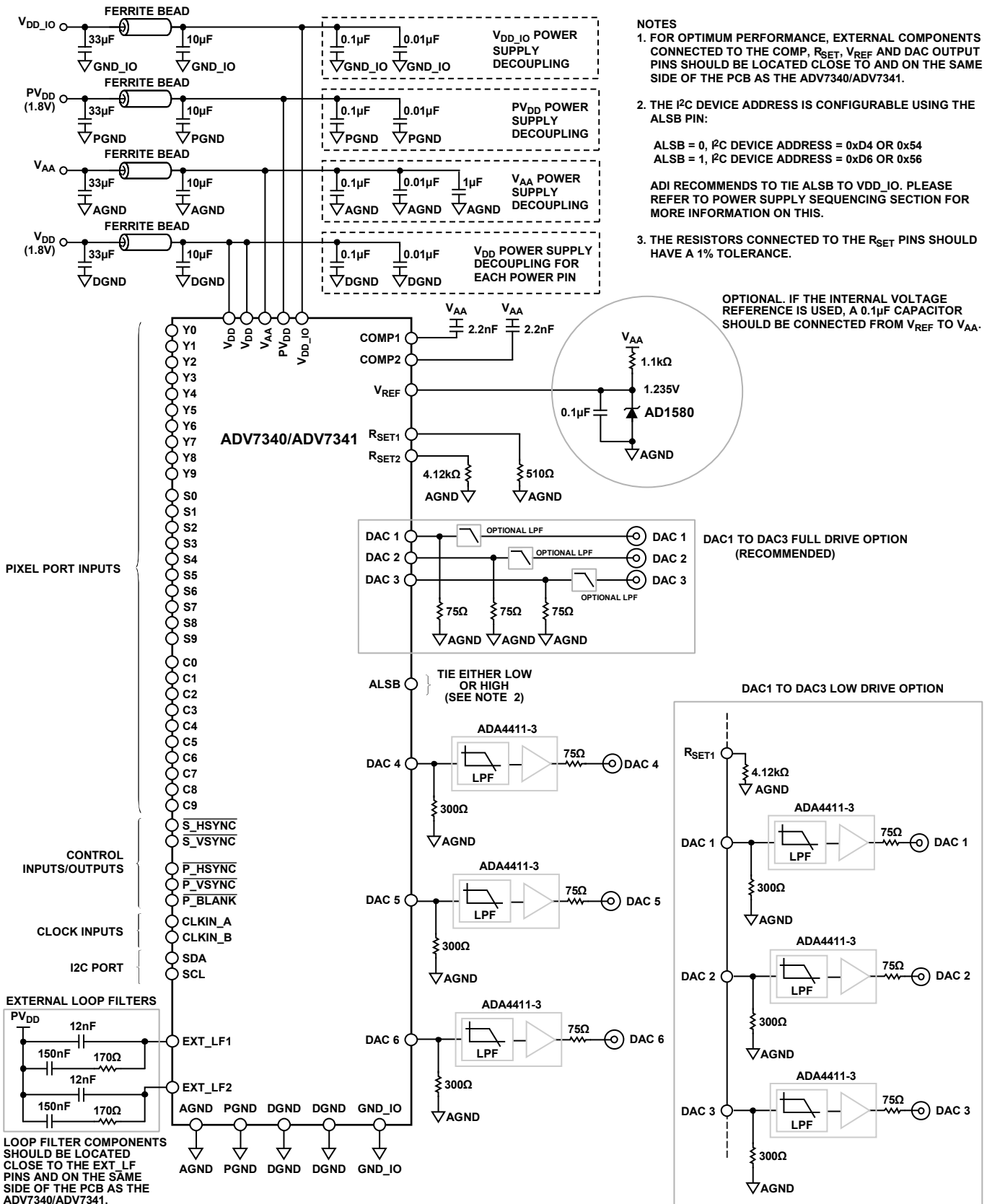

Figure 89. ADV7340/ADV7341 Typical Application Circuit

COPY GENERATION MANAGEMENT SYSTEM

SD CGMS

Subaddress 0x99 to Subaddress 0x9B

The ADV7340/ADV7341 support a copy generation management system (CGMS) conforming to the EIAJ CPR-1204 and ARIB TR-B15 standards. CGMS data is transmitted on Line 20 of odd fields and Line 283 of even fields. Subaddress 0x99, Bits[6:5] control whether CGMS data is output on odd or even fields or both.

SD CGMS data can be transmitted only when the ADV7340/ADV7341 are configured in NTSC mode. The CGMS data is 20 bits long. The CGMS data is preceded by a reference pulse of the same amplitude and duration as a CGMS bit (see Figure 90).

ED CGMS

Subaddress 0x41 to Subaddress 0x43; Subaddress 0x5E to Subaddress 0x6E

525p Mode

The ADV7340/ADV7341 support a copy generation management system (CGMS) in 525p mode in accordance with EIAJ CPR-1204-1.

When ED CGMS is enabled (Subaddress 0x32, Bit 6 = 1), 525p CGMS data is inserted on Line 41, and the 525p CGMS data registers are at Subaddress 0x41, Subaddress 0x42, and Subaddress 0x43. The ADV7340/ADV7341 also support CGMS Type B packets in 525p mode in accordance with CEA-805-A.

When ED CGMS Type B is enabled (Subaddress 0x5E, Bit 0 = 1), 525p CGMS Type B data is inserted on Line 40. The 525p CGMS Type B data registers are at Subaddress 0x5E to Subaddress 0x6E.

625p Mode

The ADV7340/ADV7341 support a copy generation management system (CGMS) in 625p mode in accordance with IEC62375 (2004).

When ED CGMS is enabled (Subaddress 0x32, Bit 6 = 1), 625p CGMS data is inserted on Line 43. The 625p CGMS data registers are at Subaddress 0x42 and Subaddress 0x43.

HD CGMS

Subaddress 0x41 to Subaddress 0x43; Subaddress 0x5E to Subaddress 0x6E

The ADV7340/ADV7341 support a copy generation management system (CGMS) in HD mode (720p and 1080i) in accordance with EIAJ CPR-1204-2.

When HD CGMS is enabled (Subaddress 0x32, Bit 6 = 1), 720p CGMS data is applied to Line 24 of the luminance vertical blanking interval.

When HD CGMS is enabled (Subaddress 0x32, Bit 6 = 1), 1080i CGMS data is applied to Line 19 and Line 582 of the luminance vertical blanking interval.

The HD CGMS data registers are at Subaddress 0x41, Subaddress 0x42, and Subaddress 0x43.

The ADV7340/ADV7341 also support CGMS Type B packets in HD mode (720p and 1080i) in accordance with CEA-805-A.

When HD CGMS Type B is enabled (Subaddress 0x5E, Bit 0 = 1), 720p CGMS data is applied to Line 23 of the luminance vertical blanking interval.

When HD CGMS Type B is enabled (Subaddress 0x5E, Bit 0 = 1), 1080i CGMS data is applied to Line 18 and Line 581 of the luminance vertical blanking interval.

The HD CGMS Type B data registers are at Subaddress 0x5E to Subaddress 0x6E.

CGMS CRC FUNCTIONALITY

If SD CGMS CRC (Subaddress 0x99, Bit 4) or ED/HD CGMS CRC (Subaddress 0x32, Bit 7) is enabled, the upper six CGMS data bits, C19 to C14, which comprise the 6-bit CRC check sequence, are automatically calculated on the ADV7340/ADV7341. This calculation is based on the lower 14 bits (C13 to C0) of the data in the CGMS data registers, and the result is output with the remaining 14 bits to form the complete 20 bits of the CGMS data. The calculation of the CRC sequence is based on the polynomial $x^6 + x + 1$ with a preset value of 111111.

If SD CGMS CRC or ED/HD CGMS CRC is disabled, all 20 bits (C19 to C0) are output directly from the CGMS registers (CRC must be calculated by the user manually).

If ED/HD CGMS Type B CRC (Subaddress 0x5E, Bit 1) is enabled, the upper six CGMS Type B data bits (P122 to P127) that comprise the 6-bit CRC check sequence are automatically calculated on the ADV7340/ADV7341. This calculation is based on the lower 128 bits (H0 to H5 and P0 to P121) of the data in the CGMS Type B data registers. The result is output with the remaining 128 bits to form the complete 134 bits of the CGMS Type B data. The calculation of the CRC sequence is based on the polynomial $x^6 + x + 1$ with a preset value of 111111.

If ED/HD CGMS Type B CRC is disabled, all 134 bits (H0 to H5 and P0 to P127) are output directly from the CGMS Type B registers (CRC must be calculated by the user manually).

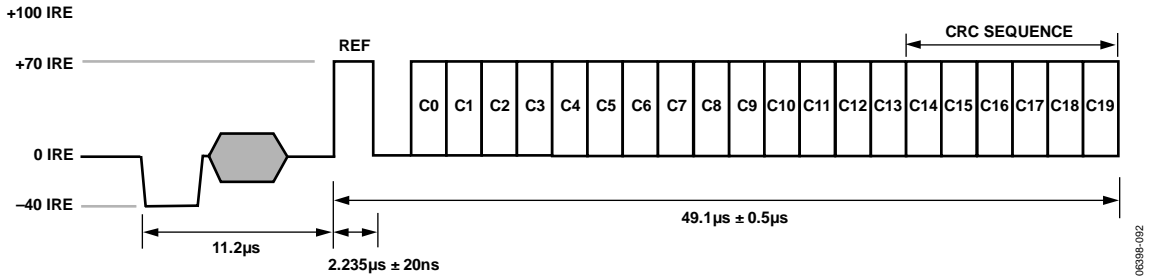

Figure 90. Standard Definition CGMS Waveform

06398-002

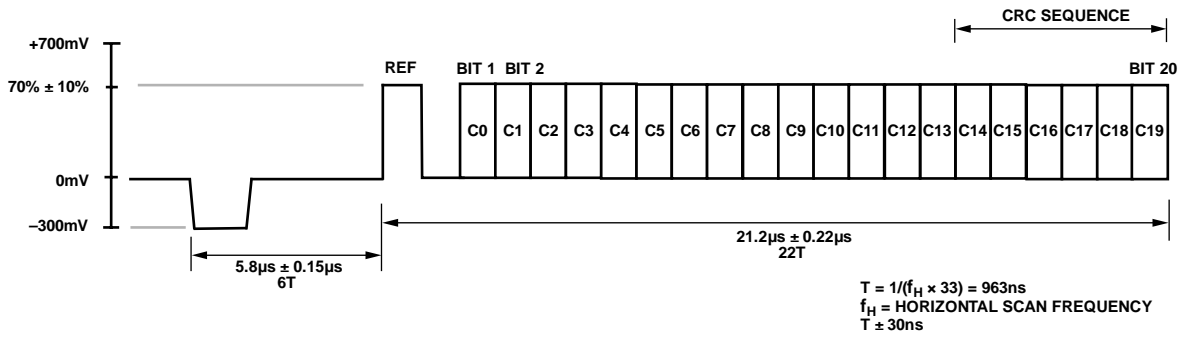

Figure 91. Enhanced Definition (525p) CGMS Waveform

06398-003

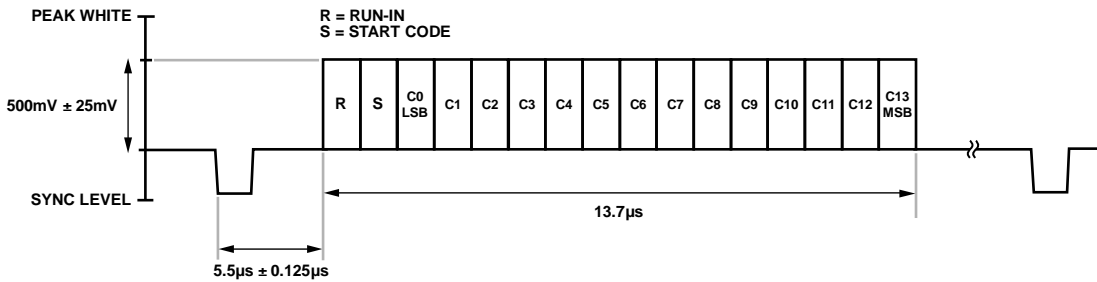

Figure 92. Enhanced Definition (625p) CGMS Waveform

06398-004

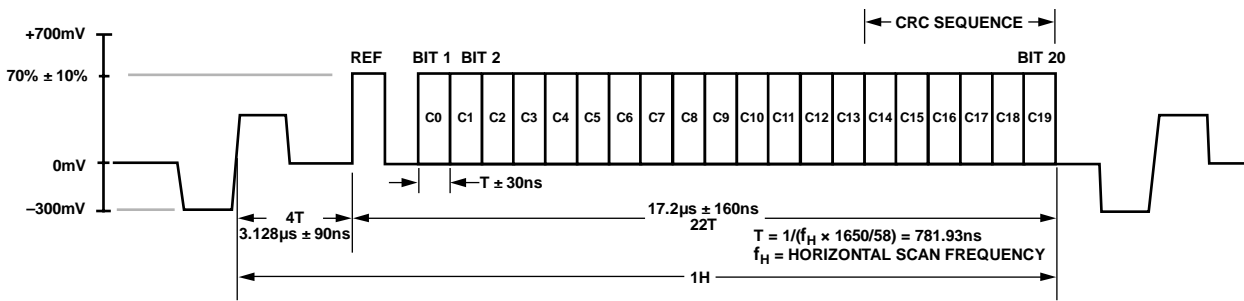

Figure 93. High Definition (720p) CGMS Waveform

06398-005

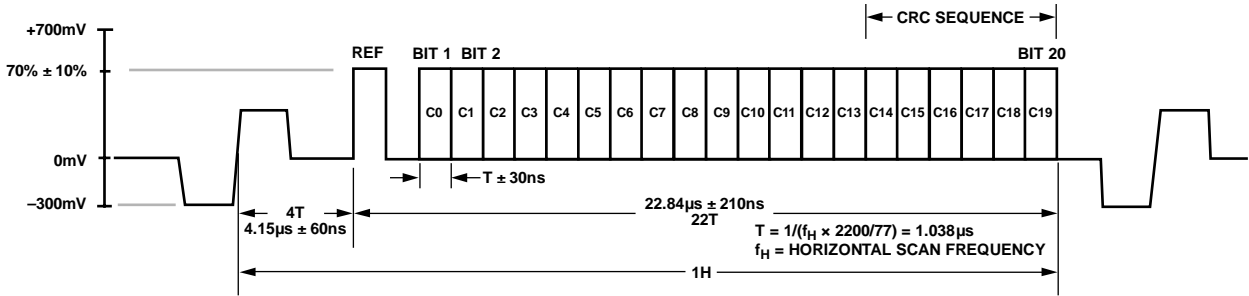
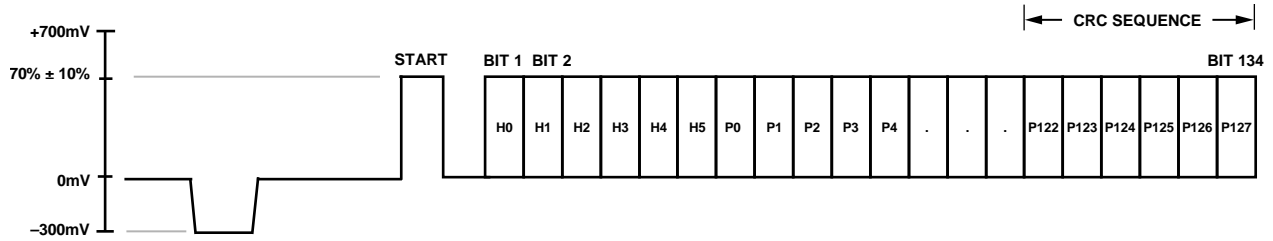

Figure 94. High Definition (1080i) CGMS Waveform

06398-006



NOTES
1. PLEASE REFER TO THE CEA-805-A SPECIFICATION FOR TIMING INFORMATION.

Figure 95. Enhanced Definition (525p) CGMS Type B Waveform

06398-007

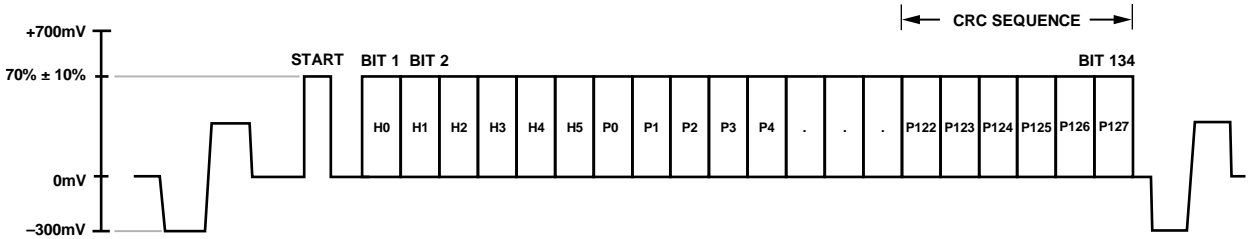

NOTES
1. PLEASE REFER TO THE CEA-805-A SPECIFICATION FOR TIMING INFORMATION.

Figure 96. High Definition (720p and 1080i) CGMS Type B Waveform

06398-008

SD WIDE SCREEN SIGNALING

Subaddress 0x99, Subaddress 0x9A, Subaddress 0x9B

The ADV7340/ADV7341 support wide screen signaling (WSS) conforming to the ETSI 300 294 standard. WSS data is transmitted on Line 23. WSS data can be transmitted only when the device is configured in PAL mode. The WSS data is 14 bits long. The function of each of these bits is shown in Table 60. The WSS data is preceded by a run-in sequence and a start code (see

Figure 97). The latter portion of Line 23 (after 42.5 μ s from the falling edge of HSYNC) is available for the insertion of video. WSS data transmission on Line 23 can be enabled using Subaddress 0x99, Bit 7. It is possible to blank the WSS portion of Line 23 with Subaddress 0xA1, Bit 7.

Table 60. Function of WSS

Bit Description	Bit Number														Setting	
	13	12	11	10	9	8	7	6	5	4	3	2	1	0		
Aspect Ratio, Format, Position												1	0	0	0	4:3, full format, N/A 14:9, letterbox, center 14:9, letterbox, top 16:9, letterbox, center 16:9, letterbox, top >16:9, letterbox, center 14:9, full format, center 16:0, N/A, N/A
Mode										0						Camera mode Film mode
Color Encoding									0	1						Normal PAL Motion Adaptive ColorPlus
Helper Signals								0	1							Not present Present
Reserved							0									N/A
Teletext Subtitles						0	1									No Yes
Open Subtitles				0	0											No Subtitles in active image area Subtitles out of active image area Reserved
Surround Sound			0	1												No Yes
Copyright		0	1													No copyright asserted or unknown Copyright asserted
Copy Protection	0	1														Copying not restricted Copying restricted

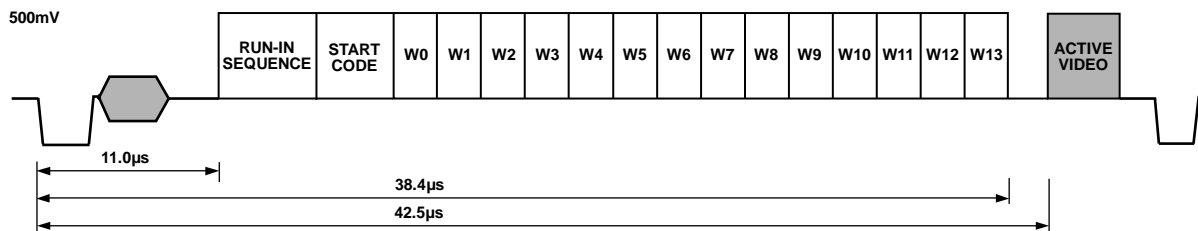

Figure 97. WSS Waveform Diagram

SD CLOSED CAPTIONING

Subaddress 0x91 to Subaddress 0x94

The ADV7340/ADV7341 support closed captioning conforming to the standard television synchronizing waveform for color transmission. Closed captioning is transmitted during the blanked active line time of Line 21 of the odd fields and Line 284 of the even fields.

Closed captioning consists of a seven-cycle sinusoidal burst that is frequency- and phase-locked to the caption data. After the clock run-in signal, the blanking level is held for two data bits and is followed by the Logic 1 start bit. Sixteen bits of data follow the start bit. These consist of two 8-bit bytes, seven data bits, and one odd parity bit. The data for these bytes is stored in the SD closed captioning registers (Subaddress 0x93 to Subaddress 0x94).

The ADV7340/ADV7341 also support the extended closed captioning operation, which is active during even fields and encoded on scan Line 284. The data for this operation is stored in the SD closed captioning registers (Subaddress 0x91 to Subaddress 0x92).

The ADV7340/ADV7341 automatically generate all clock run-in signals and timing that support closed captioning on Line 21 and Line 284. All pixels inputs are ignored on Line 21 and on Line 284 if closed captioning is enabled.

The FCC Code of Federal Regulations (CFR) 47 Section 15.119 and EIA-608 describe the closed captioning information for Line 21 and Line 284.

The ADV7340/ADV7341 use a single buffering method. This means that the closed captioning buffer is only 1-byte deep. Therefore, there is no frame delay in outputting the closed captioning data, unlike other 2-byte deep buffering systems. The data must be loaded one line before it is output on Line 21 and Line 284. A typical implementation of this method is to use \overline{VSYNC} to interrupt a microprocessor, which in turn loads the new data (two bytes) in every field. If no new data is required for transmission, 0s must be inserted in both data registers; this is called nulling. It is also important to load control codes, all of which are double bytes, on Line 21. Otherwise, a TV does not recognize them. If there is a message such as "Hello World" that has an odd number of characters, it is important to add a blank character at the end to make sure that the end-of-caption, 2-byte control code lands in the same field.

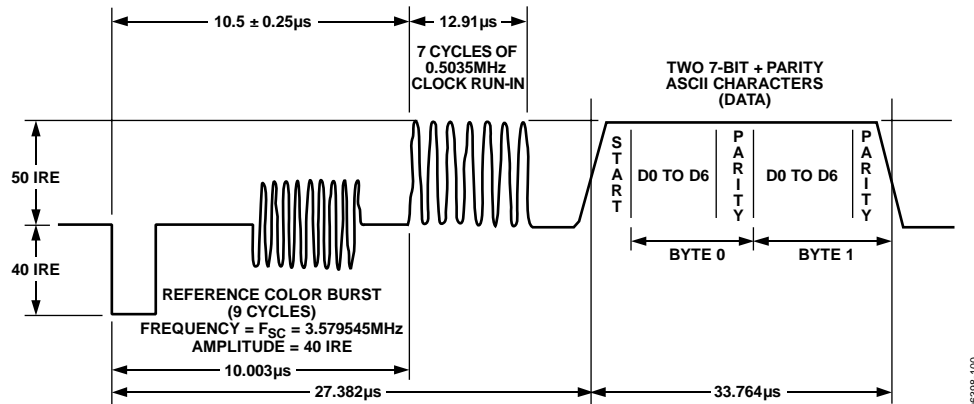

Figure 98. SD Closed Captioning Waveform, NTSC

063386-100

INTERNAL TEST PATTERN GENERATION

SD TEST PATTERNS

The ADV7340/ADV7341 are able to internally generate SD color bar and black bar test patterns. For this function, a 27 MHz clock signal must be applied to the CLKIN_A pin.

The register settings in Table 61 are used to generate an SD NTSC 75% color bar test pattern. CVBS output is available on DAC 4, S-Video (Y-C) output is on DAC 5 and DAC 6, and YPrPb output is on DAC 1 to DAC 3. On power-up, the subcarrier frequency registers default to the appropriate values for NTSC. All other registers are set as normal/default.

Table 61. SD NTSC Color Bar Test Pattern Register Writes

Subaddress	Setting
0x00	0xFC
0x82	0xC9
0x84	0x40

To generate an SD NTSC black bar test pattern, the settings shown in Table 61 should be used with an additional write of 0x24 to Subaddress 0x02.

For PAL output of either test pattern, the same settings are used, except that Subaddress 0x80 is programmed to 0x11, and the subcarrier frequency registers are programmed as shown in Table 62.

Table 62. PAL F_{sc} Register Writes

Subaddress	Description	Setting
0x8C	F _{sc0}	0xCB
0x8D	F _{sc1}	0x8A
0x8E	F _{sc2}	0x09
0x8F	F _{sc3}	0x2A

Note that, when programming the F_{sc} registers, the user must write the values in the sequence F_{sc0}, F_{sc1}, F_{sc2}, F_{sc3}. The full F_{sc} value to be written is accepted only after the F_{sc3} write is complete.

ED/HD TEST PATTERNS

The ADV7340/ADV7341 are able to internally generate an ED/HD black bar and hatch test patterns. For ED test patterns, a 27 MHz clock signal must be applied to the CLKIN_A pin. For HD test patterns, a 74.25 MHz clock signal must be applied to the CLKIN_A pin.

The register settings in Table 63 are used to generate an ED 525p hatch test pattern. YPrPb output is available on DAC 1 to DAC 3. All other registers are set as normal/default.

Table 63. ED 525p Hatch Test Pattern Register Writes

Subaddress	Setting
0x00	0x1C
0x01	0x10
0x31	0x05

To generate an ED 525p black bar test pattern, the settings shown in Table 63 should be used with an additional write of 0x24 to Subaddress 0x02.

To generate an ED 525p flat field test pattern, the settings shown in Table 63 should be used, except that 0x0D should be written to Subaddress 0x31.

The Y, Cr, and Cb levels for the hatch and flat field test patterns can be controlled using Subaddress 0x36, Subaddress 0x37, and Subaddress 0x38, respectively.

For ED/HD standards other than 525p, the settings shown in Table 63 (and subsequent comments) are used, except that Subaddress 0x30, Bits[7:3] are updated as appropriate.

SD TIMING

Mode 0 (CCIR-656)—Slave Option (Subaddress 0x8A = XXXXX000)

The ADV7340/ADV7341 are controlled by the SAV (start of active video) and EAV (end of active video) time codes embedded in the pixel data. All timing information is transmitted using a 4-byte synchronization pattern. A synchronization pattern is sent immediately before and after each line during active picture and retrace. If the S_VSYNC and S_HSYNC pins are not used, they should be tied to V_{DD_IO} during this mode.

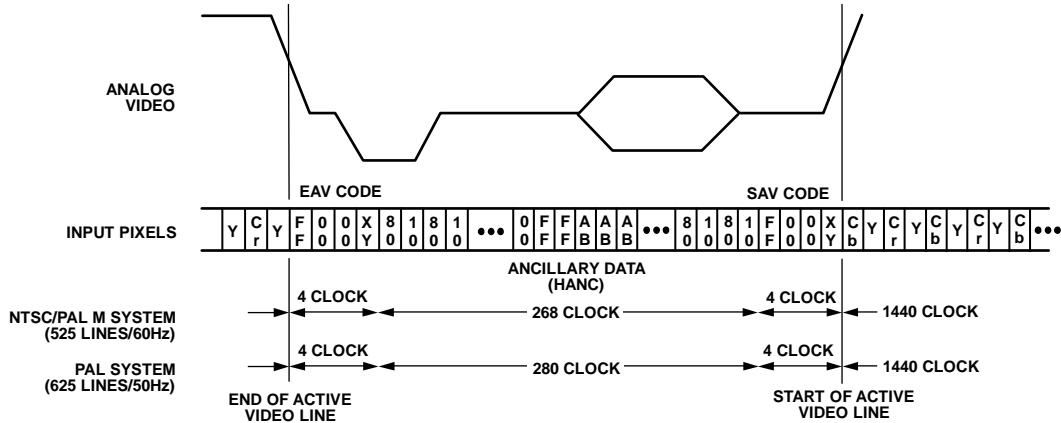

Figure 99. SD Slave Mode 0

06398-101

Mode 0 (CCIR-656)—Master Option (Subaddress 0x8A = XXXXX001)

The ADV7340/ADV7341 generate H and F signals required for the SAV and EAV time codes in the CCIR656 standard. The H bit is output on S_HSYNC and the F bit is output on S_VSYNC.

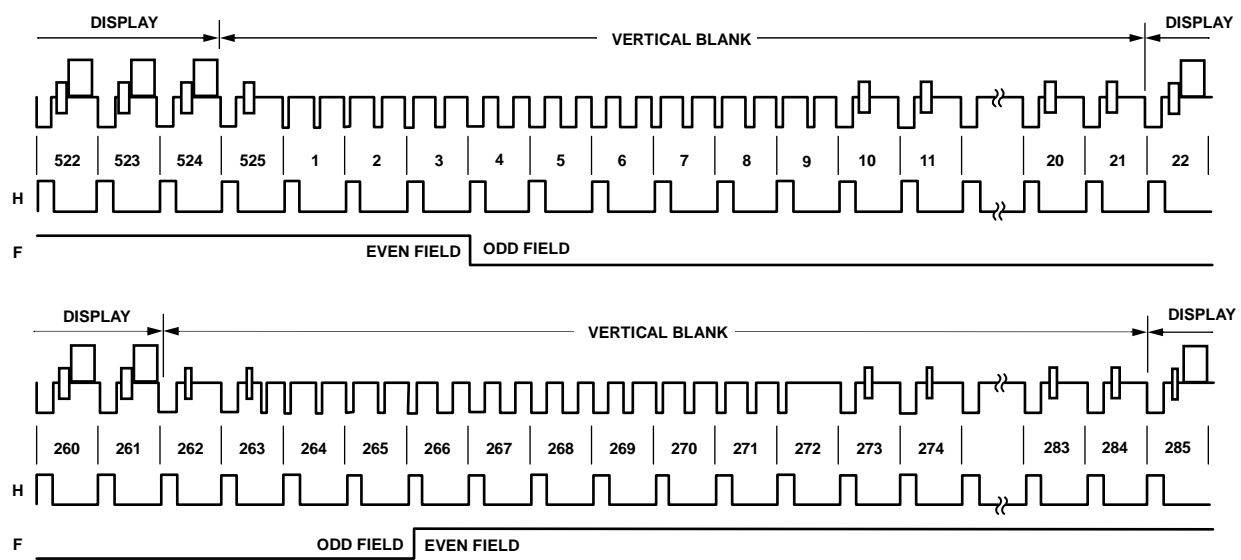

Figure 100. SD Master Mode 0, NTSC

06398-102

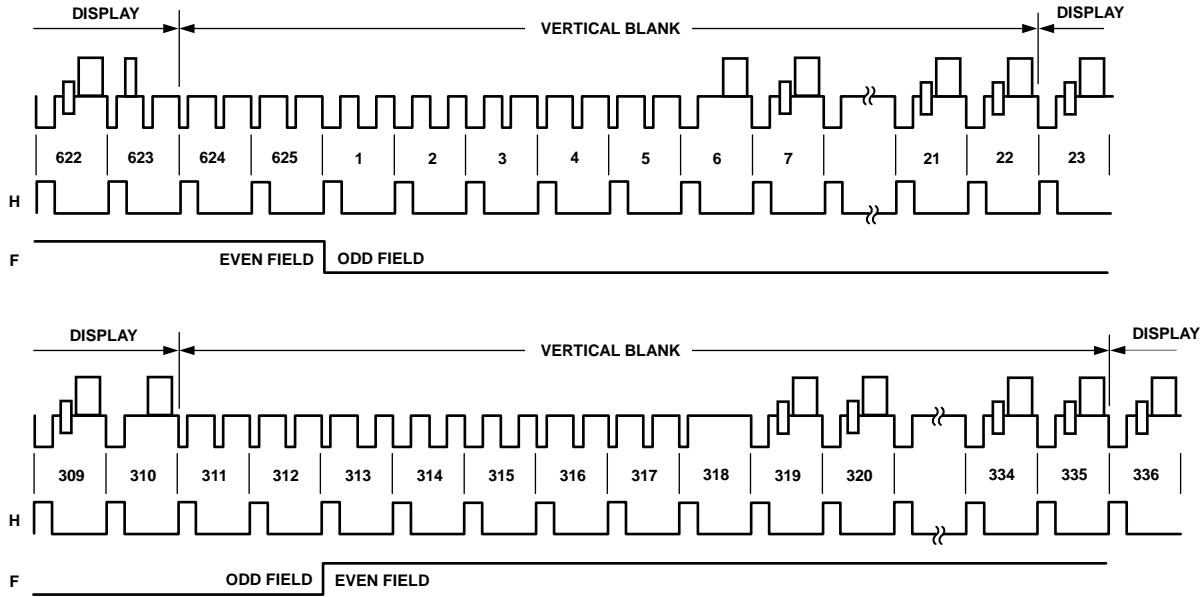

Figure 101. SD Master Mode 0, PAL

06398-103

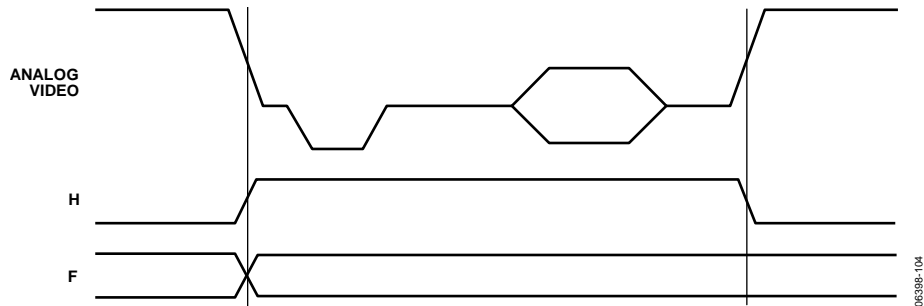

Figure 102. SD Master Mode 0, Data Transitions

06398-104

Mode 1—Slave Option (Subaddress 0x8A = XXXXX010)

In this mode, the ADV7340/ADV7341 accept horizontal sync and odd/even field signals. When $\overline{\text{HSYNC}}$ is low, a transition of the field input indicates a new frame, that is, vertical retrace. The ADV7340/ADV7341 automatically blank all normally blank lines as required by the CCIR-624 standard. $\overline{\text{HSYNC}}$ and FIELD are input on the S_HSYNC and S_VSYNC pins, respectively.

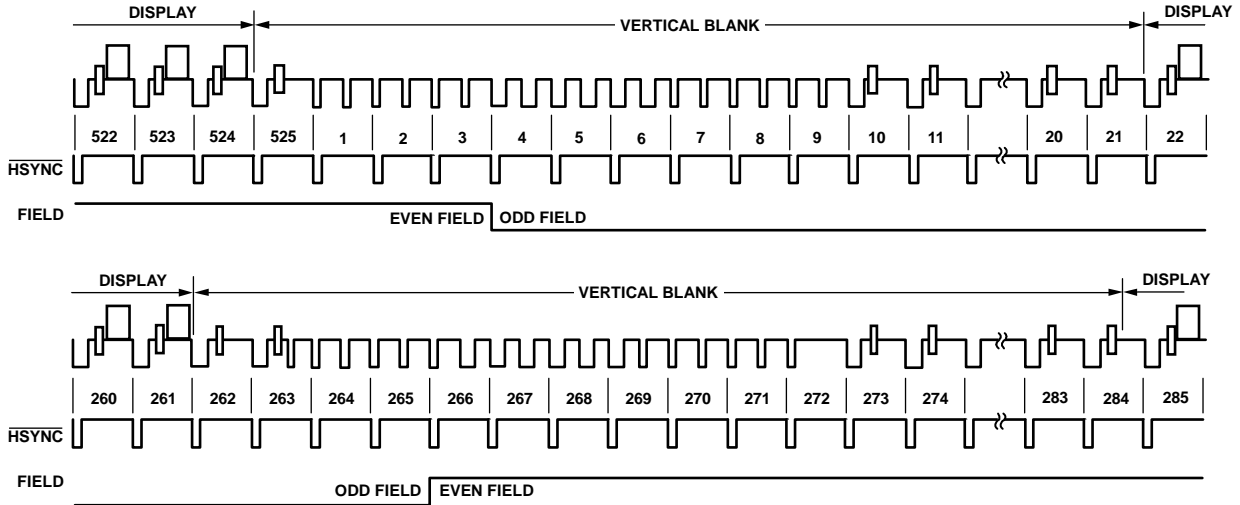

Figure 103. SD Slave Mode 1, NTSC

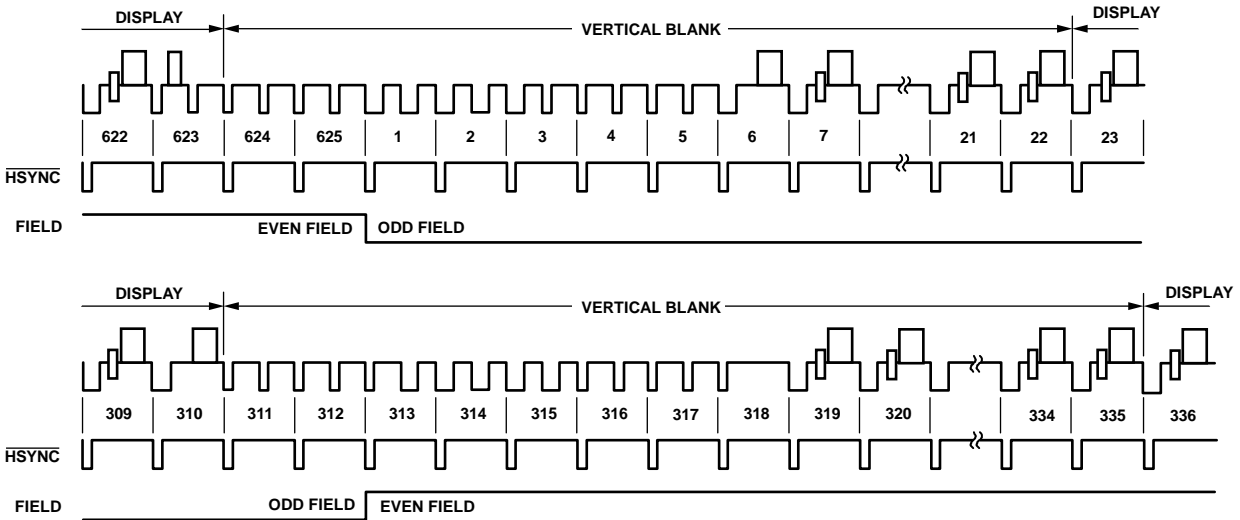

Figure 104. SD Slave Mode 1, PAL

06398-105

06398-106

Mode 1—Master Option (Subaddress 0x8A = XXXXX 0 1 1)

In this mode, the ADV7340/ADV7341 can generate horizontal sync and odd/even field signals. When $\overline{\text{HSYNC}}$ is low, a transition of the field input indicates a new frame, that is, vertical retrace. The ADV7340/ADV7341 automatically blank all normally blank lines as required by the CCIR-624 standard. Pixel data is latched on the rising clock edge following the timing signal transitions. $\overline{\text{HSYNC}}$ and FIELD are output on the S_HSYNC and S_VSYNC pins, respectively.

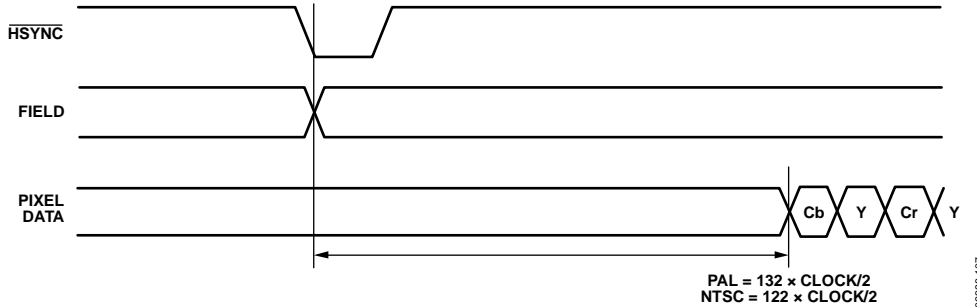

Figure 105. SD Timing Mode 1, Odd/Even Field Transitions (Master/Slave)

Mode 2— Slave Option (Subaddress 0x8A = XXXXX 1 0 0)

In this mode, the ADV7340/ADV7341 accept horizontal and vertical sync signals. A coincident low transition of both $\overline{\text{HSYNC}}$ and $\overline{\text{VSYNC}}$ inputs indicates the start of an odd field. A $\overline{\text{VSYNC}}$ low transition when $\overline{\text{HSYNC}}$ is high indicates the start of an even field. The ADV7340/ADV7341 automatically blank all normally blank lines as required by the CCIR-624 standard. $\overline{\text{HSYNC}}$ and $\overline{\text{VSYNC}}$ are input on the S_HSYNC and S_VSYNC pins, respectively.

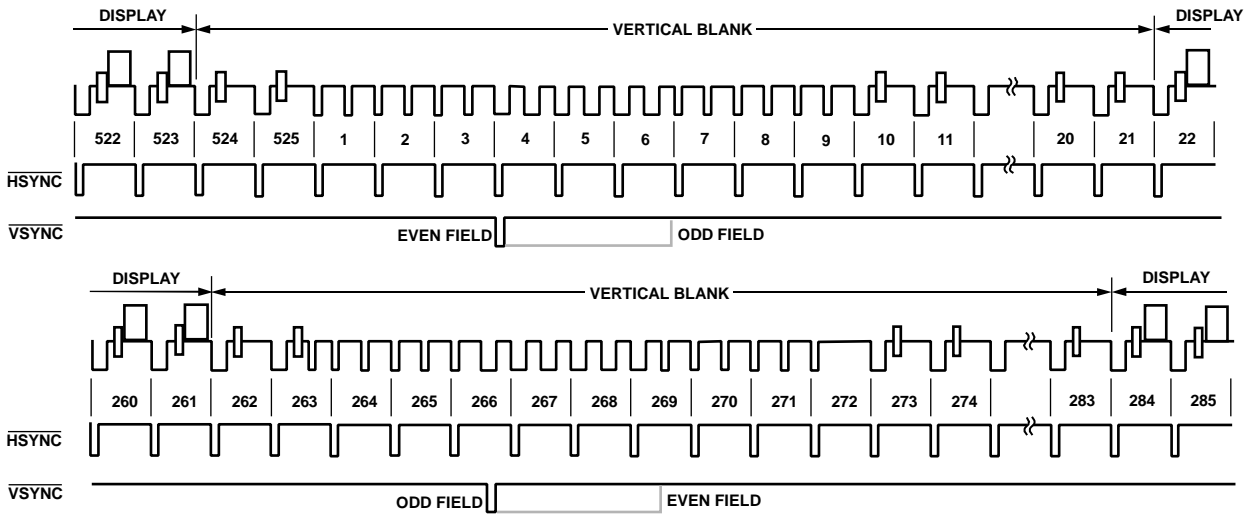

Figure 106. SD Slave Mode 2, NTSC

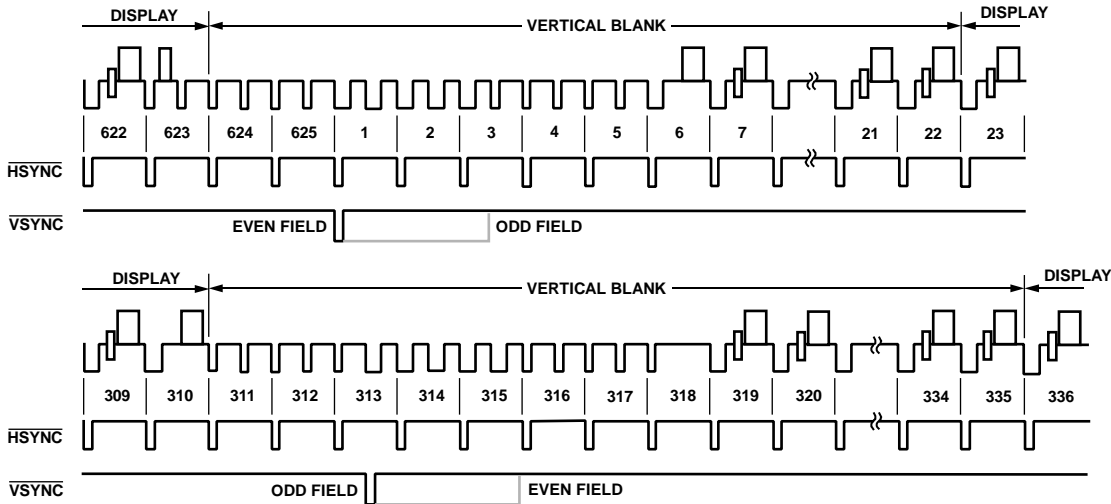

Figure 107. SD Slave Mode 2, PAL

06398-109

Mode 2—Master Option (Subaddress 0x8A = XXXXX 1 0 1)

In this mode, the ADV7340/ADV7341 can generate horizontal and vertical sync signals. A coincident low transition of both $\overline{\text{HSYNC}}$ and $\overline{\text{VSYNC}}$ inputs indicates the start of an odd field. A $\overline{\text{VSYNC}}$ low transition when $\overline{\text{HSYNC}}$ is high indicates the start of an even field. The ADV7340/ADV7341 automatically blank all normally blank lines as required by the CCIR-624 standard. $\overline{\text{HSYNC}}$ and $\overline{\text{VSYNC}}$ are output on the S_HSYNC and S_VSYNC pins, respectively.

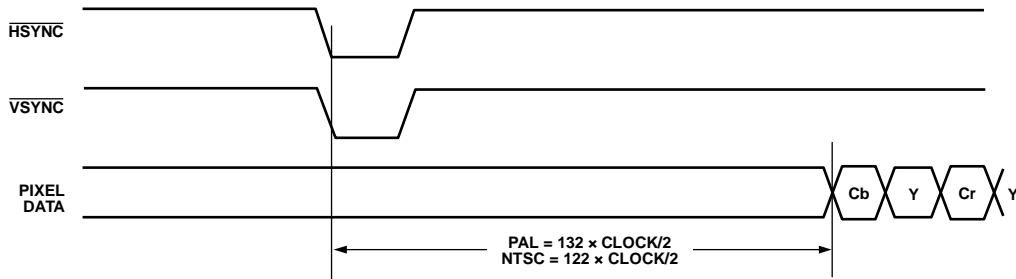

Figure 108. SD Timing Mode 2, Even-to-Odd Field Transition (Master/Slave)

06398-110

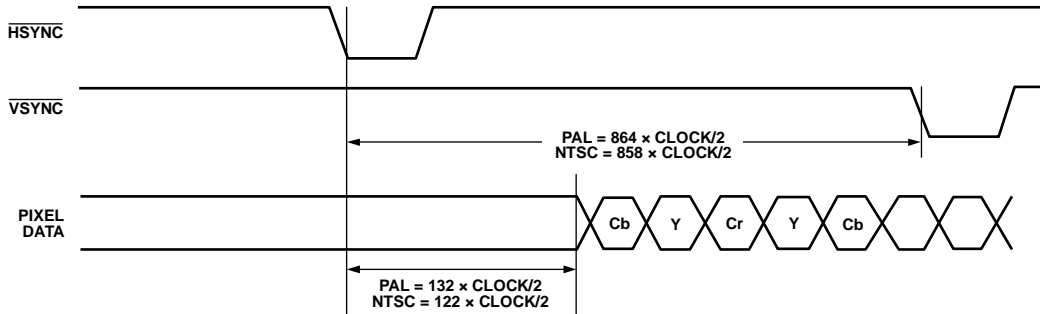

Figure 109. SD Timing Mode 2 Odd-to-Even Field Transition (Master/Slave)

06398-111

Mode 3—Master/Slave Option (Subaddress 0x8A = XXXXX 1 1 0 or XXXXX 1 1 1)

In this mode, the ADV7340/ADV7341 accept or generate horizontal sync and odd/even field signals. When $\overline{\text{HSYNC}}$ is high, a transition of the field input indicates a new frame, that is, vertical retrace. The ADV7340/ADV7341 automatically blank all normally blank lines as required by the CCIR-624 standard. $\overline{\text{HSYNC}}$ and $\overline{\text{VSYNC}}$ are output in master mode and input in slave mode on the S_VSYNC and S_VSYNC pins, respectively.

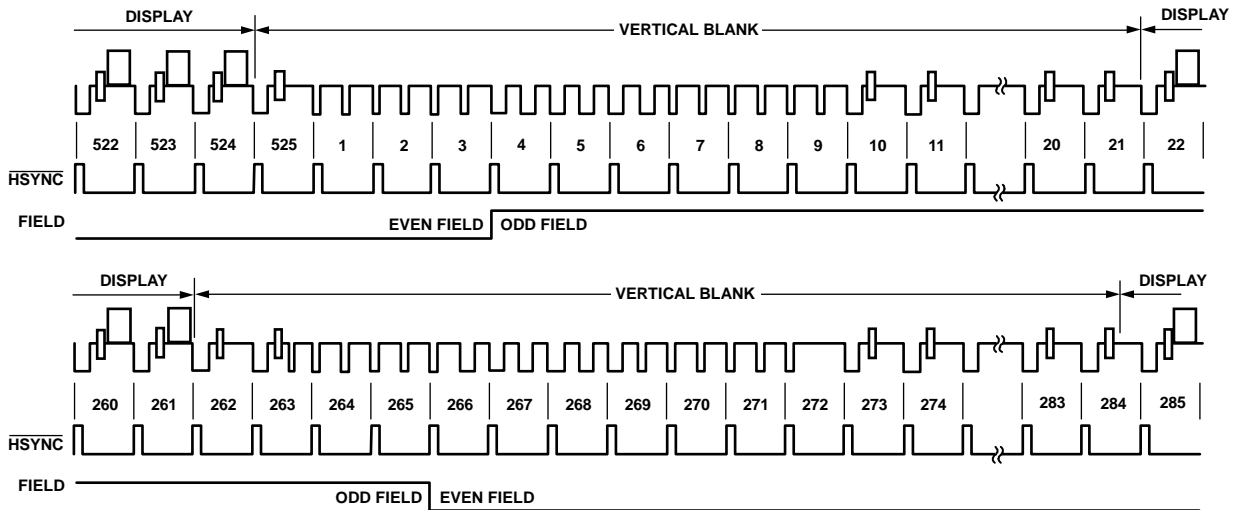

Figure 110. SD Timing Mode 3, NTSC

06398-112

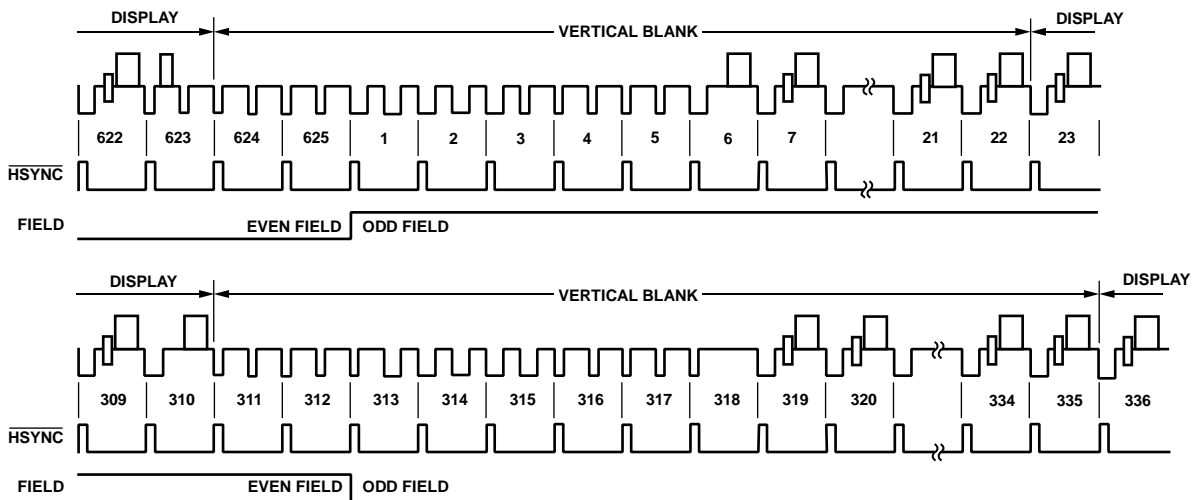

Figure 111. SD Timing Mode 3, PAL

06398-113

HD TIMING

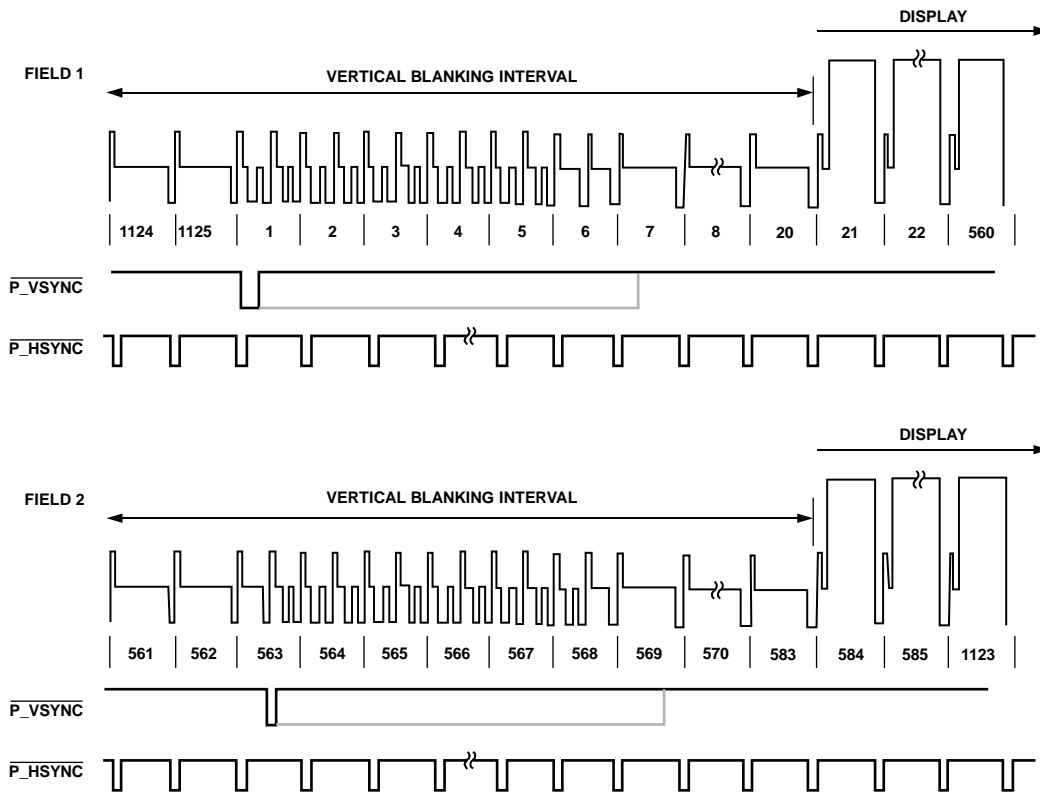

Figure 112. 1080i HSYNC and VSYNC Input Timing

06398-114

VIDEO OUTPUT LEVELS

SD YPrPb OUTPUT LEVELS—SMPTE/EBU N10

Pattern: 100% Color Bars

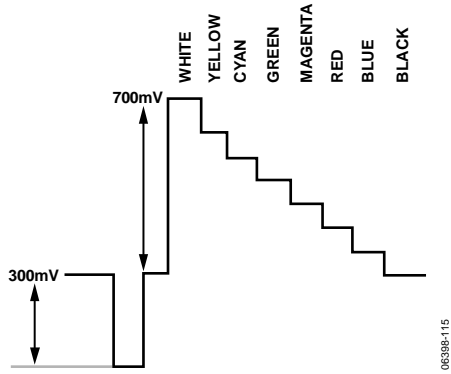

Figure 113. Y Levels—NTSC

06398-115

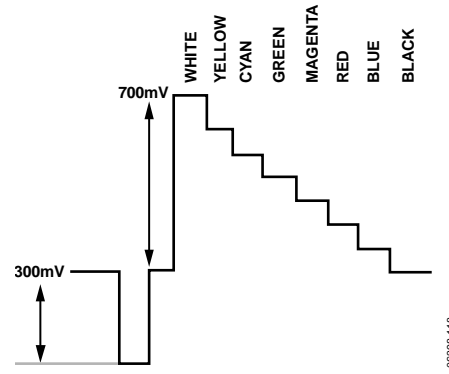

Figure 116. Y Levels—PAL

06398-118

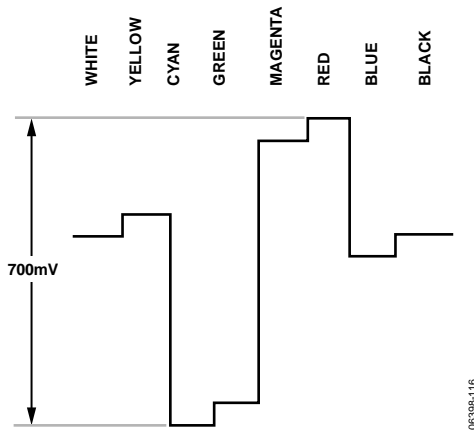

Figure 114. Pr Levels—NTSC

06398-116

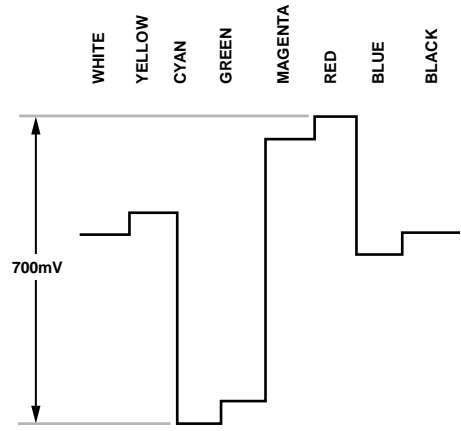

Figure 117. Pr Levels—PAL

06398-119

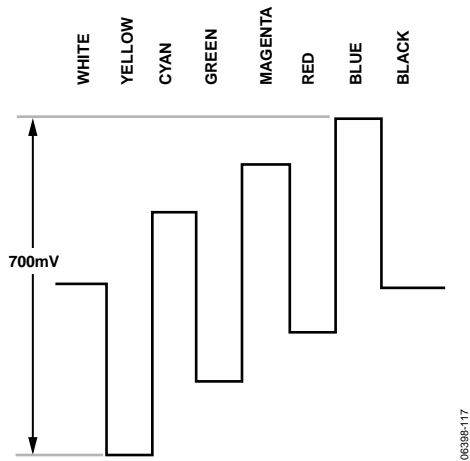

Figure 115. Pb Levels—NTSC

06398-117

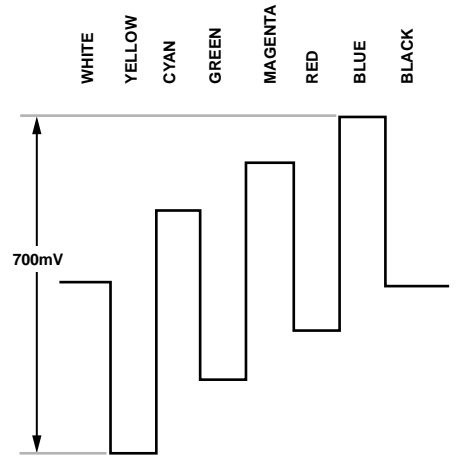

Figure 118. Pb Levels—PAL

06398-120

ED/HD YPrPb OUTPUT LEVELS

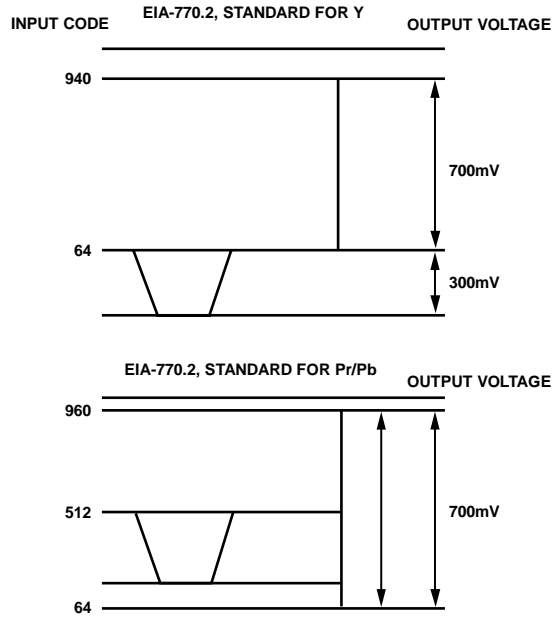

Figure 119. EIA-770.2 Standard Output Signals (525p/625p)

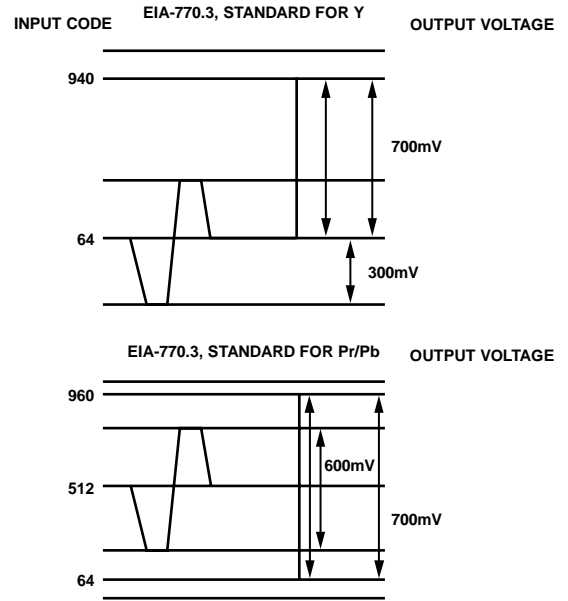

Figure 121. EIA-770.3 Standard Output Signals (1080i/720p)

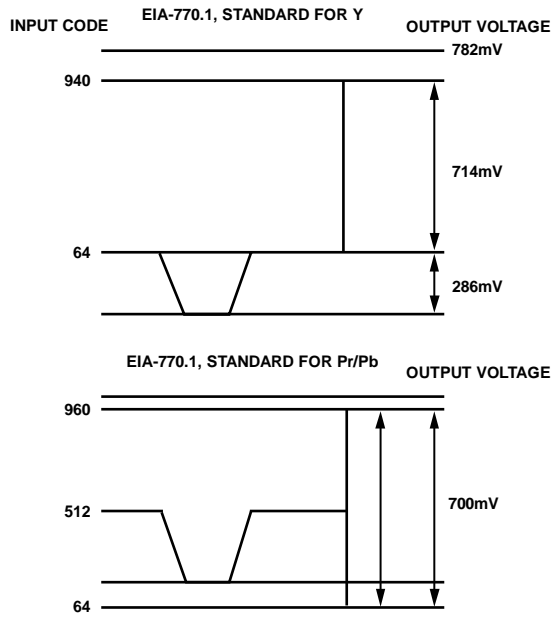

Figure 120. EIA-770.1 Standard Output Signals (525p/625p)

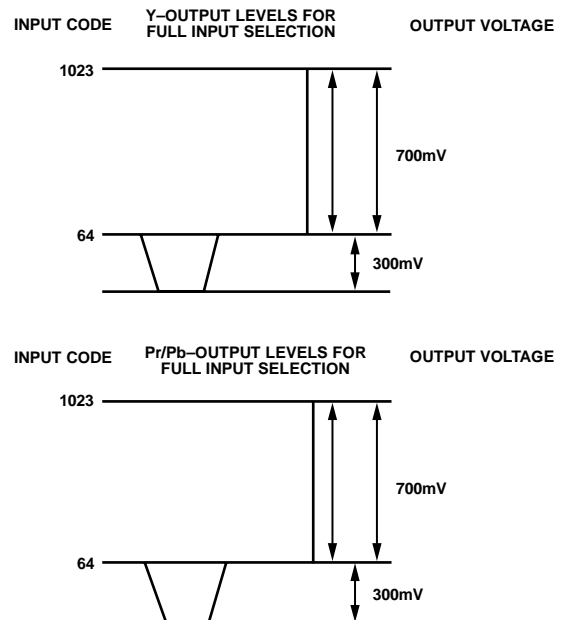

Figure 122. Output Levels for Full Input Selection

SD/ED/HD RGB OUTPUT LEVELS

Pattern: 100%/75% Color Bars

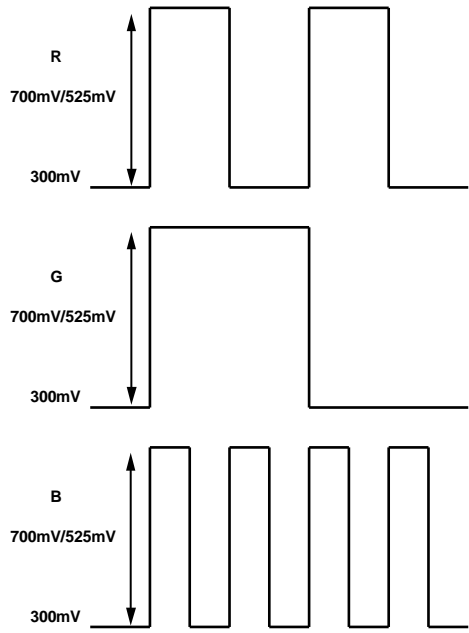

Figure 123. SD/ED RGB Output Levels—RGB Sync Disabled

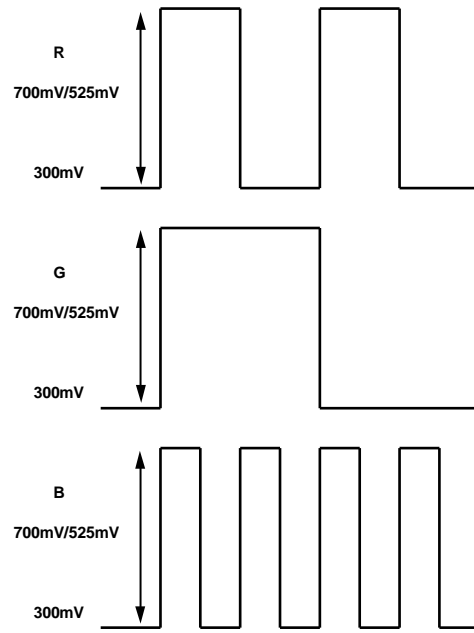

Figure 125. HD RGB Output Levels—RGB Sync Disabled

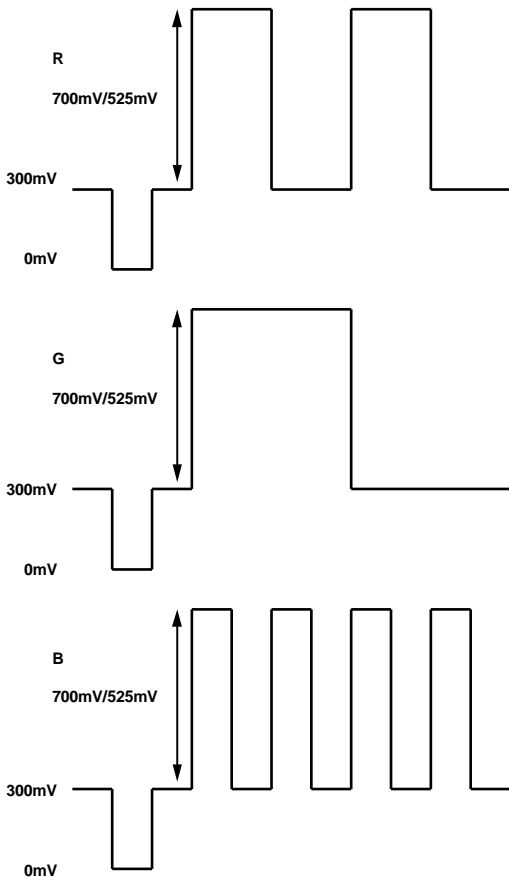

Figure 124. SD/ED RGB Output Levels—RGB Sync Enabled

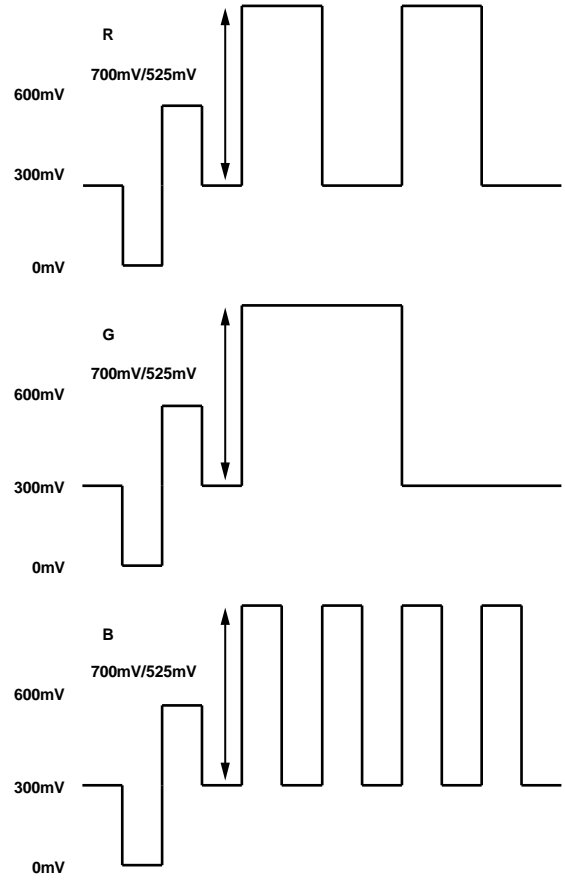

Figure 126. HD RGB Output Levels—RGB Sync Enabled

VIDEO STANDARDS

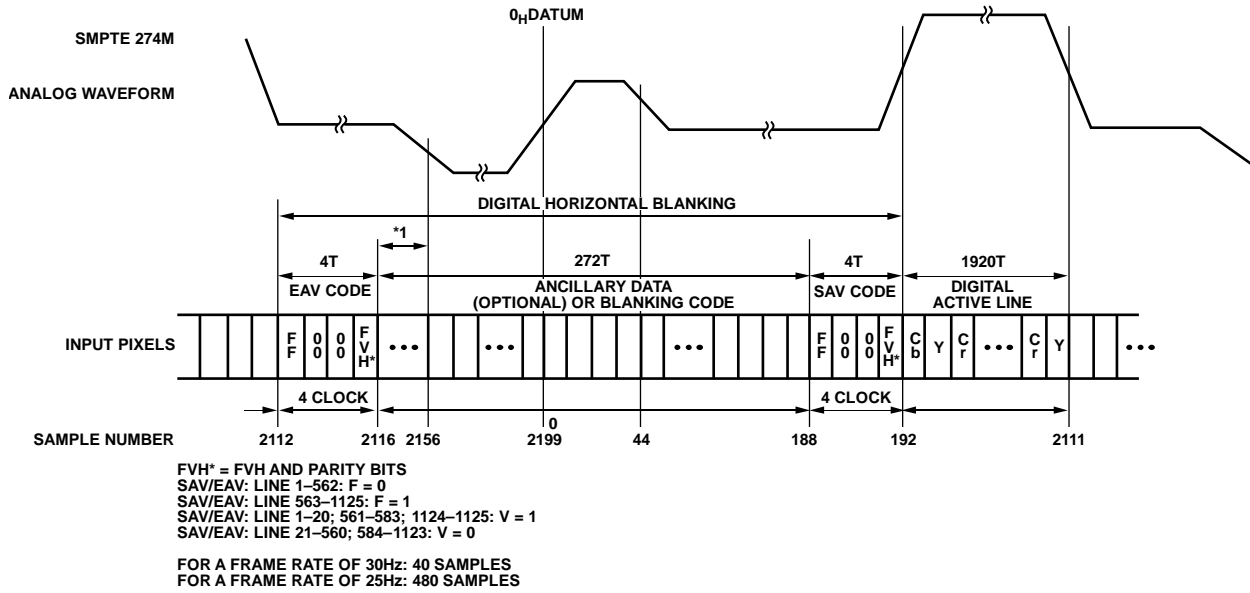

Figure 133. EAV/SAV Input Data Timing Diagram (SMPTE 274M)

063398-135

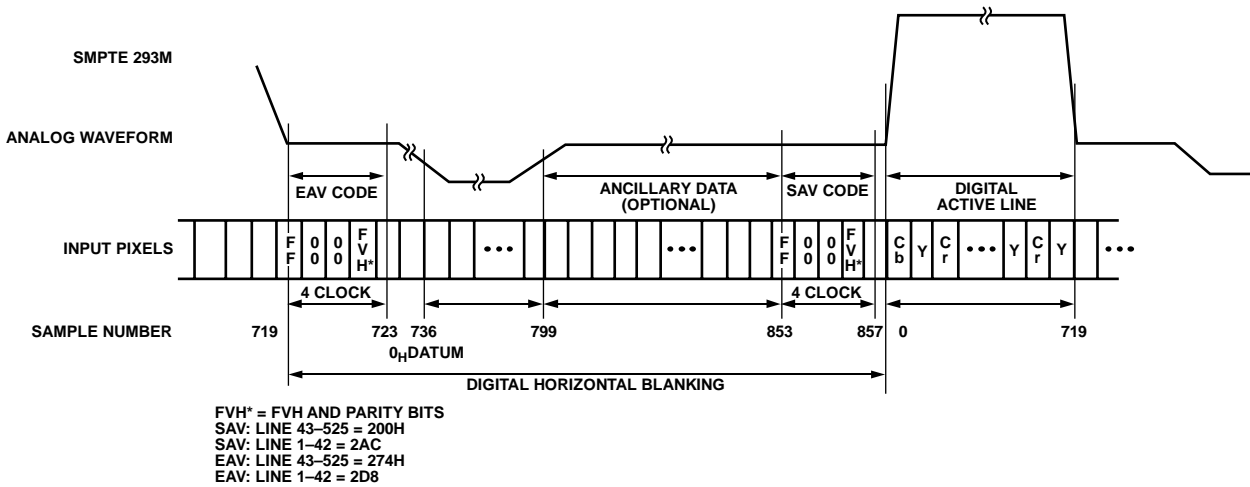

Figure 134. EAV/SAV Input Data Timing Diagram (SMPTE 293M)

063398-136

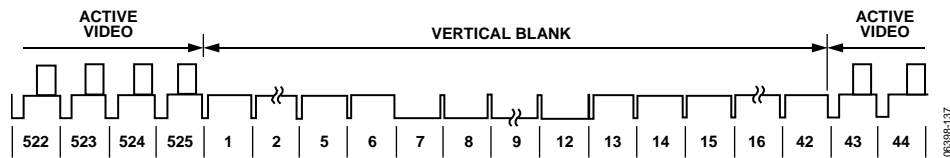

Figure 135. SMPTE 293M (525p)

063398-137

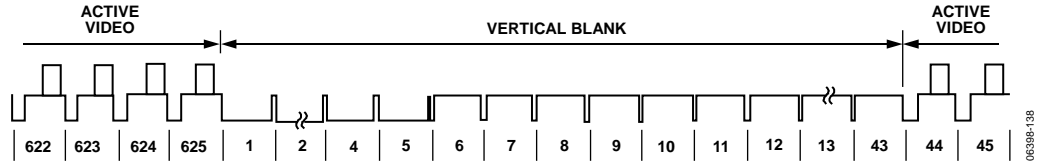

Figure 136. ITU-R BT.1358 (625p)

06398-138

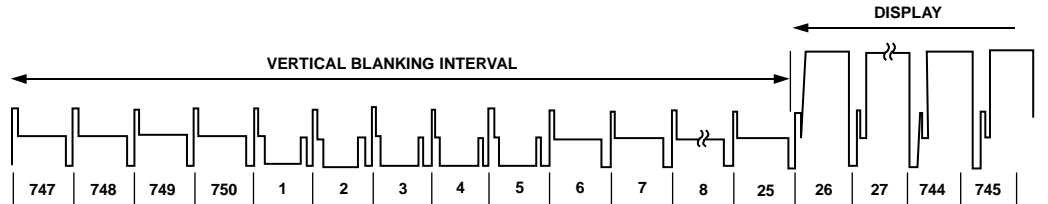

Figure 137. SMPTE 296M (720p)

06398-139

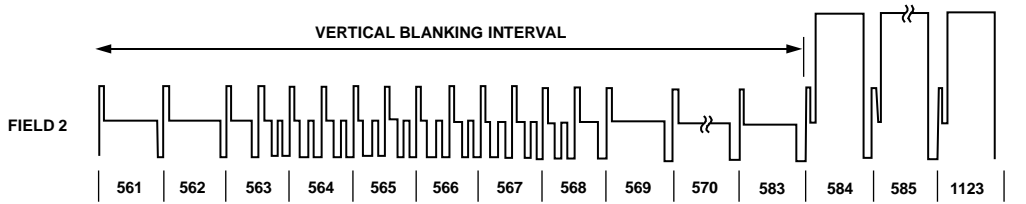
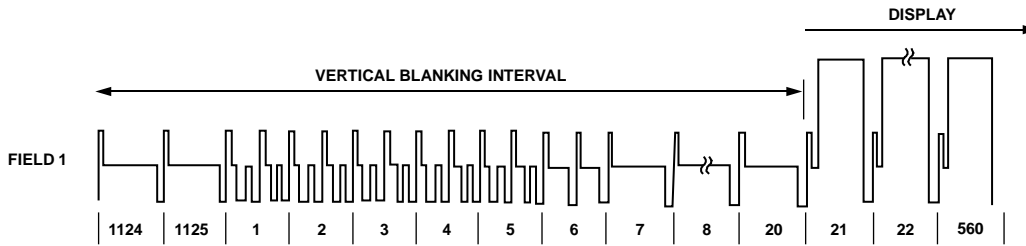

Figure 138. SMPTE 274M (1080i)

06398-140

CONFIGURATION SCRIPTS

The scripts listed in the following pages can be used to configure the ADV7340/ ADV7341 for basic operation. Certain features are enabled by default. If required for a specific application, additional features can be enabled. Table 64 lists the scripts available for SD modes of operation. Similarly, Table 85 and Table 112 list the scripts available for ED and HD modes of operation, respectively. For all scripts, only the necessary register writes are included. All other registers are assumed to have their default values.

STANDARD DEFINITION

Table 64. SD Configuration Scripts

Input Format	Input Data Width ¹	Synchronization Format	Input Color Space	Output Color Space	Table Number
525i (NTSC)	10-bit SDR	EAV/SAV	YCrCb	YPrPb and CVBS/Y-C	Table 65
525i (NTSC)	10-bit SDR	HSYNC/VSYNC	YCrCb	YPrPb and CVBS/Y-C	Table 66
525i (NTSC)	10-bit SDR	EAV/SAV	YCrCb	RGB and CVBS/Y-C	Table 67
525i (NTSC)	10-bit SDR	HSYNC/VSYNC	YCrCb	RGB and CVBS/Y-C	Table 68
525i (NTSC)	20-bit SDR	HSYNC/VSYNC	YCrCb	YPrPb and CVBS/Y-C	Table 69
525i (NTSC)	20-bit SDR	HSYNC/VSYNC	YCrCb	RGB and CVBS/Y-C	Table 70
525i (NTSC)	30-bit SDR	HSYNC/VSYNC	RGB	YPrPb and CVBS/Y-C	Table 71
525i (NTSC)	30-bit SDR	HSYNC/VSYNC	RGB	RGB and CVBS/Y-C	Table 72
NTSC Sq. Pixel	10-bit SDR	EAV/SAV	YCrCb	CVBS/Y-C (S-Video)	Table 73
NTSC Sq. Pixel	30-bit SDR	HSYNC/VSYNC	RGB	CVBS/Y-C (S-Video)	Table 74
625i (PAL)	10-bit SDR	EAV/SAV	YCrCb	YPrPb and CVBS/Y-C	Table 75
625i (PAL)	10-bit SDR	HSYNC/VSYNC	YCrCb	YPrPb and CVBS/Y-C	Table 76
625i (PAL)	10-bit SDR	EAV/SAV	YCrCb	RGB and CVBS/Y-C	Table 77
625i (PAL)	10-bit SDR	HSYNC/VSYNC	YCrCb	RGB and CVBS/Y-C	Table 78
625i (PAL)	20-bit SDR	HSYNC/VSYNC	YCrCb	YPrPb and CVBS/Y-C	Table 79
625i (PAL)	20-bit SDR	HSYNC/VSYNC	YCrCb	RGB and CVBS/Y-C	Table 80
625i (PAL)	30-bit SDR	HSYNC/VSYNC	RGB	YPrPb and CVBS/Y-C	Table 81
625i (PAL)	30-bit SDR	HSYNC/VSYNC	RGB	RGB and CVBS/Y-C	Table 82
PAL Sq. Pixel	10-bit SDR	EAV/SAV	YCrCb	CVBS/Y-C (S-Video)	Table 83
PAL Sq. Pixel	30-bit SDR	HSYNC/VSYNC	RGB	CVBS/Y-C (S-Video)	Table 84

¹ SDR = single data rate.

Table 65. 10-Bit 525i YCrCb In (EAV/SAV), YPrPb and CVBS/Y-C Out

Subaddress	Setting	Description
0x17	0x02	Software reset.
0x00	0xFC	All DACs enabled. PLL enabled (16x).
0x01	0x00	SD input mode.
0x80	0x10	NTSC standard. SSAF luma filter enabled. 1.3 MHz chroma filter enabled.
0x82	0xC9	Pixel data valid. YPrPb and CVBS/Y-C out. SSAF PrPb filter enabled. Active video edge control enabled. Pedestal enabled.
0x88	0x10	10-bit input enabled.

Table 66. 10-Bit 525i YCrCb In, YPrPb and CVBS/Y-C Out

Subaddress	Setting	Description
0x17	0x02	Software reset.
0x00	0xFC	All DACs enabled. PLL enabled (16x).
0x01	0x00	SD input mode.
0x80	0x10	NTSC standard. SSAF luma filter enabled. 1.3 MHz chroma filter enabled.
0x82	0xC9	Pixel data valid. YPrPb and CVBS/Y-C out. SSAF PrPb filter enabled. Active video edge control enabled. Pedestal enabled.
0x88	0x10	10-bit input enabled.
0x8A	0x0C	Timing Mode 2 (slave). HSYNC/VSYNC synchronization.

Table 67. 10-Bit 525i YCrCb In (EAV/SAV), RGB and CVBS/Y-C Out

Subaddress	Setting	Description
0x17	0x02	Software reset.
0x00	0xFC	All DACs enabled. PLL enabled (16x).
0x01	0x00	SD input mode.
0x02	0x10	RGB output enabled. RGB output sync enabled.
0x80	0x10	NTSC standard. SSAF luma filter enabled. 1.3 MHz chroma filter enabled.
0x82	0xC9	Pixel data valid. RGB and CVBS/Y-C out. SSAF PrPb filter enabled. Active video edge control enabled. Pedestal enabled.
0x88	0x10	10-bit input enabled.

Table 68. 10-Bit 525i YCrCb In, RGB and CVBS/Y-C Out

Subaddress	Setting	Description
0x17	0x02	Software reset.
0x00	0xFC	All DACs enabled. PLL enabled (16x).
0x01	0x00	SD input mode.
0x02	0x10	RGB output enabled. RGB output sync enabled.
0x80	0x10	NTSC standard. SSAF luma filter enabled. 1.3 MHz chroma filter enabled.
0x82	0xC9	Pixel data valid. RGB and CVBS/Y-C out. SSAF PrPb filter enabled. Active video edge control enabled. Pedestal enabled.
0x88	0x10	10-bit input enabled.
0x8A	0x0C	Timing Mode 2 (slave). HSYNC/VSYNC synchronization.

Table 69. 20-Bit 525i YCrCb In, YPrPb and CVBS/Y-C Out

Subaddress	Setting	Description
0x17	0x02	Software reset.
0x00	0xFC	All DACs enabled. PLL enabled (16x).
0x01	0x00	SD input mode.
0x80	0x10	NTSC standard. SSAF luma filter enabled. 1.3 MHz chroma filter enabled.
0x82	0xC9	Pixel data valid. YPrPb and CVBS/Y-C out. SSAF PrPb filter enabled. Active video edge control enabled. Pedestal enabled.
0x88	0x18	20-bit input enabled.
0x8A	0x0C	Timing Mode 2 (slave). HSYNC/VSYNC synchronization.

Table 70. 20-Bit 525i YCrCb In, RGB and CVBS/Y-C Out

Subaddress	Setting	Description
0x17	0x02	Software reset
0x00	0xFC	All DACs enabled. PLL enabled (16x).
0x01	0x00	SD input mode.
0x02	0x10	RGB output enabled. RGB output sync enabled.
0x80	0x10	NTSC standard. SSAF luma filter enabled. 1.3 MHz chroma filter enabled.
0x82	0xC9	Pixel data valid. RGB and CVBS/Y-C out. SSAF PrPb filter enabled. Active video edge control enabled. Pedestal enabled.
0x88	0x18	20-bit input enabled.
0x8A	0x0C	Timing Mode 2 (slave). HSYNC/VSYNC synchronization.

Table 71. 30-Bit 525i RGB In, YPrPb and CVBS/Y-C Out

Subaddress	Setting	Description
0x17	0x02	Software reset.
0x00	0xFC	All DACs enabled. PLL enabled (16x).
0x01	0x00	SD input mode.
0x80	0x10	NTSC standard. SSAF luma filter enabled. 1.3 MHz chroma filter enabled.
0x82	0xC9	Pixel data valid. YPrPb and CVBS/Y-C out. SSAF PrPb filter enabled. Active video edge control enabled. Pedestal enabled.
0x87	0x80	RGB input enabled.
0x88	0x10	10-bit input enabled (10 × 3 = 30-bit).
0x8A	0x0C	Timing Mode 2 (slave). HSYNC/VSYNC synchronization.

Table 72. 30-Bit 525i RGB In, RGB and CVBS/Y-C Out

Subaddress	Setting	Description
0x17	0x02	Software reset.
0x00	0xFC	All DACs enabled. PLL enabled (16x).
0x01	0x00	SD input mode.
0x02	0x10	RGB output enabled. RGB output sync enabled.
0x80	0x10	NTSC standard. SSAF luma filter enabled. 1.3 MHz chroma filter enabled.
0x82	0xC9	Pixel data valid. RGB and CVBS/Y-C out. SSAF PrPb filter enabled. Active video edge control enabled. Pedestal enabled.
0x87	0x80	RGB input enabled.
0x88	0x10	10-bit input enabled (10 × 3 = 30-bit).
0x8A	0x0C	Timing Mode 2 (slave). HSYNC/VSYNC synchronization.

Table 73. 10-Bit NTSC Square Pixel YCrCb In (EAV/SAV), CVBS/Y-C Out

Subaddress	Setting	Description
0x17	0x02	Software reset.
0x00	0x1C	All DACs enabled. PLL enabled (16x).
0x01	0x00	SD input mode.
0x80	0x10	NTSC standard. SSAF luma filter enabled. 1.3 MHz chroma filter enabled.
0x82	0xDB	Pixel data valid. CVBS/Y-C (S-Video) out. SSAF PrPb filter enabled. Active video edge control enabled. Pedestal enabled. Square pixel mode enabled.
0x88	0x10	10-bit YCbCr input enabled.
0x8C	0x55	Subcarrier frequency register values for CVBS and/or S-Video (Y-C) output in NTSC square pixel mode (24.5454 MHz input clock).
0x8D	0x55	
0x8E	0x55	
0x8F	0x25	

Table 74. 30-Bit NTSC Square Pixel RGB In, CVBS/Y-C Out

Subaddress	Setting	Description
0x17	0x02	Software reset.
0x00	0x1C	All DACs enabled. PLL enabled (16x).
0x01	0x00	SD input mode.
0x80	0x10	NTSC standard. SSAF luma filter enabled. 1.3 MHz chroma filter enabled.
0x82	0xDB	Pixel data valid. CVBS/Y-C (S-Video) out. SSAF PrPb filter enabled. Active video edge control enabled. Pedestal enabled. Square pixel mode enabled.
0x87	0x80	RGB input enabled.
0x88	0x10	30-bit RGB input enabled.
0x8A	0x0C	Timing Mode 2 (slave). $\overline{\text{HSYNC}}/\overline{\text{VSYNC}}$ synchronization.
0x8C	0x55	Subcarrier frequency register values for CVBS and/or S-Video (Y-C) output in NTSC square pixel mode (24.5454 MHz input clock).
0x8D	0x55	
0x8E	0x55	
0x8F	0x25	

Table 75. 10-Bit 625i YCrCb In (EAV/SAV), YPrPb and CVBS/Y-C Out

Subaddress	Setting	Description
0x17	0x02	Software reset.
0x00	0xFC	All DACs enabled. PLL enabled (16x).
0x01	0x00	SD input mode.
0x80	0x11	PAL standard. SSAF luma filter enabled. 1.3 MHz chroma filter enabled.
0x82	0xC1	Pixel data valid. YPrPb and CVBS/Y-C out. SSAF PrPb filter enabled. Active video edge control enabled.
0x88	0x10	10-bit input enabled.

Table 76. 10-Bit 625i YCrCb In, YPrPb and CVBS/Y-C Out

Subaddress	Setting	Description
0x17	0x02	Software reset.
0x00	0xFC	All DACs enabled. PLL enabled (16x).
0x01	0x00	SD input mode.
0x80	0x11	PAL standard. SSAF luma filter enabled. 1.3 MHz chroma filter enabled.
0x82	0xC1	Pixel data valid. YPrPb and CVBS/Y-C out. SSAF PrPb filter enabled. Active video edge control enabled.
0x88	0x10	10-bit input enabled.
0x8A	0x0C	Timing Mode 2 (slave). $\overline{\text{HSYNC}}/\overline{\text{VSYNC}}$ synchronization.

Table 77. 10-Bit 625i YCrCb In (EAV/SAV), RGB and CVBS/Y-C Out

Subaddress	Setting	Description
0x17	0x02	Software reset.
0x00	0xFC	All DACs enabled. PLL enabled (16x).
0x01	0x00	SD input mode.
0x02	0x10	RGB output enabled. RGB output sync enabled.
0x80	0x11	PAL standard. SSAF luma filter enabled. 1.3 MHz chroma filter enabled.
0x82	0xC1	Pixel data valid. RGB and CVBS/Y-C out. SSAF PrPb filter enabled. Active video edge control enabled.
0x88	0x10	10-bit input enabled.

Table 78. 10-Bit 625i YCrCb In, RGB and CVBS/Y-C Out

Subaddress	Setting	Description
0x17	0x02	Software reset.
0x00	0xFC	All DACs enabled. PLL enabled (16x).
0x01	0x00	SD input mode.
0x02	0x10	RGB output enabled. RGB output sync enabled.
0x80	0x11	PAL standard. SSAF luma filter enabled. 1.3 MHz chroma filter enabled.
0x82	0xC1	Pixel data valid. RGB and CVBS/Y-C out. SSAF PrPb filter enabled. Active video edge control enabled.
0x88	0x10	10-bit input enabled.
0x8A	0x0C	Timing Mode 2 (slave). $\overline{\text{HSYNC}}/\overline{\text{VSYNC}}$ synchronization.

Table 79. 20-Bit 625i YCrCb In, YPrPb and CVBS/Y-C Out

Subaddress	Setting	Description
0x17	0x02	Software reset.
0x00	0xFC	All DACs enabled. PLL enabled (16×).
0x01	0x00	SD input mode.
0x80	0x11	PAL standard. SSAF luma filter enabled. 1.3 MHz chroma filter enabled.
0x82	0xC1	Pixel data valid. YPrPb and CVBS/Y-C out. SSAF PrPb filter enabled. Active video edge control enabled.
0x88	0x18	20-bit input enabled.
0x8A	0x0C	Timing Mode 2 (slave). HSYNC/VSYNC synchronization.

Table 80. 20-Bit 625i YCrCb In, RGB and CVBS/Y-C Out

Subaddress	Setting	Description
0x17	0x02	Software reset.
0x00	0xFC	All DACs enabled. PLL enabled (16×).
0x01	0x00	SD input mode.
0x02	0x10	RGB output enabled. RGB output sync enabled.
0x80	0x11	PAL standard. SSAF luma filter enabled. 1.3 MHz chroma filter enabled.
0x82	0xC1	Pixel data valid. RGB and CVBS/Y-C out. SSAF PrPb filter enabled. Active video edge control enabled.
0x88	0x18	20-bit input enabled.
0x8A	0x0C	Timing Mode 2 (slave). HSYNC/VSYNC synchronization.

Table 81. 30-Bit 625i RGB In, YPrPb and CVBS/Y-C Out

Subaddress	Setting	Description
0x17	0x02	Software reset.
0x00	0xFC	All DACs enabled. PLL enabled (16×).
0x01	0x00	SD input mode.
0x80	0x11	PAL standard. SSAF luma filter enabled. 1.3 MHz chroma filter enabled.
0x82	0xC1	Pixel data valid. YPrPb and CVBS/Y-C out. SSAF PrPb filter enabled. Active video edge control enabled.
0x87	0x80	RGB input enabled.
0x88	0x10	10-bit input enabled (10 × 3 = 30-bit).
0x8A	0x0C	Timing Mode 2 (slave). HSYNC/VSYNC synchronization.

Table 82. 30-Bit 625i RGB In, RGB and CVBS/Y-C Out

Subaddress	Setting	Description
0x17	0x02	Software reset.
0x00	0xFC	All DACs enabled. PLL enabled (16×).
0x01	0x00	SD input mode.
0x02	0x10	RGB output enabled. RGB output sync enabled.
0x80	0x11	PAL standard. SSAF luma filter enabled. 1.3 MHz chroma filter enabled.
0x82	0xC1	Pixel data valid. RGB and CVBS/Y-C out. SSAF PrPb filter enabled. Active video edge control enabled.
0x87	0x80	RGB input enabled.
0x88	0x10	10-bit input enabled (10 × 3 = 30-bit).
0x8A	0x0C	Timing Mode 2 (slave). HSYNC/VSYNC synchronization.

Table 83. 10-Bit PAL Square Pixel YCrCb In (EAV/SAV), CVBS/Y-C Out

Subaddress	Setting	Description
0x17	0x02	Software reset.
0x00	0x1C	All DACs enabled. PLL enabled (16×).
0x01	0x00	SD input mode.
0x80	0x11	PAL standard. SSAF luma filter enabled. 1.3 MHz chroma filter enabled.
0x82	0xD3	Pixel data valid. CVBS/Y-C (S-Video) out. SSAF PrPb filter enabled. Active video edge control enabled. Square pixel mode enabled.
0x88	0x10	10-bit YCbCr input enabled.
0x8C	0x0C	Subcarrier frequency register values for CVBS and/or S-Video (Y-C) output in PAL square pixel mode (29.5 MHz input clock).
0x8D	0x8C	
0x8E	0x79	
0x8F	0x26	

Table 84. 30-Bit PAL Square Pixel RGB In, CVBS/Y-C Out

Subaddress	Setting	Description
0x17	0x02	Software reset.
0x00	0x1C	All DACs enabled. PLL enabled (16×).
0x01	0x00	SD input mode.
0x80	0x11	PAL standard. SSAF luma filter enabled. 1.3 MHz chroma filter enabled.
0x82	0xD3	Pixel data valid. CVBS/Y-C (S-Video) out. SSAF PrPb filter enabled. Active video edge control enabled. Square pixel mode enabled.
0x87	0x80	RGB input enabled.
0x88	0x10	30-bit RGB input enabled.
0x8A	0x0C	Timing Mode 2 (slave). HSYNC/VSYNC synchronization.
0x8C	0x0C	Subcarrier frequency register values for CVBS and/or S-Video (Y-C) output in PAL square pixel mode (29.5 MHz input clock).
0x8D	0x8C	
0x8E	0x79	
0x8F	0x26	

ENHANCED DEFINITION

Table 85. ED Configuration Scripts

Input Format	Input Data Width ¹	Synchronization Format	Input Color Space	Output Color Space	Table Number
525p at 59.94 Hz	10-bit DDR	EAV/SAV	YCrCb	YPrPb	Table 86
525p at 59.94 Hz	10-bit DDR	HSYNC/VSYNC	YCrCb	YPrPb	Table 87
525p at 59.94 Hz	10-bit DDR	EAV/SAV	YCrCb	RGB	Table 88
525p at 59.94 Hz	10-bit DDR	HSYNC/VSYNC	YCrCb	RGB	Table 89
525p at 59.94 Hz	20-bit SDR	EAV/SAV	YCrCb	YPrPb	Table 90
525p at 59.94 Hz	20-bit SDR	HSYNC/VSYNC	YCrCb	YPrPb	Table 91
525p at 59.94 Hz	20-bit SDR	EAV/SAV	YCrCb	RGB	Table 92
525p at 59.94 Hz	20-bit SDR	HSYNC/VSYNC	YCrCb	RGB	Table 93
525p at 59.94 Hz	30-bit SDR	EAV/SAV	YCrCb	YPrPb	Table 94
525p at 59.94 Hz	30-bit SDR	HSYNC/VSYNC	YCrCb	YPrPb	Table 95
525p at 59.94 Hz	30-bit SDR	EAV/SAV	YCrCb	RGB	Table 96
525p at 59.94 Hz	30-bit SDR	HSYNC/VSYNC	YCrCb	RGB	Table 97
525p at 59.94 Hz	30-bit SDR	HSYNC/VSYNC	RGB	RGB	Table 98
625p at 50 Hz	10-bit DDR	EAV/SAV	YCrCb	YPrPb	Table 99
625p at 50 Hz	10-bit DDR	HSYNC/VSYNC	YCrCb	YPrPb	Table 100
625p at 50 Hz	10-bit DDR	EAV/SAV	YCrCb	RGB	Table 101
625p at 50 Hz	10-bit DDR	HSYNC/VSYNC	YCrCb	RGB	Table 102
625p at 50 Hz	20-bit SDR	EAV/SAV	YCrCb	YPrPb	Table 103
625p at 50 Hz	20-bit SDR	HSYNC/VSYNC	YCrCb	YPrPb	Table 104
625p at 50 Hz	20-bit SDR	EAV/SAV	YCrCb	RGB	Table 105
625p at 50 Hz	20-bit SDR	HSYNC/VSYNC	YCrCb	RGB	Table 106
625p at 50 Hz	30-bit SDR	EAV/SAV	YCrCb	YPrPb	Table 107
625p at 50 Hz	30-bit SDR	HSYNC/VSYNC	YCrCb	YPrPb	Table 108
625p at 50 Hz	30-bit SDR	EAV/SAV	YCrCb	RGB	Table 109
625p at 50 Hz	30-bit SDR	HSYNC/VSYNC	YCrCb	RGB	Table 110
625p at 50 Hz	30-bit SDR	HSYNC/VSYNC	RGB	RGB	Table 111

¹ SDR = single data rate. DDR = dual data rate.

Table 86. 10-Bit 525p YCrCb In (EAV/SAV), YPrPb Out

Subaddress	Setting	Description
0x17	0x02	Software reset.
0x00	0x1C	All DACs enabled. PLL enabled (8x).
0x01	0x20	ED-DDR input mode. Luma data clocked on falling edge of CLKIN.
0x30	0x04	525p at 59.94 Hz. EAV/SAV synchronization. EIA-770.2 output levels.
0x31	0x01	Pixel data valid.
0x33	0x6C	10-bit input enabled.

Table 87. 10-Bit 525p YCrCb In, YPrPb Out

Subaddress	Setting	Description
0x17	0x02	Software reset.
0x00	0x1C	All DACs enabled. PLL enabled (8x).
0x01	0x20	ED-DDR input mode. Luma data clocked on falling edge of CLKIN.
0x30	0x00	525p at 59.94 Hz. HSYNC/VSYNC synchronization. EIA-770.2 output levels.
0x31	0x01	Pixel data valid.
0x33	0x6C	10-bit input enabled.

Table 88. 10-Bit 525p YCrCb In (EAV/SAV), RGB Out

Subaddress	Setting	Description
0x17	0x02	Software reset.
0x00	0x1C	All DACs enabled. PLL enabled (8×).
0x01	0x20	ED-DDR input mode. Luma data clocked on falling edge of CLKIN.
0x02	0x10	RGB output enabled. RGB output sync enabled.
0x30	0x04	525p at 59.94 Hz. EAV/SAV synchronization. EIA-770.2 output levels.
0x31	0x01	Pixel data valid.
0x33	0x6C	10-bit input enabled.

Table 89. 10-Bit 525p YCrCb In, RGB Out

Subaddress	Setting	Description
0x17	0x02	Software reset.
0x00	0x1C	All DACs enabled. PLL enabled (8×).
0x01	0x20	ED-DDR input mode. Luma data clocked on falling edge of CLKIN.
0x02	0x10	RGB output enabled. RGB output sync enabled.
0x30	0x00	525p at 59.94 Hz. HSYNC/VSYNC synchronization. EIA-770.2 output levels.
0x31	0x01	Pixel data valid.
0x33	0x6C	10-bit input enabled.

Table 90. 20-Bit 525p YCrCb In (EAV/SAV), YPrPb Out

Subaddress	Setting	Description
0x17	0x02	Software reset.
0x00	0x1C	All DACs enabled. PLL enabled (8×).
0x01	0x10	ED-SDR input mode.
0x30	0x04	525p at 59.94 Hz. EAV/SAV synchronization. EIA-770.2 output levels.
0x31	0x01	Pixel data valid.
0x33	0x6C	10-bit input enabled (10 × 2 = 20-bit).

Table 91. 20-Bit 525p YCrCb In, YPrPb Out

Subaddress	Setting	Description
0x17	0x02	Software reset.
0x00	0x1C	All DACs enabled. PLL enabled (8×).
0x01	0x10	ED-SDR input mode.
0x30	0x00	525p at 59.94 Hz. HSYNC/VSYNC synchronization. EIA-770.2 output levels.
0x31	0x01	Pixel data valid.
0x33	0x6C	10-bit input enabled (10 × 2 = 20-bit).

Table 92. 20-Bit 525p YCrCb In (EAV/SAV), RGB Out

Subaddress	Setting	Description
0x17	0x02	Software reset.
0x00	0x1C	All DACs enabled. PLL enabled (8×).
0x01	0x10	ED-SDR input mode.
0x02	0x10	RGB output enabled. RGB output sync enabled.
0x30	0x04	525p at 59.94 Hz. EAV/SAV synchronization. EIA-770.2 output levels.
0x31	0x01	Pixel data valid.
0x33	0x6C	10-bit input enabled (10 × 2 = 20-bit).

Table 93. 20-Bit 525p YCrCb In, RGB Out

Subaddress	Setting	Description
0x17	0x02	Software reset.
0x00	0x1C	All DACs enabled. PLL enabled (8×).
0x01	0x10	ED-SDR input mode.
0x02	0x10	RGB output enabled. RGB output sync enabled.
0x30	0x00	525p at 59.94 Hz. HSYNC/VSYNC synchronization. EIA-770.2 output levels.
0x31	0x01	Pixel data valid.
0x33	0x6C	10-bit input enabled (10 × 2 = 20-bit).

Table 94. 30-Bit 525p YCrCb In (EAV/SAV), YPrPb Out

Subaddress	Setting	Description
0x17	0x02	Software reset.
0x00	0x1C	All DACs enabled. PLL enabled (8×).
0x01	0x10	ED-SDR input mode.
0x30	0x04	525p at 59.94 Hz. EAV/SAV synchronization. EIA-770.2 output levels.
0x31	0x01	Pixel data valid.
0x33	0x2C	4:4:4 input data. 10-bit input enabled (10 × 3 = 30-bit).

Table 95. 30-Bit 525p YCrCb In, YPrPb Out

Subaddress	Setting	Description
0x17	0x02	Software reset.
0x00	0x1C	All DACs enabled. PLL enabled (8×).
0x01	0x10	ED-SDR input mode.
0x30	0x00	525p at 59.94 Hz. HSYNC/VSYNC synchronization. EIA-770.2 output levels.
0x31	0x01	Pixel data valid.
0x33	0x2C	4:4:4 input data. 10-bit input enabled (10 × 3 = 30-bit).

Table 96. 30-Bit 525p YCrCb In (EAV/SAV), RGB Out

Subaddress	Setting	Description
0x17	0x02	Software reset.
0x00	0x1C	All DACs enabled. PLL enabled (8x).
0x01	0x10	ED-SDR input mode.
0x02	0x10	RGB output enabled. RGB output sync enabled.
0x30	0x04	525p at 59.94 Hz. EAV/SAV synchronization. EIA-770.2 output levels.
0x31	0x01	Pixel data valid.
0x33	0x2C	4:4:4 input data. 10-bit input enabled (10 × 3 = 30-bit).

Table 97. 30-Bit 525p YCrCb In, RGB Out

Subaddress	Setting	Description
0x17	0x02	Software reset.
0x00	0x1C	All DACs enabled. PLL enabled (8x).
0x01	0x10	ED-SDR input mode.
0x02	0x10	RGB output enabled. RGB output sync enabled.
0x30	0x00	525p at 59.94 Hz. HSYNC/VSYNC synchronization. EIA-770.2 output levels.
0x31	0x01	Pixel data valid.
0x33	0x2C	4:4:4 input data. 10-bit input enabled (10 × 3 = 30-bit).

Table 98. 30-Bit 525p RGB In, RGB Out

Subaddress	Setting	Description
0x17	0x02	Software reset.
0x00	0x1C	All DACs enabled. PLL enabled (8x).
0x01	0x10	ED-SDR input mode.
0x02	0x10	RGB output enabled. RGB output sync enabled.
0x30	0x00	525p at 59.94 Hz. HSYNC/VSYNC synchronization. EIA-770.2 output levels.
0x31	0x01	Pixel data valid.
0x33	0x2C	4:4:4 input data. 10-bit input enabled (10 × 3 = 30-bit).
0x35	0x02	RGB input enabled.

Table 99. 10-Bit 625p YCrCb In (EAV/SAV), YPrPb Out

Subaddress	Setting	Description
0x17	0x02	Software reset.
0x00	0x1C	All DACs enabled. PLL enabled (8x).
0x01	0x20	ED-DDR input mode. Luma data clocked on falling edge of CLKIN.
0x30	0x1C	625p at 50 Hz. EAV/SAV synchronization. EIA-770.2 output levels.
0x31	0x01	Pixel data valid.
0x33	0x6C	10-bit input enabled.

Table 100. 10-Bit 625p YCrCb In, YPrPb Out

Subaddress	Setting	Description
0x17	0x02	Software reset.
0x00	0x1C	All DACs enabled. PLL enabled (8x).
0x01	0x20	ED-DDR input mode. Luma data clocked on falling edge of CLKIN.
0x30	0x18	625p at 50 Hz. HSYNC/VSYNC synchronization. EIA-770.2 output levels.
0x31	0x01	Pixel data valid.
0x33	0x6C	10-bit input enabled.

Table 101. 10-Bit 625p YCrCb In (EAV/SAV), RGB Out

Subaddress	Setting	Description
0x17	0x02	Software reset.
0x00	0x1C	All DACs enabled. PLL enabled (8x).
0x01	0x20	ED-DDR input mode. Luma data clocked on falling edge of CLKIN.
0x02	0x10	RGB output enabled. RGB output sync enabled.
0x30	0x1C	625p at 50 Hz. EAV/SAV synchronization. EIA-770.2 output levels.
0x31	0x01	Pixel data valid.
0x33	0x6C	10-bit input enabled.

Table 102. 10-Bit 625p YCrCb In, RGB Out

Subaddress	Setting	Description
0x17	0x02	Software reset.
0x00	0x1C	All DACs enabled. PLL enabled (8x).
0x01	0x20	ED-DDR input mode. Luma data clocked on falling edge of CLKIN.
0x02	0x10	RGB output enabled. RGB output sync enabled.
0x30	0x18	625p at 50 Hz. HSYNC/VSYNC synchronization. EIA-770.2 output levels.
0x31	0x01	Pixel data valid.
0x33	0x6C	10-bit input enabled.

Table 103. 20-Bit 625p YCrCb In (EAV/SAV), YPrPb Out

Subaddress	Setting	Description
0x17	0x02	Software reset.
0x00	0x1C	All DACs enabled. PLL enabled (8x).
0x01	0x10	ED-SDR input mode.
0x30	0x1C	625p at 50 Hz. EAV/SAV synchronization. EIA-770.2 output levels.
0x31	0x01	Pixel data valid.
0x33	0x6C	10-bit input enabled (10 × 2 = 20-bit).

Table 104. 20-Bit 625p YCrCb In, YPrPb Out

Subaddress	Setting	Description
0x17	0x02	Software reset.
0x00	0x1C	All DACs enabled. PLL enabled (8×).
0x01	0x10	ED-SDR input mode.
0x30	0x18	625p at 50 Hz. HSYNC/VSYNC synchronization. EIA-770.2 output levels.
0x31	0x01	Pixel data valid.
0x33	0x6C	10-bit input enabled (10 × 2 = 20-bit).

Table 105. 20-Bit 625p YCrCb In (EAV/SAV), RGB Out

Subaddress	Setting	Description
0x17	0x02	Software reset.
0x00	0x1C	All DACs enabled. PLL enabled (8×).
0x01	0x10	ED-SDR input mode.
0x02	0x10	RGB output enabled. RGB output sync enabled.
0x30	0x1C	625p at 50 Hz. EAV/SAV synchronization. EIA-770.2 output levels.
0x31	0x01	Pixel data valid.
0x33	0x6C	10-bit input enabled (10 × 2 = 20-bit).

Table 106. 20-Bit 625p YCrCb In, RGB Out

Subaddress	Setting	Description
0x17	0x02	Software reset.
0x00	0x1C	All DACs enabled. PLL enabled (8×).
0x01	0x10	ED-SDR input mode.
0x02	0x10	RGB output enabled. RGB output sync enabled.
0x30	0x18	625p at 50 Hz. HSYNC/VSYNC synchronization. EIA-770.2 output levels.
0x31	0x01	Pixel data valid.
0x33	0x6C	10-bit input enabled (10 × 2 = 20-bit).

Table 107. 30-Bit 625p YCrCb In (EAV/SAV), YPrPb Out

Subaddress	Setting	Description
0x17	0x02	Software reset.
0x00	0x1C	All DACs enabled. PLL enabled (8×).
0x01	0x10	ED-SDR input mode.
0x30	0x1C	625p at 50 Hz. EAV/SAV synchronization. EIA-770.2 output levels.
0x31	0x01	Pixel data valid.
0x33	0x2C	4:4:4 input data. 10-bit input enabled (10 × 3 = 30-bit).

Table 108. 30-Bit 625p YCrCb In, YPrPb Out

Subaddress	Setting	Description
0x17	0x02	Software reset.
0x00	0x1C	All DACs enabled. PLL enabled (8×).
0x01	0x10	ED-SDR input mode.
0x30	0x18	625p at 50 Hz. HSYNC/VSYNC synchronization. EIA-770.2 output levels.
0x31	0x01	Pixel data valid.
0x33	0x2C	4:4:4 input data. 10-bit input enabled (10 × 3 = 30-bit).

Table 109. 30-Bit 625p YCrCb In (EAV/SAV), RGB Out

Subaddress	Setting	Description
0x17	0x02	Software reset.
0x00	0x1C	All DACs enabled. PLL enabled (8×).
0x01	0x10	ED-SDR input mode.
0x02	0x10	RGB output enabled. RGB output sync enabled.
0x30	0x1C	625p at 50 Hz. EAV/SAV synchronization. EIA-770.2 output levels.
0x31	0x01	Pixel data valid.
0x33	0x2C	4:4:4 input data. 10-bit input enabled (10 × 3 = 30-bit).

Table 110. 30-Bit 625p YCrCb In, RGB Out

Subaddress	Setting	Description
0x17	0x02	Software reset.
0x00	0x1C	All DACs enabled. PLL enabled (8×).
0x01	0x10	ED-SDR input mode.
0x02	0x10	RGB output enabled. RGB output sync enabled.
0x30	0x18	625p at 50 Hz. HSYNC/VSYNC synchronization. EIA-770.2 output levels.
0x31	0x01	Pixel data valid.
0x33	0x2C	4:4:4 input data. 10-bit input enabled (10 × 3 = 30-bit).

Table 111. 30-Bit 625p RGB In, RGB Out

Subaddress	Setting	Description
0x17	0x02	Software reset.
0x00	0x1C	All DACs enabled. PLL enabled (8×).
0x01	0x10	ED-SDR input mode.
0x02	0x10	RGB output enabled. RGB output sync enabled.
0x30	0x18	625p at 50 Hz. HSYNC/VSYNC synchronization. EIA-770.2 output levels.
0x31	0x01	Pixel data valid.
0x33	0x2C	4:4:4 input data. 10-bit input enabled (10 × 3 = 30-bit).
0x35	0x02	RGB input enabled.

HIGH DEFINITION

Table 112. HD Configuration Scripts

Input Format	Input Data Width ¹	Synchronization Format	Input Color Space	Output Color Space	Table Number
720p at 60 Hz/59.94 Hz	10-bit DDR	EAV/SAV	YCrCb	YPrPb	Table 113
720p at 60 Hz/59.94 Hz	10-bit DDR	HSYNC/VSYNC	YCrCb	YPrPb	Table 114
720p at 60 Hz/59.94 Hz	10-bit DDR	EAV/SAV	YCrCb	RGB	Table 115
720p at 60 Hz/59.94 Hz	10-bit DDR	HSYNC/VSYNC	YCrCb	RGB	Table 116
720p at 60 Hz/59.94 Hz	20-bit SDR	EAV/SAV	YCrCb	YPrPb	Table 117
720p at 60 Hz/59.94 Hz	20-bit SDR	HSYNC/VSYNC	YCrCb	YPrPb	Table 118
720p at 60 Hz/59.94 Hz	20-bit SDR	EAV/SAV	YCrCb	RGB	Table 119
720p at 60 Hz/59.94 Hz	20-bit SDR	HSYNC/VSYNC	YCrCb	RGB	Table 120
720p at 60 Hz/59.94 Hz	30-bit SDR	EAV/SAV	YCrCb	YPrPb	Table 121
720p at 60 Hz/59.94 Hz	30-bit SDR	HSYNC/VSYNC	YCrCb	YPrPb	Table 122
720p at 60 Hz/59.94 Hz	30-bit SDR	EAV/SAV	YCrCb	RGB	Table 123
720p at 60 Hz/59.94 Hz	30-bit SDR	HSYNC/VSYNC	YCrCb	RGB	Table 124
720p at 60 Hz/59.94 Hz	30-bit SDR	HSYNC/VSYNC	RGB	RGB	Table 125
1080i at 30 Hz/29.97 Hz	10-bit DDR	EAV/SAV	YCrCb	YPrPb	Table 126
1080i at 30 Hz/29.97 Hz	10-bit DDR	HSYNC/VSYNC	YCrCb	YPrPb	Table 127
1080i at 30 Hz/29.97 Hz	10-bit DDR	EAV/SAV	YCrCb	RGB	Table 128
1080i at 30 Hz/29.97 Hz	10-bit DDR	HSYNC/VSYNC	YCrCb	RGB	Table 129
1080i at 30 Hz/29.97 Hz	20-bit SDR	EAV/SAV	YCrCb	YPrPb	Table 130
1080i at 30 Hz/29.97 Hz	20-bit SDR	HSYNC/VSYNC	YCrCb	YPrPb	Table 131
1080i at 30 Hz/29.97 Hz	20-bit SDR	EAV/SAV	YCrCb	RGB	Table 132
1080i at 30 Hz/29.97 Hz	20-bit SDR	HSYNC/VSYNC	YCrCb	RGB	Table 133
1080i at 30 Hz/29.97 Hz	30-bit SDR	EAV/SAV	YCrCb	YPrPb	Table 134
1080i at 30 Hz/29.97 Hz	30-bit SDR	HSYNC/VSYNC	YCrCb	YPrPb	Table 135
1080i at 30 Hz/29.97 Hz	30-bit SDR	EAV/SAV	YCrCb	RGB	Table 136
1080i at 30 Hz/29.97 Hz	30-bit SDR	HSYNC/VSYNC	YCrCb	RGB	Table 137
1080i at 30 Hz/29.97 Hz	30-bit SDR	HSYNC/VSYNC	RGB	RGB	Table 138

¹ SDR = single data rate. DDR = dual data rate.

Table 113. 10-Bit 720p YCrCb In (EAV/SAV), YPrPb Out

Subaddress	Setting	Description
0x17	0x02	Software reset.
0x00	0x1C	All DACs enabled. PLL enabled (4x).
0x01	0x20	HD-DDR input mode. Luma data clocked on falling edge of CLKIN.
0x30	0x2C	720p at 60 Hz/59.94 Hz. EAV/SAV synchronization. EIA-770.3 output levels.
0x31	0x01	Pixel data valid. 4x oversampling.
0x33	0x6C	10-bit input enabled.

Table 114. 10-Bit 720p YCrCb In, YPrPb Out

Subaddress	Setting	Description
0x17	0x02	Software reset.
0x00	0x1C	All DACs enabled. PLL enabled (4x).
0x01	0x20	HD-DDR input mode. Luma data clocked on falling edge of CLKIN.
0x30	0x28	720p at 60 Hz/59.94 Hz. HSYNC/VSYNC synchronization. EIA-770.3 output levels.
0x31	0x01	Pixel data valid. 4x oversampling.
0x33	0x6C	10-bit input enabled.

Table 115. 10-Bit 720p YCrCb In (EAV/SAV), RGB Out

Subaddress	Setting	Description
0x17	0x02	Software reset.
0x00	0x1C	All DACs enabled. PLL enabled (4x).
0x01	0x20	HD-DDR input mode. Luma data clocked on falling edge of CLKIN.
0x02	0x10	RGB output enabled. RGB output sync enabled.
0x30	0x2C	720p at 60 Hz/59.94 Hz. EAV/SAV synchronization. EIA-770.3 output levels.
0x31	0x01	Pixel data valid. 4x oversampling.
0x33	0x6C	10-bit input enabled.

Table 116. 10-Bit 720p YCrCb In, RGB Out

Subaddress	Setting	Description
0x17	0x02	Software reset.
0x00	0x1C	All DACs enabled. PLL enabled (4x).
0x01	0x20	HD-DDR input mode. Luma data clocked on falling edge of CLKIN.
0x02	0x10	RGB output enabled. RGB output sync enabled.
0x30	0x28	720p at 60 Hz/59.94 Hz. HSYNC/VSYNC synchronization. EIA-770.3 output levels.
0x31	0x01	Pixel data valid. 4x oversampling.
0x33	0x6C	10-bit input enabled.

Table 117. 20-Bit 720p YCrCb In (EAV/SAV), YPrPb Out

Subaddress	Setting	Description
0x17	0x02	Software reset.
0x00	0x1C	All DACs enabled. PLL enabled (4x).
0x01	0x10	HD-SDR input mode.
0x30	0x2C	720p at 60 Hz/59.94 Hz. EAV/SAV synchronization. EIA-770.3 output levels.
0x31	0x01	Pixel data valid. 4x oversampling.
0x33	0x6C	10-bit input enabled (10 × 2 = 20-bit).

Table 118. 20-Bit 720p YCrCb In, YPrPb Out

Subaddress	Setting	Description
0x17	0x02	Software reset.
0x00	0x1C	All DACs enabled. PLL enabled (4x).
0x01	0x10	HD-SDR input mode.
0x30	0x28	720p at 60 Hz/59.94 Hz. HSYNC/VSYNC synchronization. EIA-770.3 output levels.
0x31	0x01	Pixel data valid. 4x oversampling.
0x33	0x6C	10-bit input enabled (10 × 2 = 20-bit).

Table 119. 20-Bit 720p YCrCb In (EAV/SAV), RGB Out

Subaddress	Setting	Description
0x17	0x02	Software reset.
0x00	0x1C	All DACs enabled. PLL enabled (4x).
0x01	0x10	HD-SDR input mode.
0x02	0x10	RGB output enabled. RGB output sync enabled.
0x30	0x2C	720p at 60 Hz/59.94 Hz. EAV/SAV synchronization. EIA-770.3 output levels.
0x31	0x01	Pixel data valid. 4x oversampling.
0x33	0x6C	10-bit input enabled (10 × 2 = 20-bit).

Table 120. 20-Bit 720p YCrCb In, RGB Out

Subaddress	Setting	Description
0x17	0x02	Software reset.
0x00	0x1C	All DACs enabled. PLL enabled (4x).
0x01	0x10	HD-SDR input mode.
0x02	0x10	RGB output enabled. RGB output sync enabled.
0x30	0x28	720p at 60 Hz/59.94 Hz. HSYNC/VSYNC synchronization. EIA-770.3 output levels.
0x31	0x01	Pixel data valid. 4x oversampling.
0x33	0x6C	10-bit input enabled (10 × 2 = 20-bit).

Table 121. 30-Bit 720p YCrCb In (EAV/SAV), YPrPb Out

Subaddress	Setting	Description
0x17	0x02	Software reset.
0x00	0x1C	All DACs enabled. PLL enabled (4x).
0x01	0x10	HD-SDR input mode.
0x30	0x2C	720p at 60 Hz/59.94 Hz. EAV/SAV synchronization. EIA-770.3 output levels.
0x31	0x01	Pixel data valid. 4x oversampling.
0x33	0x2C	4:4:4 input data. 10-bit input enabled (10 × 3 = 30-bit).

Table 122. 30-Bit 720p YCrCb In, YPrPb Out

Subaddress	Setting	Description
0x17	0x02	Software reset.
0x00	0x1C	All DACs enabled. PLL enabled (4x).
0x01	0x10	HD-SDR input mode.
0x30	0x28	720p at 60 Hz/59.94 Hz. HSYNC/VSYNC synchronization. EIA-770.3 output levels.
0x31	0x01	Pixel data valid. 4x oversampling.
0x33	0x2C	4:4:4 input data. 10-bit input enabled (10 × 3 = 30-bit).

Table 123. 30-Bit 720p YCrCb In (EAV/SAV), RGB Out

Subaddress	Setting	Description
0x17	0x02	Software reset.
0x00	0x1C	All DACs enabled. PLL enabled (4x).
0x01	0x10	HD-SDR input mode.
0x02	0x10	RGB output enabled. RGB output sync enabled.
0x30	0x2C	720p at 60 Hz/59.94 Hz. EAV/SAV synchronization. EIA-770.3 output levels.
0x31	0x01	Pixel data valid. 4x oversampling.
0x33	0x2C	4:4:4 input data. 10-bit input enabled (10 × 3 = 30-bit).

Table 124. 30-Bit 720p YCrCb In, RGB Out

Subaddress	Setting	Description
0x17	0x02	Software reset.
0x00	0x1C	All DACs enabled. PLL enabled (4x).
0x01	0x10	HD-SDR input mode.
0x02	0x10	RGB output enabled. RGB output sync enabled.
0x30	0x28	720p at 60 Hz/59.94 Hz. HSYNC/VSYNC synchronization. EIA-770.3 output levels.
0x31	0x01	Pixel data valid. 4x oversampling.
0x33	0x2C	4:4:4 input data. 10-bit input enabled (10 × 3 = 30-bit).

Table 125. 30-Bit 720p RGB In, RGB Out

Subaddress	Setting	Description
0x17	0x02	Software reset.
0x00	0x1C	All DACs enabled. PLL enabled (4x).
0x01	0x10	HD-SDR input mode.
0x02	0x10	RGB output enabled. RGB output sync enabled.
0x30	0x28	720p at 60 Hz/59.94 Hz. HSYNC/VSYNC synchronization. EIA-770.3 output levels.
0x31	0x01	Pixel data valid. 4x oversampling.
0x33	0x2C	4:4:4 input data. 10-bit input enabled (10 × 3 = 30-bit).
0x35	0x02	RGB input enabled.

Table 126. 10-Bit 1080i YCrCb In (EAV/SAV), YPrPb Out

Subaddress	Setting	Description
0x17	0x02	Software reset.
0x00	0x1C	All DACs enabled. PLL enabled (4x).
0x01	0x20	HD-DDR input mode. Luma data clocked on falling edge of CLKIN.
0x30	0x6C	1080i at 30 Hz/29.97 Hz. EAV/SAV synchronization. EIA-770.3 output levels.
0x31	0x01	Pixel data valid. 4x oversampling.
0x33	0x6C	10-bit input enabled.

Table 127. 10-Bit 1080i YCrCb In, YPrPb Out

Subaddress	Setting	Description
0x17	0x02	Software reset.
0x00	0x1C	All DACs enabled. PLL enabled (4x).
0x01	0x20	HD-DDR input mode. Luma data clocked on falling edge of CLKIN.
0x30	0x68	1080i at 30 Hz/29.97 Hz. HSYNC/VSYNC synchronization. EIA-770.3 output levels.
0x31	0x01	Pixel data valid. 4x oversampling.
0x33	0x6C	10-bit input enabled.

Table 128. 10-Bit 1080i YCrCb In (EAV/SAV), RGB Out

Subaddress	Setting	Description
0x17	0x02	Software reset.
0x00	0x1C	All DACs enabled. PLL enabled (4x).
0x01	0x20	HD-DDR input mode. Luma data clocked on falling edge of CLKIN.
0x02	0x10	RGB output enabled. RGB output sync enabled.
0x30	0x6C	1080i at 30 Hz/29.97 Hz. HSYNC/VSYNC synchronization. EIA-770.3 output levels.
0x31	0x01	Pixel data valid. 4x oversampling.
0x33	0x6C	10-bit input enabled.

Table 129. 10-Bit 1080i YCrCb In, RGB Out

Subaddress	Setting	Description
0x17	0x02	Software reset.
0x00	0x1C	All DACs enabled. PLL enabled (4x).
0x01	0x20	HD-DDR input mode. Luma data clocked on falling edge of CLKIN.
0x02	0x10	RGB output enabled. RGB output sync enabled.
0x30	0x68	1080i at 30 Hz/29.97 Hz. EAV/SAV synchronization. EIA-770.3 output levels.
0x31	0x01	Pixel data valid. 4x oversampling.
0x33	0x6C	10-bit input enabled.

Table 130. 20-Bit 1080i YCrCb In (EAV/SAV), YPrPb Out

Subaddress	Setting	Description
0x17	0x02	Software reset.
0x00	0x1C	All DACs enabled. PLL enabled (4x).
0x01	0x10	HD-SDR input mode.
0x30	0x6C	1080i at 30 Hz/29.97 Hz. EAV/SAV synchronization. EIA-770.3 output levels.
0x31	0x01	Pixel data valid. 4x oversampling.
0x33	0x6C	10-bit input enabled (10 × 2 = 20-bit).

Table 131. 20-Bit 1080i YCrCb In, YPrPb Out

Subaddress	Setting	Description
0x17	0x02	Software reset.
0x00	0x1C	All DACs enabled. PLL enabled (4x).
0x01	0x10	HD-SDR input mode.
0x30	0x68	1080i at 30 Hz/29.97 Hz. HSYNC/VSYNC synchronization. EIA-770.3 output levels.
0x31	0x01	Pixel data valid. 4x oversampling.
0x33	0x6C	10-bit input enabled (10 × 2 = 20-bit).

Table 132. 20-Bit 1080i YCrCb In (EAV/SAV), RGB Out

Subaddress	Setting	Description
0x17	0x02	Software reset.
0x00	0x1C	All DACs enabled. PLL enabled (4x).
0x01	0x10	HD-SDR input mode.
0x02	0x10	RGB output enabled. RGB output sync enabled.
0x30	0x6C	1080i at 30 Hz/29.97 Hz. EAV/SAV synchronization. EIA-770.3 output levels.
0x31	0x01	Pixel data valid. 4x oversampling.
0x33	0x6C	10-bit input enabled (10 × 2 = 20-bit).

Table 133. 20-Bit 1080i YCrCb In, RGB Out

Subaddress	Setting	Description
0x17	0x02	Software reset.
0x00	0x1C	All DACs enabled. PLL enabled (4x).
0x01	0x10	HD-SDR input mode.
0x02	0x10	RGB output enabled. RGB output sync enabled.
0x30	0x68	1080i at 30 Hz/29.97 Hz. HSYNC/VSYNC synchronization. EIA-770.3 output levels.
0x31	0x01	Pixel data valid. 4x oversampling.
0x33	0x6C	10-bit input enabled (10 × 2 = 20-bit).

Table 134. 30-Bit 1080i YCrCb In (EAV/SAV), YPrPb Out

Subaddress	Setting	Description
0x17	0x02	Software reset.
0x00	0x1C	All DACs enabled. PLL enabled (4x).
0x01	0x10	HD-SDR input mode.
0x30	0x6C	1080i at 30 Hz/29.97 Hz. EAV/SAV synchronization. EIA-770.3 output levels.
0x31	0x01	Pixel data valid. 4x oversampling.
0x33	0x2C	4:4:4 input data. 10-bit input enabled (10 × 3 = 30-bit).

Table 135. 30-Bit 1080i YCrCb In, YPrPb Out

Subaddress	Setting	Description
0x17	0x02	Software reset.
0x00	0x1C	All DACs enabled. PLL enabled (4x).
0x01	0x10	HD-SDR input mode.
0x30	0x68	1080i at 30 Hz/29.97 Hz. HSYNC/VSYNC synchronization. EIA-770.3 output levels.
0x31	0x01	Pixel data valid. 4x oversampling.
0x33	0x2C	4:4:4 input data. 10-bit input enabled (10 × 3 = 30-bit).

Table 136. 30-Bit 1080i YCrCb In (EAV/SAV), RGB Out

Subaddress	Setting	Description
0x17	0x02	Software reset.
0x00	0x1C	All DACs enabled. PLL enabled (4x).
0x01	0x10	HD-SDR input mode.
0x02	0x10	RGB output enabled. RGB output sync enabled.
0x30	0x6C	1080i at 30 Hz/29.97 Hz. EAV/SAV synchronization. EIA-770.3 output levels.
0x31	0x01	Pixel data valid. 4x oversampling.
0x33	0x2C	4:4:4 input data. 10-bit input enabled (10 × 3 = 30-bit).

Table 137. 30-Bit 1080i YCrCb In, RGB Out

Subaddress	Setting	Description
0x17	0x02	Software reset.
0x00	0x1C	All DACs enabled. PLL enabled (4x).
0x01	0x10	HD-SDR input mode.
0x02	0x10	RGB output enabled. RGB output sync enabled.
0x30	0x68	1080i at 30 Hz/29.97 Hz. HSYNC/VSYNC synchronization. EIA-770.3 output levels.
0x31	0x01	Pixel data valid. 4x oversampling.
0x33	0x2C	4:4:4 input data. 10-bit input enabled (10 × 3 = 30-bit).

Table 138. 30-Bit 1080i RGB In, RGB Out

Subaddress	Setting	Description
0x17	0x02	Software reset.
0x00	0x1C	All DACs enabled. PLL enabled (4x).
0x01	0x10	HD-SDR input mode.
0x02	0x10	RGB output enabled. RGB output sync enabled.
0x30	0x68	1080i at 30 Hz/29.97 Hz. HSYNC/VSYNC synchronization. EIA-770.3 output levels.
0x31	0x01	Pixel data valid. 4x oversampling.
0x33	0x2C	4:4:4 input data. 10-bit input enabled (10 × 3 = 30-bit).
0x35	0x02	RGB input enabled.

OUTLINE DIMENSIONS

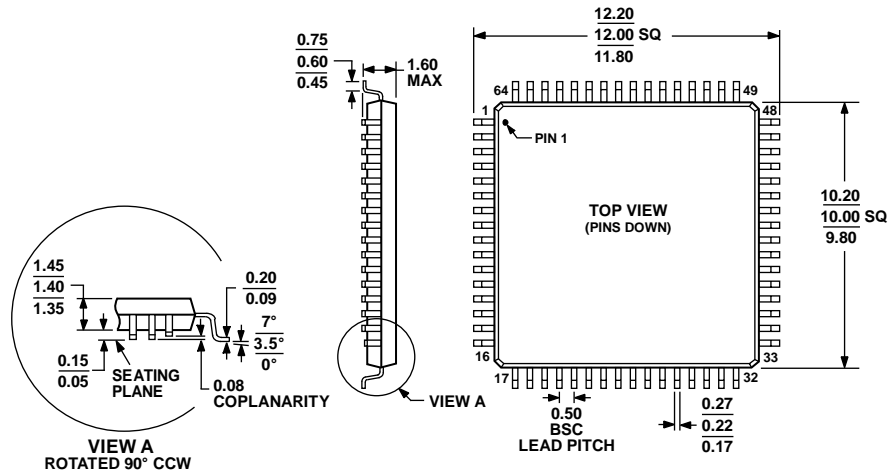

COMPLIANT TO JEDEC STANDARDS MS-026-BCD

Figure 139. 64-Lead Low Profile Quad Flat Package [LQFP] (ST-64-2)

Dimensions shown in millimeters

051706-A

ORDERING GUIDE

Model ¹	Temperature Range	Macrovision ² Antitaping	Package Description	Package Option
ADV7340BSTZ	-40°C to +85°C	Yes	64-Lead Low Profile Quad Flat Package [LQFP]	ST-64-2
ADV7341BSTZ	-40°C to +85°C	No	64-Lead Low Profile Quad Flat Package [LQFP]	ST-64-2
EVAL-ADV7340EBZ		Yes	ADV7340 Evaluation Platform	
EVAL-ADV7341EBZ		No	ADV7341 Evaluation Platform	

¹ Z = RoHS Compliant Part.

² Macrovision-enabled ICs require the buyer to be an approved licensee (authorized buyer) of ICs that are able to output Macrovision Rev 7.1.L1-compliant video.

I²C refers to a communications protocol originally developed by Philips Semiconductors (now NXP Semiconductors).

Looking for pricing, stock, or lifecycle information?

Click below to explore more details on WIN SOURCE:

 [View ADV7340BSTZ on WIN SOURCE](#)

 [Analog Devices Inc. Information](#)

Optimize Your Supply Chain with WIN SOURCE Solutions

-  Global Sourcing Solution
-  Obsolete Management
-  Cost Control Management
-  Shortage Management
-  Alternative Solution
-  Excess Inventory Management