



**THE DATASHEET OF  
PE-53831SNL**



# SMT Power Inductor

Toroid - Designed for National's 150kHz Simple Switcher™



- Ⓟ Tested and recommended by National Semiconductor
- Ⓟ Base material meets flammability requirements of UL 94V-0
- Ⓟ Available in surface mount and through hole versions

Electrical Specifications @ 25°C - Operating Temperature -40°C to +125°C

Pulse THT Part Number	Pulse SMT Part Number	National Part Number	Turns Ratio			Nominal DCR (Ω)	Package		
			Nominal Inductance (μH)	Rated Current (A <sub>DC</sub> )	Max ETOP (V-μSec)		Through Hole	Surface Mount	Lead Diameter
PE-53801NL *	PE-53801SNL	LM259X-L1	259	0.13	23.1	3.4	LP-25	LCI-20	-
PE-53802NL	PE-53802SNL	LM259X-L2	178	0.16	16.5	2.8	LP-25	LCI-20	-
PE-53803NL	PE-53803SNL	LM259X-L3	118	0.2	13.2	1.8	LP-25	LCI-20	-
PE-53804NL *	PE-53804SNL *	LM259X-L4	79	0.25	9.9	1.5	LP-25	LCI-20	-
PE-53805NL *	PE-53805SNL *	LM259X-L5	55	0.3	6.6	1.0	LP-25	LCI-20	-
PE-53806NL *	PE-53806SNL	LM259X-L6	39	0.34	6.6	.80	LP-25	LCI-20	-
PE-53807NL	PE-53807SNL *	LM259X-L7	26	0.45	6.6	.62	LP-25	LCI-20	-
PE-53808NL	PE-53808SNL	LM259X-L8	374	0.2	75.9	2.7	LP-30	LCI-30	-
PE-53809NL	PE-53809SNL	LM259X-L9	256	0.25	33	2.2	LP-30	LCI-30	-
PE-53810NL	PE-53810SNL	LM259X-L10	176	0.3	26.4	1.4	LP-30	LCI-30	-
PE-53811NL	PE-53811SNL	LM259X-L11	118	0.38	19.8	1.2	LP-30	LCI-30	-
PE-53812NL	PE-53812SNL	LM259X-L12	78	0.46	16.5	0.8	LP-30	LCI-30	-
PE-53813NL *	PE-53813SNL	LM259X-L13	55	0.56	13.2	0.5	LP-30	LCI-30	-
PE-53814NL	PE-53814SNL	LM259X-L14	39	0.68	9.9	0.3	LP-30	LCI-30	-
PE-53815NL *	PE-53815SNL	LM259X-L15	26	0.84	6.6	0.2	LP-30	LCI-30	-
PE-53816NL	PE-53816SNL	LM259X-L16	17	1.02	6.6	0.1	LP-30	LCI-30	-
PE-53817NL	PE-53817SNL	LM259X-L17	375	0.36	75.9	1.3	LP-37	LCI-37	-
PE-53818NL	PE-53818SNL	LM259X-L18	252	0.44	49.5	0.9	LP-37	LCI-37	-
PE-53819NL	PE-53819SNL	LM259X-L19	173	0.54	36.3	0.6	LP-37	LCI-37	-
PE-53820NL	PE-53820SNL	LM259X-L20	115	0.67	29.7	0.4	LP-37	LCI-37	-
PE-53821NL	PE-53821SNL	LM259X-L21	78	0.82	23.1	0.3	LP-37	LCI-37	-
PE-53822NL	PE-53822SNL	LM259X-L22	54	1.0	16.5	0.2	LP-37	LCI-37	-
PE-53823NL	PE-53823SNL	LM259X-L23	38	1.2	13.2	0.1	LP-37	LCI-37	-
PE-53824NL *	PE-53824SNL	LM259X-L24	26	1.48	9.9	0.1	LP-37	LCI-37	-
PE-53825NL	PE-53825SNL	LM259X-L25	18	1.81	9.9	0.06	LP-37	LCI-37	-

# SMT Power Inductor

Toroid - Designed for National's 150kHz Simple Switcher™



## Electrical Specifications @ 25°C - Operating Temperature -40°C to +125°C

Pulse THT Part Number	Pulse SMT Part Number	National Part Number	Turns Ratio			Nominal DCR (Ω)	Package		
			Nominal Inductance (μH)	Rated Current (A <sub>DC</sub> )	Max ETOP (V-μSec)		Through Hole	Surface Mount	Lead Diameter
PE-53827NL	PE-53827SNL	LM259X-L27	248	0.83	72.6	0.6	LP-44	LCI-44	-
PE-53828NL	PE-53828SNL	LM259X-L28	168	1.02	56.1	0.4	LP-44	LCI-44	-
PE-53829NL	PE-53829SNL	LM259X-L29	112	1.26	42.9	0.3	LP-44	LCI-44	-
PE-53830NL	PE-53830SNL	LM259X-L30	77	1.54	33	0.2	LP-44	LCI-44	-
PE-53831NL	PE-53831SNL	LM259X-L31	53	1.87	26.4	0.13	LP-44	LCI-44	-
PE-53932NL	PE-53932SNL	LM259X-L32	37	2.24	19.8	0.10	LP-44	LCI-44	-
PE-53933NL	PE-53933SNL	LM259X-L33	24	2.74	16.5	0.07	LP-44	LCI-44	-
PE-53934NL *	PE-53934SNL	LM259X-L34	17	3.0	13.2	0.05	KM-1.0	LCI-44	.023
PE-53935NL	PE-53935SNL	LM259X-L35	250	1.5	72.6	0.23	KM-3.0	HCI-68	.023
PE-54036NL	PE-54036SNL	LM259X-L36	168	1.81	75.9	0.18	KM-3.0	HCI-68	.023
PE-54037NL	PE-54037SNL	LM259X-L37	114	2.22	62.7	0.10	KM-3.0	HCI-68	.025
PE-54038NL	PE-54038SNL	LM259X-L38	77	2.7	52.8	0.09	KM-3.0	HCI-68	.025
PE-54039NL	PE-54039SNL	LM259X-L39	53	3.0	42.9	0.08	KM-3.0	HCI-68	.025
PE-54040NL	PE-54040SNL	LM259X-L40	38	3.0	29.7	0.05	KM-3.0	HCI-68	.028
PE-54041NL	PE-54041SNL	LM259X-L41	25	3.0	19.8	0.04	KM-2.0	LCI-50	.028
PE-54042NL	-	LM259X-L42	167	2.5	75.9	0.14	KM-4.0	-	.028
PE-54043NL	-	LM259X-L43	121	3.0	75.9	0.09	KM-4.0	-	.031
PE-54044NL	PE-54044SNL	LM259X-L44	77	3.0	59.4	0.08	KM-3.0	HCI-68	.025
PE-53900NL	-	LM259X-L	19	4.5	32 <sup>3</sup>	0.02	KM-3.0	-	.035

### Notes:

- Inductance values may vary ±20%.
- ETop rated at 150kHz except where designated.
- ETop rated at 100kHz.
- SIMPLE SWITCHER™ is a trademark of National Semiconductor Corp.
- For SMT parts, optional Tape & Reel packaging can be ordered by adding a "T" suffix to the part number (i.e. PE-53801SNL becomes PE-53801SNLT). Pulse complies to industry standard tape and reel specification EIA481.
- The "NL" suffix indicates an RoHS-compliant part number. Non-NL suffixed parts are not necessarily RoHS-compliant, but are electrically and mechanically equivalent to NL versions. If a part number does not have the "NL" suffix, but an RoHS compliant version is required, please contact Pulse for availability.
- The temperature of the component (ambient plus temperature rise) must be within the stated operating temperature range.  
\* Contact Pulse for availability

# SMT Power Inductor

Toroid - Designed for National's 150kHz Simple Switcher™

## Mechanical

### LP series



PKG	A	B	C	D
LP-25	$\frac{.360}{9,14}$	$\frac{.310}{7,87}$	$\frac{.250}{6,35}$	$\frac{.250}{6,35}$
LP-30	$\frac{.400}{10,16}$	$\frac{.300}{7,62}$	$\frac{.300}{7,62}$	$\frac{.300}{7,62}$
LP-37	$\frac{.495}{12,57}$	$\frac{.375}{9,52}$	$\frac{.375}{9,52}$	$\frac{.375}{9,52}$
LP-44	$\frac{.635}{16,13}$	$\frac{.365}{9,27}$	$\frac{.500}{12,7}$	$\frac{.300}{7,62}$

## Mechanical

### KM Series

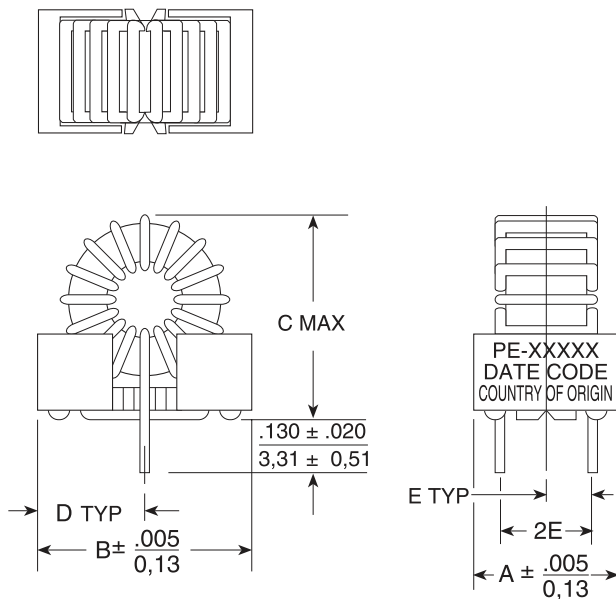

PKG	A	B	C	D	E
KM-1.0	$\frac{.340}{8,64}$	$\frac{.580}{14,73}$	$\frac{.650}{16,51}$	$\frac{.290}{7,37}$	$\frac{.110}{2,79}$
KM-2.0	$\frac{.450}{11,43}$	$\frac{.650}{16,51}$	$\frac{.700}{17,73}$	$\frac{.325}{8,26}$	$\frac{.150}{3,81}$
KM-3.0	$\frac{.450}{11,43}$	$\frac{.830}{21,08}$	$\frac{.950}{24,13}$	$\frac{.415}{10,54}$	$\frac{.150}{3,81}$
KM-4.0	$\frac{.610}{15,50}$	$\frac{.970}{24,64}$	$\frac{1.10}{27,94}$	$\frac{.475}{12,07}$	$\frac{.225}{5,72}$

# SMT Power Inductor

Toroid - Designed for National's 150kHz Simple Switcher™

## Mechanical

### LCI Series



PKG	A	B	C	D	E	F
LCI-20	.340 8,64	.340 8,64	.270 6,86	.260 6,60	.300 7,62	.270 6,86
LCI-30	.450 11,05	.440 11,18	.360 9,14	.350 8,89	.400 10,16	.360 9,14
LCI-37	.565 14,35	.570 14,48	.360 9,14	.450 11,43	.520 13,21	.460 11,68
LCI-44	.600 15,24	.620 15,75	.390 9,91	.500 12,7	.550 13,97	.510 12,95
LCI-50	.670 17,02	.700 17,78	.390 9,91	.580 14,73	.620 15,75	.590 14,99

**Notes:**

Dimension "D" is measured across terminal blocks only.

Coil must clear seating plane by  $\frac{.010}{0,25}$  MIN

## Mechanical

### HCI-68

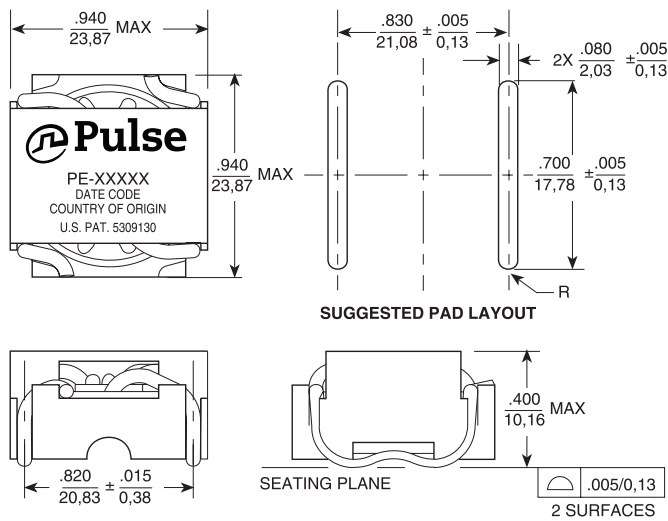

**Notes:**

Coil must clear seating plane by  $\frac{.010}{0,25}$  MIN

**Dimensions:**  $\frac{\text{Inches}}{\text{mm}}$   
Unless otherwise specified,  
all tolerances are:  $\pm \frac{.010}{0,25}$

## Looking for pricing, stock, or lifecycle information?

Click below to explore more details on WIN SOURCE:

 [View PE-53831SNL on WIN SOURCE](#)

 [Pulse Information](#)

## Optimize Your Supply Chain with WIN SOURCE Solutions

-  Global Sourcing Solution
-  Obsolete Management
-  Cost Control Management
-  Shortage Management
-  Alternative Solution
-  Excess Inventory Management