



**THE DATASHEET OF  
TPS76425DBVRG4**



# TPS76425, TPS76427, TPS76428, TPS76430, TPS76433 LOW-POWER LOW-NOISE 150-mA LOW-DROPOUT LINEAR REGULATORS

SLVS180B – MARCH 1999 – REVISED MAY 2001

- 150-mA Low Noise, Low-Dropout Regulator
- Output Voltage: 2.5 V, 2.7 V, 2.8 V, 3.0 V, 3.3 V
- Output Noise Typically 50  $\mu$ V
- Quiescent Current Typically 85  $\mu$ A
- Dropout Voltage, Typically 300 mV at 150 mA
- Thermal Protection
- Over Current Limitation
- Less Than 2- $\mu$ A Quiescent Current in Shutdown Mode
- -40°C to 125°C Operating Junction Temperature Range
- 5-Pin SOT-23 (DBV) Package

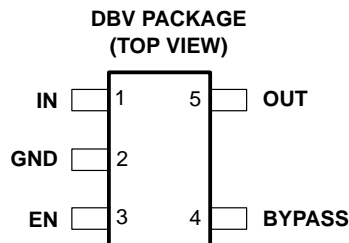

## description

The TPS764xx family of low-dropout (LDO) voltage regulators offers the benefits of a low noise, low-dropout voltage, low-power operation, and miniaturized package. Additionally, they feature low quiescent current when compared to conventional LDO regulators. Offered in 5-terminal small outline integrated-circuit SOT-23 package, the TPS764xx series devices are ideal for low-noise applications, cost-sensitive designs and applications where board space is at a premium.

A combination of new circuit design and process innovation has enabled the usual pnp pass transistor to be replaced by a PMOS pass element. Because the PMOS pass element behaves as a low-value resistor, the dropout voltage is very low—typically 300 mV at 150 mA of load current (TPS76433)—and is directly proportional to the load current. Since the PMOS pass element is a voltage-driven device, the quiescent current is very low (140  $\mu$ A maximum) and is stable over the entire range of output load current (0 mA to 150 mA). Intended for use in portable systems such as laptops and cellular phones, the low-dropout voltage feature and low-power operation result in a significant increase in system battery operating life.

The TPS764xx also features a logic-enabled sleep mode to shut down the regulator, reducing quiescent current to 1  $\mu$ A maximum at  $T_J = 25^\circ\text{C}$ . The TPS764xx is offered in 2.5-V, 2.7-V, 2.8-V, 3.0-V, and 3.3-V fixed-voltages.

## AVAILABLE OPTIONS

| $T_J$          | VOLTAGE | PACKAGE         | PART NUMBER   |               | SYMBOL |
|----------------|---------|-----------------|---------------|---------------|--------|
| -40°C to 125°C | 2.5 V   | SOT-23<br>(DBV) | TPS76425DBVT† | TPS76425DBVR‡ | PBJI   |
|                | 2.7 V   |                 | TPS76427DBVT† | TPS76427DBVR‡ | PBKI   |
|                | 2.8 V   |                 | TPS76428DBVT† | TPS76428DBVR‡ | PCEI   |
|                | 3.0 V   |                 | TPS76430DBVT† | TPS76430DBVR‡ | PBLI   |
|                | 3.3 V   |                 | TPS76433DBVT† | TPS76433DBVR‡ | PBMI   |

† The DBVT passive indicates tape and reel of 250 parts.

‡ The DBVR passive indicates tape and reel of 3000 parts.



Please be aware that an important notice concerning availability, standard warranty, and use in critical applications of Texas Instruments semiconductor products and disclaimers thereto appears at the end of this data sheet.

PRODUCTION DATA information is current as of publication date. Products conform to specifications per the terms of Texas Instruments standard warranty. Production processing does not necessarily include testing of all parameters.

 **TEXAS  
INSTRUMENTS**

POST OFFICE BOX 655303 • DALLAS, TEXAS 75265

Copyright © 2001, Texas Instruments Incorporated

# TPS76425, TPS76427, TPS76428, TPS76430, TPS76433

## LOW-POWER LOW-NOISE 150-mA LOW-DROPOUT LINEAR REGULATORS

SLVS180B – MARCH 1999 – REVISED MAY 2001

### functional block diagram

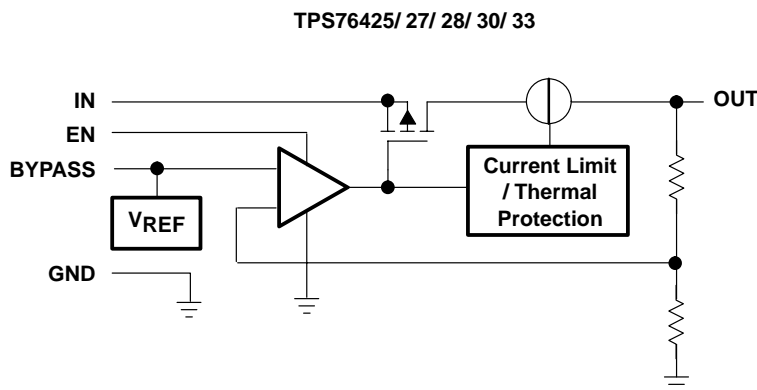

### Terminal Functions

| TERMINAL NAME | I/O | DESCRIPTION              |
|---------------|-----|--------------------------|
| GND           |     | Ground                   |
| EN            | I   | Enable input             |
| BYPASS        |     | Output bypass capacitor  |
| IN            | I   | Input supply voltage     |
| OUT           | O   | Regulated output voltage |

### absolute maximum ratings over operating free-air temperature range (unless otherwise noted)<sup>†</sup>

|   |                               |
|---|-------------------------------|
| Input voltage range (see Note 1)                    | –0.3 V to 10 V                |
| Voltage range at EN                                 | –0.3 V to $V_I + 0.3$ V       |
| Voltage on OUT,                                     | 7 V                           |
| Peak output current                                 | Internally limited            |
| ESD rating, HBM                                     | 2 kV                          |
| Continuous total power dissipation                  | See dissipation rating tables |
| Operating virtual junction temperature range, $T_J$ | –40°C to 150°C                |
| Storage temperature range, $T_{stg}$                | –65°C to 150°C                |

<sup>†</sup> Stresses beyond those listed under “absolute maximum ratings” may cause permanent damage to the device. These are stress ratings only, and functional operation of the device at these or any other conditions beyond those indicated under “recommended operating conditions” is not implied. Exposure to absolute-maximum-rated conditions for extended periods may affect device reliability.

NOTE 1: All voltage values are with respect to network ground terminal.

DISSIPATION RATING TABLE

| BOARD               | PACKAGE | $R_{\theta JC}$ | $R_{\theta JA}$ | DERATING FACTOR<br>ABOVE $T_A = 25^\circ\text{C}$ | $T_A \leq 25^\circ\text{C}$<br>POWER RATING | $T_A = 70^\circ\text{C}$<br>POWER RATING | $T_A = 85^\circ\text{C}$<br>POWER RATING |
|---------------------|---------|-----------------|-----------------|---|---|--|--|
| Low K <sup>‡</sup>  | DBV     | 65.8 °C/W       | 259 °C/W        | 3.9 mW/°C   | 386 mW                                      | 212 mW                                   | 154 mW                                   |
| High K <sup>§</sup> | DBV     | 65.8 °C/W       | 180 °C/W        | 5.6 mW/°C   | 555 mW                                      | 305 mW                                   | 222 mW                                   |

<sup>‡</sup> The JEDEC Low K (1s) board design used to derive this data was a 3 inch x 3 inch, two layer board with 2 ounce copper traces on top of the board.

<sup>§</sup> The JEDEC High K (2s2p) board design used to derive this data was a 3 inch x 3 inch, multilayer board with 1 ounce internal power and ground planes and 2 ounce copper traces on top and bottom of the board.



POST OFFICE BOX 655303 • DALLAS, TEXAS 75265

# TPS76425, TPS76427, TPS76428, TPS76430, TPS76433 LOW-POWER LOW-NOISE 150-mA LOW-DROPOUT LINEAR REGULATORS

SLVS180B – MARCH 1999 – REVISED MAY 2001

## recommended operating conditions

|                                       | MIN | NOM | MAX | UNIT |
|---------------------------------------|-----|-----|-----|------|
| Input voltage, $V_I$ †                | 2.7 |     | 10  | V    |
| Continuous output current, $I_O$      | 0   |     | 150 | mA   |
| Operating junction temperature, $T_J$ | -40 |     | 125 | °C   |

† To calculate the minimum input voltage for your maximum output current, use the following equation:  $V_{I(\min)} = V_{O(\max)} + V_{DO(\max \text{ load})}$

## electrical characteristics over recommended operating free-air temperature range, $V_I = V_{O(\text{typ})} + 1 \text{ V}$ , $I_O = 1 \text{ mA}$ , $EN = IN$ , $C_O = 4.7 \mu\text{F}$ (unless otherwise noted)

| PARAMETER |   | TEST CONDITIONS   | MIN  | TYP   | MAX | UNIT          |   |
|-----------|---|---|--|-------|-----|---------------|---|
| $V_O$     | Output voltage                              | TPS76425  | $I_O = 1 \text{ mA to } 100 \text{ mA}$ , $T_J = 25^\circ\text{C}$ | 2.45  | 2.5 | 2.55          | V |
|           |   |   | $I_O = 1 \text{ mA to } 100 \text{ mA}$                            | 2.425 | 2.5 | 2.575         |   |
|           |   |   | $I_O = 1 \text{ mA to } 150 \text{ mA}$ , $T_J = 25^\circ\text{C}$ | 2.438 | 2.5 | 2.562         |   |
|           |   |   | $I_O = 1 \text{ mA to } 150 \text{ mA}$                            | 2.407 | 2.5 | 2.593         |   |
|           |   | TPS76427  | $I_O = 1 \text{ mA to } 100 \text{ mA}$ , $T_J = 25^\circ\text{C}$ | 2.646 | 2.7 | 2.754         | V |
|           |   |   | $I_O = 1 \text{ mA to } 100 \text{ mA}$                            | 2.619 | 2.7 | 2.781         |   |
|           |   |   | $I_O = 1 \text{ mA to } 150 \text{ mA}$ , $T_J = 25^\circ\text{C}$ | 2.632 | 2.7 | 2.768         |   |
|           |   |   | $I_O = 1 \text{ mA to } 150 \text{ mA}$                            | 2.598 | 2.7 | 2.8013        |   |
|           |   | TPS76428  | $I_O = 1 \text{ mA to } 100 \text{ mA}$ , $T_J = 25^\circ\text{C}$ | 2.744 | 2.8 | 2.856         | V |
|           |   |   | $I_O = 1 \text{ mA to } 150 \text{ mA}$ ,                          | 2.73  | 2.8 | 2.870         |   |
|           |   |   | $I_O = 1 \text{ mA to } 150 \text{ mA}$ , $T_J = 25^\circ\text{C}$ | 2.716 | 2.8 | 2.884         |   |
|           |   |   | $I_O = 1 \text{ mA to } 150 \text{ mA}$                            | 2.695 | 2.8 | 2.905         |   |
|           |   | TPS76430  | $I_O = 1 \text{ mA to } 100 \text{ mA}$ , $T_J = 25^\circ\text{C}$ | 2.94  | 3.0 | 3.06          | V |
|           |   |   | $I_O = 1 \text{ mA to } 100 \text{ mA}$                            | 2.925 | 3.0 | 3.075         |   |
|           |   |   | $I_O = 1 \text{ mA to } 150 \text{ mA}$ , $T_J = 25^\circ\text{C}$ | 2.91  | 3.0 | 3.090         |   |
|           |   |   | $I_O = 1 \text{ mA to } 150 \text{ mA}$                            | 2.887 | 3.0 | 3.112         |   |
|           |   | TPS76433  | $I_O = 1 \text{ mA to } 100 \text{ mA}$ , $T_J = 25^\circ\text{C}$ | 3.234 | 3.3 | 3.366         | V |
|           |   |   | $I_O = 1 \text{ mA to } 100 \text{ mA}$                            | 3.201 | 3.3 | 3.399         |   |
|           |   |   | $I_O = 1 \text{ mA to } 150 \text{ mA}$ , $T_J = 25^\circ\text{C}$ | 3.218 | 3.3 | 3.382         |   |
|           |   |   | $I_O = 1 \text{ mA to } 150 \text{ mA}$                            | 3.177 | 3.3 | 3.423         |   |
| $I_{(Q)}$ | Quiescent current<br>(GND terminal current) | $I_O = 0 \text{ to } 150 \text{ mA}$ , $T_J = 25^\circ\text{C}$ ,<br>See Note 2                                 |  | 85    | 100 | $\mu\text{A}$ |   |
|           |   | $I_O = 0 \text{ to } 150 \text{ mA}$ ,<br>See Note 2  |  |       | 140 |               |   |
|           | Standby current                             | $EN < 0.5 \text{ V}$ , $T_J = 25^\circ\text{C}$   |  | 0.5   | 1   |               |   |
|           |   | $EN < 0.5 \text{ V}$  |  |       | 2   |               |   |
| $V_n$     | Output noise voltage                        | $BW = 300 \text{ Hz to } 50 \text{ kHz}$ , $C_O = 10 \mu\text{F}$ ,<br>$T_J = 25^\circ\text{C}$ ,<br>See Note 2 |  | 50    |     | $\mu\text{V}$ |   |
|           | Bypass voltage                              | $T_J = 25^\circ\text{C}$  |  | 1.192 |     | V             |   |
| PSRR      | Ripple rejection                            | $f = 1 \text{ kHz}$ , $C_O = 10 \mu\text{F}$ , $T_J = 25^\circ\text{C}$ ,<br>See Note 2                         |  | 60    |     | dB            |   |
|           | Current limit                               | $T_J = 25^\circ\text{C}$  |  | 0.8   | 1.5 | A             |   |

NOTES: 2. Minimum  $I_N$  operating voltage is 2.7 V or  $V_{O(\text{typ})} + 1 \text{ V}$ , whichever is greater.  
3. Test condition includes, output voltage  $V_O = 0 \text{ V}$  and pulse duration = 10 mS.



# TPS76425, TPS76427, TPS76428, TPS76430, TPS76433

## LOW-POWER LOW-NOISE 150-mA LOW-DROPOUT LINEAR REGULATORS

SLVS180B – MARCH 1999 – REVISED MAY 2001

electrical characteristics over recommended operating free-air temperature range,  
 $V_I = V_{O(\text{typ})} + 1 \text{ V}$ ,  $I_O = 1 \text{ mA}$ ,  $EN = IN$ ,  $C_O = 4.7 \mu\text{F}$  (unless otherwise noted) (continued)

| PARAMETER   |                              | TEST CONDITIONS   | MIN   | TYP   | MAX  | UNIT          |     |
|---|------------------------------|---|---|-------|------|---------------|-----|
| Output voltage line regulation ( $\Delta V_O/V_O$ )<br>(see Note 4) |                              | $V_O + 1 \text{ V} < V_I \leq 10 \text{ V}$ , $V_I \geq 3.5 \text{ V}$ , $T_J = 25^\circ\text{C}$ |   | 0.04  | 0.07 | %V            |     |
|   |                              | $V_O + 1 \text{ V} < V_I \leq 10 \text{ V}$ , $V_I \geq 3.5 \text{ V}$                            |   |       | 0.1  |               |     |
| $V_{IH}$  | EN high level input          | See Note 2  |   | 1.4   | 2    | V             |     |
| $V_{IL}$  | EN low level input           | See Note 2  | 0.5   | 1.2   |      |               |     |
| $I_I$   | EN input current             | EN = 0 V  |   | -0.01 | -0.5 | $\mu\text{A}$ |     |
|   |                              | EN = IN   |   | -0.01 | -0.5 |               |     |
| $V_{DO}$  | Dropout voltage (see Note 5) | TPS76425  | $I_O = 0 \text{ mA}$ , $T_J = 25^\circ\text{C}$   |       | 0.2  | mV            |     |
|   |                              |   | $I_O = 1 \text{ mA}$ , $T_J = 25^\circ\text{C}$   |       | 3    |               |     |
|   |                              |   | $I_O = 50 \text{ mA}$ , $T_J = 25^\circ\text{C}$  |       | 120  |               | 150 |
|   |                              |   | $I_O = 50 \text{ mA}$                             |       |      |               | 200 |
|   |                              |   | $I_O = 75 \text{ mA}$ , $T_J = 25^\circ\text{C}$  |       | 180  |               | 225 |
|   |                              |   | $I_O = 75 \text{ mA}$                             |       |      |               | 300 |
|   |                              |   | $I_O = 100 \text{ mA}$ , $T_J = 25^\circ\text{C}$ |       | 240  |               | 300 |
|   |                              |   | $I_O = 100 \text{ mA}$                            |       |      |               | 400 |
|   |                              |   | $I_O = 150 \text{ mA}$ , $T_J = 25^\circ\text{C}$ |       | 360  |               | 450 |
|   |                              |   | $I_O = 150 \text{ mA}$                            |       |      |               | 600 |
|   |                              | TPS76433  | $I_O = 0 \text{ mA}$ , $T_J = 25^\circ\text{C}$   |       | 0.2  |               | mV  |
|   |                              |   | $I_O = 1 \text{ mA}$ , $T_J = 25^\circ\text{C}$   |       | 3    |               |     |
|   |                              |   | $I_O = 50 \text{ mA}$ , $T_J = 25^\circ\text{C}$  |       | 100  | 125           |     |
|   |                              |   | $I_O = 50 \text{ mA}$                             |       |      | 166           |     |
|   |                              |   | $I_O = 75 \text{ mA}$ , $T_J = 25^\circ\text{C}$  |       | 150  | 188           |     |
|   |                              |   | $I_O = 75 \text{ mA}$                             |       |      | 250           |     |
|   |                              |   | $I_O = 100 \text{ mA}$ , $T_J = 25^\circ\text{C}$ |       | 200  | 250           |     |
|   |                              |   | $I_O = 100 \text{ mA}$                            |       |      | 333           |     |
|   |                              |   | $I_O = 150 \text{ mA}$ , $T_J = 25^\circ\text{C}$ |       | 300  | 375           |     |
|   |                              |   | $I_O = 150 \text{ mA}$                            |       |      | 500           |     |

NOTES: 2. Minimum IN operating voltage is 2.7 V or  $V_{O(\text{typ})} + 1 \text{ V}$ , whichever is greater.

4. If  $V_O < 2.5 \text{ V}$  and  $V_{I\text{max}} = 10 \text{ V}$ ,  $V_{I\text{min}} = 3.5 \text{ V}$ :

$$\text{Line Reg. (mV)} = (\%/\text{V}) \times \frac{V_O(V_{I\text{max}} - 3.5 \text{ V})}{100} \times 1000$$

If  $V_O > 2.5 \text{ V}$  and  $V_{I\text{max}} = 10 \text{ V}$ ,  $V_{I\text{min}} = V_O + 1 \text{ V}$ :

$$\text{Line Reg. (mV)} = (\%/\text{V}) \times \frac{V_O(V_{I\text{max}} - (V_O + 1))}{100} \times 1000$$

5. Dropout voltage is defined as the differential voltage between  $V_O$  and  $V_I$  when  $V_O$  drops 100 mV below the value measured with  $V_I = V_O + 1.0 \text{ V}$ .



POST OFFICE BOX 655303 • DALLAS, TEXAS 75265

# TPS76425, TPS76427, TPS76428, TPS76430, TPS76433 LOW-POWER LOW-NOISE 150-mA LOW-DROPOUT LINEAR REGULATORS

SLVS180B – MARCH 1999 – REVISED MAY 2001

## TYPICAL CHARACTERISTICS

### Table of Graphs

|          |                                      | FIGURE                       |              |
|----------|--------------------------------------|------------------------------|--------------|
| $V_O$    | Output voltage                       | vs Output current            | 1            |
|          |                                      | vs Free-air temperature      | 2, 3, 4      |
| $V_n$    | Output noise                         | vs Frequency                 | 5            |
| $V_n$    | Output noise voltage                 | vs Bypass capacitance        | 6            |
|          |                                      | vs Load current              | 7            |
| $Z_O$    | Output impedance                     | vs Frequency                 | 8            |
| $V_{DO}$ | Dropout voltage                      | vs Free-air temperature      | 9            |
|          |                                      | Ripple rejection             | vs Frequency |
|          | Line transient response              |                              | 11, 13       |
|          | Load transient response              |                              | 12, 14       |
|          | Compensation series resistance (CSR) | vs Output current            | 15, 17       |
|          |                                      | vs Added ceramic capacitance | 16, 18       |

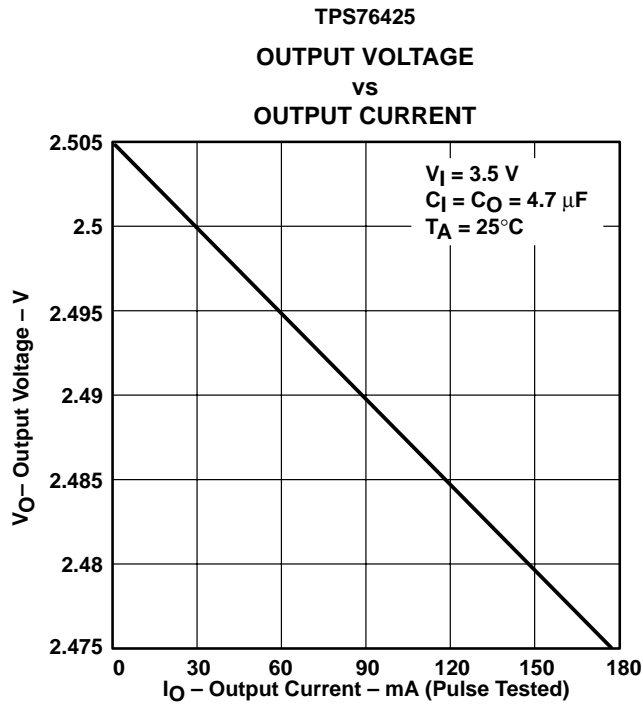

Figure 1

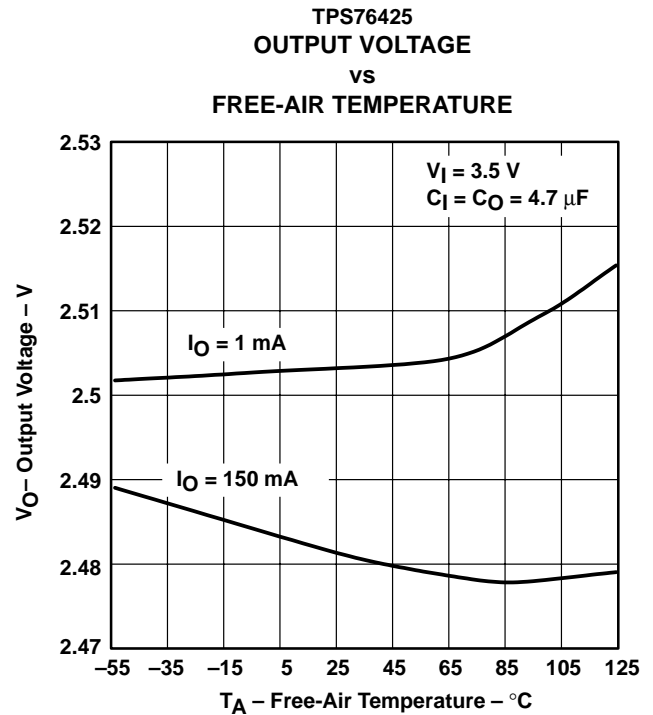

Figure 2

# TPS76425, TPS76427, TPS76428, TPS76430, TPS76433

## LOW-POWER LOW-NOISE 150-mA LOW-DROPOUT LINEAR REGULATORS

SLVS180B – MARCH 1999 – REVISED MAY 2001

### TYPICAL CHARACTERISTICS

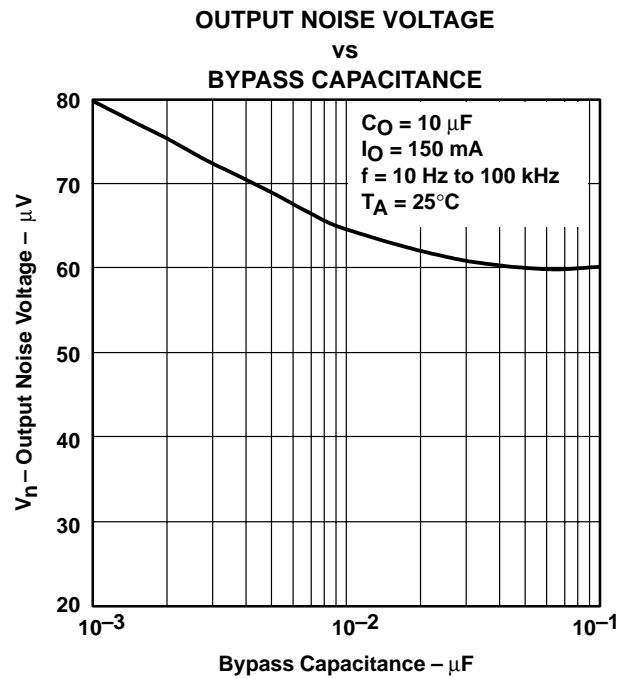
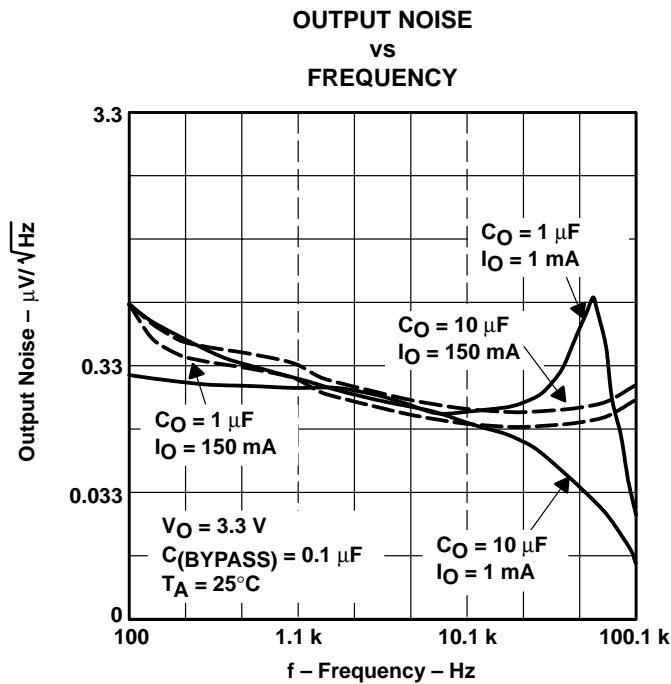
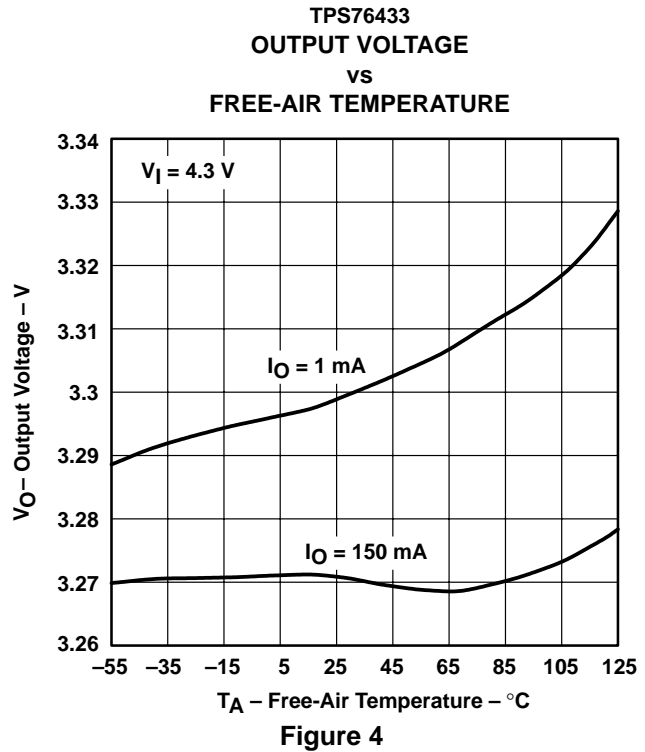
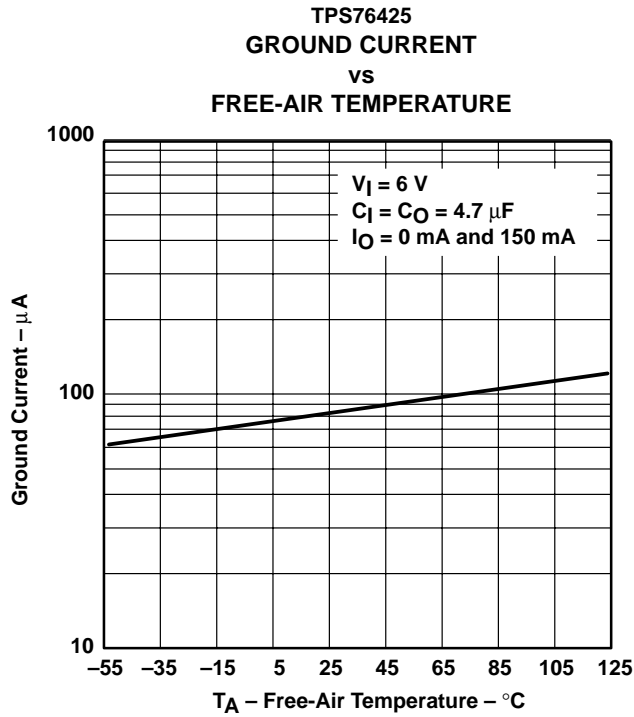

TYPICAL CHARACTERISTICS

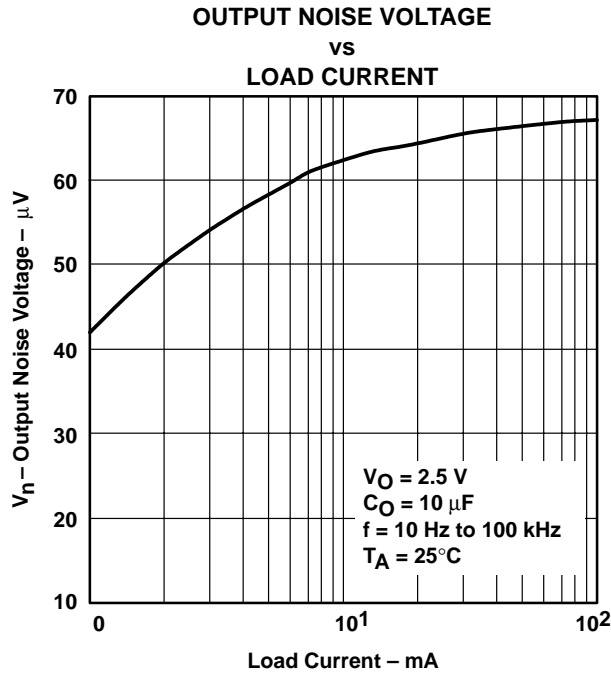

Figure 7

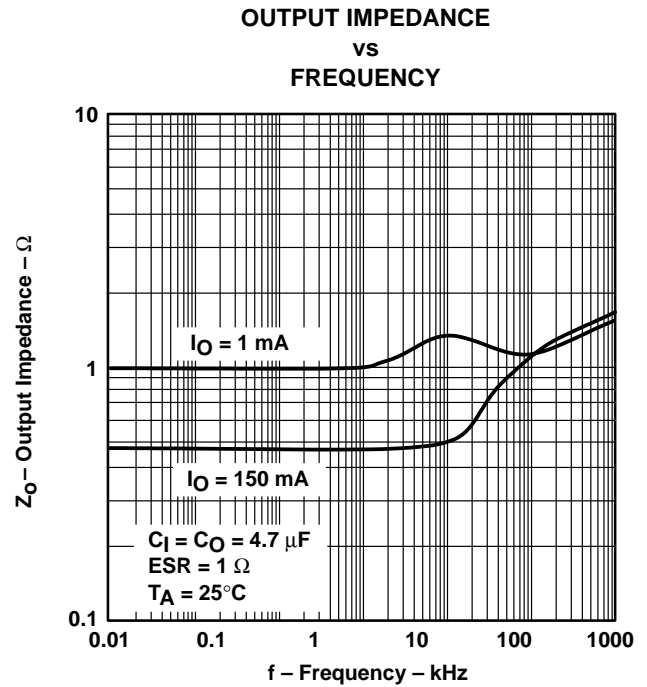

Figure 8

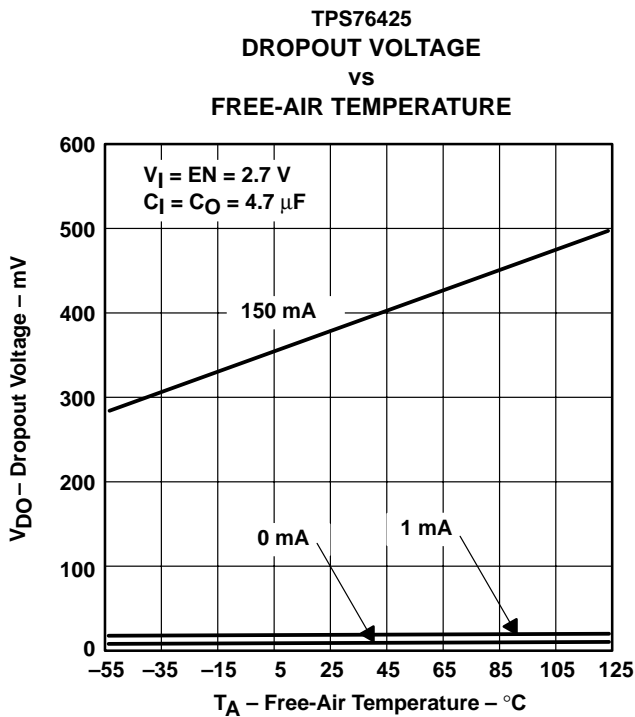

Figure 9

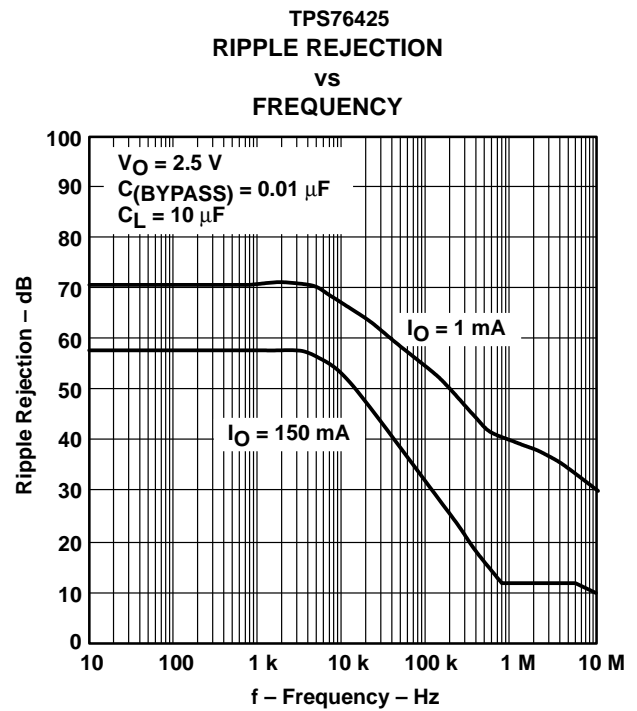

Figure 10

# TPS76425, TPS76427, TPS76428, TPS76430, TPS76433

## LOW-POWER LOW-NOISE 150-mA LOW-DROPOUT LINEAR REGULATORS

SLVS180B – MARCH 1999 – REVISED MAY 2001

### TYPICAL CHARACTERISTICS

**TPS76425**  
**LINE TRANSIENT RESPONSE**

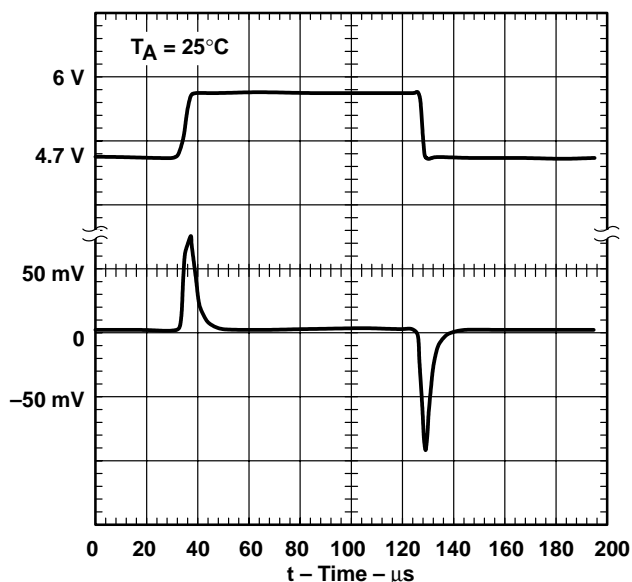

**Figure 11**

**TPS76425**  
**LOAD TRANSIENT RESPONSE**

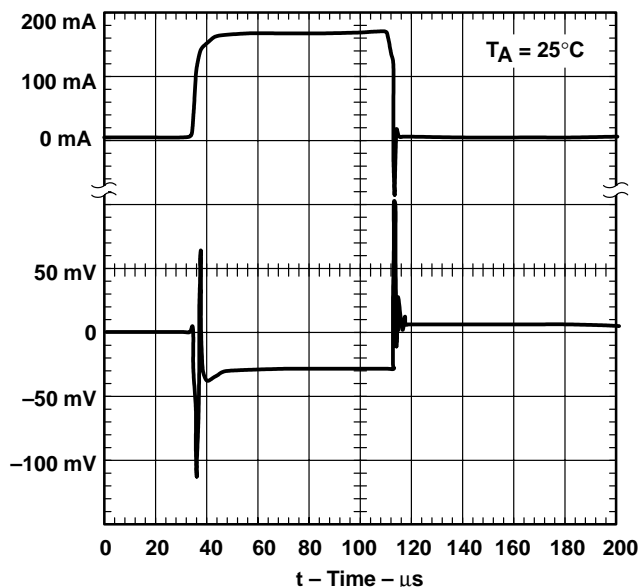

**Figure 12**

**TPS76433**  
**LINE TRANSIENT RESPONSE**

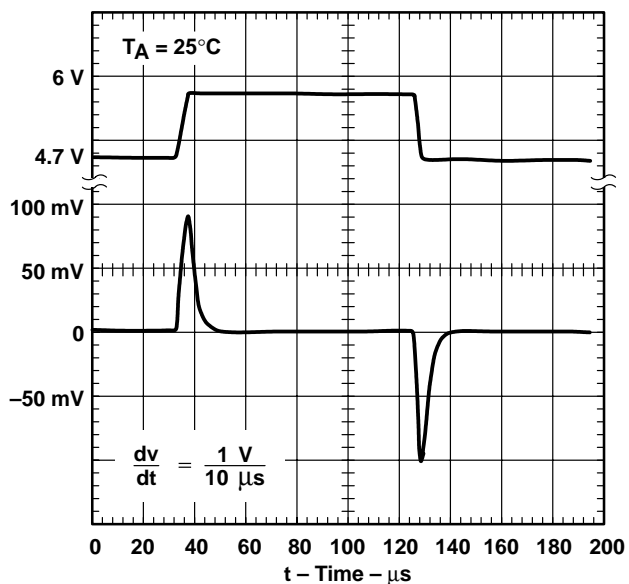

**Figure 13**

**TPS76433**  
**LOAD TRANSIENT RESPONSE**

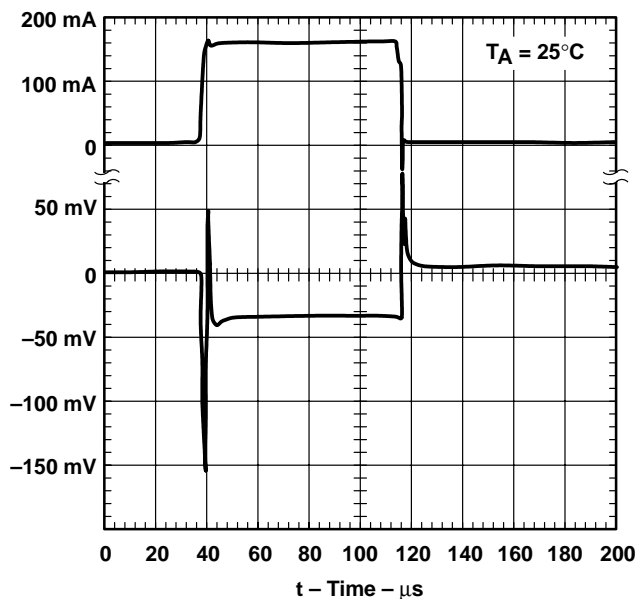

**Figure 14**

TYPICAL CHARACTERISTICS

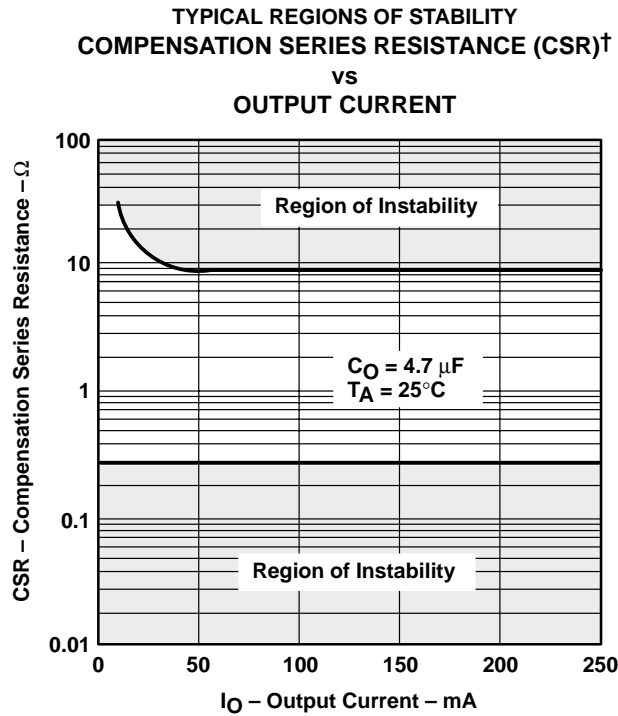

Figure 15

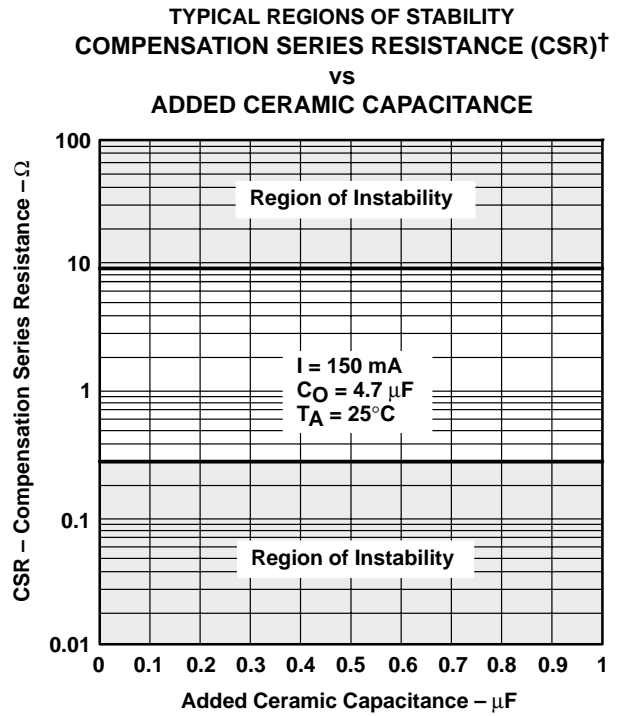

Figure 16

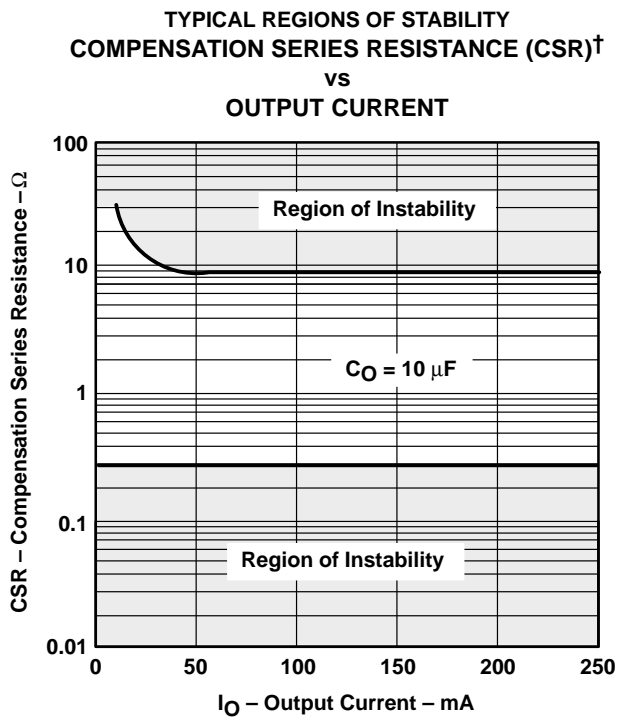

Figure 17

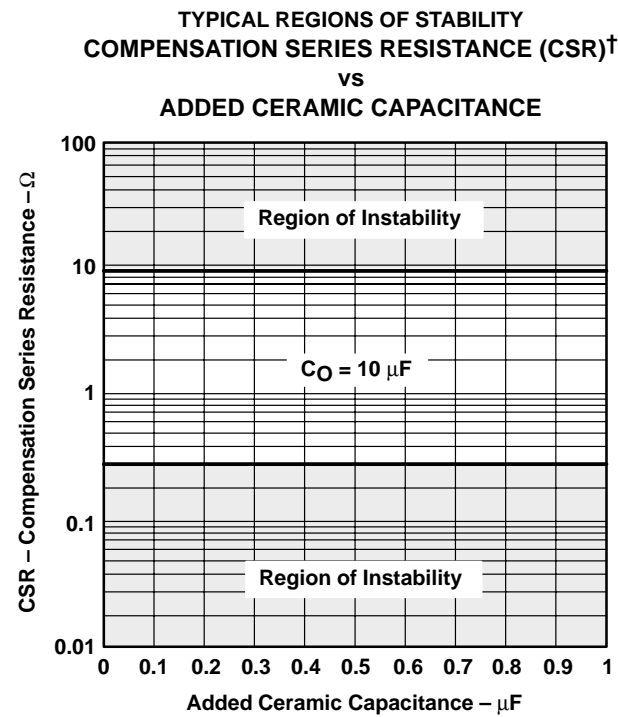

Figure 18

<sup>†</sup> CSR refers to the total series resistance, including the ESR of the capacitor, any series resistance added externally, and PWB trace resistance to  $C_O$ .

# TPS76425, TPS76427, TPS76428, TPS76430, TPS76433 LOW-POWER LOW-NOISE 150-mA LOW-DROPOUT LINEAR REGULATORS

SLVS180B – MARCH 1999 – REVISED MAY 2001

## APPLICATION INFORMATION

The TPS764xx family of low-noise and low-dropout (LDO) regulators are optimized for use in battery-operated equipment. They feature extremely low noise (50  $\mu\text{V}$ ), low dropout voltages, low quiescent current (140  $\mu\text{A}$ ), and an enable input to reduce supply current to less than 2  $\mu\text{A}$  when the regulator is turned off.

### device operation

The TPS764xx uses a PMOS pass element to dramatically reduce both dropout voltage and supply current over more conventional PNP-pass-element LDO designs. The PMOS pass element is a voltage-controlled device which, unlike a PNP transistor, does not require increased drive current as output current increases. Supply current in the TPS764xx is essentially constant from no-load to maximum load.

Current limiting and thermal protection prevent damage by excessive output current and/or power dissipation. The device switches into a constant-current mode at approximately 1 A; further load reduces the output voltage instead of increasing the output current. The thermal protection shuts the regulator off if the junction temperature rises above 165°C. Recovery is automatic when the junction temperature drops approximately 25°C below the high temperature trip point. The PMOS pass element includes a back diode that safely conducts reverse current when the input voltage level drops below the output voltage level.

An internal resistor, in conjunction with external 0.01- $\mu\text{F}$  bypass capacitor, creates a low-pass filter to further reduce the noise. The TPS764xx exhibits only 50  $\mu\text{V}$  of output voltage noise using 0.01  $\mu\text{F}$  bypass and 4.7- $\mu\text{F}$  output capacitors.

A logic low on the enable input, EN, shuts off the output and reduces the supply current to less than 2  $\mu\text{A}$ . EN should be tied high in applications where the shutdown feature is not used.

A typical application circuit is shown in Figure 19.

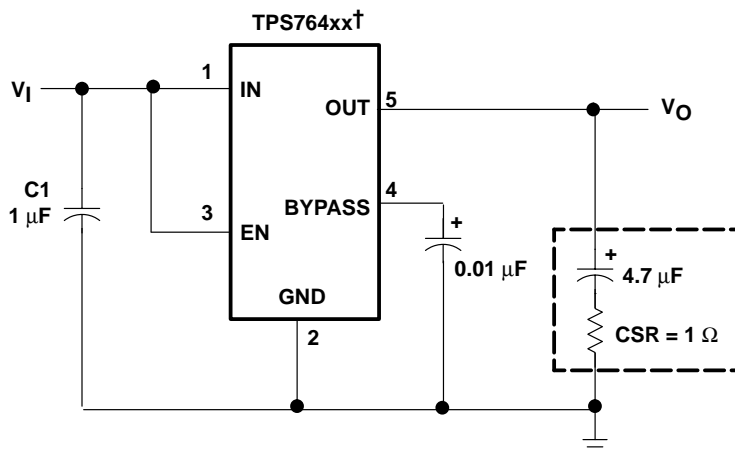

† TPS76425, TPS76427, TPS76430, TPS76433.

Figure 19. Typical Application Circuit

# TPS76425, TPS76427, TPS76428, TPS76430, TPS76433 LOW-POWER LOW-NOISE 150-mA LOW-DROPOUT LINEAR REGULATORS

SLVS180B – MARCH 1999 – REVISED MAY 2001

## APPLICATION INFORMATION

### external capacitor requirements

Although not required, a 0.047- $\mu\text{F}$  or larger ceramic bypass input capacitor, connected between IN and GND and located close to the TPS764xx, is recommended to improve transient response and noise rejection. A higher-value electrolytic input capacitor may be necessary if large, fast-rise-time load transients are anticipated and the device is located several inches from the power source.

Like all low dropout regulators, the TPS764xx requires an output capacitor connected between OUT and GND to stabilize the internal loop control. The minimum recommended capacitance value is 4.7  $\mu\text{F}$  and the ESR (equivalent series resistance) must be between 0.2  $\Omega$  and 10  $\Omega$ . Capacitor values 4.7  $\mu\text{F}$  or larger are acceptable, provided the ESR is less than 10  $\Omega$ . Solid tantalum electrolytic, aluminum electrolytic, and multilayer ceramic capacitors are all suitable, provided they meet the requirements described above. Most of the commercially available 4.7  $\mu\text{F}$  surface-mount solid tantalum capacitors, including devices from Sprague, Kemet, and Nichico, meet the ESR requirements previously stated. Multilayer ceramic capacitors should have minimum values of 1  $\mu\text{F}$  over the full operating temperature range of the equipment.

### CAPACITOR SELECTION

| PART NO.         | MFR.    | VALUE             | MAX ESR†     | SIZE (H × L × W)† |
|------------------|---------|-------------------|--------------|-------------------|
| T494B475K016AS   | KEMET   | 4.7 $\mu\text{F}$ | 1.5 $\Omega$ | 1.9 × 3.5 × 2.8   |
| 195D106x0016x2T  | SPRAGUE | 10 $\mu\text{F}$  | 1.5 $\Omega$ | 1.3 × 7.0 × 2.7   |
| 695D106x003562T  | SPRAGUE | 10 $\mu\text{F}$  | 1.3 $\Omega$ | 2.5 × 7.6 × 2.5   |
| TPSC475K035R0600 | AVX     | 4.7 $\mu\text{F}$ | 0.6 $\Omega$ | 2.6 × 6.0 × 3.2   |

† Size is in mm. ESR is maximum resistance in ohms at 100 kHz and  $T_A = 25^\circ\text{C}$ . Listings are sorted by height.

# TPS76425, TPS76427, TPS76428, TPS76430, TPS76433 LOW-POWER LOW-NOISE 150-mA LOW-DROPOUT LINEAR REGULATORS

SLVS180B – MARCH 1999 – REVISED MAY 2001

---

## APPLICATION INFORMATION

### power dissipation and junction temperature

Specified regulator operation is assured to a junction temperature of 125°C; the maximum junction temperature allowable without damaging the device is 150°C. This restriction limits the power dissipation the regulator can handle in any given application. To ensure the junction temperature is within acceptable limits, calculate the maximum allowable dissipation,  $P_{D(max)}$ , and the actual dissipation,  $P_D$ , which must be less than or equal to  $P_{D(max)}$ .

The maximum-power-dissipation limit is determined using the following equation:

$$P_{D(max)} = \frac{T_{Jmax} - T_A}{R_{\theta JA}}$$

Where:

$T_{Jmax}$  is the maximum allowable junction temperature

$R_{\theta JA}$  is the thermal resistance junction-to-ambient for the package, see the dissipation rating table.

$T_A$  is the ambient temperature.

The regulator dissipation is calculated using:

$$P_D = (V_I - V_O) \times I_O$$

Power dissipation resulting from quiescent current is negligible.

### regulator protection

The TPS764xx pass element has a built-in back diode that safely conducts reverse current when the input voltage drops below the output voltage (e.g., during power down). Current is conducted from the output to the input and is not internally limited. If extended reverse voltage is anticipated, external limiting might be appropriate.

The TPS764xx also features internal current limiting and thermal protection. During normal operation, the TPS764xx limits output current to approximately 800 mA. When current limiting engages, the output voltage scales back linearly until the overcurrent condition ends. While current limiting is designed to prevent gross device failure, care should be taken not to exceed the power dissipation ratings of the package. If the temperature of the device exceeds 165°C, thermal-protection circuitry shuts it down. Once the device has cooled down to below 140°C, regulator operation resumes.



POST OFFICE BOX 655303 • DALLAS, TEXAS 75265

TPS76425, TPS76427, TPS76428, TPS76430, TPS76433  
 LOW-POWER LOW-NOISE 150-mA LOW-DROPOUT LINEAR REGULATORS

SLVS180B – MARCH 1999 – REVISED MAY 2001

MECHANICAL DATA

DBV (R-PDSO-G5)

PLASTIC SMALL-OUTLINE

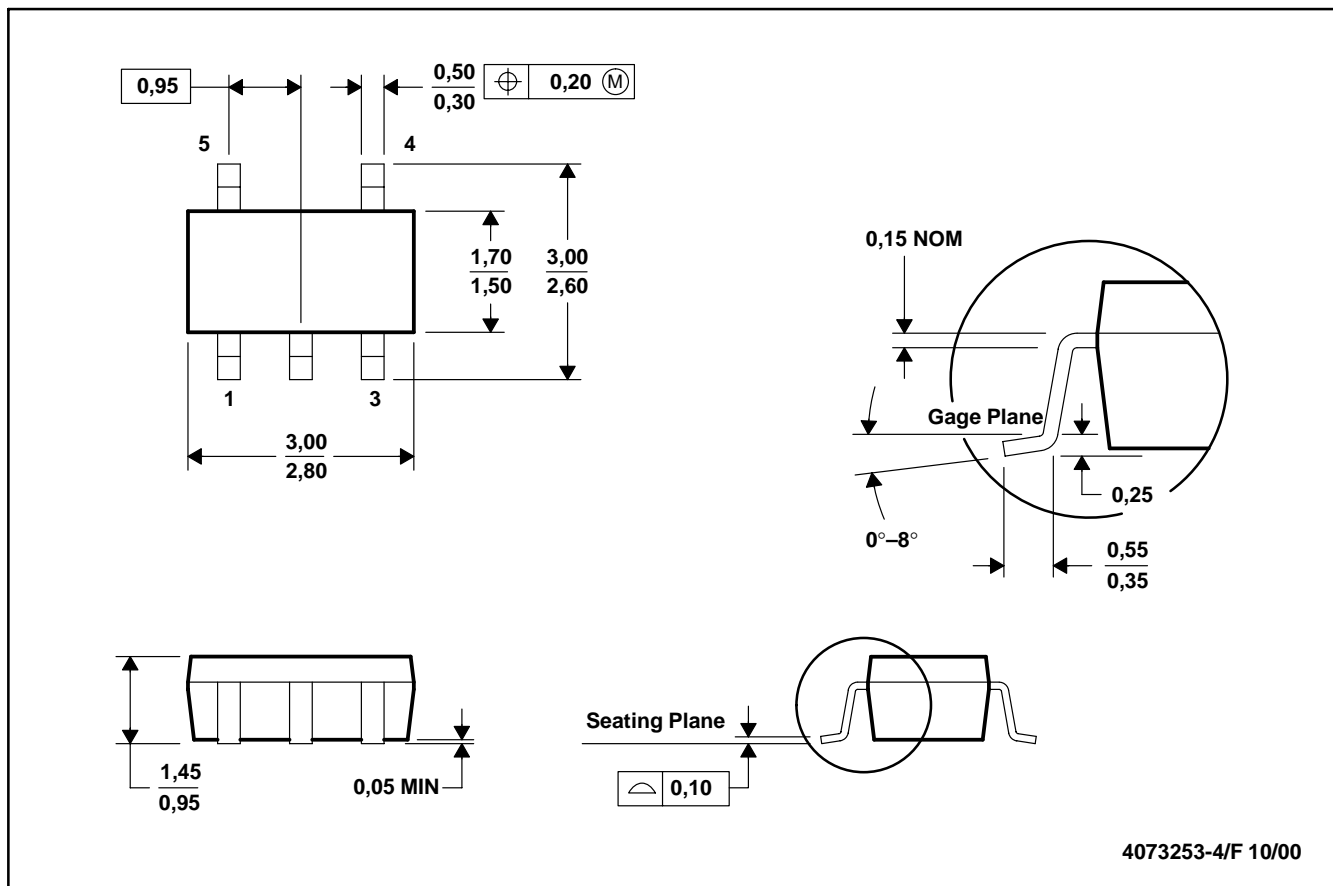

- NOTES: A. All linear dimensions are in millimeters.  
 B. This drawing is subject to change without notice.  
 C. Body dimensions do not include mold flash or protrusion.  
 D. Falls within JEDEC MO-178

**PACKAGING INFORMATION**

| Orderable Device | Status <sup>(1)</sup> | Package Type | Package Drawing | Pins | Package Qty | Eco Plan <sup>(2)</sup> | Lead/Ball Finish | MSL Peak Temp <sup>(3)</sup> |
|------------------|-----------------------|--------------|-----------------|------|-------------|-------------------------|------------------|------------------------------|
| TPS76425DBVR     | ACTIVE                | SOT-23       | DBV             | 5    | 3000        | Green (RoHS & no Sb/Br) | CU NIPDAU        | Level-1-260C-UNLIM           |
| TPS76425DBVRG4   | ACTIVE                | SOT-23       | DBV             | 5    | 3000        | Green (RoHS & no Sb/Br) | CU NIPDAU        | Level-1-260C-UNLIM           |
| TPS76425DBVT     | ACTIVE                | SOT-23       | DBV             | 5    | 250         | Green (RoHS & no Sb/Br) | CU NIPDAU        | Level-1-260C-UNLIM           |
| TPS76425DBVTG4   | ACTIVE                | SOT-23       | DBV             | 5    | 250         | Green (RoHS & no Sb/Br) | CU NIPDAU        | Level-1-260C-UNLIM           |
| TPS76427DBVR     | ACTIVE                | SOT-23       | DBV             | 5    | 3000        | Green (RoHS & no Sb/Br) | CU NIPDAU        | Level-1-260C-UNLIM           |
| TPS76427DBVRG4   | ACTIVE                | SOT-23       | DBV             | 5    | 3000        | Green (RoHS & no Sb/Br) | CU NIPDAU        | Level-1-260C-UNLIM           |
| TPS76427DBVT     | ACTIVE                | SOT-23       | DBV             | 5    | 250         | Green (RoHS & no Sb/Br) | CU NIPDAU        | Level-1-260C-UNLIM           |
| TPS76427DBVTG4   | ACTIVE                | SOT-23       | DBV             | 5    | 250         | Green (RoHS & no Sb/Br) | CU NIPDAU        | Level-1-260C-UNLIM           |
| TPS76428DBV      | OBSOLETE              | SOT-23       | DBV             | 5    |             | TBD                     | Call TI          | Call TI                      |
| TPS76428DBVR     | ACTIVE                | SOT-23       | DBV             | 5    | 3000        | Green (RoHS & no Sb/Br) | CU NIPDAU        | Level-1-260C-UNLIM           |
| TPS76428DBVRG4   | ACTIVE                | SOT-23       | DBV             | 5    | 3000        | Green (RoHS & no Sb/Br) | CU NIPDAU        | Level-1-260C-UNLIM           |
| TPS76428DBVT     | ACTIVE                | SOT-23       | DBV             | 5    | 250         | Green (RoHS & no Sb/Br) | CU NIPDAU        | Level-1-260C-UNLIM           |
| TPS76428DBVTG4   | ACTIVE                | SOT-23       | DBV             | 5    | 250         | Green (RoHS & no Sb/Br) | CU NIPDAU        | Level-1-260C-UNLIM           |
| TPS76430DBVR     | ACTIVE                | SOT-23       | DBV             | 5    | 3000        | Green (RoHS & no Sb/Br) | CU NIPDAU        | Level-1-260C-UNLIM           |
| TPS76430DBVRG4   | ACTIVE                | SOT-23       | DBV             | 5    | 3000        | Green (RoHS & no Sb/Br) | CU NIPDAU        | Level-1-260C-UNLIM           |
| TPS76430DBVT     | ACTIVE                | SOT-23       | DBV             | 5    | 250         | Green (RoHS & no Sb/Br) | CU NIPDAU        | Level-1-260C-UNLIM           |
| TPS76430DBVTG4   | ACTIVE                | SOT-23       | DBV             | 5    | 250         | Green (RoHS & no Sb/Br) | CU NIPDAU        | Level-1-260C-UNLIM           |
| TPS76433DBVR     | ACTIVE                | SOT-23       | DBV             | 5    | 3000        | Green (RoHS & no Sb/Br) | CU NIPDAU        | Level-1-260C-UNLIM           |
| TPS76433DBVRG4   | ACTIVE                | SOT-23       | DBV             | 5    | 3000        | Green (RoHS & no Sb/Br) | CU NIPDAU        | Level-1-260C-UNLIM           |
| TPS76433DBVT     | ACTIVE                | SOT-23       | DBV             | 5    | 250         | Green (RoHS & no Sb/Br) | CU NIPDAU        | Level-1-260C-UNLIM           |
| TPS76433DBVTG4   | ACTIVE                | SOT-23       | DBV             | 5    | 250         | Green (RoHS & no Sb/Br) | CU NIPDAU        | Level-1-260C-UNLIM           |

<sup>(1)</sup> The marketing status values are defined as follows:

**ACTIVE:** Product device recommended for new designs.

**LIFEBUY:** TI has announced that the device will be discontinued, and a lifetime-buy period is in effect.

**NRND:** Not recommended for new designs. Device is in production to support existing customers, but TI does not recommend using this part in a new design.

**PREVIEW:** Device has been announced but is not in production. Samples may or may not be available.

**OBSOLETE:** TI has discontinued the production of the device.

<sup>(2)</sup> Eco Plan - The planned eco-friendly classification: Pb-Free (RoHS), Pb-Free (RoHS Exempt), or Green (RoHS & no Sb/Br) - please check

<http://www.ti.com/productcontent> for the latest availability information and additional product content details.

**TBD:** The Pb-Free/Green conversion plan has not been defined.

**Pb-Free (RoHS):** TI's terms "Lead-Free" or "Pb-Free" mean semiconductor products that are compatible with the current RoHS requirements for all 6 substances, including the requirement that lead not exceed 0.1% by weight in homogeneous materials. Where designed to be soldered at high temperatures, TI Pb-Free products are suitable for use in specified lead-free processes.

**Pb-Free (RoHS Exempt):** This component has a RoHS exemption for either 1) lead-based flip-chip solder bumps used between the die and package, or 2) lead-based die adhesive used between the die and leadframe. The component is otherwise considered Pb-Free (RoHS compatible) as defined above.

**Green (RoHS & no Sb/Br):** TI defines "Green" to mean Pb-Free (RoHS compatible), and free of Bromine (Br) and Antimony (Sb) based flame retardants (Br or Sb do not exceed 0.1% by weight in homogeneous material)

<sup>(3)</sup> MSL, Peak Temp. -- The Moisture Sensitivity Level rating according to the JEDEC industry standard classifications, and peak solder temperature.

**Important Information and Disclaimer:**The information provided on this page represents TI's knowledge and belief as of the date that it is provided. TI bases its knowledge and belief on information provided by third parties, and makes no representation or warranty as to the accuracy of such information. Efforts are underway to better integrate information from third parties. TI has taken and continues to take reasonable steps to provide representative and accurate information but may not have conducted destructive testing or chemical analysis on incoming materials and chemicals. TI and TI suppliers consider certain information to be proprietary, and thus CAS numbers and other limited information may not be available for release.

In no event shall TI's liability arising out of such information exceed the total purchase price of the TI part(s) at issue in this document sold by TI to Customer on an annual basis.

**TAPE AND REEL INFORMATION**

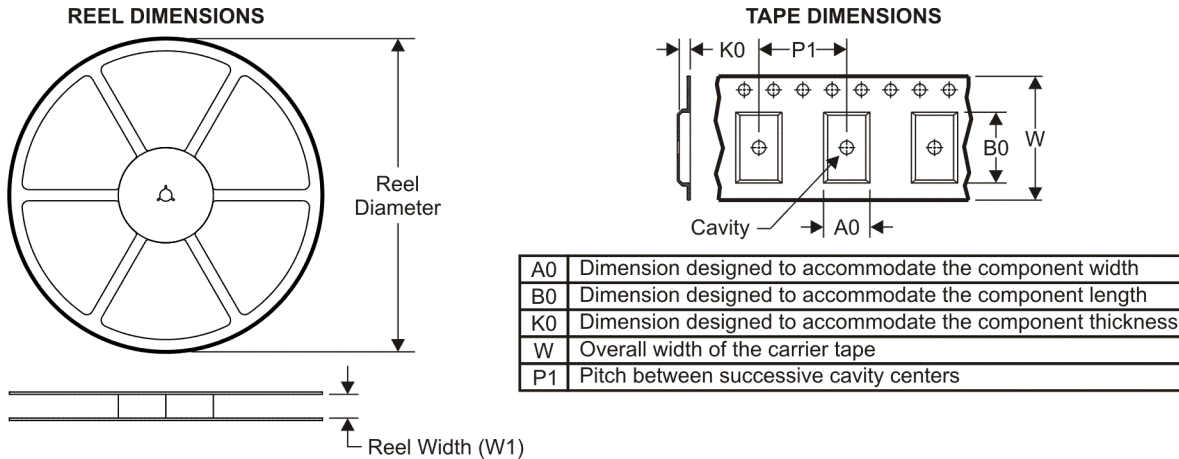

**QUADRANT ASSIGNMENTS FOR PIN 1 ORIENTATION IN TAPE**

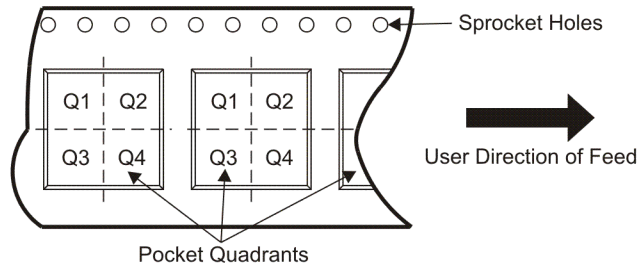

\*All dimensions are nominal

| Device       | Package Type | Package Drawing | Pins | SPQ  | Reel Diameter (mm) | Reel Width W1 (mm) | A0 (mm) | B0 (mm) | K0 (mm) | P1 (mm) | W (mm) | Pin1 Quadrant |
|--------------|--------------|-----------------|------|------|--------------------|--------------------|---------|---------|---------|---------|--------|---------------|
| TPS76425DBVR | SOT-23       | DBV             | 5    | 3000 | 180.0              | 9.0                | 3.15    | 3.2     | 1.4     | 4.0     | 8.0    | Q3            |
| TPS76425DBVT | SOT-23       | DBV             | 5    | 250  | 180.0              | 9.0                | 3.15    | 3.2     | 1.4     | 4.0     | 8.0    | Q3            |
| TPS76427DBVR | SOT-23       | DBV             | 5    | 3000 | 180.0              | 9.0                | 3.15    | 3.2     | 1.4     | 4.0     | 8.0    | Q3            |
| TPS76427DBVT | SOT-23       | DBV             | 5    | 250  | 180.0              | 9.0                | 3.15    | 3.2     | 1.4     | 4.0     | 8.0    | Q3            |
| TPS76428DBVR | SOT-23       | DBV             | 5    | 3000 | 180.0              | 9.0                | 3.15    | 3.2     | 1.4     | 4.0     | 8.0    | Q3            |
| TPS76428DBVT | SOT-23       | DBV             | 5    | 250  | 180.0              | 9.0                | 3.15    | 3.2     | 1.4     | 4.0     | 8.0    | Q3            |
| TPS76430DBVR | SOT-23       | DBV             | 5    | 3000 | 180.0              | 9.0                | 3.15    | 3.2     | 1.4     | 4.0     | 8.0    | Q3            |
| TPS76430DBVT | SOT-23       | DBV             | 5    | 250  | 180.0              | 9.0                | 3.15    | 3.2     | 1.4     | 4.0     | 8.0    | Q3            |
| TPS76433DBVR | SOT-23       | DBV             | 5    | 3000 | 180.0              | 9.0                | 3.15    | 3.2     | 1.4     | 4.0     | 8.0    | Q3            |
| TPS76433DBVT | SOT-23       | DBV             | 5    | 250  | 180.0              | 9.0                | 3.15    | 3.2     | 1.4     | 4.0     | 8.0    | Q3            |

**TAPE AND REEL BOX DIMENSIONS**



\*All dimensions are nominal

| Device       | Package Type | Package Drawing | Pins | SPQ  | Length (mm) | Width (mm) | Height (mm) |
|--------------|--------------|-----------------|------|------|-------------|------------|-------------|
| TPS76425DBVR | SOT-23       | DBV             | 5    | 3000 | 182.0       | 182.0      | 20.0        |
| TPS76425DBVT | SOT-23       | DBV             | 5    | 250  | 182.0       | 182.0      | 20.0        |
| TPS76427DBVR | SOT-23       | DBV             | 5    | 3000 | 182.0       | 182.0      | 20.0        |
| TPS76427DBVT | SOT-23       | DBV             | 5    | 250  | 182.0       | 182.0      | 20.0        |
| TPS76428DBVR | SOT-23       | DBV             | 5    | 3000 | 182.0       | 182.0      | 20.0        |
| TPS76428DBVT | SOT-23       | DBV             | 5    | 250  | 182.0       | 182.0      | 20.0        |
| TPS76430DBVR | SOT-23       | DBV             | 5    | 3000 | 182.0       | 182.0      | 20.0        |
| TPS76430DBVT | SOT-23       | DBV             | 5    | 250  | 182.0       | 182.0      | 20.0        |
| TPS76433DBVR | SOT-23       | DBV             | 5    | 3000 | 182.0       | 182.0      | 20.0        |
| TPS76433DBVT | SOT-23       | DBV             | 5    | 250  | 182.0       | 182.0      | 20.0        |

## IMPORTANT NOTICE

Texas Instruments Incorporated and its subsidiaries (TI) reserve the right to make corrections, modifications, enhancements, improvements, and other changes to its products and services at any time and to discontinue any product or service without notice. Customers should obtain the latest relevant information before placing orders and should verify that such information is current and complete. All products are sold subject to TI's terms and conditions of sale supplied at the time of order acknowledgment.

TI warrants performance of its hardware products to the specifications applicable at the time of sale in accordance with TI's standard warranty. Testing and other quality control techniques are used to the extent TI deems necessary to support this warranty. Except where mandated by government requirements, testing of all parameters of each product is not necessarily performed.

TI assumes no liability for applications assistance or customer product design. Customers are responsible for their products and applications using TI components. To minimize the risks associated with customer products and applications, customers should provide adequate design and operating safeguards.

TI does not warrant or represent that any license, either express or implied, is granted under any TI patent right, copyright, mask work right, or other TI intellectual property right relating to any combination, machine, or process in which TI products or services are used. Information published by TI regarding third-party products or services does not constitute a license from TI to use such products or services or a warranty or endorsement thereof. Use of such information may require a license from a third party under the patents or other intellectual property of the third party, or a license from TI under the patents or other intellectual property of TI.

Reproduction of TI information in TI data books or data sheets is permissible only if reproduction is without alteration and is accompanied by all associated warranties, conditions, limitations, and notices. Reproduction of this information with alteration is an unfair and deceptive business practice. TI is not responsible or liable for such altered documentation. Information of third parties may be subject to additional restrictions.

Resale of TI products or services with statements different from or beyond the parameters stated by TI for that product or service voids all express and any implied warranties for the associated TI product or service and is an unfair and deceptive business practice. TI is not responsible or liable for any such statements.

TI products are not authorized for use in safety-critical applications (such as life support) where a failure of the TI product would reasonably be expected to cause severe personal injury or death, unless officers of the parties have executed an agreement specifically governing such use. Buyers represent that they have all necessary expertise in the safety and regulatory ramifications of their applications, and acknowledge and agree that they are solely responsible for all legal, regulatory and safety-related requirements concerning their products and any use of TI products in such safety-critical applications, notwithstanding any applications-related information or support that may be provided by TI. Further, Buyers must fully indemnify TI and its representatives against any damages arising out of the use of TI products in such safety-critical applications.

TI products are neither designed nor intended for use in military/aerospace applications or environments unless the TI products are specifically designated by TI as military-grade or "enhanced plastic." Only products designated by TI as military-grade meet military specifications. Buyers acknowledge and agree that any such use of TI products which TI has not designated as military-grade is solely at the Buyer's risk, and that they are solely responsible for compliance with all legal and regulatory requirements in connection with such use.

TI products are neither designed nor intended for use in automotive applications or environments unless the specific TI products are designated by TI as compliant with ISO/TS 16949 requirements. Buyers acknowledge and agree that, if they use any non-designated products in automotive applications, TI will not be responsible for any failure to meet such requirements.

Following are URLs where you can obtain information on other Texas Instruments products and application solutions:

### Products

|                             |  |
|-----------------------------|--|
| Amplifiers                  | <a href="http://amplifier.ti.com">amplifier.ti.com</a>             |
| Data Converters             | <a href="http://dataconverter.ti.com">dataconverter.ti.com</a>     |
| DSP                         | <a href="http://dsp.ti.com">dsp.ti.com</a>                         |
| Clocks and Timers           | <a href="http://www.ti.com/clocks">www.ti.com/clocks</a>           |
| Interface                   | <a href="http://interface.ti.com">interface.ti.com</a>             |
| Logic                       | <a href="http://logic.ti.com">logic.ti.com</a>                     |
| Power Mgmt                  | <a href="http://power.ti.com">power.ti.com</a>                     |
| Microcontrollers            | <a href="http://microcontroller.ti.com">microcontroller.ti.com</a> |
| RFID                        | <a href="http://www.ti-rfid.com">www.ti-rfid.com</a>               |
| RF/IF and ZigBee® Solutions | <a href="http://www.ti.com/lprf">www.ti.com/lprf</a>               |

### Applications

|                    |  |
|--------------------|--|
| Audio              | <a href="http://www.ti.com/audio">www.ti.com/audio</a>                   |
| Automotive         | <a href="http://www.ti.com/automotive">www.ti.com/automotive</a>         |
| Broadband          | <a href="http://www.ti.com/broadband">www.ti.com/broadband</a>           |
| Digital Control    | <a href="http://www.ti.com/digitalcontrol">www.ti.com/digitalcontrol</a> |
| Medical            | <a href="http://www.ti.com/medical">www.ti.com/medical</a>               |
| Military           | <a href="http://www.ti.com/military">www.ti.com/military</a>             |
| Optical Networking | <a href="http://www.ti.com/opticalnetwork">www.ti.com/opticalnetwork</a> |
| Security           | <a href="http://www.ti.com/security">www.ti.com/security</a>             |
| Telephony          | <a href="http://www.ti.com/telephony">www.ti.com/telephony</a>           |
| Video & Imaging    | <a href="http://www.ti.com/video">www.ti.com/video</a>                   |
| Wireless           | <a href="http://www.ti.com/wireless">www.ti.com/wireless</a>             |

Mailing Address: Texas Instruments, Post Office Box 655303, Dallas, Texas 75265  
Copyright © 2008, Texas Instruments Incorporated

## Looking for pricing, stock, or lifecycle information?

Click below to explore more details on WIN SOURCE:

 [View TPS76425DBVRG4 on WIN SOURCE](#)

 [Texas Instruments](#) Information

## Optimize Your Supply Chain with WIN SOURCE Solutions

-  Global Sourcing Solution
-  Obsolete Management
-  Cost Control Management
-  Shortage Management
-  Alternative Solution
-  Excess Inventory Management