

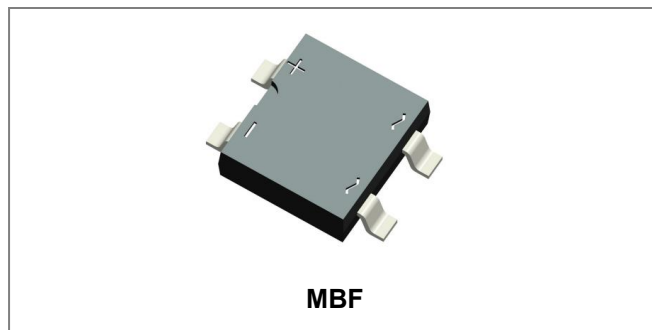

## MB05F THRU MB10F SINGLE PHASE 0.8AMP SURFACE MOUNT GLASS PASSIVATED BRIDGE RECTIFIER



### Features

- Glass passivated die construction
- Low forward voltage drop
- High current capability
- High surge current capability
- Designed for surface mount application
- Plastic material-UL flammability 94V-0
- This is a Pb – Free Device
- “-HF” suffix is for Halogen Free Device
- All SMC parts are traceable to the wafer lot
- Additional testing can be offered upon request

### Circuit Diagram

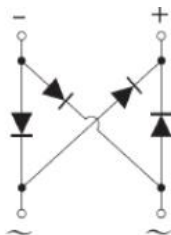

### Mechanical Data

- Case: MBF, Molded plastic
- Terminals: Plated leads solderable per MIL-STD-202, Method 208
- Polarity: as marked on case
- Mounting Position: Any
- Lead Free: For RoHS / Lead Free Version

### Maximum Ratings @ $T_A=25^{\circ}\text{C}$ unless otherwise specified

| Type Number                                                                                                              | Symbol                | MB05F  | MB1F  | MB2F  | MB4F  | MB6F       | MB8F  | MB10F  | Units |
|--------------------------------------------------------------------------------------------------------------------------|-----------------------|--------|-------|-------|-------|------------|-------|--------|-------|
| MB05F-HF THRU MB10F-HF<br>Marking Code                                                                                   |                       | MB05FH | MB1FH | MB2FH | MB4FH | MB6FH      | MB8FH | MB10FH |       |
| Peak Repetitive Reverse Voltage<br>DC Blocking Voltage                                                                   | $V_{RRM}$<br>$V_{DC}$ | 50     | 100   | 200   | 400   | 600        | 800   | 1000   | V     |
| RMS Voltage                                                                                                              | $V_{RMS}$             | 35     | 70    | 140   | 280   | 420        | 480   | 700    | V     |
| Average Rectified Output Current<br>(Note 1)@ $T_A=40^{\circ}\text{C}$<br>(Note 2)@ $T_A=40^{\circ}\text{C}$             | $I_o$                 |        |       |       |       | 0.5<br>0.8 |       |        | A     |
| Non-Repetitive Peak Forward<br>Surge Current 8.3ms Single half<br>sine-wave superimposed on rated<br>load (JEDEC Method) | $I_{FSM}$             |        |       |       |       | 30         |       |        | A     |

**Electrical Characteristics: @T<sub>A</sub>=25°C unless otherwise specified**

| Type Number                                                                                         | Symbol          | MB05F    | MB1F  | MB2F  | MB4F  | MB6F  | MB8F  | MB10F  | Units |
|-----------------------------------------------------------------------------------------------------|-----------------|----------|-------|-------|-------|-------|-------|--------|-------|
| MB05F-HF THRU MB10F-HF Marking Code                                                                 |                 | MB05FH   | MB1FH | MB2FH | MB4FH | MB6FH | MB8FH | MB10FH |       |
| Forward Voltage per element @I <sub>F</sub> =0.8A                                                   | V <sub>FM</sub> | 1.1      |       |       |       |       |       |        | V     |
| Peak Reverse Current @T <sub>A</sub> = 25°C<br>At Rated DC Blocking Voltage @T <sub>A</sub> = 125°C | I <sub>R</sub>  | 5<br>500 |       |       |       |       |       |        | μA    |
| Typical Junction Capacitance (Note 3)                                                               | C <sub>j</sub>  | 13       |       |       |       |       |       |        | pF    |

\* Pulse width < 300 μs, duty cycle < 2%

**Thermal-Mechanical Specifications: @T<sub>A</sub>=25°C unless otherwise specified**

| Type Number                                      | Symbol                            | MB05F   | MB1F  | MB2F  | MB4F  | MB6F  | MB8F  | MB10F  | Units |
|--------------------------------------------------|-----------------------------------|---------|-------|-------|-------|-------|-------|--------|-------|
| MB05F-HF THRU MB10F-HF Marking Code              |                                   | MB05FH  | MB1FH | MB2FH | MB4FH | MB6FH | MB8FH | MB10FH |       |
| Typical Thermal Resistance per leg               | R <sub>θJA</sub>                  | 60      |       |       |       |       |       |        | °C/W  |
|                                                  | R <sub>θJL</sub>                  | 16      |       |       |       |       |       |        |       |
| Operating Junction and Storage Temperature Range | T <sub>J</sub> , T <sub>STG</sub> | -55+150 |       |       |       |       |       |        | °C    |

- Note: 1. Mounted on glass epoxy PC board with 1.3mm<sup>2</sup> solder pad.  
 2. Measured at 1.0 MHz and applied reverse voltage of 4.0V D.C.  
 3. Thermal Resistance From Junction to Ambient

**Ratings and Characteristics Curves**

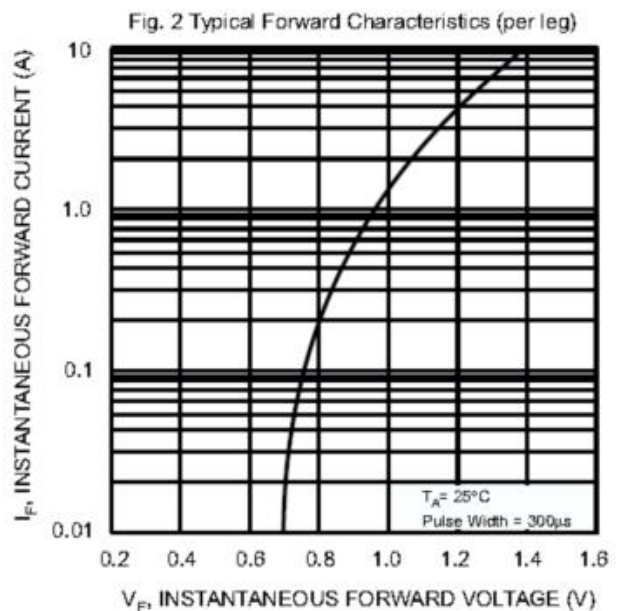
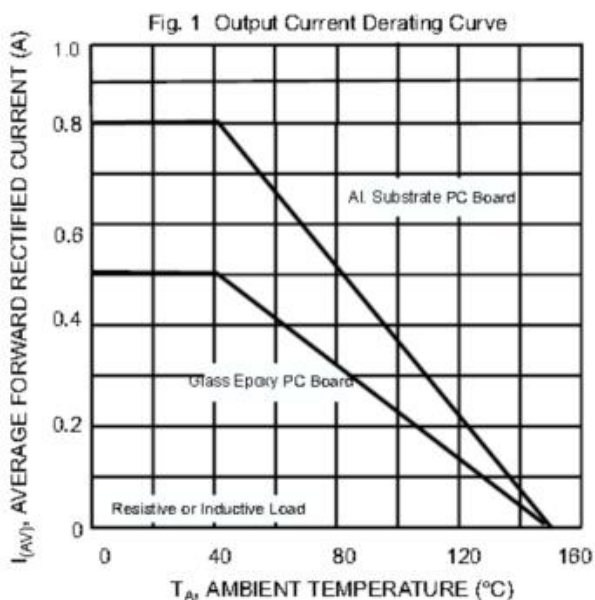

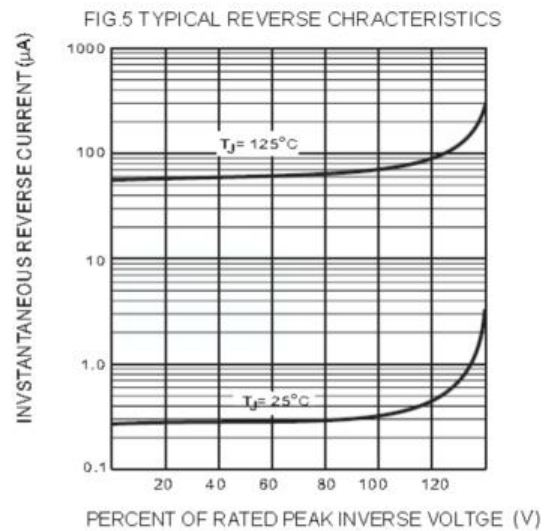
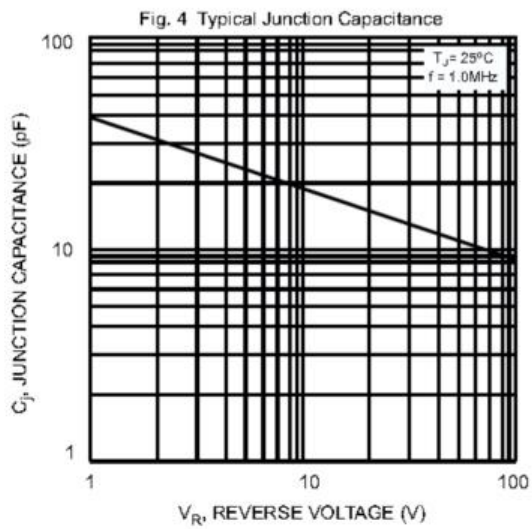
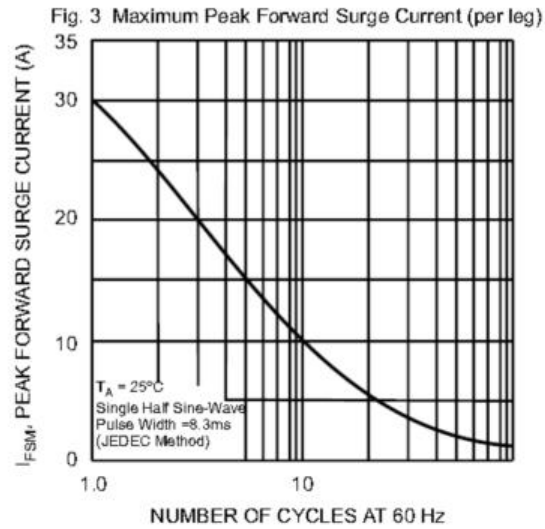

**Ordering Information**

| Device                      | Package | Plating | Shipping       |
|-----------------------------|---------|---------|----------------|
| MB05F<br>THRU<br>MB10F      | MBF     | Pure Sn | 5000pcs / reel |
| MB05FTR<br>THRU<br>MB10F TR | MBF     | Pure Sn | 5000pcs / reel |

For information on tape and reel specifications, including part orientation and tape sizes, please refer to our tape and reel packaging specification.

**Marking Diagram**

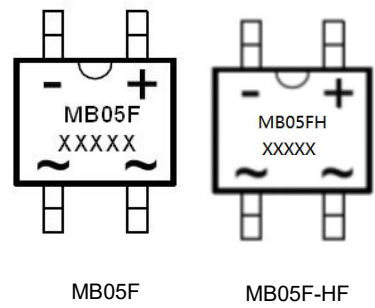

Where XXXXX is YYWWL  
 MB05F = Type Number  
 MB05FH = Marking Code  
 YY = Year  
 WW = Week  
 L = Lot Number

**Cautions:** Molding resin  
 Epoxy resin UL:94V-0

**Mechanical Dimensions MBF(Inches/Millimeters)**

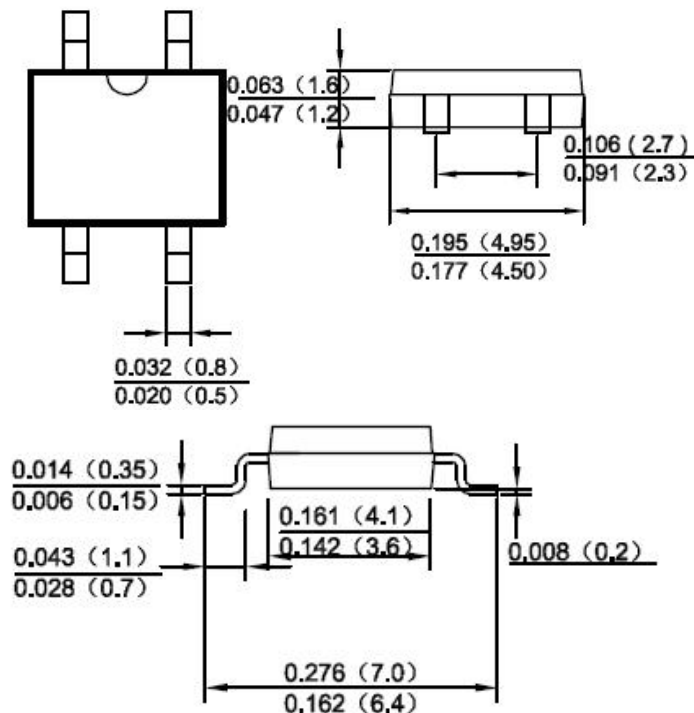

**Carrier Tape & Reel Specification MBF**

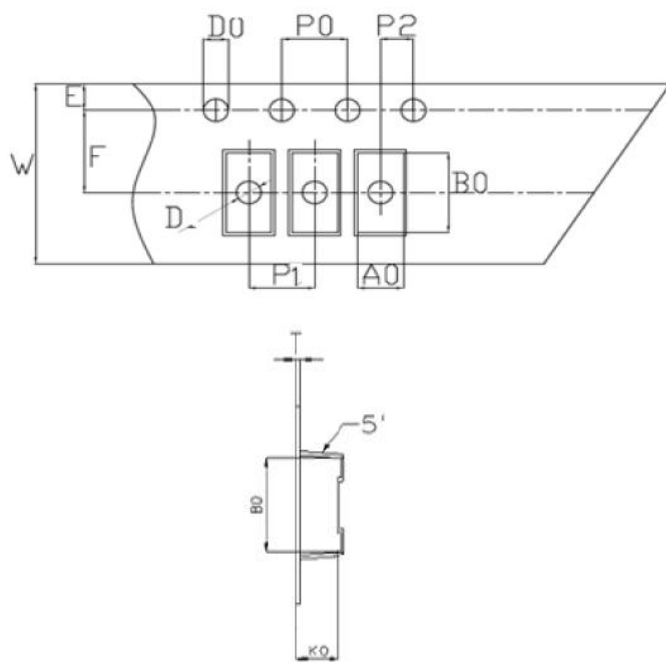

| SYMBOL | Millimeters |       |
|--------|-------------|-------|
|        | Min.        | Max.  |
| A0     | 5.21        | 5.41  |
| B0     | 7.10        | 7.30  |
| D0     | 1.50        | 1.60  |
| D1     | 1.40        | 1.60  |
| P0     | 3.90        | 4.10  |
| P1     | 7.90        | 8.10  |
| P2     | 1.95        | 2.05  |
| E      | 1.65        | 1.85  |
| K0     | 1.55        | 1.75  |
| F      | 5.45        | 5.55  |
| W      | 11.90       | 12.10 |
| T      | 0.24        | 0.30  |
| 10P0   | 39.80       | 40.20 |

**Technical Data  
Data Sheet N1456, Rev. B**





**DISCLAIMER:**

- 1- The information given herein, including the specifications and dimensions, is subject to change without prior notice to improve product characteristics. Before ordering, purchasers are advised to contact the SMC Diode Solutions sales department for the latest version of the datasheet(s).
- 2- In cases where extremely high reliability is required (such as use in nuclear power control, aerospace and aviation, traffic equipment, medical equipment, and safety equipment), safety should be ensured by using semiconductor devices that feature assured safety or by means of users' fail-safe precautions or other arrangement.
- 3- In no event shall SMC Diode Solutions be liable for any damages that may result from an accident or any other cause during operation of the user's units according to the datasheet(s). SMC Diode Solution assumes no responsibility for any intellectual property claims or any other problems that may result from applications of information, products or circuits described in the datasheets.
- 4- In no event shall SMC Diode Solutions be liable for any failure in a semiconductor device or any secondary damage resulting from use at a value exceeding the absolute maximum rating.
- 5- No license is granted by the datasheet(s) under any patents or other rights of any third party or SMC Diode Solutions.
- 6- The datasheet(s) may not be reproduced or duplicated, in any form, in whole or part, without the expressed written permission of SMC Diode Solutions.
- 7- The products (technologies) described in the datasheet(s) are not to be provided to any party whose purpose in their application will hinder maintenance of international peace and safety nor are they to be applied to that purpose by their direct purchasers or any third party. When exporting these products (technologies), the necessary procedures are to be taken in accordance with related laws and regulations.

## Looking for pricing, stock, or lifecycle information?

Click below to explore more details on WIN SOURCE:

-  [View MB2F on WIN SOURCE](#)
-  [SMC Diode Solutions](#) Information

## Optimize Your Supply Chain with WIN SOURCE Solutions

-  Global Sourcing Solution
-  Obsolete Management
-  Cost Control Management
-  Shortage Management
-  Alternative Solution
-  Excess Inventory Management