



**THE DATASHEET OF
LMV393IPWRG4**



LMV331 Single, LMV393 Dual, LMV339 Quad General-purpose Low-voltage Comparators

1 Features

- 2.7-V and 5-V Performance
- Low Supply Current
 - LMV331 130 μ A Typ
 - LMV393 210 μ A Typ
 - LMV339 410 μ A Typ
- Input Common-Mode Voltage Range Includes Ground
- Low Output Saturation Voltage 200 mV Typical
- Open-Collector Output for Maximum Flexibility

2 Applications

- Hysteresis Comparators
- Oscillators
- Window Comparators
- Industrial Equipment
- Test and Measurement

3 Description

The LMV393 and LMV339 devices are low-voltage (2.7 V to 5.5 V) versions of the dual and quad comparators, LM393 and LM339, which operate from 5 V to 30 V. The LMV331 is the single-comparator version.

The LMV331, LMV339, and LMV393 are the most cost-effective solutions for applications where low-voltage operation, low power, and space saving are the primary specifications in circuit design for portable consumer products. These devices offer specifications that meet or exceed the familiar LM339 and LM393 devices at a fraction of the supply current.

Device Information⁽¹⁾

PART NUMBER	PACKAGE (PIN)	BODY SIZE (NOM)
LMV339	SOIC (14)	8.65 mm x 3.90 mm
LMV393	SOIC (8)	4.90 mm x 3.90 mm
LMV331	SC70 (5)	2.00 mm x 1.25 mm

(1) For all available packages, see the orderable addendum at the end of the datasheet.

4 Simplified Schematic

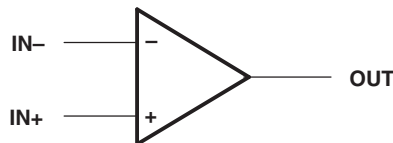

Table of Contents

1 Features	1	8.1 Overview	9
2 Applications	1	8.2 Functional Block Diagram	9
3 Description	1	8.3 Feature Description	9
4 Simplified Schematic	1	8.4 Device Functional Modes	9
5 Revision History	2	9 Application and Implementation	10
6 Pin Configuration and Functions	3	9.1 Application Information	10
7 Specifications	4	9.2 Typical Application	10
7.1 Absolute Maximum Ratings	4	10 Power Supply Recommendations	12
7.2 ESD Ratings	4	11 Layout	12
7.3 Recommended Operating Conditions	4	11.1 Layout Guidelines	12
7.4 Thermal Information	4	11.2 Layout Example	12
7.5 Electrical Characteristics, $V_{CC+} = 2.7\text{ V}$	5	12 Device and Documentation Support	13
7.6 Electrical Characteristics, $V_{CC+} = 5\text{ V}$	6	12.1 Related Links	13
7.7 Switching Characteristics, $V_{CC+} = 2.7\text{ V}$	6	12.2 Trademarks	13
7.8 Switching Characteristics, $V_{CC+} = 5\text{ V}$	6	12.3 Electrostatic Discharge Caution	13
7.9 Typical Characteristics	7	12.4 Glossary	13
8 Detailed Description	9	13 Mechanical, Packaging, and Orderable Information	13

5 Revision History

Changes from Revision S (October 2012) to Revision T

Page

- Added *Applications*, *Device Information* table, *Pin Functions* table, *ESD Ratings* table, *Thermal Information* table, *Typical Characteristics*, *Feature Description* section, *Device Functional Modes*, *Application and Implementation* section, *Power Supply Recommendations* section, *Layout* section, *Device and Documentation Support* section, and *Mechanical, Packaging, and Orderable Information* section. **1**
- Deleted *Ordering Information* table. **1**

Changes from Revision R (May 2012) to Revision S

Page

- Updated operating temperature range. **4**

Changes from Revision N (April 2011) to Revision O

Page

- Changed V_I in the *Absolute Maximum Ratings* from 5.5 V to V_{CC+} **4**

Changes from Revision M (November 2005) to Revision N

Page

- Changed document format from Quicksilver to DocZone. **1**
- Added RUC package pin out drawing. **3**

6 Pin Configuration and Functions

LMV339 . . . D OR PW PACKAGE
(TOP VIEW)

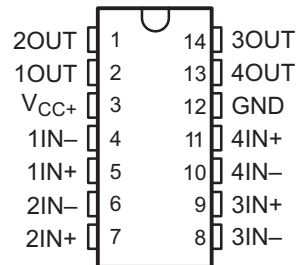

LMV339 . . . RUC PACKAGE
(TOP VIEW)

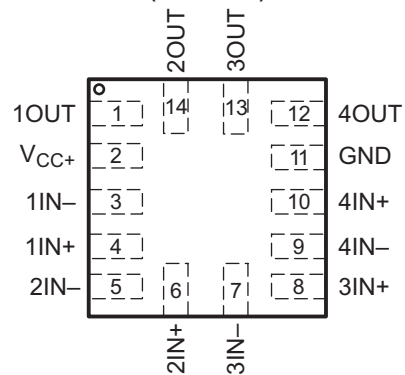

LMV393 . . . D, DDU, DGK OR PW PACKAGE
(TOP VIEW)

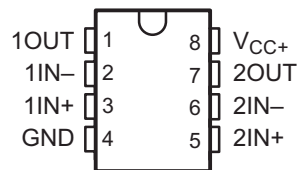

LMV331 . . . DBV OR DCK PACKAGE
(TOP VIEW)

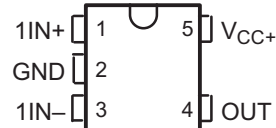

Pin Functions

NAME	PIN				TYPE	DESCRIPTION
	LMV331 DBV or DCK	LMV393 D, DDU, DGK or PW	LMV339 D or PW RUC			
1IN-, 2IN-, 3IN-, 4IN-	3	2, 6	4, 6, 8, 10	3, 5, 7, 9	I	Comparator(s) negative input pin(s)
1IN+, 2IN+, 3IN+, 4IN+	1	3, 5	5, 7, 9, 11	4, 6, 8, 10	I	Comparator(s) positive input pin(s)
GND	2	4	12	11	I	Ground
1OUT, 2OUT, 3OUT, 4OUT	4	1, 7	2, 1, 14, 13	1, 14, 13, 12	O	Comparator(s) output pin(s)
VCC+	5	8	3	2	I	Supply Pin

7 Specifications

7.1 Absolute Maximum Ratings

over operating free-air temperature range (unless otherwise noted)⁽¹⁾

		MIN	MAX	UNIT
V _{CC}	Supply voltage ⁽²⁾		5.5	V
V _{ID}	Differential input voltage ⁽³⁾		±5.5	V
V _I	Input voltage range (either input)	0	V _{CC+}	V
	Duration of output short circuit (one amplifier) to ground ⁽⁴⁾	At or below T _A = 25°C, V _{CC} ≤ 5.5 V		Unlimited
T _J	Operating virtual junction temperature		150	°C
T _{stg}	Storage temperature range	–65	150	°C

- (1) Stresses beyond those listed under *Absolute Maximum Ratings* may cause permanent damage to the device. These are stress ratings only, and functional operation of the device at these or any other conditions beyond those indicated under *Recommended Operating Conditions* is not implied. Exposure to absolute-maximum-rated conditions for extended periods may affect device reliability.
- (2) All voltage values (except differential voltages and V_{CC} specified for the measurement of I_{OS}) are with respect to the network GND.
- (3) Differential voltages are at IN+ with respect to IN–.
- (4) Short circuits from outputs to V_{CC} can cause excessive heating and eventual destruction.

7.2 ESD Ratings

			VALUE	UNIT
V _(ESD)	Electrostatic discharge	Human body model (HBM), per ANSI/ESDA/JEDEC JS-001, all pins ⁽¹⁾	±2000	V
		Charged device model (CDM), per JEDEC specification JESD22-C101, all pins ⁽²⁾	±1000	

- (1) JEDEC document JEP155 states that 500-V HBM allows safe manufacturing with a standard ESD control process.
- (2) JEDEC document JEP157 states that 250-V CDM allows safe manufacturing with a standard ESD control process.

7.3 Recommended Operating Conditions

		MIN	MAX	UNIT
V _{CC}	Supply voltage (single-supply operation)	2.7	5.5	V
V _{OUT}	Output voltage		V _{CC+} + 0.3	V
T _A	Operating free-air temperature	–40	125	°C

7.4 Thermal Information

THERMAL METRIC ⁽¹⁾	LMV339			LMV393				LMV331		UNIT	
	D	PW	RUC	D	DDU	DGK	PW	DBV	DCK		
	14 PINS			8 PINS				5 PINS			
R _{θJA}	Junction-to-ambient thermal resistance	86	113	216	97	210	172	149	206	252	°C/W
R _{θJC(top)}	Junction-to-case (top) thermal resistance	—	—	51.3	—	—	—	—	—	—	
R _{θJB}	Junction-to-board thermal resistance	—	—	59.0	—	—	—	—	—	—	
Ψ _{JT}	Junction-to-top characterization parameter	—	—	1.2	—	—	—	—	—	—	
Ψ _{JB}	Junction-to-board characterization parameter	—	—	59.0	—	—	—	—	—	—	

- (1) For more information about traditional and new thermal metrics, see the *IC Package Thermal Metrics* application report, [SPRA953](#).

7.5 Electrical Characteristics, $V_{CC+} = 2.7\text{ V}$

$V_{CC+} = 2.7\text{ V}$, $GND = 0\text{ V}$, at specified free-air temperature (unless otherwise noted)

PARAMETER	TEST CONDITIONS	T_A	MIN	TYP	MAX	UNIT	
V_{IO}	Input offset voltage	25°C		1.7	7	mV	
α_{VIO}	Average temperature coefficient of input offset voltage	–40°C to 125°C		5		$\mu\text{V}/^\circ\text{C}$	
I_{IB}	Input bias current	25°C		15	250	nA	
		–40°C to 125°C			400		
I_{IO}	Input offset current	25°C		5	50	nA	
		–40°C to 125°C			150		
I_O	Output current (sinking)	$V_O \leq 1.5\text{ V}$	25°C	5	23	mA	
	Output Leakage Current	25°C		0.003		μA	
		–40°C to 125°C			1		
V_{ICR}	Common-mode input voltage range	25°C		–0.1 to 2		V	
V_{SAT}	Saturation voltage	$I_O \leq 1.5\text{ mA}$	25°C		200	mV	
I_{CC}	Supply current	LMV331	25°C		40	100	μA
		LMV393 (both comparators)	25°C		70	140	
		LMV339 (all four comparators)	25°C		140	200	

LMV331, LMV393, LMV339

SLCS136T – AUGUST 1999 – REVISED JANUARY 2015

www.ti.com
7.6 Electrical Characteristics, $V_{CC+} = 5\text{ V}$
 $V_{CC+} = 5\text{ V}$, $GND = 0\text{ V}$, at specified free-air temperature (unless otherwise noted)

PARAMETER		TEST CONDITIONS	T_A	MIN	TYP	MAX	UNIT
V_{IO}	Input offset voltage		25°C		1.7	7	mV
			–40°C to 125°C			9	
α_{VIO}	Average temperature coefficient of input offset voltage		25°C		5		$\mu\text{V}/^\circ\text{C}$
I_{IB}	Input bias current		25°C		25	250	nA
			–40°C to 125°C			400	
I_{IO}	Input offset current		25°C		2	50	nA
			–40°C to 125°C			150	
I_O	Output current (sinking)	$V_O \leq 1.5\text{ V}$	25°C	10	84		mA
	Output Leakage Current		25°C		0.003		μA
			–40°C to 125°C			1	
V_{ICR}	Common-mode input voltage range		25°C	–0.1 to 4.2			V
A_{VD}	Large-signal differential voltage gain		25°C	20	50		V/mV
V_{SAT}	Saturation voltage	$I_O \leq 4\text{ mA}$	25°C		200	400	mV
			–40°C to 125°C			700	
I_{CC}	Supply current	LMV331	25°C		60	120	μA
			–40°C to 125°C			150	
		LMV393 (both comparators)	25°C		100	200	
			–40°C to 125°C			250	
		LMV339 (all four comparators)	25°C		170	300	
			–40°C to 125°C			350	

7.7 Switching Characteristics, $V_{CC+} = 2.7\text{ V}$
 $T_A = 25^\circ\text{C}$, $V_{CC+} = 2.7\text{ V}$, $R_L = 5.1\text{ k}\Omega$, $GND = 0\text{ V}$ (unless otherwise noted)

PARAMETER		TEST CONDITIONS	TYP	UNIT
t_{PHL}	Propagation delay high to low level output switching	Input overdrive = 10 mV	1000	ns
		Input overdrive = 100 mV	350	
t_{PLH}	Propagation delay low to high level output switching	Input overdrive = 10 mV	500	ns
		Input overdrive = 100 mV	400	

7.8 Switching Characteristics, $V_{CC+} = 5\text{ V}$
 $T_A = 25^\circ\text{C}$, $V_{CC+} = 5\text{ V}$, $R_L = 5.1\text{ k}\Omega$, $GND = 0\text{ V}$ (unless otherwise noted)

PARAMETER		TEST CONDITIONS	TYP	UNIT
t_{PHL}	Propagation delay high to low level output switching	Input overdrive = 10 mV	600	ns
		Input overdrive = 100 mV	200	
t_{PLH}	Propagation delay low to high level output switching	Input overdrive = 10 mV	450	ns
		Input overdrive = 100 mV	300	

7.9 Typical Characteristics

Unless otherwise specified, VS = +5V, single supply, TA = 25°C

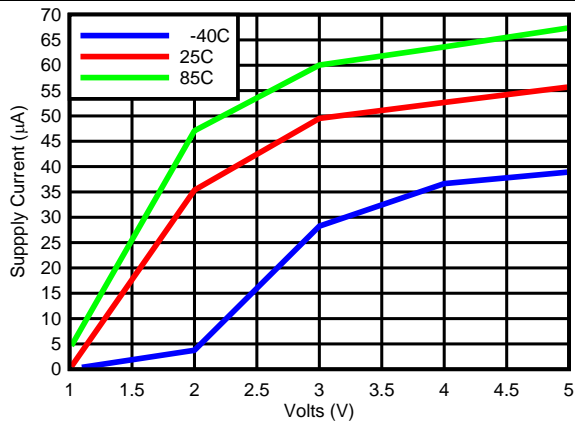

Figure 1. Supply Current vs Supply Voltage Output High (LMV33x)

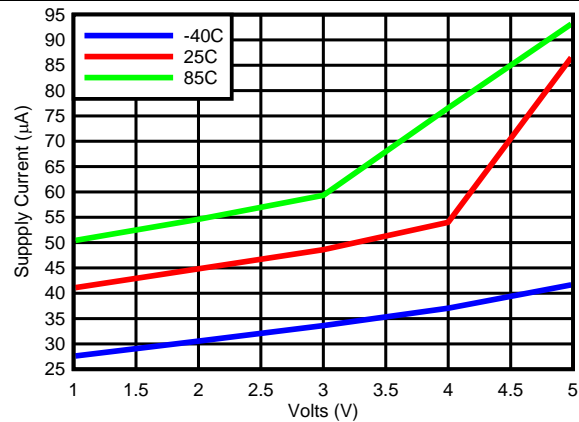

Figure 2. Supply Current vs Supply Voltage Output Low (LMV33x)

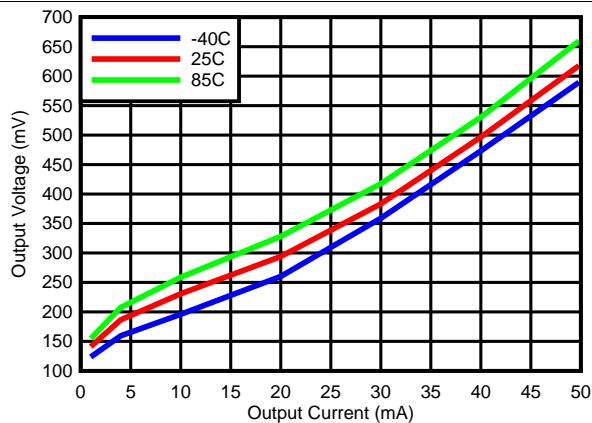

Figure 3. Output Voltage vs Output Current

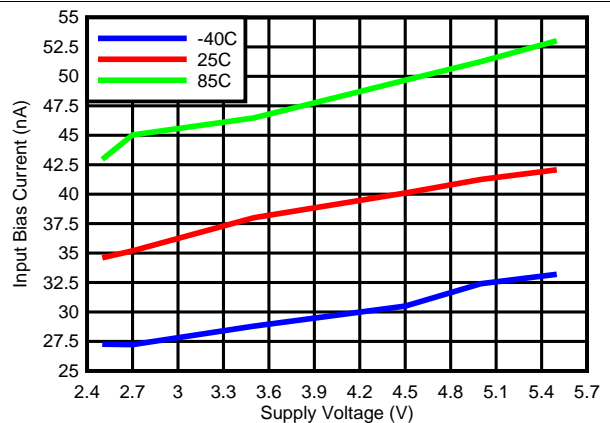

Figure 4. Input Bias Current vs Supply Voltage

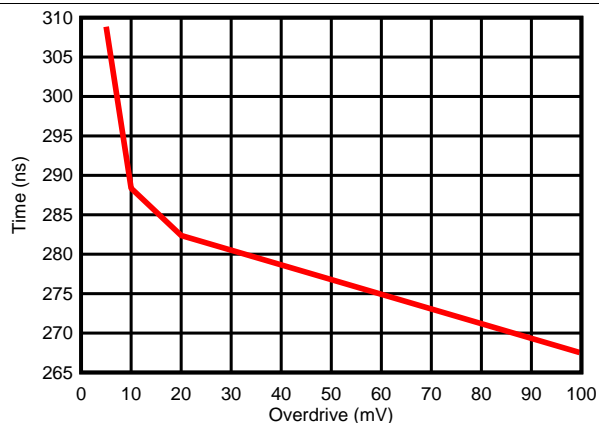

Figure 5. Response Time vs Input Overdrives Negative Transition (V_{CC}=5 V)

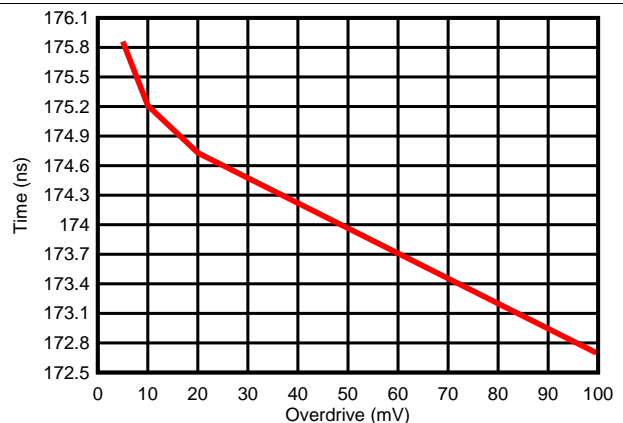

Figure 6. Response Time vs Input Overdrives Positive Transition (V_{CC} = 5 V)

Typical Characteristics (continued)

Unless otherwise specified, VS = +5V, single supply, TA = 25°C

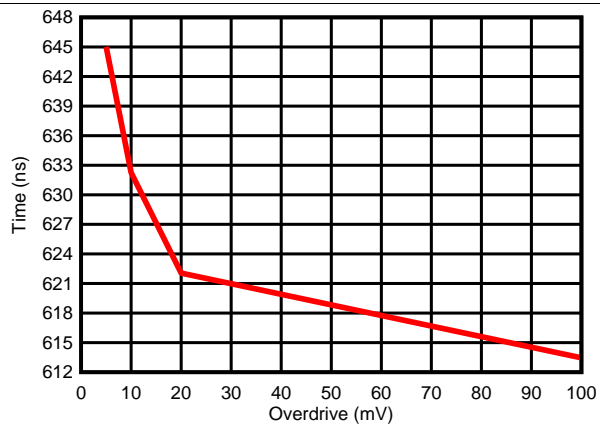

Figure 7. Response Time vs Input Overdrives Negative Transition (V_{CC} = 2.7 V)

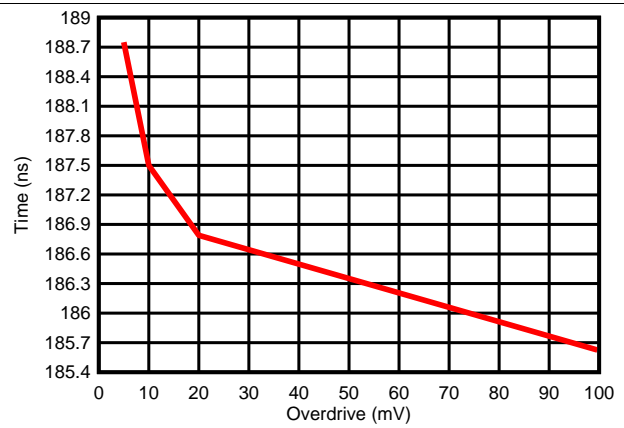

Figure 8. Response Time vs Input Overdrives Positive Transition (V_{CC} = 2.7 V)

8 Detailed Description

8.1 Overview

The LMV331, LMV393 and LMV339 family of comparators have the ability to operate up to 5 V on the supply pin. This standard device has proven ubiquity and versatility across a wide range of applications. This is due to its low I_q and fast response.

The open-drain output allows the user to configure the output's logic low voltage (V_{OL}) and can be utilized to enable the comparator to be used in AND functionality.

8.2 Functional Block Diagram

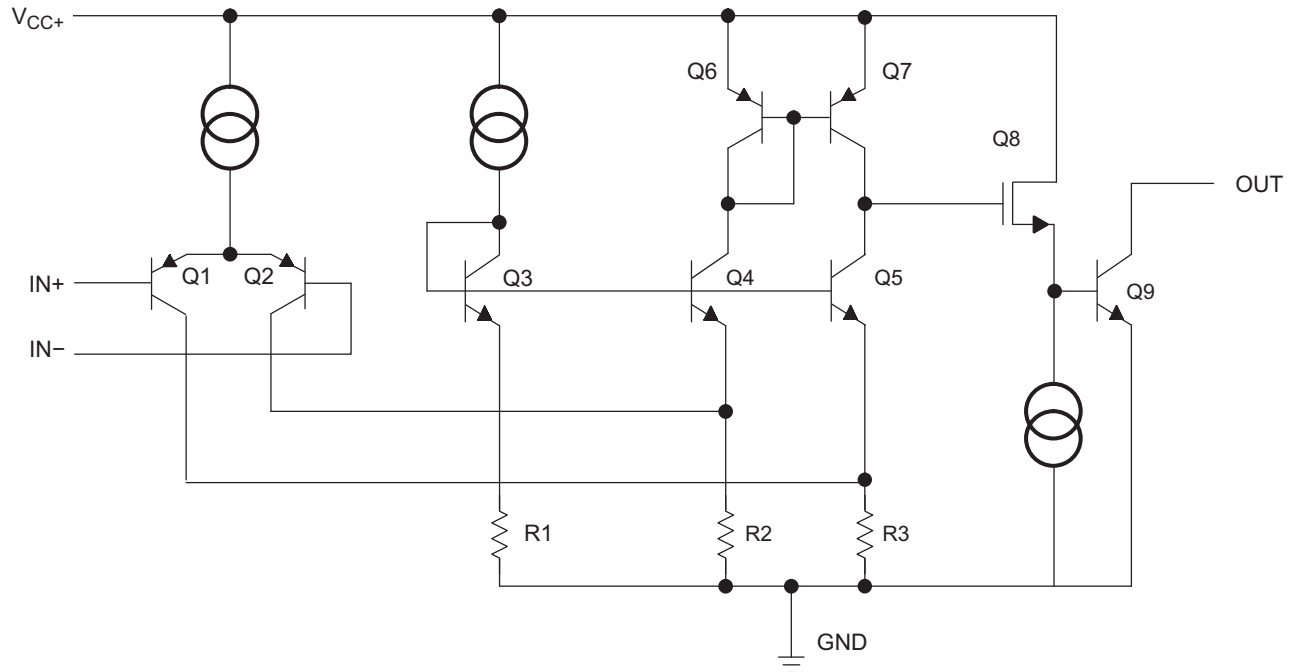

8.3 Feature Description

The LMV331, LMV393 and LMV339 consists of a PNP input, whose V_{be} creates a limit on the input common mode voltage capability, allowing LMV33x to accurately function from ground to $V_{CC}-V_{be}$ (~700mV) differential input. This enables much head room for modern day supplies of 3.3 V and 5.0 V.

The output consists of an open drain NPN (pull-down or low side) transistor. The output NPN will sink current when the positive input voltage is higher than the negative input voltage and the offset voltage. The V_{OL} is resistive and will scale with the output current. Please see [Figure 3](#) for V_{OL} values with respect to the output current.

8.4 Device Functional Modes

8.4.1 Voltage Comparison

The LMV33x operates solely as a voltage comparator, comparing the differential voltage between the positive and negative pins and outputs a logic low or high impedance (logic high with pull-up) based on the input differential polarity.

9 Application and Implementation

NOTE

Information in the following applications sections is not part of the TI component specification, and TI does not warrant its accuracy or completeness. TI's customers are responsible for determining suitability of components for their purposes. Customers should validate and test their design implementation to confirm system functionality.

9.1 Application Information

LMV331, LMV393, and LMV339 will typically be used to compare a single signal to a reference or two signals against each other. Many users take advantage of the open drain output to drive the comparison logic output to a logic voltage level to an MCU or logic device. The wide supply range and high voltage capability makes LMV331, LMV393, and LMV339 optimal for level shifting to a higher or lower voltage.

9.2 Typical Application

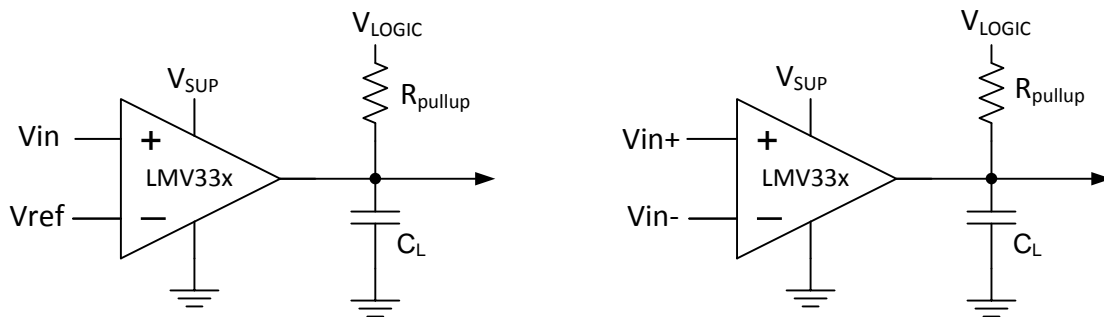

Figure 9. Typical Application Schematic

9.2.1 Design Requirements

For this design example, use the parameters listed in [Table 1](#) as the input parameters.

Table 1. Design Parameters

DESIGN PARAMETER	EXAMPLE VALUE
Input Voltage Range	0 V to 4.2 V
Supply Voltage	2.7 V to 5V
Logic Supply Voltage (R_{PULLUP} Voltage)	1 V to 5 V
Output Current (V_{LOGIC}/R_{PULLUP})	1 μ A to 20 mA
Input Overdrive Voltage	100 mV
Reference Voltage	2.5 V
Load Capacitance (C_L)	15 pF

9.2.2 Detailed Design Procedure

When using LMV331, LMV393, and LMV339 in a general comparator application, determine the following:

- Input Voltage Range
- Minimum Overdrive Voltage
- Output and Drive Current
- Response Time

9.2.2.1 Input Voltage Range

When choosing the input voltage range, the input common mode voltage range (V_{ICR}) must be taken in to account. If operating temperature is above or below 25°C the V_{ICR} can range from 0 V to $V_{CC} - 0.7$ V. This limits the input voltage range to as high as $V_{CC} - 0.7$ V and as low as 0 V. Operation outside of this range can yield incorrect comparisons.

Below is a possible list of input voltage situation and their outcomes:

1. When both IN- and IN+ are both within the common mode range:
 - (a) If IN- is higher than IN+ and the offset voltage, the output is low and the output transistor is sinking current
 - (b) If IN- is lower than IN+ and the offset voltage, the output is high impedance and the output transistor is not conducting
2. When IN- is higher than common mode and IN+ is within common mode, the output is low and the output transistor is sinking current
3. When IN+ is higher than common mode and IN- is within common mode, the output is high impedance and the output transistor is not conducting
4. When IN- and IN+ are both higher than common mode, the output is low and the output transistor is sinking current

9.2.2.2 Minimum Overdrive Voltage

Overdrive Voltage is the differential voltage produced between the positive and negative inputs of the comparator over the offset voltage (V_{IO}). In order to make an accurate comparison; the Overdrive Voltage (V_{OD}) should be higher than the input offset voltage (V_{IO}). Overdrive voltage can also determine the response time of the comparator, with the response time decreasing with increasing overdrive. [Figure 10](#) show positive and negative response times with respect to overdrive voltage.

9.2.2.3 Output and Drive Current

Output current is determined by the pull-up resistance (R_{pullup}) and V_{logic} voltage, refer to [Figure 9](#). The output current will produce a output low voltage (V_{OL}) from the comparator. In which V_{OL} is proportional to the output current. Use [Figure 3](#) to determine V_{OL} based on the output current.

The output current can also effect the transient response. More will be explained in the next section.

9.2.2.4 Response Time

The transient response can be determined by the load capacitance (C_L), load/pull-up resistance (R_{PULLUP}) and equivalent collector-emitter resistance (R_{CE}).

- The positive response time (τ_P) is approximately $\tau_P \sim R_{PULLUP} \times C_L$
- The negative response time (τ_N) is approximately $\tau_N \sim R_{CE} \times C_L$
 - R_{CE} can be determine by taking the slope of [Figure 3](#) in it's linear region at the desired temperature, or by dividing the V_{OL} by I_{out}

9.2.3 Application Curves

The following curves were generated with 5 V on V_{CC} and V_{Logic} , $R_{PULLUP} = 5.1$ k Ω , and 50 pF scope probe.

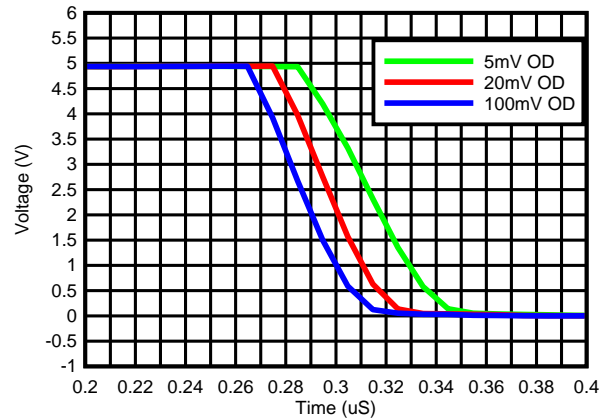

Figure 10. Response Time for Various Overdrives (Negative Transition)

10 Power Supply Recommendations

For fast response and comparison applications with noisy or AC inputs, it is recommended to use a bypass capacitor on the supply pin to reject any variation on the supply voltage. This variation cause temporary fluctuations in the comparator's input common mode range and create an inaccurate comparison.

11 Layout

11.1 Layout Guidelines

For accurate comparator applications without hysteresis it is important maintain a stable power supply with minimized noise and glitches, which can affect the high level input common mode voltage range. In order to achieve this, it is best to add a bypass capacitor between the supply voltage and ground. This should be implemented on the positive power supply and negative supply (if available). If a negative supply is not being used, do not put a capacitor between the IC's GND pin and system ground.

11.2 Layout Example

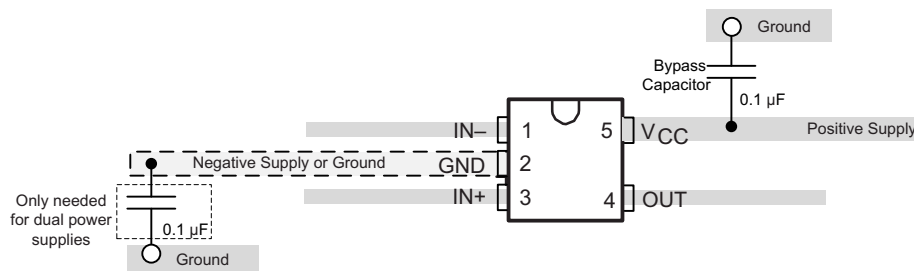

Figure 11. LMV331 Layout Example

12 Device and Documentation Support

12.1 Related Links

The table below lists quick access links. Categories include technical documents, support and community resources, tools and software, and quick access to sample or buy.

Table 2. Related Links

PARTS	PRODUCT FOLDER	SAMPLE & BUY	TECHNICAL DOCUMENTS	TOOLS & SOFTWARE	SUPPORT & COMMUNITY
LMV331	Click here	Click here	Click here	Click here	Click here
LMV393	Click here	Click here	Click here	Click here	Click here
LMV339	Click here	Click here	Click here	Click here	Click here

12.2 Trademarks

All trademarks are the property of their respective owners.

12.3 Electrostatic Discharge Caution



These devices have limited built-in ESD protection. The leads should be shorted together or the device placed in conductive foam during storage or handling to prevent electrostatic damage to the MOS gates.

12.4 Glossary

[SLYZ022](#) — *TI Glossary*.

This glossary lists and explains terms, acronyms, and definitions.

13 Mechanical, Packaging, and Orderable Information

The following pages include mechanical, packaging, and orderable information. This information is the most current data available for the designated devices. This data is subject to change without notice and revision of this document. For browser-based versions of this data sheet, refer to the left-hand navigation.

PACKAGING INFORMATION

Orderable Device	Status (1)	Package Type	Package Drawing	Pins	Package Qty	Eco Plan (2)	Lead/Ball Finish (6)	MSL Peak Temp (3)	Op Temp (°C)	Device Marking (4/5)	Samples
LMV331IDBVR	ACTIVE	SOT-23	DBV	5	3000	Green (RoHS & no Sb/Br)	CU NIPDAU	Level-1-260C-UNLIM	-40 to 125	(R1IC, R1II)	Samples
LMV331IDBVRE4	ACTIVE	SOT-23	DBV	5	3000	Green (RoHS & no Sb/Br)	CU NIPDAU	Level-1-260C-UNLIM	-40 to 125	(R1IC, R1II)	Samples
LMV331IDBVRG4	ACTIVE	SOT-23	DBV	5	3000	Green (RoHS & no Sb/Br)	CU NIPDAU	Level-1-260C-UNLIM	-40 to 125	(R1IC, R1II)	Samples
LMV331IDBVT	ACTIVE	SOT-23	DBV	5	250	Green (RoHS & no Sb/Br)	CU NIPDAU	Level-1-260C-UNLIM	-40 to 125	(R1IC, R1II)	Samples
LMV331IDBVTG4	ACTIVE	SOT-23	DBV	5	250	Green (RoHS & no Sb/Br)	CU NIPDAU	Level-1-260C-UNLIM	-40 to 125	(R1IC, R1II)	Samples
LMV331IDCKR	ACTIVE	SC70	DCK	5	3000	Green (RoHS & no Sb/Br)	CU NIPDAU CU NIPDAUAG	Level-1-260C-UNLIM	-40 to 125	(R2I, R2K, R2R)	Samples
LMV331IDCKRE4	ACTIVE	SC70	DCK	5	3000	Green (RoHS & no Sb/Br)	CU NIPDAU	Level-1-260C-UNLIM	-40 to 125	(R2I, R2K, R2R)	Samples
LMV331IDCKRG4	ACTIVE	SC70	DCK	5	3000	Green (RoHS & no Sb/Br)	CU NIPDAU	Level-1-260C-UNLIM	-40 to 125	(R2I, R2K, R2R)	Samples
LMV331IDCKT	ACTIVE	SC70	DCK	5	250	Green (RoHS & no Sb/Br)	CU NIPDAU CU NIPDAUAG	Level-1-260C-UNLIM	-40 to 125	(R2C, R2I, R2R)	Samples
LMV331IDCKTE4	ACTIVE	SC70	DCK	5	250	Green (RoHS & no Sb/Br)	CU NIPDAU	Level-1-260C-UNLIM	-40 to 125	(R2C, R2I, R2R)	Samples
LMV331IDCKTG4	ACTIVE	SC70	DCK	5	250	Green (RoHS & no Sb/Br)	CU NIPDAU	Level-1-260C-UNLIM	-40 to 125	(R2C, R2I, R2R)	Samples
LMV339ID	ACTIVE	SOIC	D	14	50	Green (RoHS & no Sb/Br)	CU NIPDAU	Level-1-260C-UNLIM	-40 to 125	LMV339I	Samples
LMV339IDR	ACTIVE	SOIC	D	14	2500	Green (RoHS & no Sb/Br)	CU NIPDAU	Level-1-260C-UNLIM	-40 to 125	LMV339I	Samples
LMV339IPW	ACTIVE	TSSOP	PW	14	90	Green (RoHS & no Sb/Br)	CU NIPDAU	Level-1-260C-UNLIM	-40 to 125	MV339I	Samples
LMV339IPWR	ACTIVE	TSSOP	PW	14	2000	Green (RoHS & no Sb/Br)	CU NIPDAU	Level-1-260C-UNLIM	-40 to 125	MV339I	Samples
LMV339IPWRE4	ACTIVE	TSSOP	PW	14	2000	Green (RoHS & no Sb/Br)	CU NIPDAU	Level-1-260C-UNLIM	-40 to 125	MV339I	Samples
LMV339IPWRG4	ACTIVE	TSSOP	PW	14	2000	Green (RoHS & no Sb/Br)	CU NIPDAU	Level-1-260C-UNLIM	-40 to 125	MV339I	Samples

Orderable Device	Status (1)	Package Type	Package Drawing	Pins	Package Qty	Eco Plan (2)	Lead/Ball Finish (6)	MSL Peak Temp (3)	Op Temp (°C)	Device Marking (4/5)	Samples
LMV339IRUCR	ACTIVE	QFN	RUC	14	3000	Green (RoHS & no Sb/Br)	CU NIPDAUAG	Level-1-260C-UNLIM	-40 to 125	(RT, RTR)	Samples
LMV393ID	ACTIVE	SOIC	D	8	75	Green (RoHS & no Sb/Br)	CU NIPDAU	Level-1-260C-UNLIM	-40 to 125	MV393I	Samples
LMV393IDDUR	ACTIVE	VSSOP	DDU	8	3000	Green (RoHS & no Sb/Br)	CU NIPDAU	Level-1-260C-UNLIM	-40 to 125	RABR	Samples
LMV393IDDURG4	ACTIVE	VSSOP	DDU	8	3000	Green (RoHS & no Sb/Br)	CU NIPDAU	Level-1-260C-UNLIM	-40 to 125	RABR	Samples
LMV393IDGKR	ACTIVE	VSSOP	DGK	8	2500	Green (RoHS & no Sb/Br)	CU NIPDAU CU NIPDAUAG	Level-1-260C-UNLIM	-40 to 125	(R9B, R9Q, R9R)	Samples
LMV393IDGKRG4	ACTIVE	VSSOP	DGK	8	2500	Green (RoHS & no Sb/Br)	CU NIPDAUAG	Level-1-260C-UNLIM	-40 to 125	(R9B, R9Q, R9R)	Samples
LMV393IDR	ACTIVE	SOIC	D	8	2500	Green (RoHS & no Sb/Br)	CU NIPDAU CU SN	Level-1-260C-UNLIM	-40 to 125	MV393I	Samples
LMV393IDRG4	ACTIVE	SOIC	D	8	2500	Green (RoHS & no Sb/Br)	CU NIPDAU	Level-1-260C-UNLIM	-40 to 125	MV393I	Samples
LMV393IPW	ACTIVE	TSSOP	PW	8	150	Green (RoHS & no Sb/Br)	CU NIPDAU	Level-1-260C-UNLIM	-40 to 125	MV393I	Samples
LMV393IPWG4	ACTIVE	TSSOP	PW	8	150	Green (RoHS & no Sb/Br)	CU NIPDAU	Level-1-260C-UNLIM	-40 to 125	MV393I	Samples
LMV393IPWR	ACTIVE	TSSOP	PW	8	2000	Green (RoHS & no Sb/Br)	CU NIPDAU	Level-1-260C-UNLIM	-40 to 125	MV393I	Samples
LMV393IPWRG4	ACTIVE	TSSOP	PW	8	2000	Green (RoHS & no Sb/Br)	CU NIPDAU	Level-1-260C-UNLIM	-40 to 125	MV393I	Samples

(1) The marketing status values are defined as follows:

ACTIVE: Product device recommended for new designs.

LIFEBUY: TI has announced that the device will be discontinued, and a lifetime-buy period is in effect.

NRND: Not recommended for new designs. Device is in production to support existing customers, but TI does not recommend using this part in a new design.

PREVIEW: Device has been announced but is not in production. Samples may or may not be available.

OBSOLETE: TI has discontinued the production of the device.

(2) **RoHS:** TI defines "RoHS" to mean semiconductor products that are compliant with the current EU RoHS requirements for all 10 RoHS substances, including the requirement that RoHS substance do not exceed 0.1% by weight in homogeneous materials. Where designed to be soldered at high temperatures, "RoHS" products are suitable for use in specified lead-free processes. TI may reference these types of products as "Pb-Free".

RoHS Exempt: TI defines "RoHS Exempt" to mean products that contain lead but are compliant with EU RoHS pursuant to a specific EU RoHS exemption.

Green: TI defines "Green" to mean the content of Chlorine (Cl) and Bromine (Br) based flame retardants meet JS709B low halogen requirements of <=1000ppm threshold. Antimony trioxide based flame retardants must also meet the <=1000ppm threshold requirement.

- (3) MSL, Peak Temp. - The Moisture Sensitivity Level rating according to the JEDEC industry standard classifications, and peak solder temperature.
- (4) There may be additional marking, which relates to the logo, the lot trace code information, or the environmental category on the device.
- (5) Multiple Device Markings will be inside parentheses. Only one Device Marking contained in parentheses and separated by a "~" will appear on a device. If a line is indented then it is a continuation of the previous line and the two combined represent the entire Device Marking for that device.
- (6) Lead/Ball Finish - Orderable Devices may have multiple material finish options. Finish options are separated by a vertical ruled line. Lead/Ball Finish values may wrap to two lines if the finish value exceeds the maximum column width.

Important Information and Disclaimer:The information provided on this page represents TI's knowledge and belief as of the date that it is provided. TI bases its knowledge and belief on information provided by third parties, and makes no representation or warranty as to the accuracy of such information. Efforts are underway to better integrate information from third parties. TI has taken and continues to take reasonable steps to provide representative and accurate information but may not have conducted destructive testing or chemical analysis on incoming materials and chemicals. TI and TI suppliers consider certain information to be proprietary, and thus CAS numbers and other limited information may not be available for release.

In no event shall TI's liability arising out of such information exceed the total purchase price of the TI part(s) at issue in this document sold by TI to Customer on an annual basis.

OTHER QUALIFIED VERSIONS OF LMV331, LMV393 :

- Automotive: [LMV331-Q1](#), [LMV393-Q1](#)

NOTE: Qualified Version Definitions:

- Automotive - Q100 devices qualified for high-reliability automotive applications targeting zero defects

TAPE AND REEL INFORMATION

QUADRANT ASSIGNMENTS FOR PIN 1 ORIENTATION IN TAPE

*All dimensions are nominal

Device	Package Type	Package Drawing	Pins	SPQ	Reel Diameter (mm)	Reel Width W1 (mm)	A0 (mm)	B0 (mm)	K0 (mm)	P1 (mm)	W (mm)	Pin1 Quadrant
LMV331IDBVR	SOT-23	DBV	5	3000	178.0	9.0	3.23	3.17	1.37	4.0	8.0	Q3
LMV331IDBVT	SOT-23	DBV	5	250	178.0	9.0	3.23	3.17	1.37	4.0	8.0	Q3
LMV331IDCKR	SC70	DCK	5	3000	180.0	9.2	2.3	2.55	1.2	4.0	8.0	Q3
LMV331IDCKR	SC70	DCK	5	3000	178.0	9.0	2.4	2.5	1.2	4.0	8.0	Q3
LMV331IDCKT	SC70	DCK	5	250	180.0	9.2	2.3	2.55	1.2	4.0	8.0	Q3
LMV331IDCKT	SC70	DCK	5	250	178.0	9.0	2.4	2.5	1.2	4.0	8.0	Q3
LMV339IDR	SOIC	D	14	2500	330.0	16.4	6.5	9.0	2.1	8.0	16.0	Q1
LMV339IPWR	TSSOP	PW	14	2000	330.0	12.4	6.9	5.6	1.6	8.0	12.0	Q1
LMV339IRUCR	QFN	RUC	14	3000	180.0	8.4	2.3	2.3	0.55	4.0	8.0	Q2
LMV393IDDUR	VSSOP	DDU	8	3000	180.0	8.4	2.25	3.35	1.05	4.0	8.0	Q3
LMV393IDGKR	VSSOP	DGK	8	2500	330.0	12.4	5.3	3.4	1.4	8.0	12.0	Q1
LMV393IDR	SOIC	D	8	2500	330.0	12.4	6.4	5.2	2.1	8.0	12.0	Q1
LMV393IDR	SOIC	D	8	2500	330.0	12.8	6.4	5.2	2.1	8.0	12.0	Q1
LMV393IDRG4	SOIC	D	8	2500	330.0	12.4	6.4	5.2	2.1	8.0	12.0	Q1
LMV393IPWR	TSSOP	PW	8	2000	330.0	12.4	7.0	3.6	1.6	8.0	12.0	Q1

TAPE AND REEL BOX DIMENSIONS

*All dimensions are nominal

Device	Package Type	Package Drawing	Pins	SPQ	Length (mm)	Width (mm)	Height (mm)
LMV331IDBVR	SOT-23	DBV	5	3000	180.0	180.0	18.0
LMV331IDBVT	SOT-23	DBV	5	250	180.0	180.0	18.0
LMV331IDCKR	SC70	DCK	5	3000	205.0	200.0	33.0
LMV331IDCKR	SC70	DCK	5	3000	180.0	180.0	18.0
LMV331IDCKT	SC70	DCK	5	250	205.0	200.0	33.0
LMV331IDCKT	SC70	DCK	5	250	180.0	180.0	18.0
LMV339IDR	SOIC	D	14	2500	367.0	367.0	38.0
LMV339IPWR	TSSOP	PW	14	2000	367.0	367.0	35.0
LMV339IRUCR	QFN	RUC	14	3000	202.0	201.0	28.0
LMV393IDDUR	VSSOP	DDU	8	3000	202.0	201.0	28.0
LMV393IDGKR	VSSOP	DGK	8	2500	364.0	364.0	27.0
LMV393IDR	SOIC	D	8	2500	340.5	338.1	20.6
LMV393IDR	SOIC	D	8	2500	364.0	364.0	27.0
LMV393IDRG4	SOIC	D	8	2500	340.5	338.1	20.6
LMV393IPWR	TSSOP	PW	8	2000	367.0	367.0	35.0

RUC (S-PX2QFN-N14)

PLASTIC QUAD FLATPACK NO-LEAD

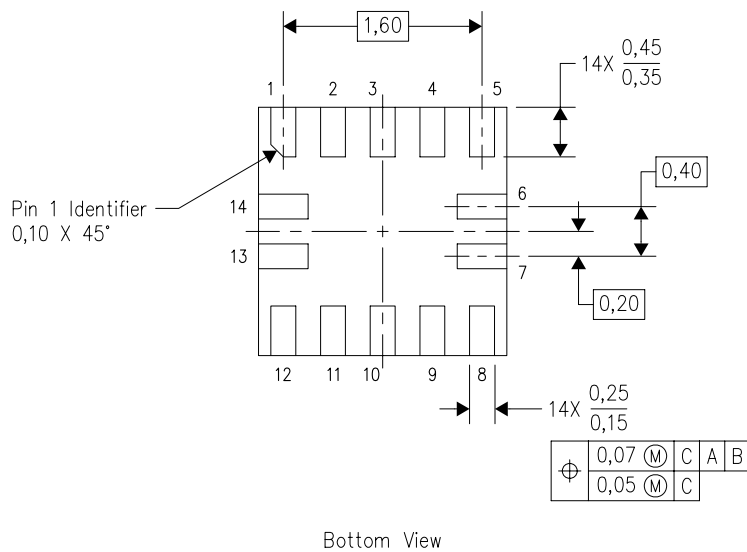
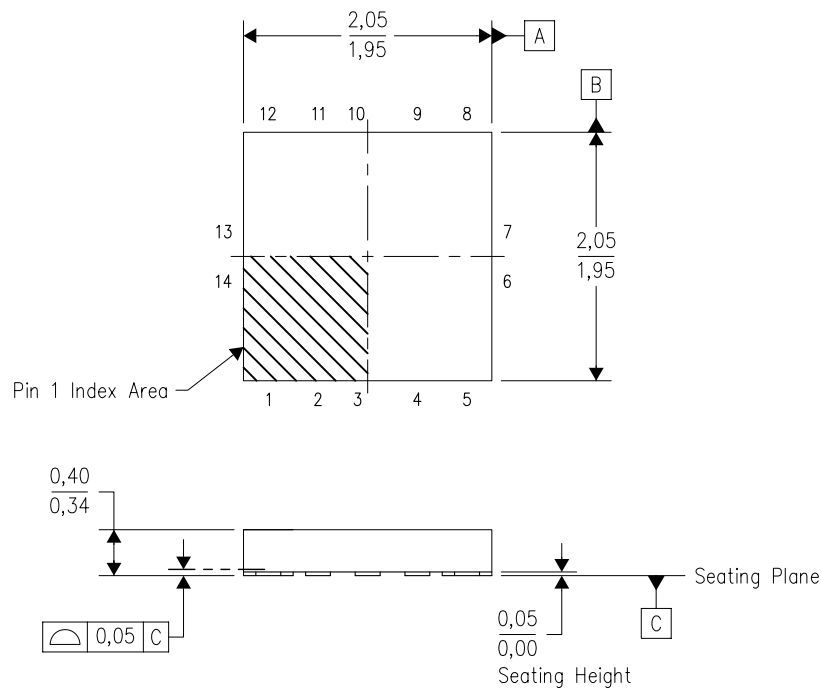

Bottom View

4208447/C 08/2008

- NOTES:
- A. All linear dimensions are in millimeters. Dimensioning and tolerancing per ASME Y14.5M-1994.
 - B. This drawing is subject to change without notice.
 - C. QFN (Quad Flatpack No-lead) package configuration.
 - D. This package complies to JEDEC MO-288 variation X2GFE.

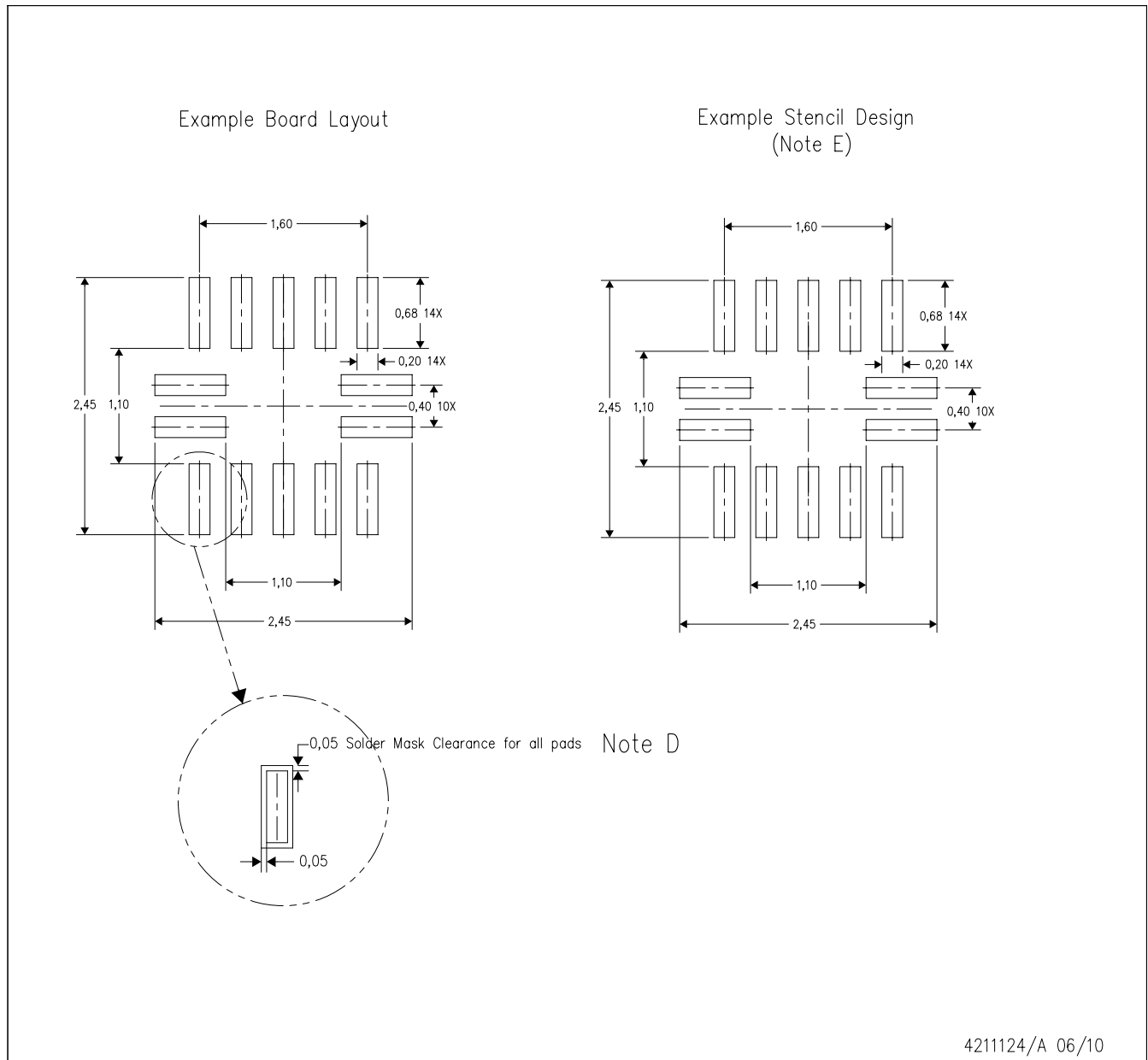

- NOTES:
- A. All linear dimensions are in millimeters.
 - B. This drawing is subject to change without notice.
 - C. Publication IPC-7351 is recommended for alternate designs.
 - D. Customers should contact their board fabrication site for minimum solder mask web tolerances between signal pads.
 - E. Maximum stencil thickness 0,127 mm (5 mils). All linear dimensions are in millimeters.
 - F. Laser cutting apertures with trapezoidal walls and also rounding corners will offer better paste release. Customers should contact their board assembly site for stencil design recommendations. Refer to IPC 7525 for stencil design considerations.
 - G. Side aperture dimensions over-print land for acceptable area ratio > 0.66. Customer may reduce side aperture dimensions if stencil manufacturing process allows for sufficient release at smaller opening.

D (R-PDSO-G14)

PLASTIC SMALL OUTLINE



- NOTES:
- A. All linear dimensions are in inches (millimeters).
 - B. This drawing is subject to change without notice.
 -  Body length does not include mold flash, protrusions, or gate burrs. Mold flash, protrusions, or gate burrs shall not exceed 0.006 (0,15) each side.
 -  Body width does not include interlead flash. Interlead flash shall not exceed 0.017 (0,43) each side.
 - E. Reference JEDEC MS-012 variation AB.

D (R-PDSO-G14)

PLASTIC SMALL OUTLINE



4211283-3/E 08/12



- NOTES:
- All linear dimensions are in millimeters.
 - This drawing is subject to change without notice.
 - Publication IPC-7351 is recommended for alternate designs.
 - Laser cutting apertures with trapezoidal walls and also rounding corners will offer better paste release. Customers should contact their board assembly site for stencil design recommendations. Refer to IPC-7525 for other stencil recommendations.
 - Customers should contact their board fabrication site for solder mask tolerances between and around signal pads.

PW (R-PDSO-G14)

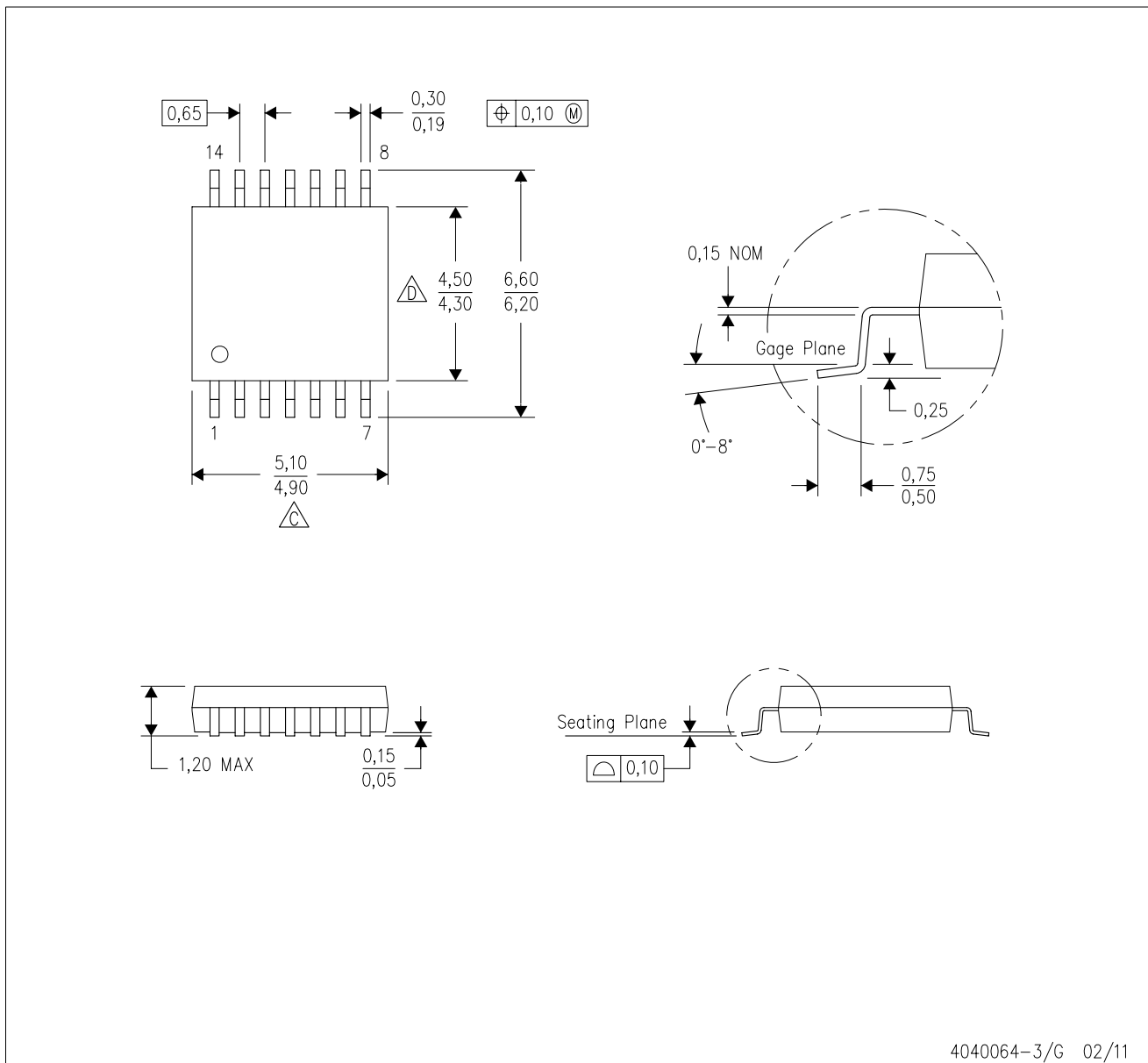
PLASTIC SMALL OUTLINE



4040064-3/G 02/11

- NOTES:
- A. All linear dimensions are in millimeters. Dimensioning and tolerancing per ASME Y14.5M-1994.
 - B. This drawing is subject to change without notice.
 -  C. Body length does not include mold flash, protrusions, or gate burrs. Mold flash, protrusions, or gate burrs shall not exceed 0,15 each side.
 -  D. Body width does not include interlead flash. Interlead flash shall not exceed 0,25 each side.
 - E. Falls within JEDEC MO-153

PW (R-PDSO-G14)

PLASTIC SMALL OUTLINE



- NOTES:
- All linear dimensions are in millimeters.
 - This drawing is subject to change without notice.
 - Publication IPC-7351 is recommended for alternate designs.
 - Laser cutting apertures with trapezoidal walls and also rounding corners will offer better paste release. Customers should contact their board assembly site for stencil design recommendations. Refer to IPC-7525 for other stencil recommendations.
 - Customers should contact their board fabrication site for solder mask tolerances between and around signal pads.



D0008A

PACKAGE OUTLINE

SOIC - 1.75 mm max height

SMALL OUTLINE INTEGRATED CIRCUIT



4214825/C 02/2019

NOTES:

- Linear dimensions are in inches [millimeters]. Dimensions in parenthesis are for reference only. Controlling dimensions are in inches. Dimensioning and tolerancing per ASME Y14.5M.
- This drawing is subject to change without notice.
- This dimension does not include mold flash, protrusions, or gate burrs. Mold flash, protrusions, or gate burrs shall not exceed $.006$ [0.15] per side.
- This dimension does not include interlead flash.
- Reference JEDEC registration MS-012, variation AA.

EXAMPLE BOARD LAYOUT

D0008A

SOIC - 1.75 mm max height

SMALL OUTLINE INTEGRATED CIRCUIT



LAND PATTERN EXAMPLE
EXPOSED METAL SHOWN
SCALE:8X



SOLDER MASK DETAILS

4214825/C 02/2019

NOTES: (continued)

- 6. Publication IPC-7351 may have alternate designs.
- 7. Solder mask tolerances between and around signal pads can vary based on board fabrication site.

EXAMPLE STENCIL DESIGN

D0008A

SOIC - 1.75 mm max height

SMALL OUTLINE INTEGRATED CIRCUIT



SOLDER PASTE EXAMPLE
BASED ON .005 INCH [0.125 MM] THICK STENCIL
SCALE:8X

4214825/C 02/2019

NOTES: (continued)

8. Laser cutting apertures with trapezoidal walls and rounded corners may offer better paste release. IPC-7525 may have alternate design recommendations.
9. Board assembly site may have different recommendations for stencil design.

EXAMPLE BOARD LAYOUT

DBV0005A

SOT-23 - 1.45 mm max height

SMALL OUTLINE TRANSISTOR



LAND PATTERN EXAMPLE
EXPOSED METAL SHOWN
SCALE:15X



SOLDER MASK DETAILS

4214839/D 11/2018

NOTES: (continued)

- 5. Publication IPC-7351 may have alternate designs.
- 6. Solder mask tolerances between and around signal pads can vary based on board fabrication site.

EXAMPLE STENCIL DESIGN

DBV0005A

SOT-23 - 1.45 mm max height

SMALL OUTLINE TRANSISTOR



SOLDER PASTE EXAMPLE
BASED ON 0.125 mm THICK STENCIL
SCALE:15X

4214839/D 11/2018

NOTES: (continued)

7. Laser cutting apertures with trapezoidal walls and rounded corners may offer better paste release. IPC-7525 may have alternate design recommendations.
8. Board assembly site may have different recommendations for stencil design.



- NOTES:
- A. All linear dimensions are in millimeters.
 - B. This drawing is subject to change without notice.
 - C. Publication IPC-7351 is recommended for alternate designs.
 - D. Laser cutting apertures with trapezoidal walls and also rounding corners will offer better paste release. Customers should contact their board assembly site for stencil design recommendations. Refer to IPC-7525 for other stencil recommendations.
 - E. Customers should contact their board fabrication site for solder mask tolerances between and around signal pads.

PW0008A



PACKAGE OUTLINE
TSSOP - 1.2 mm max height

SMALL OUTLINE PACKAGE



4221848/A 02/2015

NOTES:

- All linear dimensions are in millimeters. Any dimensions in parenthesis are for reference only. Dimensioning and tolerancing per ASME Y14.5M.
- This drawing is subject to change without notice.
- This dimension does not include mold flash, protrusions, or gate burrs. Mold flash, protrusions, or gate burrs shall not exceed 0.15 mm per side.
- This dimension does not include interlead flash. Interlead flash shall not exceed 0.25 mm per side.
- Reference JEDEC registration MO-153, variation AA.

EXAMPLE BOARD LAYOUT

PW0008A

TSSOP - 1.2 mm max height

SMALL OUTLINE PACKAGE

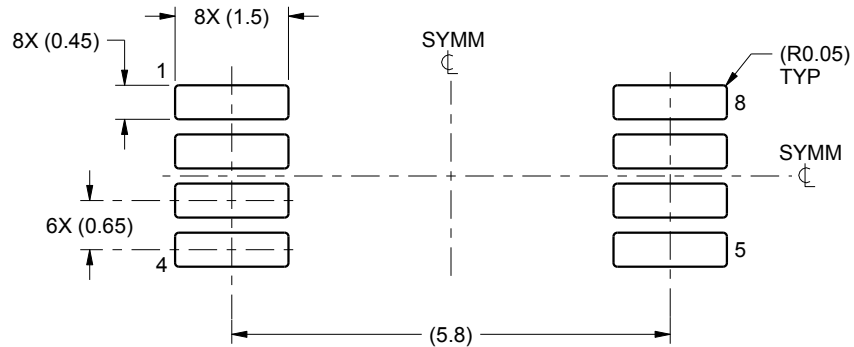

LAND PATTERN EXAMPLE
SCALE:10X

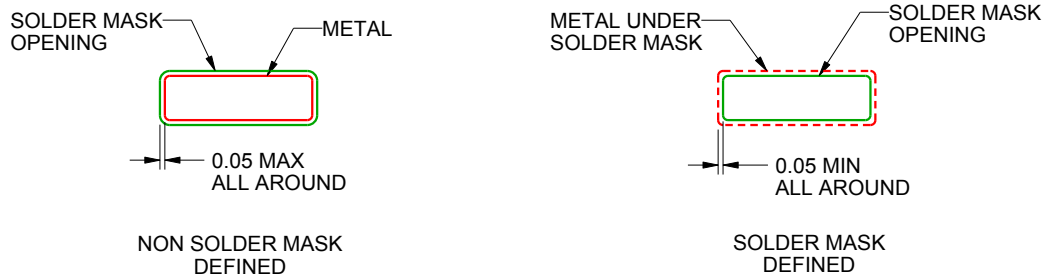

SOLDER MASK DETAILS
NOT TO SCALE

4221848/A 02/2015

NOTES: (continued)

- 6. Publication IPC-7351 may have alternate designs.
- 7. Solder mask tolerances between and around signal pads can vary based on board fabrication site.

EXAMPLE STENCIL DESIGN

PW0008A

TSSOP - 1.2 mm max height

SMALL OUTLINE PACKAGE



SOLDER PASTE EXAMPLE
BASED ON 0.125 mm THICK STENCIL
SCALE:10X

4221848/A 02/2015

NOTES: (continued)

8. Laser cutting apertures with trapezoidal walls and rounded corners may offer better paste release. IPC-7525 may have alternate design recommendations.
9. Board assembly site may have different recommendations for stencil design.

DCK (R-PDSO-G5)

PLASTIC SMALL-OUTLINE PACKAGE

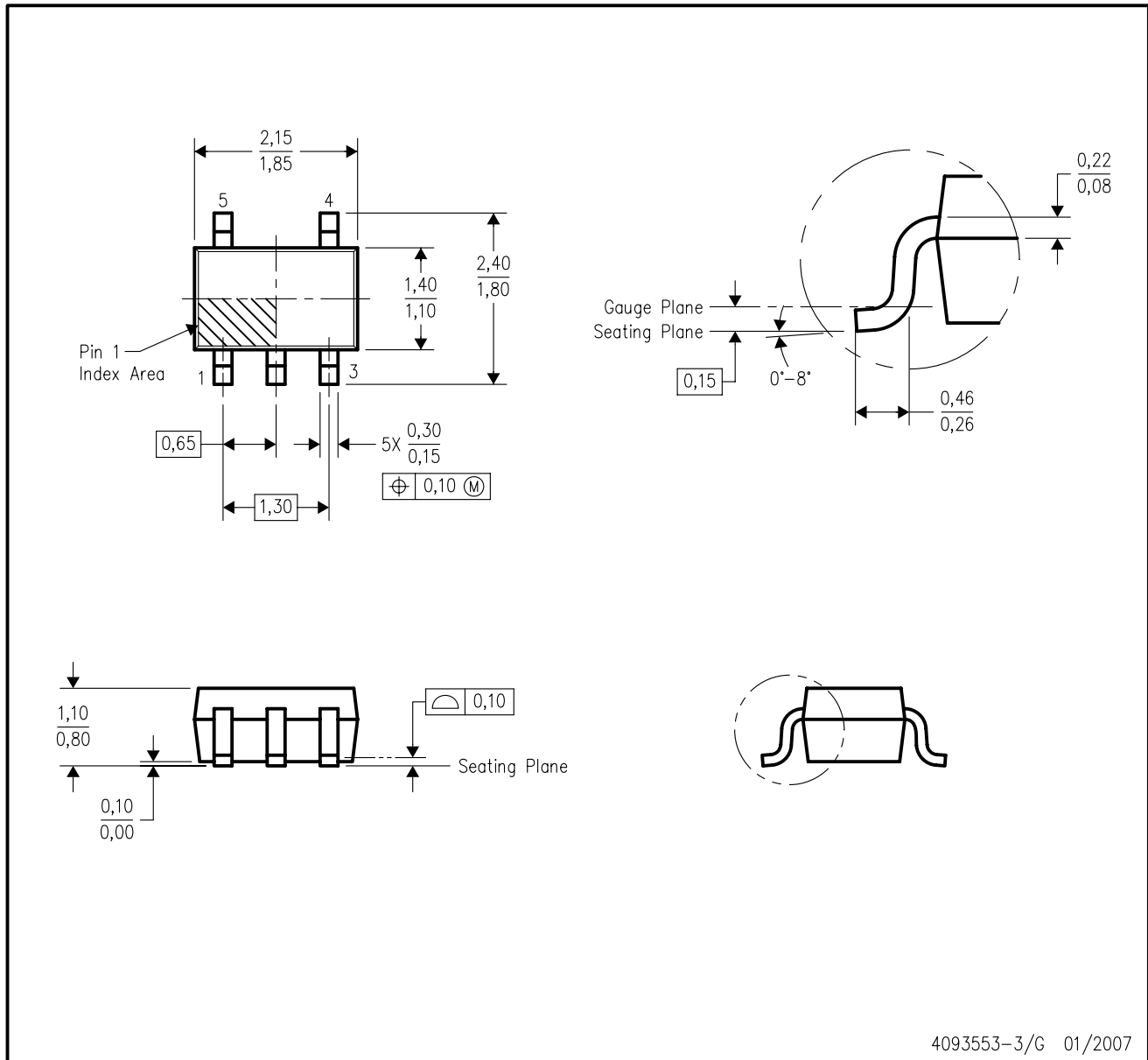

- NOTES:
- A. All linear dimensions are in millimeters.
 - B. This drawing is subject to change without notice.
 - C. Body dimensions do not include mold flash or protrusion. Mold flash and protrusion shall not exceed 0.15 per side.
 - D. Falls within JEDEC MO-203 variation AA.

DCK (R-PDSO-G5)

PLASTIC SMALL OUTLINE

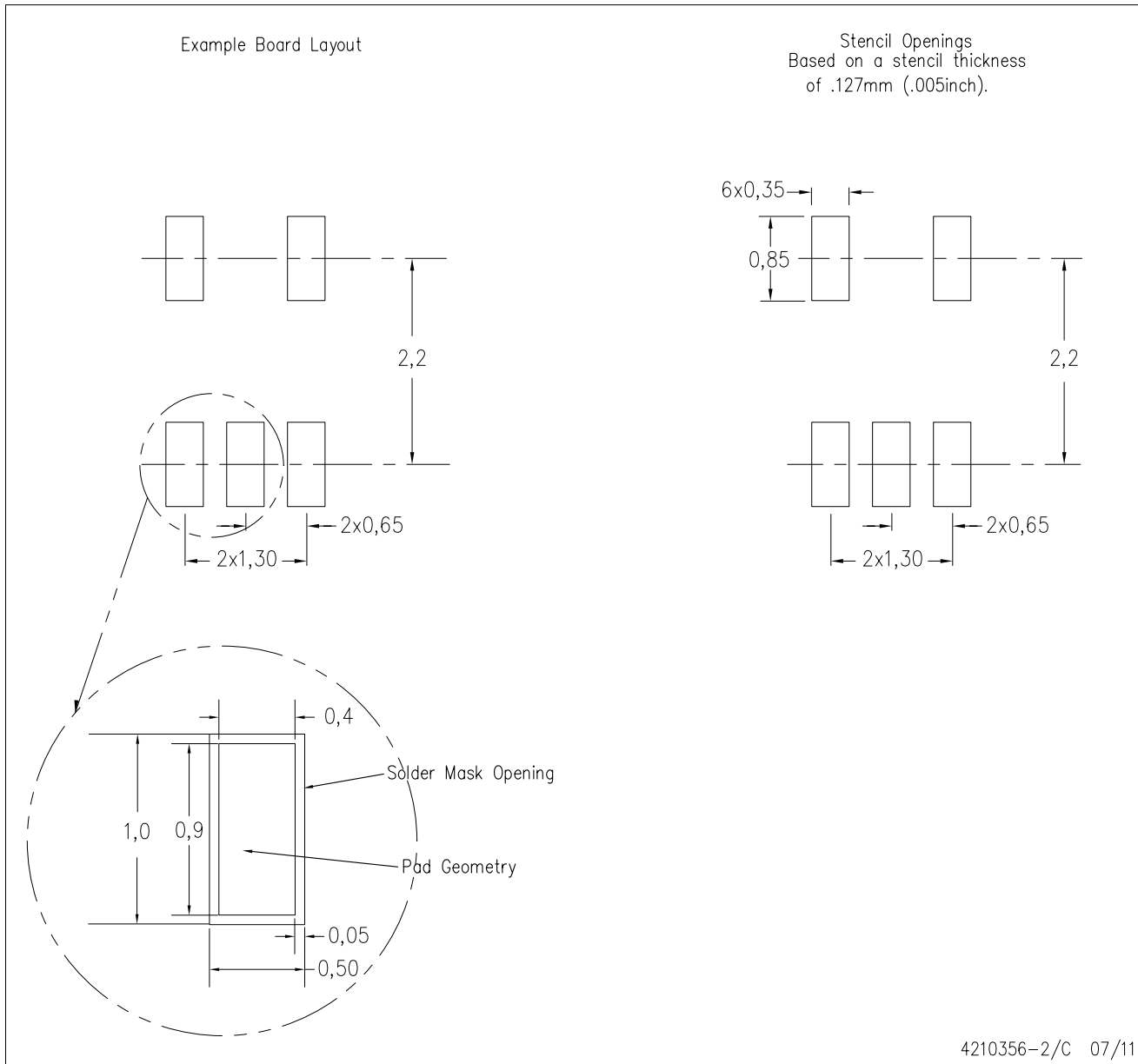

- NOTES:
- All linear dimensions are in millimeters.
 - This drawing is subject to change without notice.
 - Customers should place a note on the circuit board fabrication drawing not to alter the center solder mask defined pad.
 - Publication IPC-7351 is recommended for alternate designs.
 - Laser cutting apertures with trapezoidal walls and also rounding corners will offer better paste release. Customers should contact their board assembly site for stencil design recommendations. Example stencil design based on a 50% volumetric metal load solder paste. Refer to IPC-7525 for other stencil recommendations.

DDU (S-PDSO-G8)

PLASTIC SMALL OUTLINE PACKAGE (DIE UP)

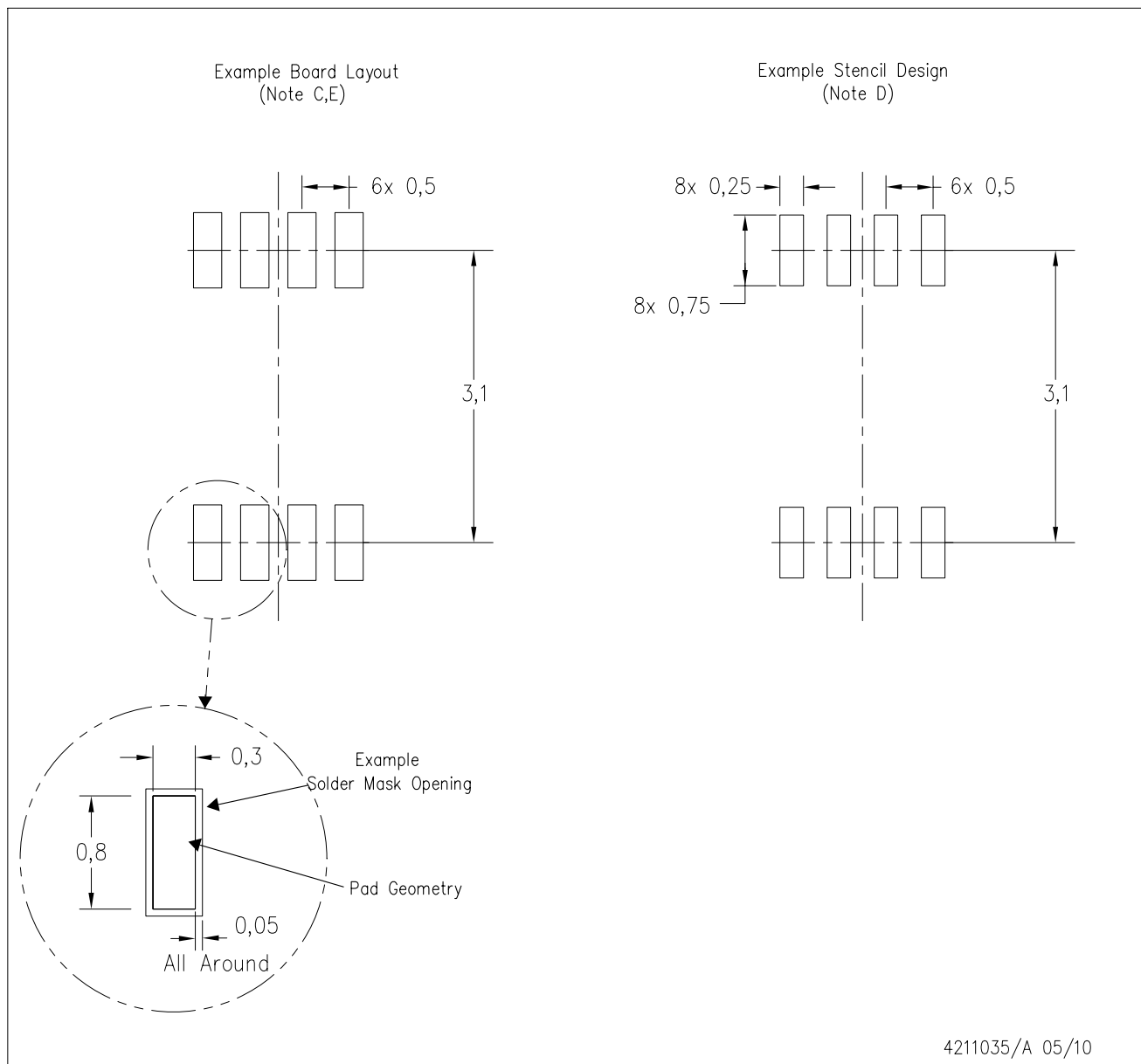

- NOTES:
- All linear dimensions are in millimeters.
 - This drawing is subject to change without notice.
 - Publication IPC-7351 is recommended for alternate designs.
 - Laser cutting apertures with trapezoidal walls and also rounding corners will offer better paste release. Customers should contact their board assembly site for stencil design recommendations. Refer to IPC-7525.
 - Customers should contact their board fabrication site for solder mask tolerances between and around signal pads.

IMPORTANT NOTICE AND DISCLAIMER

TI PROVIDES TECHNICAL AND RELIABILITY DATA (INCLUDING DATASHEETS), DESIGN RESOURCES (INCLUDING REFERENCE DESIGNS), APPLICATION OR OTHER DESIGN ADVICE, WEB TOOLS, SAFETY INFORMATION, AND OTHER RESOURCES "AS IS" AND WITH ALL FAULTS, AND DISCLAIMS ALL WARRANTIES, EXPRESS AND IMPLIED, INCLUDING WITHOUT LIMITATION ANY IMPLIED WARRANTIES OF MERCHANTABILITY, FITNESS FOR A PARTICULAR PURPOSE OR NON-INFRINGEMENT OF THIRD PARTY INTELLECTUAL PROPERTY RIGHTS.

These resources are intended for skilled developers designing with TI products. You are solely responsible for (1) selecting the appropriate TI products for your application, (2) designing, validating and testing your application, and (3) ensuring your application meets applicable standards, and any other safety, security, or other requirements. These resources are subject to change without notice. TI grants you permission to use these resources only for development of an application that uses the TI products described in the resource. Other reproduction and display of these resources is prohibited. No license is granted to any other TI intellectual property right or to any third party intellectual property right. TI disclaims responsibility for, and you will fully indemnify TI and its representatives against, any claims, damages, costs, losses, and liabilities arising out of your use of these resources.

TI's products are provided subject to TI's Terms of Sale (www.ti.com/legal/termsofsale.html) or other applicable terms available either on ti.com or provided in conjunction with such TI products. TI's provision of these resources does not expand or otherwise alter TI's applicable warranties or warranty disclaimers for TI products.

Mailing Address: Texas Instruments, Post Office Box 655303, Dallas, Texas 75265
Copyright © 2019, Texas Instruments Incorporated

Looking for pricing, stock, or lifecycle information?

Click below to explore more details on WIN SOURCE:

 [View LMV393IPWRG4](#) on WIN SOURCE

 [Texas Instruments](#) Information

Optimize Your Supply Chain with WIN SOURCE Solutions

-  Global Sourcing Solution
-  Obsolete Management
-  Cost Control Management
-  Shortage Management
-  Alternative Solution
-  Excess Inventory Management