



THE DATASHEET OF DS1487MX



DS1487

DS1487 Low Power RS-485 ¼ Unit Load Multipoint Transceiver



Literature Number: SNLS132

DS1487

Low Power RS-485 1/4 Unit Load Multipoint Transceiver

General Description

The DS1487 is a low-power transceiver for RS-485 and RS-422 communication. The device contains one driver and one receiver. The drivers slew rate allows for operation up to 2.0 Mbps (see Applications Information section). The transceiver presents 1/4 unit loading to the RS-485 bus allowing up to 128 nodes to be connected together without the use of repeaters.

The transceiver draws 200 μ A of supply current when unloaded or fully loaded with the driver disabled and operates from a single +5V supply.

The driver is short-circuit current limited and is protected against excessive power dissipation by thermal shutdown circuitry that places the driver outputs into TRI-STATE® (High Impedance state) under fault conditions. The driver guarantees a minimum of 1.5V differential output voltage with maximum loading across the common mode range (V_{OD3}).

The receiver has a failsafe feature that guarantees a logic-high output if the input is open circuit.

The DS1487 is available in surface mount and DIP packages.

Features

- Meets TIA/EIA RS-485 multipoint standard
- Allows up to 128 transceivers on the bus (1/4 U.L.)
- Guaranteed full load output voltage (V_{OD3})
- Low quiescent current: 200 μ A typ
- -7V to +12V common-mode input voltage range
- TRI-STATE outputs on driver and receiver
- AC performance:
 - Driver transition time: 25 ns typ
 - Driver propagation delay: 40 ns typ
 - Driver skew: 1 ns typ
 - Receiver propagation delay: 200 ns typ
 - Receiver skew: 20 ns typ
- Half-duplex flow through pinout
- Operates from a single 5V supply
- Current-limiting and thermal shutdown for driver overload protection
- Pin and functional compatible with MAX1487

Connection and Logic Diagram

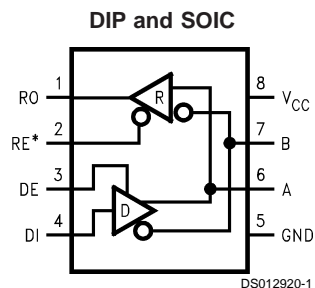

*Note: Non Terminated, Open Input only

Order Number	Temp. Range	Package/###
DS1487N	0°C to +70°C	DIP/N08E
DS1487M	0°C to +70°C	SOP/M08A

Truth Table

DRIVER SECTION				
RE (Note 1)	DE	DI	A	B
X	H	H	H	L
X	H	L	L	H
X	L	X	Z	Z
RECEIVER SECTION				
RE (Note 1)	DE	A-B		RO
L	L	$\geq +0.2V$		H
L	L	$\leq -0.2V$		L
H	X	X		Z
L	L	OPEN (Note 1)		H

X = indeterminate

Z = TRI-STATE

Note 1: Non Terminated, Open Input only

Absolute Maximum Ratings (Note 2)

If Military/Aerospace specified devices are required, please contact the National Semiconductor Sales Office/Distributors for availability and specifications.

Supply Voltage (V_{CC})	+12V
Enable Input Voltage (RE (Note 1), DE)	-0.5V to ($V_{CC} + 0.5V$)
Driver Input Voltage (DI)	-0.5V to ($V_{CC} + 0.5V$)
Driver Output Voltage (A, B)	-14V to +14V
Receiver Input Voltage (A, B)	-14V to +14V
Receiver Output Voltage (RO)	-0.5V to ($V_{CC} + 0.5V$)
Maximum Package Power Dissipation @ +25°C	
M Package	1.19W
N Package	0.74W
Derate M Package 9.5 mW/°C above +25°C	
Derate N Package 6.0 mW/°C above +25°C	
Maximum Package Power Dissipation @ +70°C	

M Package	0.76W
N Package	0.47W
Storage Temperature Range	-65°C to +150°C
Lead Temperature Range (Soldering, 4 sec.)	+260°C
ESD (HBM)	≥2 kV

Recommended Operating Conditions

	Min	Typ	Max	Units
Supply Voltage (V_{CC})	+4.75	+5.0	+5.25	V
Operating Free Air Temperature (T_A)				
DS1487	0	+25	+70	°C
Bus Common Mode Voltage	-7		+12	V

Electrical Characteristics

Over Supply Voltage and Operating Temperature Ranges, unless otherwise specified (Notes 3, 4)

Symbol	Parameter	Conditions	Pin	Min	Typ	Max	Units	
V_{OD1}	Differential Driver Output Voltage	(No Load)	A, B	1.5		5	V	
V_{OD2}	Differential Driver Output Voltage with Load	$R_L = 50\Omega$, (RS422), <i>Figure 1</i> $R_L = 27\Omega$, (RS485), <i>Figure 1</i>		2	2.8		V	
ΔV_{OD}	Change in Magnitude of Output Differential Voltage	$R_L = 27\Omega$ or 50Ω (Note 5)				0.2	V	
V_{OD3}	Differential Driver Output Voltage— Full Load with Max V_{CM}	$R1 = 54\Omega$, $R2 = 375\Omega$ $V_{TEST} = -7V$ to +12V, <i>Figure 2</i>		1.5	2.0	5	V	
V_{OC}	Driver Common-Mode Output Voltage	$R_L = 27\Omega$ or 50Ω , <i>Figure 1</i>		0		3	V	
ΔV_{OC}	Change in Magnitude of Common-Mode Output Voltage	$R_L = 27\Omega$ or 50Ω , <i>Figure 1</i> (Note 5)				0.2	V	
V_{IH}	Input High Voltage		DI, DE, RE (Note 1)	2.0			V	
V_{IL}	Input Low Voltage						0.8	V
I_{IN1}	Input Current	$V_{IN} = 0V$ or V_{CC}				±2	µA	
I_{IN2}	Input Current (Note 6) DE = 0V, $V_{CC} = 0V$ or 5.25V	$V_{IN} = +12V$ $V_{IN} = -7V$	A, B	0	190	250	µA	
V_{TH}	Receiver Differential Threshold Voltage	$-7V \leq V_{CM} \leq +12V$			0	-100	-200	µA
ΔV_{TH}	Receiver Input Hysteresis	$V_{CM} = 0V$		-0.2		0.2	V	
V_{OH}	Receiver Output High Voltage	$I_O = -4$ mA, $V_{ID} = 0.2V$	RO		70		mV	
V_{OL}	Receiver Output Low Voltage	$I_O = 4$ mA, $V_{ID} = -0.2V$			3.5			V
I_{OZR}	TRI-STATE Output Current at Receiver	$0.4V \leq V_O \leq 2.4V$				0.5	V	
R_{IN}	Receiver Input Resistance	$-7V \leq V_{IN} \leq +12V$	A, B			±1	µA	
I_{CC}	No-Load Supply Current (Note 7)	DE = V_{CC} , RE (Note 1) = 0V or V_{CC} DE = 0V, RE (Note 1) = 0V or V_{CC}	V_{CC}		48	68	kΩ	
I_{OSD1}	Driver Short Circuit Current, $V_O =$ HIGH	$-7V \leq V_O \leq +12V$	A, B			200	500	µA
I_{OSD2}	Driver Short Circuit Current, $V_O =$ LOW	$-7V \leq V_O \leq +12V$					200	500
I_{OSR}	Receiver Short Circuit Current	$V_O = GND$	RO	7		85	mA	

Switching Characteristics

Over Supply Voltage and Operating Temperature Ranges, unless otherwise specified (Notes 4, 8, 9)

Symbol	Parameter	Conditions	Min	Typ	Max	Units
t_{PLHD}	Driver Differential Propagation Delay—Low to High	$R_L = 54\Omega, C_L = 100\text{ pF}$	10	40	80	ns
t_{PHLD}	Driver Differential Propagation Delay—High to Low		10	39	80	ns
t_{SKEW}	Differential Skew $ t_{PHLD} - t_{PLHD} $		0	1	10	ns
t_r	Driver Rise Time		3	25	50	ns
t_f	Driver Fall Time		3	25	50	ns
t_{ZH}	Driver Enable to Output High	$C_L = 100\text{ pF}$		50	200	ns
t_{ZL}	Driver Enable to Output Low	$C_L = 100\text{ pF}$		65	200	ns
t_{LZ}	Driver Disable from Output Low	$C_L = 15\text{ pF}$		80	200	ns
t_{HZ}	Driver Disable from Output High	$C_L = 15\text{ pF}$		80	200	ns
t_{PLHD}	Receiver Differential Propagation Delay—Low to High	$C_L = 15\text{ pF (RO)}$	30	190	400	ns
t_{PHLD}	Receiver Differential Propagation Delay—High to Low		30	210	400	ns
t_{SKEW}	Differential Skew $ t_{PHLD} - t_{PLHD} $		0	20	50	ns
t_{ZH}	Receiver Enable to Output High	$C_L = 15\text{ pF}$		45	150	ns
t_{ZL}	Receiver Enable to Output Low			40	150	ns
t_{LZ}	Receiver Disable from Output Low			50	150	ns
t_{HZ}	Receiver Disable from Output High			55	150	ns
f_{max}	Maximum Data Rate	(Note 10)	2.0			Mbps

Note 2: "Absolute Maximum Ratings" are those values beyond which the safety of the device cannot be guaranteed. They are not meant to imply that the devices should be operated at these limits. The table of "Electrical Characteristics" specifies conditions of device operation.

Note 3: Current into device pins is defined as positive. Current out of device pins is defined as negative. All voltages are referenced to ground except $V_{OD1/2/3}$ and V_{ID} .

Note 4: All typicals are given for: $V_{CC} = +5.0V, T_A = +25^\circ C$.

Note 5: $\Delta|V_{OD}|$ and $\Delta|V_{OC}|$ are changes in magnitude of V_{OD} and V_{OC} respectively, that occur when the input changes state.

Note 6: I_{IN2} includes the receiver input current and driver TRI-STATE leakage current.

Note 7: Supply current specification is valid for loaded transmitters when $DE = 0V$ or enabled ($DE = H$) with no load.

Note 8: $f = 1\text{ MHz}, t_r$ and $t_f \leq 6\text{ ns}, Z_0 = 50\Omega$.

Note 9: C_L includes jig and probe capacitance.

Note 10: f_{max} is the guaranteed data rate for 50 ft of twisted pair cable. f_{max} may be conservatively determined from the ratio of driver transition time (t_r) to the data rate unit interval ($1/f_{max}$). Using a 10% ratio yields $f_{max} = (0.1)/50\text{ ns} = 2.0\text{ Mb/s}$. Higher data rates may be supported by allowing larger ratios.

Parameter Measurement Information

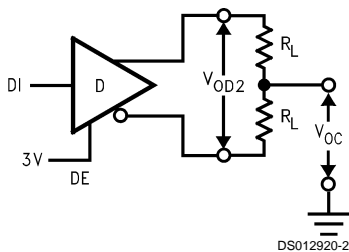

FIGURE 1. V_{OD2}

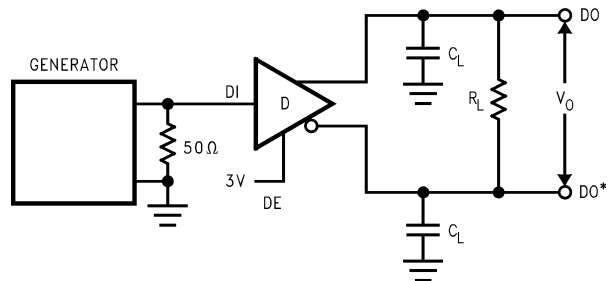

FIGURE 3.

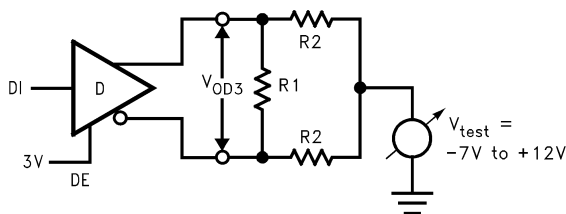

FIGURE 2. V_{OD3}

Parameter Measurement Information (Continued)

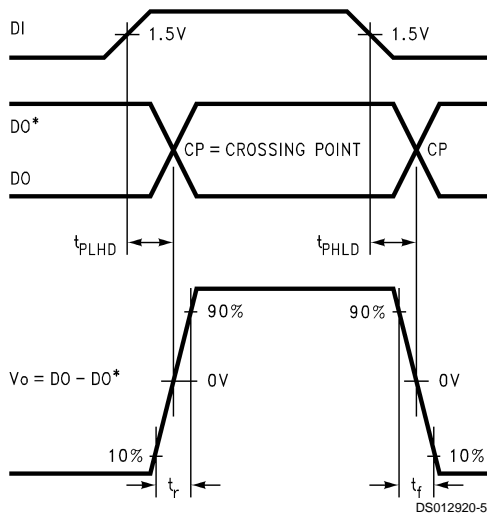

FIGURE 4.

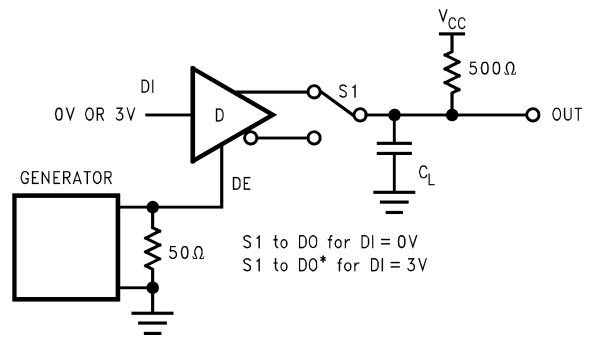

FIGURE 7.

DS012920-8

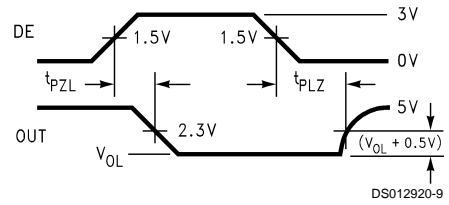

FIGURE 8.

DS012920-9

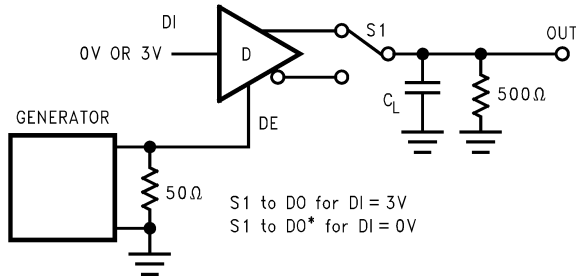

FIGURE 5.

DS012920-6

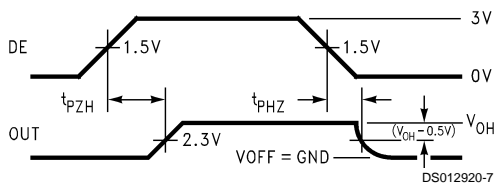

FIGURE 6.

DS012920-7

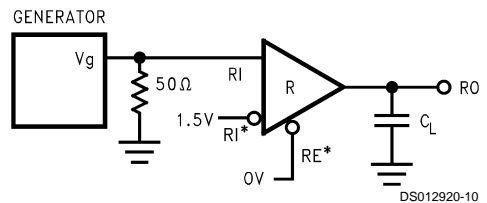

FIGURE 9.

DS012920-10

*Note: Non Terminated, Open Input only

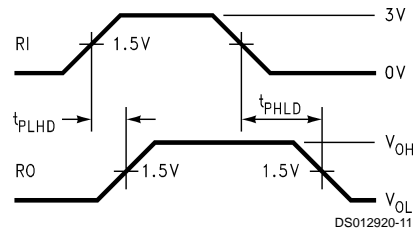
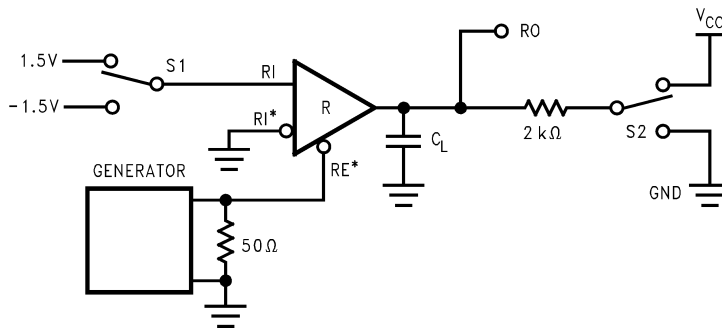

FIGURE 10.

DS012920-11



DS012920-12

*Note: Non Terminated, Open Input only

FIGURE 11.

Parameter Measurement Information (Continued)

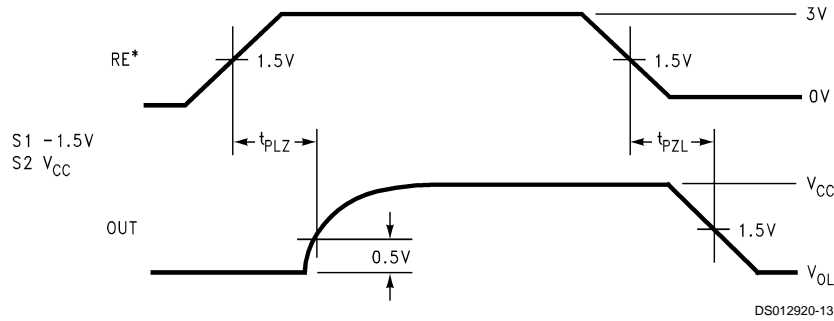

*Note: Non Terminated, Open Input only

FIGURE 12.

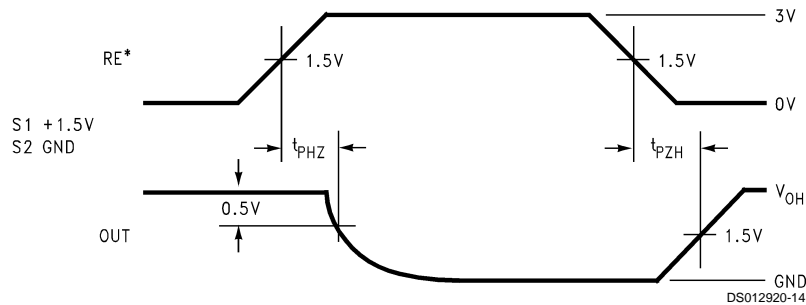

*Note: Non Terminated, Open Input only

FIGURE 13.

Pin Descriptions

Pin #	I/O	Name	Function
1	O	RO	Receiver Output: If $A > B$ by 200 mV, RO will be high; If $A < B$ by 200 mV, RO will be low. RO will be high also if the inputs (A and B) are open (non-terminated).
2	I	RE (Note 1)	Receiver Output Enable: RO is enabled when RE (Note 1) is low; RO is in TRI-STATE when RE (Note 1) is high.
3	I	DE	Driver Output Enable: The driver outputs (A and B) are enabled when DE is high; they are in TRI-STATE when DE is low. Pins A and B also function as the receiver input pins (see below).
4	I	DI	Driver Input: A low on DI forces A low and B high while a high on DI forces A high and B low when the driver is enabled.
5	NA	GND	Ground
6	I/O	A	Non-inverting Driver Output and Receiver Input pin. Driver output levels conform to RS-485 signaling levels.
7	I/O	B	Inverting Driver Output and Receiver Input pin. Driver output levels conform to RS-485 signaling levels.
8	NA	V_{CC}	Power Supply: $4.75V \leq V_{CC} \leq 5.25V$

Applications Information

The DS1487 is a low power transceiver designed for use in RS-485 multipoint applications. The DS1487 can transmit data up to 2.0 Mbps based on a ratio of driver transition time to the unit interval (bit time) of 10%. This maximum data rate may be further limited by the interconnecting media. The DS1487 provides a $\frac{1}{4}$ unit load to the RS-485 bus across the common mode range of $-7V$ to $+12V$. This allows up to 128 transceivers ($\frac{1}{4}$ unit load) to be connected to the bus. The

DS1487 also guarantees the driver's output differential voltage into a worst case load that models standard termination loads and 32 unit loads (=128 DS1487's) referenced to the maximum common mode voltage extremes. With a minimum of 1.5V swing into this load, a 1.3V differential noise margin is supported along with the standard common mode rejection range of the receivers.

Applications Information (Continued)

Due to the multipoint nature of the bus, contention between drivers may occur. This will not cause damage to the drivers since they feature short-circuit protection and also thermal shutdown protection. Thermal shutdown senses die temperature and puts the driver outputs into TRI-STATE if a fault condition occurs that causes excessive power dissipation which can elevate the junction temperature to $+150^{\circ}\text{C}$.

A typical multipoint application is shown in the following figure. Note that termination is typically required but is only located at the two ends of the cable (not on every node). Commonly pull up and pull down resistors may be required at one end of the bus to provide a failsafe bias. These resistors provide a bias to the line when all drivers are in TRI-STATE. See National Application Note 847 for a complete discussion of failsafe biasing of differential buses.

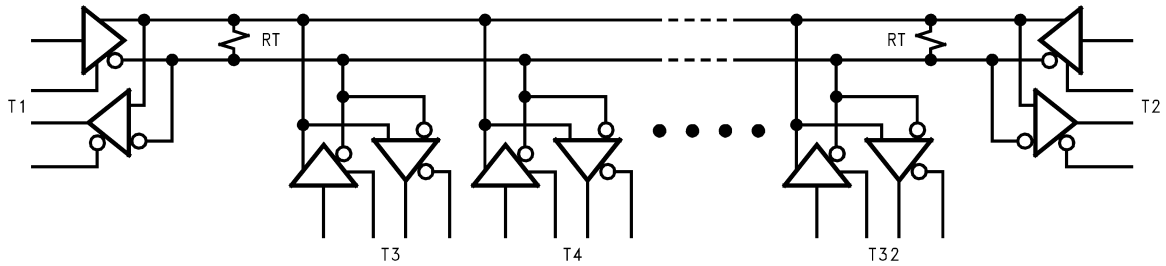

DS012920-16

Physical Dimensions inches (millimeters) unless otherwise noted

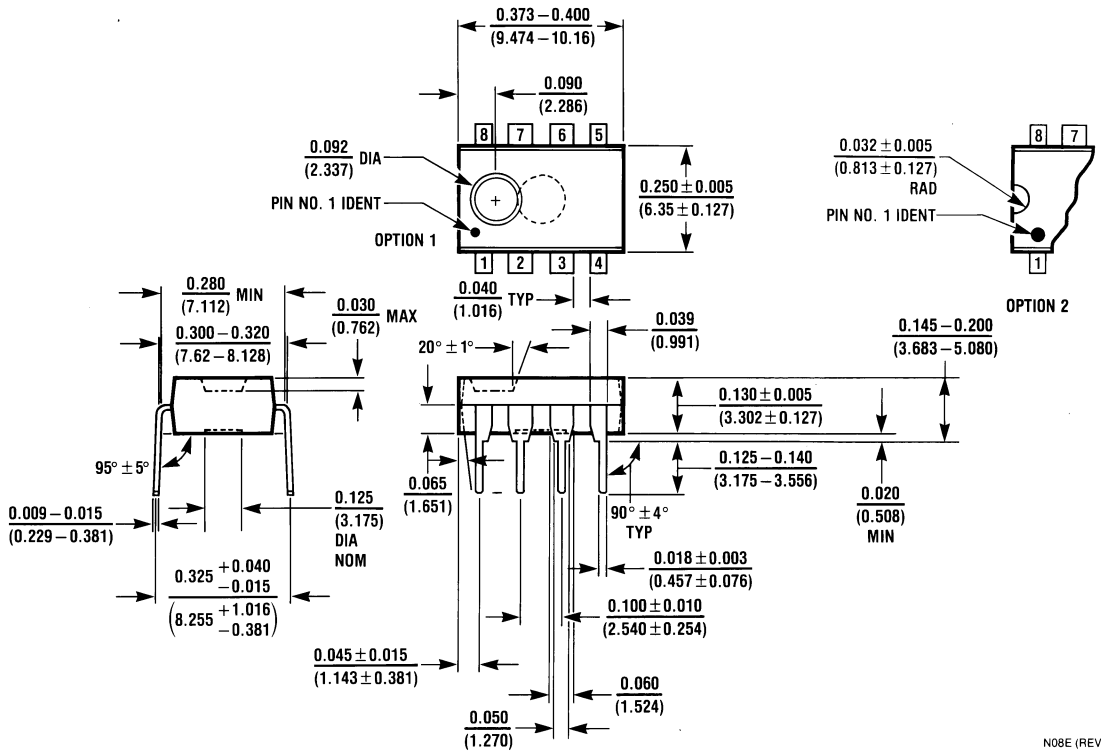
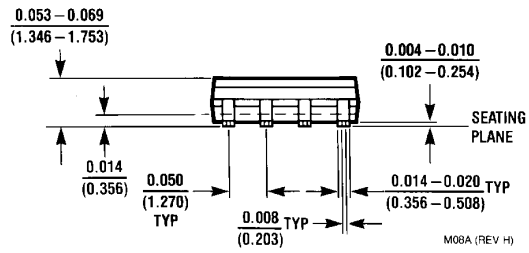
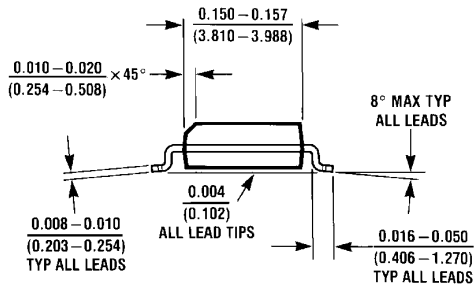
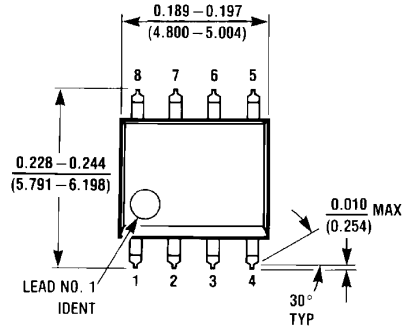

Order Number DS1487N
 NS Package Number N08E

N08E (REV F)

Notes

LIFE SUPPORT POLICY

NATIONAL'S PRODUCTS ARE NOT AUTHORIZED FOR USE AS CRITICAL COMPONENTS IN LIFE SUPPORT DEVICES OR SYSTEMS WITHOUT THE EXPRESS WRITTEN APPROVAL OF THE PRESIDENT AND GENERAL COUNSEL OF NATIONAL SEMICONDUCTOR CORPORATION. As used herein:

1. Life support devices or systems are devices or systems which, (a) are intended for surgical implant into the body, or (b) support or sustain life, and whose failure to perform when properly used in accordance with instructions for use provided in the labeling, can be reasonably expected to result in a significant injury to the user.
2. A critical component is any component of a life support device or system whose failure to perform can be reasonably expected to cause the failure of the life support device or system, or to affect its safety or effectiveness.



National Semiconductor Corporation
Americas
Tel: 1-800-272-9959
Fax: 1-800-737-7018
Email: support@nsc.com
www.national.com

National Semiconductor Europe
Fax: +49 (0) 180-530 85 86
Email: europe.support@nsc.com
Deutsch Tel: +49 (0) 69 9508 6208
English Tel: +44 (0) 870 24 0 2171
Français Tel: +33 (0) 1 41 91 87 90

National Semiconductor Asia Pacific Customer Response Group
Tel: 65-2544466
Fax: 65-2504466
Email: ap.support@nsc.com

National Semiconductor Japan Ltd.
Tel: 81-3-5639-7560
Email: nsj.crc@jksmtp.nsc.com
Fax: 81-3-5639-7507

IMPORTANT NOTICE

Texas Instruments Incorporated and its subsidiaries (TI) reserve the right to make corrections, modifications, enhancements, improvements, and other changes to its products and services at any time and to discontinue any product or service without notice. Customers should obtain the latest relevant information before placing orders and should verify that such information is current and complete. All products are sold subject to TI's terms and conditions of sale supplied at the time of order acknowledgment.

TI warrants performance of its hardware products to the specifications applicable at the time of sale in accordance with TI's standard warranty. Testing and other quality control techniques are used to the extent TI deems necessary to support this warranty. Except where mandated by government requirements, testing of all parameters of each product is not necessarily performed.

TI assumes no liability for applications assistance or customer product design. Customers are responsible for their products and applications using TI components. To minimize the risks associated with customer products and applications, customers should provide adequate design and operating safeguards.

TI does not warrant or represent that any license, either express or implied, is granted under any TI patent right, copyright, mask work right, or other TI intellectual property right relating to any combination, machine, or process in which TI products or services are used. Information published by TI regarding third-party products or services does not constitute a license from TI to use such products or services or a warranty or endorsement thereof. Use of such information may require a license from a third party under the patents or other intellectual property of the third party, or a license from TI under the patents or other intellectual property of TI.

Reproduction of TI information in TI data books or data sheets is permissible only if reproduction is without alteration and is accompanied by all associated warranties, conditions, limitations, and notices. Reproduction of this information with alteration is an unfair and deceptive business practice. TI is not responsible or liable for such altered documentation. Information of third parties may be subject to additional restrictions.

Resale of TI products or services with statements different from or beyond the parameters stated by TI for that product or service voids all express and any implied warranties for the associated TI product or service and is an unfair and deceptive business practice. TI is not responsible or liable for any such statements.

TI products are not authorized for use in safety-critical applications (such as life support) where a failure of the TI product would reasonably be expected to cause severe personal injury or death, unless officers of the parties have executed an agreement specifically governing such use. Buyers represent that they have all necessary expertise in the safety and regulatory ramifications of their applications, and acknowledge and agree that they are solely responsible for all legal, regulatory and safety-related requirements concerning their products and any use of TI products in such safety-critical applications, notwithstanding any applications-related information or support that may be provided by TI. Further, Buyers must fully indemnify TI and its representatives against any damages arising out of the use of TI products in such safety-critical applications.

TI products are neither designed nor intended for use in military/aerospace applications or environments unless the TI products are specifically designated by TI as military-grade or "enhanced plastic." Only products designated by TI as military-grade meet military specifications. Buyers acknowledge and agree that any such use of TI products which TI has not designated as military-grade is solely at the Buyer's risk, and that they are solely responsible for compliance with all legal and regulatory requirements in connection with such use.

TI products are neither designed nor intended for use in automotive applications or environments unless the specific TI products are designated by TI as compliant with ISO/TS 16949 requirements. Buyers acknowledge and agree that, if they use any non-designated products in automotive applications, TI will not be responsible for any failure to meet such requirements.

Following are URLs where you can obtain information on other Texas Instruments products and application solutions:

Products

Audio	www.ti.com/audio
Amplifiers	amplifier.ti.com
Data Converters	dataconverter.ti.com
DLP® Products	www.dlp.com
DSP	dsp.ti.com
Clocks and Timers	www.ti.com/clocks
Interface	interface.ti.com
Logic	logic.ti.com
Power Mgmt	power.ti.com
Microcontrollers	microcontroller.ti.com
RFID	www.ti-rfid.com
OMAP Mobile Processors	www.ti.com/omap
Wireless Connectivity	www.ti.com/wirelessconnectivity

Applications

Communications and Telecom	www.ti.com/communications
Computers and Peripherals	www.ti.com/computers
Consumer Electronics	www.ti.com/consumer-apps
Energy and Lighting	www.ti.com/energy
Industrial	www.ti.com/industrial
Medical	www.ti.com/medical
Security	www.ti.com/security
Space, Avionics and Defense	www.ti.com/space-avionics-defense
Transportation and Automotive	www.ti.com/automotive
Video and Imaging	www.ti.com/video

TI E2E Community Home Page

e2e.ti.com

Mailing Address: Texas Instruments, Post Office Box 655303, Dallas, Texas 75265
Copyright © 2011, Texas Instruments Incorporated







Looking for pricing, stock, or lifecycle information?

Click below to explore more details on WIN SOURCE:

 [View DS1487MX](#) on WIN SOURCE

 [Texas Instruments](#) Information

Optimize Your Supply Chain with WIN SOURCE Solutions

-  Global Sourcing Solution
-  Obsolete Management
-  Cost Control Management
-  Shortage Management
-  Alternative Solution
-  Excess Inventory Management