



**THE DATASHEET OF
ADT7488AARMZ-REEL7**



ADT7488A

SST Digital Temperature Sensor and Voltage Monitor

The ADT7488A is a simple digital temperature sensor for use in PC applications with Simple Serial Transport (SST) interface. It can monitor its own temperature as well as the temperature of two remote sensor diodes. It also measures the processor core voltage, V_{CCP} ; a 2.5 V supply voltage; and its own supply voltage, V_{CC} . The ADT7488A is controlled by an SST single bidirectional data line. This device is a fixed-address SST client where the target address is chosen by the state of the address pin, ADD.

Features

- 1 On-Chip Temperature Sensor
- 2 Remote Temperature Sensors
- Monitors 3 Voltage Inputs, Including V_{CC}
- Simple Serial Transport (SST) Interface
- This Device is Pb-Free, Halogen Free and is RoHS Compliant

Applications

- Personal Computers
- Portable Personal Devices
- Industrial Sensor Nets

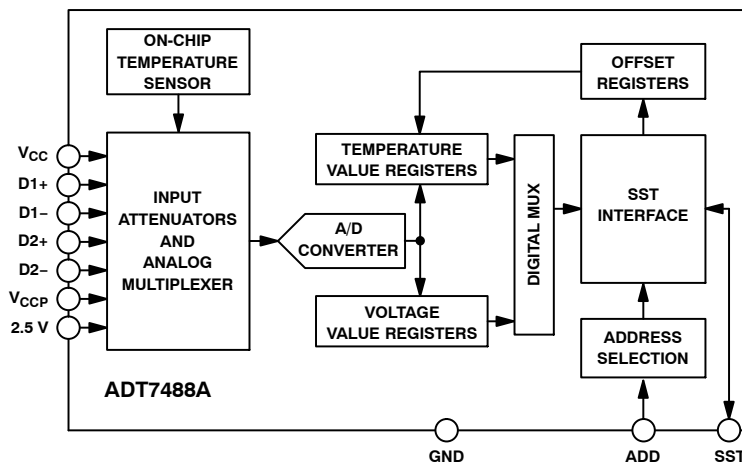
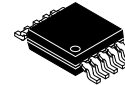

Figure 1. Functional Block Diagram



ON Semiconductor®

<http://onsemi.com>



MSOP-10
CASE 846AC

PIN ASSIGNMENT

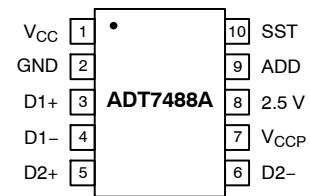

(Top View)

MARKING DIAGRAM

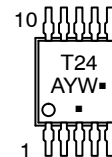

T24 = Specific Device Code
A = Assembly Location
Y = Year
W = Work Week
▪ = Pb-Free Package

(Note: Microdot may be in either location)

ORDERING INFORMATION

See detailed ordering and shipping information in the package dimensions section on page 12 of this data sheet.

ADT7488A

Table 1. PIN ASSIGNMENT

| Pin No. | Mnemonic | Type | Description |
|---------|------------------|----------------------|--|
| 1 | V _{CC} | Power Supply | 3.3 V ±10%. V _{CC} is also Monitored through this Pin |
| 2 | GND | Ground | Ground Pin |
| 3 | D1+ | Analog Input | Positive Connection to Remote 1 Temperature Sensor |
| 4 | D1- | Analog Input | Negative Connection to Remote 1 Temperature Sensor |
| 5 | D2+ | Analog Input | Positive Connection to Remote 2 Temperature Sensor |
| 6 | D2- | Analog Input | Negative Connection to Remote 2 Temperature Sensor |
| 7 | V _{CCP} | Analog Input | Processor Core Voltage Monitor |
| 8 | 2.5 V | Analog Input | 2.5 V Supply Monitor |
| 9 | ADD | Digital Input | SST Address Select |
| 10 | SST | Digital Input/Output | SST Bidirectional Data Line |

Table 2. ABSOLUTE MAXIMUM RATINGS

| Parameter | Rating | Unit |
|---|--------------|------|
| Supply Voltage (V _{CC}) | 4.0 | V |
| Voltage on 2.5 V and V _{CCP} Pins | 3.6 | V |
| Voltage on Any Other Pin (Including SST Pin) | -0.3 to +3.6 | V |
| Input Current at Any Pin | ±5.0 | mA |
| Package Input Current | ±20 | mA |
| Maximum Junction Temperature (T _{J MAX}) | 150 | °C |
| Storage Temperature Range | -65 to +150 | °C |
| Lead Temperature, Soldering IR Peak Re-flow Temperature Lead Temperature (10 sec) | 260 300 | °C |
| ESD Rating | 1,500 | V |

Stresses exceeding Maximum Ratings may damage the device. Maximum Ratings are stress ratings only. Functional operation above the Recommended Operating Conditions is not implied. Extended exposure to stresses above the Recommended Operating Conditions may affect device reliability.

NOTE: This device is ESD sensitive. Use standard ESD precautions when handling.

Table 3. THERMAL CHARACTERISTICS (Note 1)

| Package Type | θ _{JA} | θ _{JC} | Unit |
|--------------|-----------------|-----------------|------|
| 10-lead MSOP | 206 | 44 | °C/W |

1. θ_{JA} is specified for the worst-case conditions, that is, a device soldered in a circuit board for surface-mount packages.

ADT7488A

Table 4. ELECTRICAL CHARACTERISTICS

 (T_A = T_{MIN} to T_{MAX}, V_{CC} = V_{MIN} to V_{MAX}, unless otherwise noted)

| Parameter | Test Conditions/Comments | Min | Typ | Max | Unit |
|--|---|-------------|-----------------|-----------------------|--------|
| Power Supply | | | | | |
| Supply Voltage, V _{CC} | | 3.0 | 3.3 | 3.6 | V |
| Undervoltage Lockout Threshold | | – | 2.8 | – | V |
| Average Operating Supply Current, I _{DD} | Continuous Conversions | – | 3.8 | 5.0 | mA |
| Temperature-to-Digital Converter | | | | | |
| Local Sensor Accuracy | 40°C ≤ T _A ≤ 70°C; V _{CC} = 3.3 V ±5% –40°C ≤ T _A ≤ +100°C | – – | +1.0 – | ±1.75 ±4.0 | °C |
| Remote Sensor Accuracy | –40°C ≤ T _D ≤ +125°C; T _A = 25°C; V _{CC} = 3.3 V –40°C ≤ T _D ≤ +125°C; –40 ≤ T _A ≤ 70°C; V _{CC} = 3.3 V ±5% –40°C ≤ T _D ≤ +125°C; –40 ≤ T _A ≤ +100°C | – – – | – +1.0 – | ±1.0 ±1.75 ±4.0 | °C |
| Remote Sensor Source Current | Low Level Mid Level High Level | – – – | 12 80 204 | – – – | μA |
| Resolution | | – | 0.016 | – | °C |
| Series Resistance Cancellation | The ADT7488A Cancels 1.5 kΩ in Series with the Remote Thermal Diode | – | 1.5 | – | kΩ |
| Digital Input (ADD) | | | | | |
| Input High Voltage, V _{IH} | | 2.3 | – | – | V |
| Input Low Voltage, V _{IL} | | – | – | 0.8 | V |
| Input High Current, I _{IH} | V _{IN} = V _{CC} | –1.0 | – | – | μA |
| Input Low Current, I _{IL} | V _{IN} = 0 | – | – | 1.0 | μA |
| Pin Capacitance | | – | 5.0 | – | pF |
| Analogue-to-Digital Converter (Including Multiplexer and Attenuators) | | | | | |
| Total Unadjusted Error (TUE) | | – | – | ±1.5 | % |
| Differential Non-linearity (DNL) | 10 Bits | – | – | ±1.0 | LSB |
| Power Supply Sensitivity | | – | ±0.1 | – | %/V |
| Conversion Time (Voltage Input) (Note 1) | Averaging Enabled | – | – | 11 | ms |
| Conversion Time (Local Temperature) (Note 1) | Averaging Enabled | – | – | 12 | ms |
| Conversion Time (Remote Temperature) (Note 1) | Averaging Enabled | – | – | 38 | ms |
| Total Monitoring Cycle Time (Note 1) | Averaging Enabled | – | 121 | – | ms |
| Input Resistances V _{CCP} and 2.5 V Channels | | 80 | 110 | 140 | kΩ |
| Digital I/O (SST Pin) | | | | | |
| Input High Voltage, V _{IH} | | 1.1 | – | – | V |
| Input Low Voltage, V _{IL} | | – | – | 0.4 | V |
| Hysteresis (Note 1) | Between Input Switching Levels | – | 150 | – | mV |
| Output High Voltage, V _{OH} | I _{SOURCE} = 6 mA (Maximum) | 1.1 | – | 1.9 | V |
| High Impedance State Leakage, I _{LEAK} | Device Powered On SST Bus; V _{SST} = 1.1 V, V _{CC} = 3.3 V | – | – | ±1.0 | μA |
| High Impedance State Leakage, I _{LEAK} | Device Non-powered On SST Bus; V _{SST} = 1.1 V, V _{CC} = 0 V | – | – | ±10 | μA |
| Signal Noise Immunity, V _{NOISE} | Noise Glitches from 10 MHz to 100 MHz; Width Up to 50 ns | 300 | – | – | mV p-p |

ADT7488A

Table 4. ELECTRICAL CHARACTERISTICS (continued)
 ($T_A = T_{MIN}$ to T_{MAX} , $V_{CC} = V_{MIN}$ to V_{MAX} , unless otherwise noted)

| Parameter | Test Conditions/Comments | Min | Typ | Max | Unit |
|---|---|-----------------------|-----------------------|------------------------|---------|
| SST Timing | | | | | |
| Bitwise Period, t_{BIT} | | 0.495 | – | 500 | μ s |
| High Level Time for Logic 1, t_{H1} (Note 2) | t_{BIT} Defined in Speed Negotiation | $0.6 \times t_{BIT}$ | $0.75 \times t_{BIT}$ | $0.8 \times t_{BIT}$ | μ s |
| High Level Time for Logic 0, t_{H0} (Note 2) | | $0.2 \times t_{BIT}$ | $0.25 \times t_{BIT}$ | $0.4 \times t_{BIT}$ | μ s |
| Time to Assert SST High for Logic 1, $t_{SU, HIGH}$ | | – | – | $0.2 \times t_{BIT}$ | μ s |
| Hold Time, t_{HOLD} (Note 3) | See SST Specification Rev 1.0 | – | – | $0.5 \times t_{BIT-M}$ | μ s |
| Stop Time, t_{STOP} | Device Responding to a Constant Low Level Driven by Originator | $1.25 \times t_{BIT}$ | $2 \times t_{BIT}$ | $2 \times t_{BIT}$ | μ s |
| Time to Respond After a Reset, t_{RESET} | | – | – | 0.4 | ms |
| Response Time to Speed Negotiation After Powerup | Time after Powerup when Device Can Participate in Speed Negotiation | – | 500 | – | μ s |

1. Guaranteed by design, not production tested.
2. Minimum and maximum bit times are relative to t_{BIT} defined in the timing negotiation pulse.
3. Device is compatible with hold time specification as driven by SST originator.

TYPICAL PERFORMANCE CHARACTERISTICS

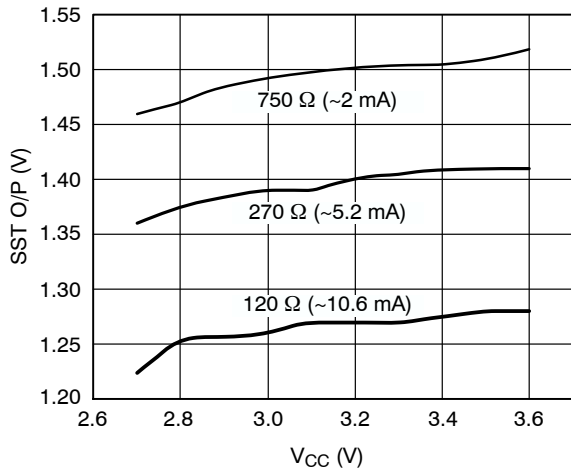

Figure 2. SST O/P Level vs. Supply Voltage

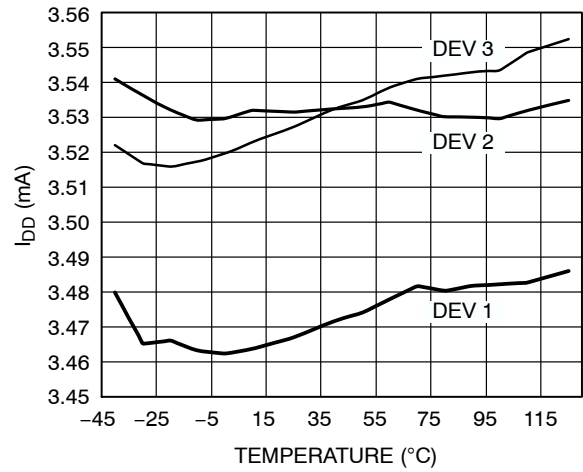

Figure 3. Supply Current vs. Temperature

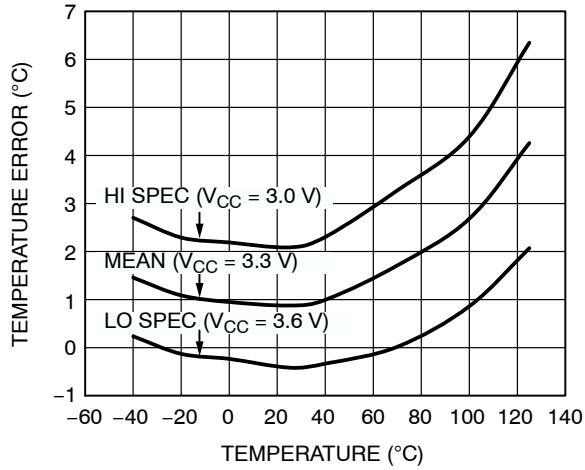

Figure 4. Local Temperature Error

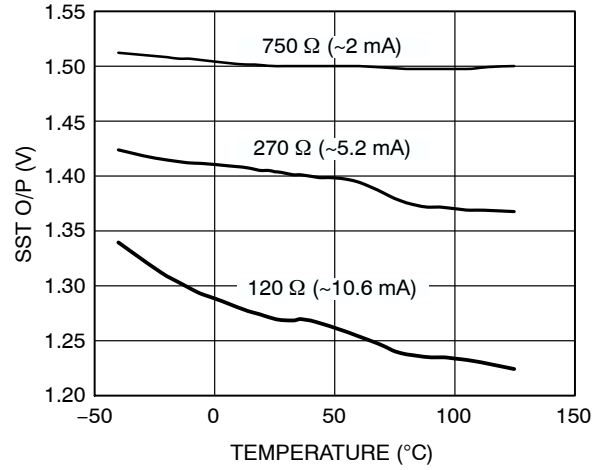

Figure 5. SST O/P Level vs. Temperature

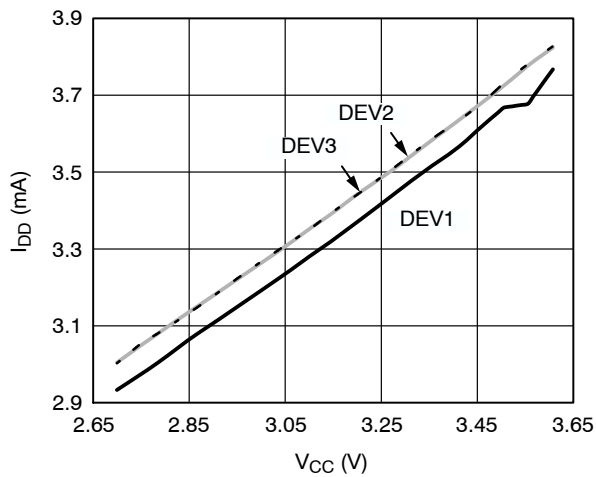

Figure 6. Supply Current vs. Voltage

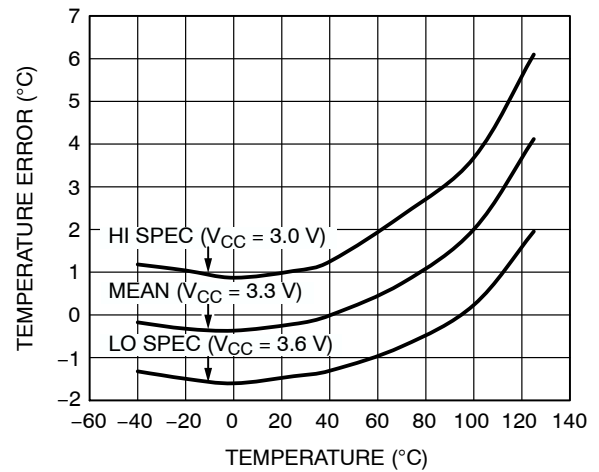

Figure 7. Remote Temperature Error

TYPICAL PERFORMANCE CHARACTERISTICS (Cont'd)

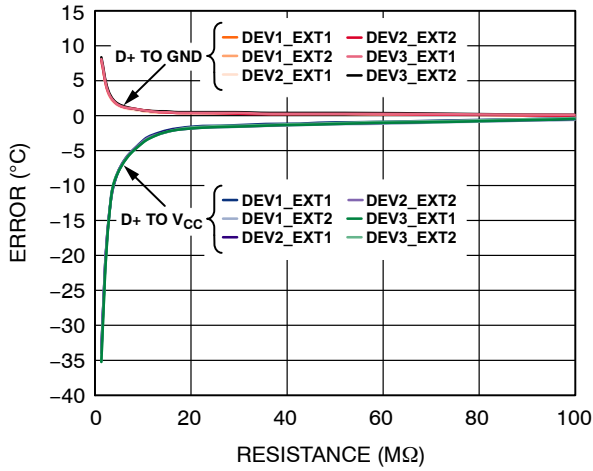

Figure 8. Remote Temperature Error vs. PCB Resistance

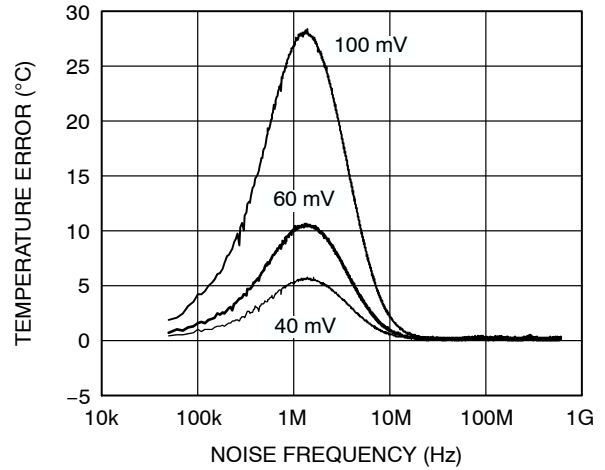

Figure 9. Temperature Error vs. Common-Mode Noise Frequency

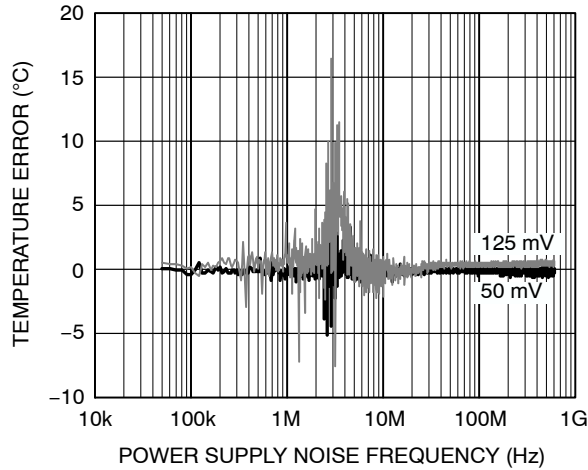

Figure 10. Local Temperature Error vs. Power Supply Noise

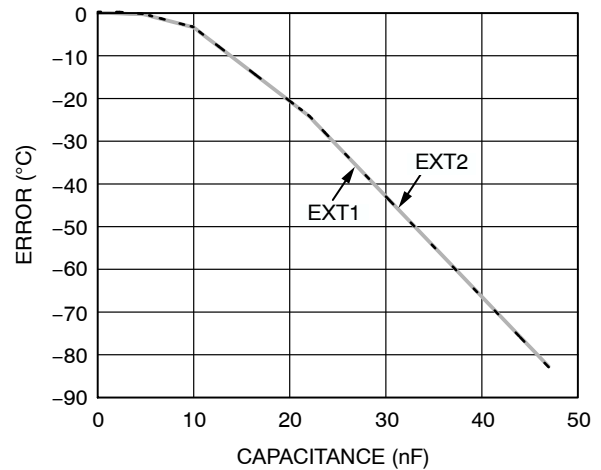

Figure 11. Remote Temperature Error vs. Capacitance Between D1+ and D1-

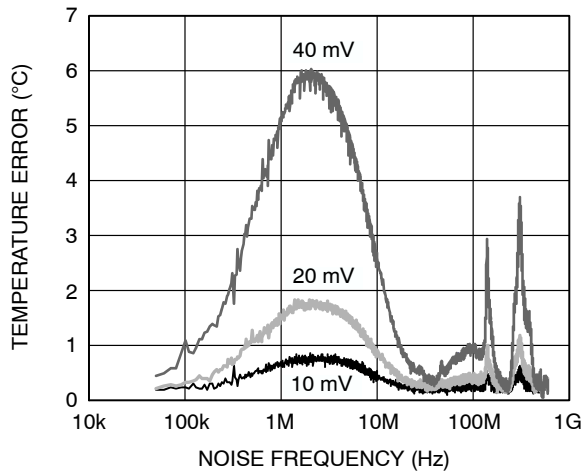

Figure 12. Temperature Error vs. Differential-Mode Noise Frequency

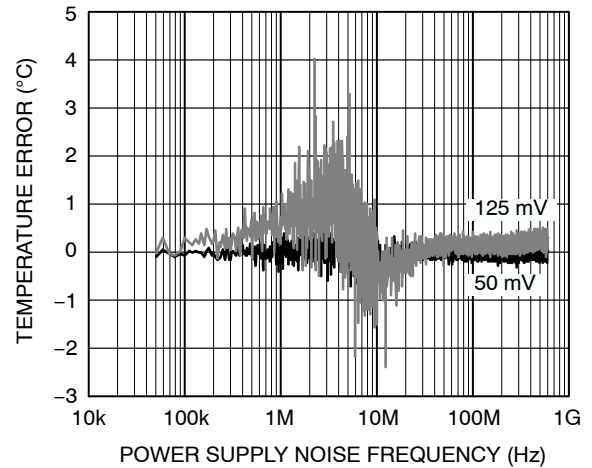

Figure 13. Remote Temperature Error vs. Power Supply Noise

ADT7488A

Product Description

The ADT7488A is a temperature- and voltage-monitoring device. The ADT7488A can monitor the temperature of two remote sensor diodes, plus its own internal temperature. It can also monitor up to three voltage channels, including its own supply voltage.

SST Interface

Simple Serial Transport (SST) is a one-wire serial bus and a communications protocol between components intended for use in personal computers, personal hand-held devices, or other industrial sensor nets. The ADT7488A supports SST Rev 1.0.

SST is a licensable bus technology from Analog Devices, Inc., and Intel Corporation. To inquire about obtaining a copy of the Simple Serial Transport Specification or an SST technology license, please email Analog Devices at sss_licensing@analog.com or write to Analog Devices, 3550 North First Street, San Jose, CA 95134, Attention: SST Licensing, M/S B7-24.

ADT7488A Client Address

The client address for the ADT7488A is selected using the address pin. The address pin is connected to a float detection circuit, which allows the ADT7488A to distinguish between three input states: high, low (GND), and floating. The address range for the fixed address, discoverable device is 0x48 to 0x4A.

Table 5. ADT7488A SELECTABLE ADDRESSES

| ADD | Address Selected |
|-----------|------------------|
| Low (GND) | 0x48 |
| Float | 0x49 |
| High | 0x4A |

Command Summary

Table 6 summarizes the commands supported by the ADT7488A device when directed at the target address selected by the fixed address pin. It contains the command name, command code (CC), write data length (WL), read data length (RL), and a brief description.

Table 6. COMMAND CODE SUMMARY

| Command | Command Code, CC | Write Length, WL | Read Length, RL | Description |
|-----------------|------------------|------------------|-----------------|--|
| Ping() | 0x00 | 0x00 | 0x00 | Shows a nonzero FCS over the header if present. |
| GetIntTemp() | 0x00 | 0x01 | 0x02 | Shows the temperature of the device's internal thermal diode. |
| GetExt1Temp() | 0x01 | 0x01 | 0x02 | Shows the temperature of External Thermal Diode 1. |
| GetExt2Temp() | 0x02 | 0x01 | 0x02 | Shows the temperature of External Thermal Diode 2. |
| GetAllTemps() | 0x00 | 0x01 | 0x06 | Returns a 6-byte block of data (GetIntTemp, GetExt1Temp, GetExt2Temp). |
| GetVoltVCC() | 0x12 | 0x01 | 0x02 | Shows the voltage attached to V _{CC} input. |
| GetVolt2.5V() | 0x13 | 0x01 | 0x02 | Shows the voltage attached to 2.5 V input. |
| GetVoltVCCP() | 0x14 | 0x01 | 0x02 | Shows the voltage attached to V _{CCP} input. |
| GetAllVolts() | 0x12 | 0x01 | 0x06 | Shows all voltage measurements in a 6-byte block of data (GetVoltVcc, GetVolt2.5, GetVoltVccp). |
| SetExt1Offset() | 0xe0 | 0x03 | 0x00 | Sets the offset used to correct errors in External Diode 1. |
| GetExt1Offset() | 0xe0 | 0x01 | 0x02 | Shows the offset that the device is using to correct errors in External Diode 1. |
| SetExt2Offset() | 0xe1 | 0x03 | 0x00 | Sets the offset used to correct errors in External Diode 2. |
| GetExt2Offset() | 0xe1 | 0x01 | 0x02 | Returns the offset the device is using to correct errors in External Diode 2. |
| ResetDevice() | 0xf6 | 0x01 | 0x00 | Functional reset. The ADT7488A also responds to this command when directed to the Target Address 0x00. |
| GetDIB() | 0xf7 0xf7 | 0x01 0x01 | 0x08 0x10 | Shows information used by SW to identify the device's capabilities. Can be in 8- or 16-byte format. |

Command Code Details

ADT7488A Device Identifier Block

The GetDIB() command retrieves the device identifier block (DIB), which provides information to identify the capabilities of the ADT7488A. The data returned can be in 8- or 16-byte format. The full 16 bytes of DIB is detailed in

Table 7. The 8-byte format involves the first eight bytes described in this table. Byte-sized data is returned in the respective fields as it appears in Table 7. Word-sized data, including vendor ID, device ID, and data values use little endian format, that is, the LSB is returned first, followed by the MSB.

Table 7. 16-BYTE DIB DETAILS

| Byte | Name | Value | Description |
|------|-----------------------|--------------|--|
| 0 | Device Capabilities | 0xc0 | Fixed Address Device |
| 1 | Version/Revision | 0x10 | Meets Version 1 of SST Specification |
| 2, 3 | Vendor ID | 00x11d4 | Contains Company ID Number in Little Endian Format |
| 4, 5 | Device ID | 0x7488 | Contains Device ID Number in Little Endian Format |
| 6 | Device Interface | 0x01 | SST Device |
| 7 | Function Interface | 0x00 | Reserved |
| 8 | Reserved | 0x00 | Reserved |
| 9 | Reserved | 0x00 | Reserved |
| 10 | Reserved | 0x00 | Reserved |
| 11 | Reserved | 0x00 | Reserved |
| 12 | Reserved | 0x00 | Reserved |
| 13 | Reserved | 0x00 | Reserved |
| 14 | Revision ID | 0x05 | Contains Revision ID |
| 15 | Client Device Address | 0x48 to 0x4a | Dependent on the State of Address Pin |

Ping()

The Ping() command verifies if a device is responding at a particular address. The ADT7488A shows a valid non-zero FCS in response to the Ping() command when correctly addressed.

Table 8. PING() COMMAND

| Target Address | Write Length | Read Length | FCS |
|-----------------|--------------|-------------|-----|
| (Not Necessary) | 0x00 | 0x00 | |

ResetDevice()

This command resets the register map and conversion controller. The reset command can be global or directed at the client address of the ADT7488A.

Table 9. RESETDEVICE() COMMAND

| Target Address | Write Length | Read Length | Reset Command | FCS |
|----------------|--------------|-------------|---------------|-----|
| Device Address | 0x01 | 0x00 | 0xf6 | |

GetIntTemp()

The ADT7488A shows the local temperature of the device in response to the GetIntTemp() command. The data has a little endian, 16-bit, twos complement format.

GetExt1Temp()

Prompted by the GetExt1Temp() command, the ADT7488A shows the temperature of Remote Diode 1 in little endian, 16-bit, twos complement format. The

ADT7488A shows 0x8000 in response to this command if the external diode is an open or short circuit.

GetExt2Temp()

Prompted by the GetExt2Temp() command, ADT7488A shows the temperature of Remote Diode 2 in little endian, 16-bit, twos complement format. The ADT7488A shows 0x8000 in response to this command if the external diode is an open or short circuit.

GetAllTemps()

The ADT7488A shows the local and remote temperatures in a 6-byte block of data (internal temperature first, followed by External 1 temperature, followed by External 2 temperature) in response to a GetAllTemps() command.

SetExtOffset()

This command sets the offset that the ADT7488A will use to correct errors in the external diode. The offset is set in little endian, 16-bit, twos complement format. The maximum offset is $\pm 128^{\circ}\text{C}$ with $+0.25^{\circ}\text{C}$ resolution.

GetExtOffset()

This command causes the ADT7488A to show the offset that it is using to correct errors in the external diode. The offset value is returned in little endian format, that is, LSB before MSB.

ADT7488A Response to Unsupported Commands

A full list of command codes supported by the ADT7488A is given in Table 6. The offset registers (Command Code 0xe0) are the only registers that the user can write to. The other defined registers are read only. Writing to Register Addresses 0x02, 0x09, and 0x15 to 0xdf shows a valid FSC, but no action is taken by the ADT7488A. The ADT7488A shows an invalid FSC if the user attempts to write to the device between Command Codes 0xe2 to 0xee. These registers are reserved for the manufacturer's use only, and no data can be written to the device via these addresses.

Voltage Measurement

The ADT7488A has two external voltage measurement channels. It can also measure its own supply voltage, V_{CC} . Pins 7 and 8 measure the supplies of the processor core voltage (V_{CCP}), and 2.5 V pins, respectively. The V_{CC} supply voltage measurement is carried out through the V_{CC} pin (Pin 1). The 2.5 V pin can be used to monitor a chip-set supply voltage in a computer system.

Analog-to-Digital Converter

All analog inputs are multiplexed into the on-chip, successive approximation, analog-to-digital converter (ADC). This has a resolution of 10 bits. The basic input range is 0 V to 2.25 V, but the inputs have built-in attenuators to allow measurement of 2.5 V, 3.3 V, 5.0 V,

12 V, and the processor core voltage (V_{CCP}) without any external components.

To allow for the tolerance of these supply voltages, the ADC produces a specific output for each nominal input voltage and therefore has adequate headroom to cope with overvoltage. The full-scale voltage that can be recorded for each channel is shown in Table 10.

Table 10. MAXIMUM REPORTED INPUT VOLTAGES

| Voltage Channel | Full-scale Voltage |
|-----------------|--------------------|
| V_{CC} | 4.0 V |
| 2.5 V | 4.0 V |
| V_{CCP} | 4.0 V |

Input Circuitry

The internal structure for the analog inputs is shown in Figure 14. The input circuit consists of an input protection diode and an attenuator, plus a capacitor that forms a first-order, low-pass filter to provide input immunity to high frequency noise.

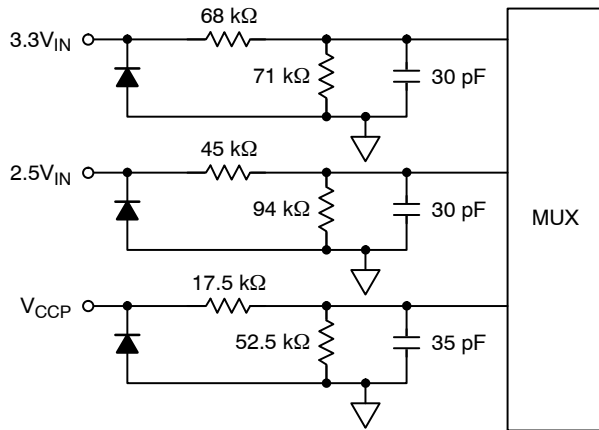

Figure 14. Internal Structure of Analog Inputs

Voltage Measurement Command Codes

The voltage measurement command codes are detailed in Table 11. Each voltage measurement has a read length of two bytes in little endian format (LSB followed by MSB). All voltages can be read together by addressing Command Code 0x12 with a read length of 0x06. The data is retrieved in the order listed in Table 11.

Table 11. VOLTAGE MEASUREMENT COMMAND CODE

| Voltage Channel | Command Code | Returned Data |
|-----------------|--------------|---------------|
| V_{CC} | 0x12 | LSB, MSB |
| 2.5 V | 0x13 | LSB, MSB |
| V_{CCP} | 0x14 | LSB, MSB |

Voltage Data Format

The returned voltage value is in twos complement, 16-bit, binary format. The format is structured so that voltages in the range of ± 32 V can be reported. In this way, the reported

value represents the number of 1/1024 V in the actual reading, allowing a resolution of approximately 1 mV.

Table 12. ANALOG-TO-DIGITAL OUTPUT VS. V_{IN}

| Voltage | Twos Complement | |
|---------|-----------------|-----------|
| | LSB | MSB |
| 3.3 | 0000 1101 | 0011 0011 |
| 3.0 | 0000 1100 | 0000 0000 |
| 2.5 | 0000 1010 | 0000 0000 |
| 1.0 | 0000 0100 | 0000 0000 |
| 0 | 0000 0000 | 0000 0000 |

Temperature Measurement

The ADT7488A has three dedicated temperature measurement channels: one for measuring the temperature of an on-chip band gap temperature sensor, and two for measuring the temperature of a remote diode, usually located in the CPU or GPU.

The ADT7488A monitors one local and two remote temperature channels. Monitoring of each of the channels is done in a round-robin sequence. The monitoring sequence is in the order shown in Table 13.

Table 13. TEMPERATURE MONITORING SEQUENCE

| Channel Number | Measurement | Conversion Time (ms) |
|----------------|----------------------|----------------------|
| 0 | Local Temperature | 12 |
| 1 | Remote 1 Temperature | 38 |
| 2 | Remote 2 Temperature | 38 |

Temperature Measurement Method

A simple method for measuring temperature is to exploit the negative temperature coefficient of a diode by measuring the base-emitter voltage (V_{BE}) of a transistor operated at constant current. Unfortunately, this technique requires calibration to null the effect of the absolute value of V_{BE} , which varies from device to device.

The technique used in the ADT7488A measures the change in V_{BE} when the device is operated at three different currents.

Figure 15 shows the input signal conditioning used to measure the output of a remote temperature sensor. This figure shows the remote sensor as a substrate transistor, which is provided for temperature monitoring on some microprocessors, but it could also be a discrete transistor. If a discrete transistor is used, the collector is not grounded and should be linked to the base. To prevent ground noise from interfering with the measurement, the more negative terminal of the sensor is not referenced to ground, but is biased above ground by an internal diode at the D1- input. If the sensor is operating in an extremely noisy environment, C1 can be added as a noise filter. Its value should not exceed 1,000 pF.

To measure ΔV_{BE} , the operating current through the sensor is switched between three related currents. Figure 15 shows $N1 \times I$ and $N2 \times I$ as different multiples of the

current I . The currents through the temperature diode are switched between I and $N1 \times I$, giving ΔV_{BE1} , and then between I and $N2 \times I$, giving ΔV_{BE2} . The temperature can then be calculated using the two ΔV_{BE} measurements. This method can also cancel the effect of series resistance on the temperature measurement. The resulting ΔV_{BE} waveforms are passed through a 65 kHz low-pass filter to remove noise and then through a chopper-stabilized amplifier to amplify

and rectify the waveform, producing a dc voltage proportional to ΔV_{BE} . The ADC digitizes this voltage, and a temperature measurement is produced. To reduce the effects of noise, digital filtering is performed by averaging the results of 16 measurement cycles for low conversion rates. Signal conditioning and measurement of the internal temperature sensor is performed in the same manner.

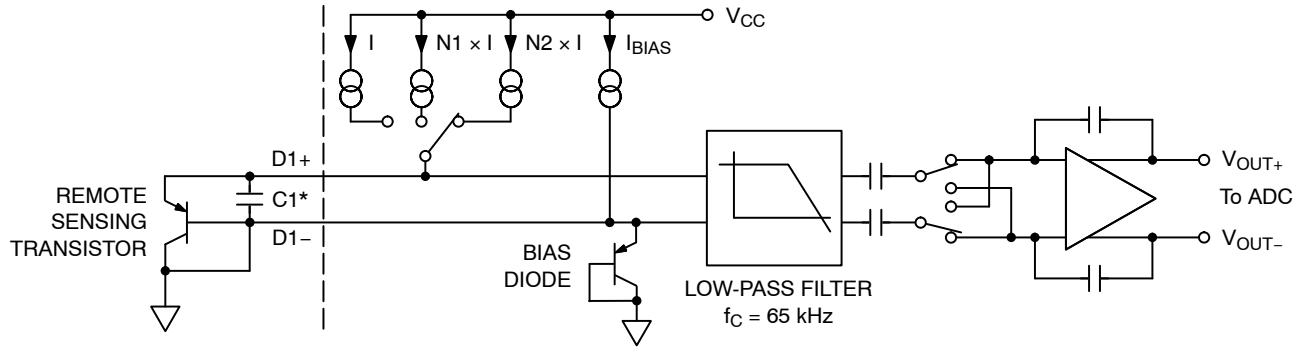

*CAPACITOR C1 IS OPTIONAL. IT SHOULD ONLY BE USED IN NOISY ENVIRONMENTS.

Figure 15. Signal Conditioning for Remote Diode Temperature Sensors

Reading Temperature Measurements

The temperature data returned is two bytes in little endian format, that is, LSB before MSB. All temperatures can be read together by using Command Code 0x00 with a read length of 0x06. The command codes and returned data are described in Table 14.

Table 14. TEMPERATURE CHANNEL COMMAND CODES

| Temp Channel | Command Code | Returned Data |
|--------------|--------------|--|
| Internal | 0x00 | LSB, MSB |
| External 1 | 0x01 | LSB, MSB |
| External 2 | 0x02 | LSB, MSB |
| All Temps | 0x00 | Internal LSB, Internal MSB; External 1 LSB, External 1 MSB, External 2 LSB, External 2 MSB |

SST Temperature Sensor Data Format

The data for temperature is structured to allow values in the range of $\pm 512^{\circ}\text{C}$ to be reported. Thus, the temperature sensor format uses a twos complement, 16-bit binary value to represent values in this range. This format allows temperatures to be represented with approximately a 0.016°C resolution.

Table 15. SST TEMPERATURE DATA FORMAT

| Temperature ($^{\circ}\text{C}$) | Twos Complement | |
|------------------------------------|-----------------|-----------|
| | LSB | MSB |
| -125 | 1110 0000 | 1100 0000 |
| -80 | 1110 1100 | 0000 0000 |
| -40 | 1111 0110 | 0000 0000 |
| -20 | 1111 1011 | 0011 1110 |
| -5 | 1111 1110 | 1100 0000 |
| -1 | 1111 1111 | 1100 0000 |
| 0 | 0000 0000 | 0000 0000 |
| +1 | 0000 0000 | 0100 0000 |
| +5 | 0000 0001 | 0100 0000 |
| +20 | 0000 0100 | 1100 0010 |
| +40 | 0000 1010 | 0000 0000 |
| +80 | 0001 0100 | 0000 0000 |
| +125 | 0001 1111 | 0100 0000 |

Using Discrete Transistors

If a discrete transistor is used, the collector is not grounded and should be linked to the base. If a PNP transistor is used, the base is connected to the D- input and the emitter is

connected to the D+ input. If an NPN transistor is used, the emitter is connected to the D- input and the base is connected to the D+ input.

Figure 16 shows how to connect the ADT7488A to an NPN or PNP transistor for temperature measurement. To prevent ground noise from interfering with the measurement, the more negative terminal of the sensor is not referenced to ground, but is biased above ground by an internal diode at the D- input.

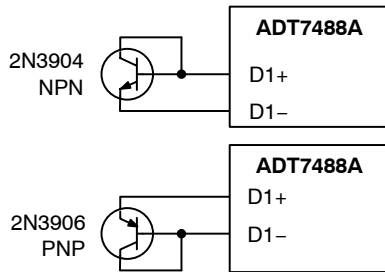

Figure 16. Connections for NPN and PNP Transistors

The ADT7488A shows an external temperature value of 0x8000 if the external diode is an open or short circuit.

Layout Considerations

Digital boards can be electrically noisy environments. Take the following precautions to protect the analog inputs from noise, particularly when measuring the very small voltages from a remote diode sensor:

1. Place the ADT7488A as close as possible to the remote sensing diode. Provided that the worst noise sources, such as clock generators, data/address buses, and CRTs, are avoided, this distance can be four to eight inches.
2. Route the D1+ and D1- tracks close together in parallel with grounded guard tracks on each side. Provide a ground plane under the tracks if possible.
3. Use wide tracks to minimize inductance and reduce noise pickup. A 5 mil track minimum width and spacing is recommended.



Figure 17. Arrangement of Signal Tracks

4. Try to minimize the number of copper/solder joints, which can cause thermocouple effects. Where copper/solder joints are used, make sure that they are in both the D1+ and D1- paths and are at the same temperature.

5. Thermocouple effects should not be a major problem because 1°C corresponds to about 240 μV , and thermocouple voltages are about 3 $\mu\text{V}/^\circ\text{C}$ of the temperature difference. Unless there are two thermocouples with a big temperature differential between them, thermocouple voltages should be much less than 200 mV.
6. Place a 0.1 μF bypass capacitor close to the ADT7488A.
7. If the distance to the remote sensor is more than eight inches, the use of a twisted pair cable is recommended. This works for distances of about 6 feet to 12 feet.
8. For very long distances (up to 100 feet), use shielded twisted pair cables, such as Belden #8451 microphone cables. Connect the twisted pair cable to D+ and D- and the shield to GND, close to the ADT7488A. Leave the remote end of the shield unconnected to avoid ground loops.

Because the measurement technique uses switched current sources, excessive cable and/or filter capacitance can affect the measurement. When using long cables, the filter capacitor can be reduced or removed. Cable resistance can also introduce errors. A 1 Ω series resistance introduces about 0.5°C error.

Temperature Offset

As CPUs run faster, it is more difficult to avoid high frequency clocks when routing the D+ and D- tracks around a system board. Even when the recommended layout guidelines are followed, there may still be temperature errors, attributed to noise being coupled onto the D+ and D- lines. High frequency noise generally has the effect of producing temperature measurements that are consistently too high by a specific amount. The ADT7488A has temperature offset command codes of 0xe0 and 0xe1 through which a desired offset can be set. By doing a one-time calibration of the system, the offset caused by system board noise can be calculated and nulled by specifying it in the ADT7488A. The offset is automatically added to every temperature measurement. The maximum offset is $\pm 128^\circ\text{C}$ with 0.25°C resolution. The offset format is the same as the temperature data format; 16-bit, twos complement notation, as shown in Table 15. The offset should be programmed in little endian format, that is, LSB before MSB. The offset value is also returned in little endian format when read.

Application Schematic

A typical application circuit for the ADT7488A is shown in Figure 18. The ADT7488A can be used in conjunction with the ADP3192 controller to monitor the CPU power. The result is a complete thermal and power monitor for the CPU.

ADT7488A

PACKAGE DIMENSIONS

MSOP-10
CASE 846AC-01
ISSUE O

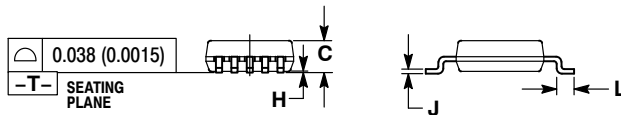
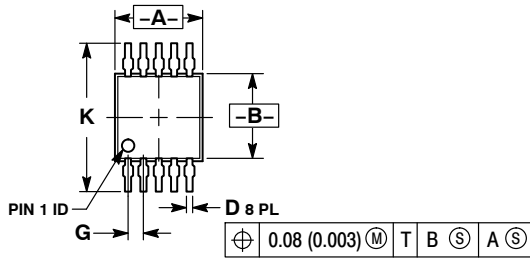

NOTES:

1. DIMENSIONING AND TOLERANCING PER ANSI Y14.5M, 1982.
2. CONTROLLING DIMENSION: MILLIMETER.
3. DIMENSION "A" DOES NOT INCLUDE MOLD FLASH, PROTRUSIONS OR GATE BURRS. MOLD FLASH, PROTRUSIONS OR GATE BURRS SHALL NOT EXCEED 0.15 (0.006) PER SIDE.
4. DIMENSION "B" DOES NOT INCLUDE INTERLEAD FLASH OR PROTRUSION. INTERLEAD FLASH OR PROTRUSION SHALL NOT EXCEED 0.25 (0.010) PER SIDE.
5. 846B-01 OBSOLETE. NEW STANDARD 846B-02

| DIM | MILLIMETERS | | INCHES | |
|-----|-------------|------|-----------|-------|
| | MIN | MAX | MIN | MAX |
| A | 2.90 | 3.10 | 0.114 | 0.122 |
| B | 2.90 | 3.10 | 0.114 | 0.122 |
| C | 0.95 | 1.10 | 0.037 | 0.043 |
| D | 0.20 | 0.30 | 0.008 | 0.012 |
| G | 0.50 BSC | | 0.020 BSC | |
| H | 0.05 | 0.15 | 0.002 | 0.006 |
| J | 0.10 | 0.21 | 0.004 | 0.008 |
| K | 4.75 | 5.05 | 0.187 | 0.199 |
| L | 0.40 | 0.70 | 0.016 | 0.028 |

SOLDERING FOOTPRINT*

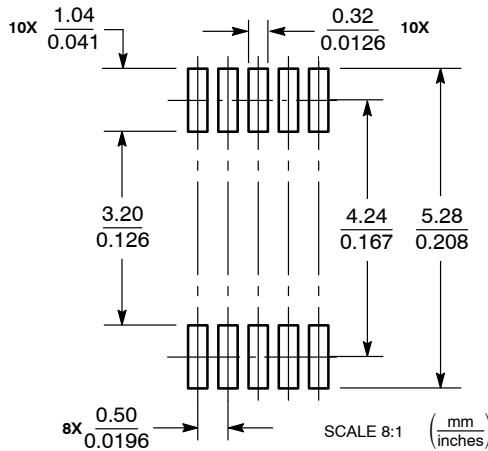

*For additional information on our Pb-Free strategy and soldering details, please download the ON Semiconductor Soldering and Mounting Techniques Reference Manual, SOLDERRM/D.

SST is a licensable bus technology from Analog Devices, Inc., and Intel Corporation.

ON Semiconductor and are registered trademarks of Semiconductor Components Industries, LLC (SCILLC). SCILLC owns the rights to a number of patents, trademarks, copyrights, trade secrets, and other intellectual property. A listing of SCILLC's product/patent coverage may be accessed at www.onsemi.com/site/pdf/Patent-Marking.pdf. SCILLC reserves the right to make changes without further notice to any products herein. SCILLC makes no warranty, representation or guarantee regarding the suitability of its products for any particular purpose, nor does SCILLC assume any liability arising out of the application or use of any product or circuit, and specifically disclaims any and all liability, including without limitation special, consequential or incidental damages. "Typical" parameters which may be provided in SCILLC data sheets and/or specifications can and do vary in different applications and actual performance may vary over time. All operating parameters, including "Typicals" must be validated for each customer application by customer's technical experts. SCILLC does not convey any license under its patent rights nor the rights of others. SCILLC products are not designed, intended, or authorized for use as components in systems intended for surgical implant into the body, or other applications intended to support or sustain life, or for any other application in which the failure of the SCILLC product could create a situation where personal injury or death may occur. Should Buyer purchase or use SCILLC products for any such unintended or unauthorized application, Buyer shall indemnify and hold SCILLC and its officers, employees, subsidiaries, affiliates, and distributors harmless against all claims, costs, damages, and expenses, and reasonable attorney fees arising out of, directly or indirectly, any claim of personal injury or death associated with such unintended or unauthorized use, even if such claim alleges that SCILLC was negligent regarding the design or manufacture of the part. SCILLC is an Equal Opportunity/Affirmative Action Employer. This literature is subject to all applicable copyright laws and is not for resale in any manner.

PUBLICATION ORDERING INFORMATION

LITERATURE FULFILLMENT:
Literature Distribution Center for ON Semiconductor
P.O. Box 5163, Denver, Colorado 80217 USA
Phone: 303-675-2175 or 800-344-3860 Toll Free USA/Canada
Fax: 303-675-2176 or 800-344-3867 Toll Free USA/Canada
Email: orderlit@onsemi.com

N. American Technical Support: 800-282-9855 Toll Free
USA/Canada
Europe, Middle East and Africa Technical Support:
Phone: 421 33 790 2910
Japan Customer Focus Center
Phone: 81-3-5817-1050

ON Semiconductor Website: www.onsemi.com
Order Literature: <http://www.onsemi.com/orderlit>
For additional information, please contact your local Sales Representative

Looking for pricing, stock, or lifecycle information?

Click below to explore more details on WIN SOURCE:

⊖ View [ADT7488AARMZ-REEL7](#) on WIN SOURCE

⊖ [ON Semiconductor](#) Information

Optimize Your Supply Chain with WIN SOURCE Solutions

- ✓ Global Sourcing Solution
- ✓ Obsolete Management
- ✓ Cost Control Management
- ✓ Shortage Management
- ✓ Alternative Solution
- ✓ Excess Inventory Management