



**THE DATASHEET OF  
TLV2462QPWRQ1**



## TLV246xx-Q1 Low-Power Rail-to-Rail Input/Output Operational Amplifiers With Shutdown

### 1 Features

- Qualified for Automotive Applications
- AEC-Q100 Qualified With the Following Results:
  - Device Temperature Grade 1:  $-40^{\circ}\text{C}$  to  $+125^{\circ}\text{C}$  Ambient Operating Temperature Range
  - Device HBM ESD Classification Level 2
  - Device CDM ESD Classification Level C6
- ESD Protection Exceeds 2000 V Per MIL-STD-883, Method 3015; Exceeds 200 V Using Machine Model C = 200 pF, R = 0)
- Rail-to-Rail Output Swing
- Gain Bandwidth Product: 6.4 MHz
- Output Drive Capability:  $\pm 80\text{-mA}$
- Supply Current: 500  $\mu\text{A}/\text{Channel}$
- Input Offset Voltage: 100  $\mu\text{V}$
- Input Noise Voltage: 11  $\text{nV}/\sqrt{\text{Hz}}$
- Slew Rate: 1.6  $\text{V}/\mu\text{s}$
- Micropower Shutdown Mode (TLV2460-Q1/TLV2463-Q1): 0.3  $\mu\text{A}/\text{Channel}$
- Universal Operational Amplifier EVM

### 2 Applications

- Clusters
- Telematics
- HEV/EV and Powertrains
- DC-to-DC Inverters
- Power Steering
- Lighting Modules
- Battery Management Systems

### 3 Description

The devices in the TLV246x-Q1 family of low-power rail-to-rail input/output operational amplifiers are well suited for battery management systems in HEV/EV and Powertrain, and lighting and roof module systems in Body and Lighting applications. The input common-mode voltage range extends beyond the supply rails for maximum dynamic range in low-voltage systems. The amplifier output has rail-to-rail performance with high-output-drive capability, solving one of the limitations of older rail-to-rail input/output operational amplifiers. This rail-to-rail dynamic range and high output drive make the TLV246x-Q1 ideal for buffering analog-to-digital converters.

The operational amplifier has 6.4-MHz bandwidth and a 1.6- $\text{V}/\mu\text{s}$  slew rate with only 500- $\mu\text{A}$  supply current, which provides good ac performance with low-power consumption. Devices are available with an optional shutdown terminal, which places the amplifier in an ultralow supply-current mode ( $I_{\text{DD}} = 0.3 \mu\text{A}/\text{channel}$ ). While in shutdown, the operational amplifier output is placed in a high-impedance state. DC applications are also well served with an input noise voltage of 11  $\text{nV}/\sqrt{\text{Hz}}$  and input offset voltage of 100  $\mu\text{V}$ .

#### Device Information<sup>(1)</sup>

PART NUMBER	PACKAGE	BODY SIZE (NOM)
TLV246x-Q1, TLV246xA-Q1	TSSOP (8)	4.40 mm x 3.00 mm
TLV2462-Q1, TLV2462A-Q1	SOIC (8)	3.91 mm x 4.90 mm
	TSSOP (8)	4.40 mm x 3.00 mm
	VSSOP (8)	3.00 mm x 3.00 mm
TLV246x-Q1, TLV246xA-Q1	TSSOP (14)	4.40 mm x 5.00 mm

(1) For all available packages, see the orderable addendum at the end of the datasheet.

(2) For all available device options, see the [Device Comparison Table](#).

#### Typical Application

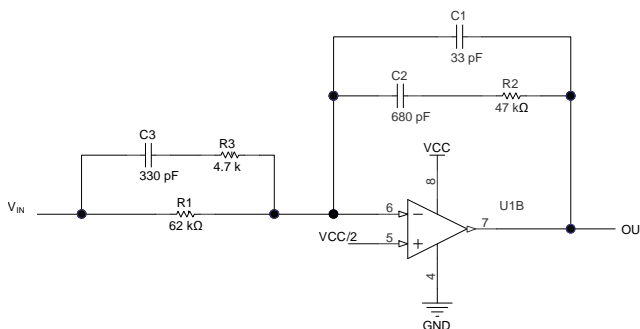

## Table of Contents

<b>1 Features</b> .....	<b>1</b>	9.1 Overview .....	21
<b>2 Applications</b> .....	<b>1</b>	9.2 Functional Block Diagram .....	21
<b>3 Description</b> .....	<b>1</b>	9.3 Feature Description .....	21
<b>4 Revision History</b> .....	<b>2</b>	9.4 Device Functional Modes .....	23
<b>5 Device Comparison Table</b> .....	<b>3</b>	<b>10 Application and Implementation</b> .....	<b>24</b>
<b>6 Pin Configuration and Functions</b> .....	<b>4</b>	10.1 Application Information .....	24
<b>7 Specifications</b> .....	<b>6</b>	10.2 Typical Application .....	26
7.1 Absolute Maximum Ratings .....	6	<b>11 Power Supply Recommendations</b> .....	<b>27</b>
7.2 ESD Ratings .....	6	<b>12 Layout</b> .....	<b>28</b>
7.3 Recommended Operating Conditions .....	6	12.1 Layout Guidelines .....	28
7.4 Thermal Information — 8 Pins .....	7	12.2 Layout Example .....	28
7.5 Thermal Information — 14 pins .....	7	<b>13 Device and Documentation Support</b> .....	<b>29</b>
7.6 Electrical Characteristics - $V_{DD} = 3\text{ V}$ .....	8	13.1 Documentation Support .....	29
7.7 Electrical Characteristics - $V_{DD} = 5\text{ V}$ .....	9	13.2 Related Links .....	29
7.8 Operating Characteristics - $V_{DD} = 3\text{ V}$ .....	10	13.3 Community Resources .....	29
7.9 Operating Characteristics - $V_{DD} = 5\text{ V}$ .....	10	13.4 Trademarks .....	29
7.10 Typical Characteristics .....	12	13.5 Electrostatic Discharge Caution .....	29
<b>8 Parameter Measurement Information</b> .....	<b>21</b>	13.6 Glossary .....	29
<b>9 Detailed Description</b> .....	<b>21</b>	<b>14 Mechanical, Packaging, and Orderable Information</b> .....	<b>30</b>

## 4 Revision History

NOTE: Page numbers for previous revisions may differ from page numbers in the current version.

Changes from Revision E (October 2012) to Revision F	Page
• Added AEC-Q100 bulleted items .....	1
• Added <i>ESD Ratings</i> table, <i>Feature Description</i> section, <i>Device Functional Modes</i> , <i>Application and Implementation</i> section, <i>Power Supply Recommendations</i> section, <i>Layout</i> section, <i>Device and Documentation Support</i> section, and <i>Mechanical, Packaging, and Orderable Information</i> section .....	1
• Changed TLV2464AQDRQ1 Product Preview to Active .....	3
• Deleted TLV2464-Q1 part numbers in <i>Device Comparison Table</i> and Product Preview note .....	3
• Deleted D package from TLV2460-Q1, TLV2461-Q1, TLV2463-Q1, and TLV2464A-Q1 and added TLV246xA-Q1 device number to pin drawings .....	4
• Deleted table note 3 reference to JESD 51-5 from <i>Absolute Maximum Ratings</i> table .....	6

Changes from Revision D (September 2010) to Revision E	Page
• Changed device names from TLV246xx to TLV246xx-Q1 throughout document .....	1
• Removed package column from ordering information table .....	3
• Changed $I_{DD}$ unit from $\mu\text{A}$ to mA. ....	8
• Changed $I_{DD}$ unit from $\mu\text{A}$ to mA .....	9

## 5 Device Comparison Table

$V_{IOmax}$ at 25°C	PART NUMBER <sup>(1)</sup>
2000 $\mu$ V	TLV2462QDRQ1
	TLV2460QPWRQ1
	TLV2461QPWRQ1
	TLV2462QPWRQ1
	TLV2463QPWRQ1
	TLV2462QDGKRQ1
1500 $\mu$ V	TLV2462AQDRQ1
	TLV2460AQPWRQ1
	TLV2461AQPWRQ1
	TLV2462AQPWRQ1
	TLV2463AQPWRQ1
	TLV2464AQPWRQ1

(1) Package drawings, thermal data, and symbolization are available at [www.ti.com/packaging](http://www.ti.com/packaging).

## 6 Pin Configuration and Functions

TLV2460-Q1, TLV2460A-Q1 PW Package  
 8-Pin TSSOP  
 Top View

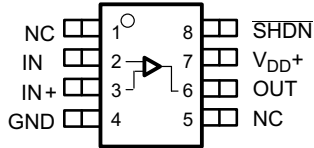

TLV2461-Q1, TLV2461A-Q1 PW Package  
 8-Pin TSSOP  
 Top View

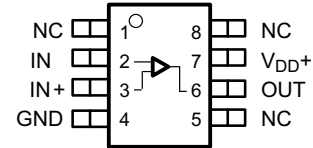

TLV2462-Q1, TLV2462A-Q1 D, DGK, or PW Package  
 8-Pin SOIC, TSSOP, or VSSOP  
 Top View

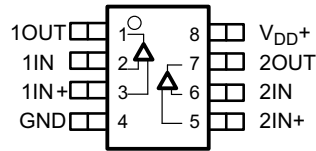

NC – No internal connection

### 8-Pin Functions

NAME	PIN			I/O	DESCRIPTION
	TLV2460-Q1, TLV2460A-Q1	TLV2461-Q1, TLV2461A-Q1	TLV2462-Q1, TLV2462A-Q1		
1IN	—	—	2	I	Inverting input, channel 1
1IN+	—	—	3	I	Noninverting input, channel 1
1OUT	—	—	1	O	Output, channel 1
2IN	—	—	6	I	Inverting input, channel 2
2IN+	—	—	5	I	Noninverting input, channel 2
2OUT	—	—	7	O	Output, channel 2
IN	2	2	—	I	Inverting input
IN+	3	3	—	I	Noninverting input
GND	4	4	4	—	Negative (lowest) supply
NC	1, 5	1, 5, 8	—	—	No internal connection
OUT	6	6	—	O	Output
SHDN	8	—	—	I	Shutdown
V <sub>DD+</sub>	7	7	8	—	Positive (highest) supply

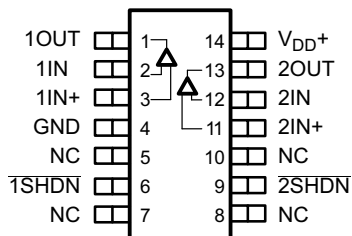
**TLV2463-Q1, TLV2463A-Q1 PW Package  
14-Pin TSSOP  
Top View**

NC – No internal connection

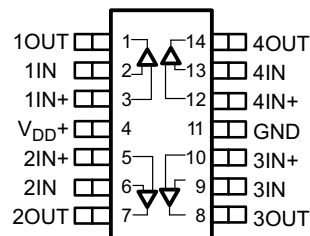
**TLV2463-Q1, TLV2463A-Q1 PW Package  
14-Pin TSSOP  
Top View**

**14-Pin Functions**

NAME	PIN		I/O	DESCRIPTION
	TLV2463-Q1, TLV2463A-Q1	TLV2464A-Q1		
1IN	2	2	I	Inverting input, channel 1
1IN+	3	3	I	Noninverting input, channel 1
1OUT	1	1	O	Output, channel 1
1SHDN	6	—	I	Shutdown for channel 1
2IN	12	6	I	Inverting input, channel 2
2IN+	11	5	I	Noninverting input, channel 2
2OUT	13	7	O	Output, channel 2
2SHDN	9	—	I	Shutdown for channel 2
3IN	—	9	I	Inverting input, channel 3
3IN+	—	10	I	Noninverting input, channel 3
3OUT	—	8	O	Output, channel 3
4IN	—	13	I	Inverting input, channel 4
4IN+	—	12	I	Noninverting input, channel 4
4OUT	—	14	O	Output, channel 4
IN	—	—	I	Inverting input
IN+	—	—	I	Noninverting input
GND	4	11	—	Negative (lowest) supply
NC	5, 7, 8, 10	—	—	No internal connection
OUT	—	—	O	Output
SHDN	—	—	I	Shutdown
V <sub>DD+</sub>	14	4	—	Positive (highest) supply

## 7 Specifications

### 7.1 Absolute Maximum Ratings

over operating free-air temperature range (unless otherwise noted) <sup>(1)</sup>

		MIN	MAX	UNIT
V <sub>DD</sub>	Supply voltage <sup>(2)</sup>		6	V
V <sub>ID</sub>	Differential input voltage range	-0.2 V	V <sub>DD</sub> + 0.2 V	V
I <sub>I</sub>	Input current (any input)	-200	200	mA
I <sub>O</sub>	Output current	-175	175	mA
I <sub>I</sub>	Total input current (into V <sub>DD+</sub> )		175	mA
I <sub>O</sub>	Total output current (out of GND)		175	mA
T <sub>A</sub>	Operating free-air temperature range	-40	125	°C
T <sub>J</sub>	Maximum junction temperature		150	°C
	Lead temperature 1,6 mm (1/16 inch) from case for 10 seconds		260	°C
	Storage temperature, T <sub>stg</sub>	-65	150	°C

(1) Stresses beyond those listed under *Absolute Maximum Ratings* may cause permanent damage to the device. These are stress ratings only, which do not imply functional operation of the device at these or any other conditions beyond those indicated under *Recommended Operating Conditions*. Exposure to absolute-maximum-rated conditions for extended periods may affect device reliability.

(2) All voltage values, except differential voltages, are with respect to GND.

### 7.2 ESD Ratings

		VALUE	UNIT
V <sub>(ESD)</sub>	Electrostatic discharge	Human-body model (HBM), per AEC Q100-002 <sup>(1)</sup>	±2000
		Charged-device model (CDM), per AEC Q100-011	±1000

(1) AEC Q100-002 indicates that HBM stressing shall be in accordance with the ANSI/ESDA/JEDEC JS-001 specification.

### 7.3 Recommended Operating Conditions

		MIN	NOM	MAX	UNIT
V <sub>DD</sub>	Supply voltage	Single supply	2.7	6	V
		Split supply	±1.35	±3	
V <sub>ICR</sub>	Common-mode input voltage range	-0.2		V <sub>DD</sub> + 0.2	V
T <sub>A</sub>	Operating free-air temperature	-40		125	°C
	Shutdown on/off voltage level <sup>(1)</sup>	V <sub>IH</sub>	2		V
		V <sub>IL</sub>		0.7	

(1) Relative to voltage on the GND terminal of the device

## 7.4 Thermal Information — 8 Pins

THERMAL METRIC <sup>(1)</sup>		TLV2462-Q1, TLV2462A-Q1	TLV2461-Q1	TLV2460-Q1, TLV2462-Q1, TLV246[0-2]A-Q1	TLV2462-Q1	UNIT
		D (SOIC)	PW (TSSOP)		DGK (VSSOP)	
		8 PINS	8 PINS		8 PINS	
$R_{\theta JA}$	Junction-to-ambient thermal resistance	120.1	183.6	185.7	179.3	°C/W
$R_{\theta JC(top)}$	Junction-to-case (top) thermal resistance	68.3	67	69	71.1	°C/W
$R_{\theta JB}$	Junction-to-board thermal resistance	60.4	112.3	114.5	100.4	°C/W
$\Psi_{JT}$	Junction-to-top characterization parameter	20.6	9	9.6	10.7	°C/W
$\Psi_{JB}$	Junction-to-board characterization parameter	59.9	110.6	112.7	98.8	°C/W
$R_{\theta JC(bot)}$	Junction-to-case (bottom) thermal resistance	N/A	N/A	N/A	N/A	°C/W

(1) For more information about traditional and new thermal metrics, see the *Semiconductor and IC Package Thermal Metrics* application report, [SPRA953](#).

## 7.5 Thermal Information — 14 pins

THERMAL METRIC <sup>(1)</sup>		TLV2463-Q1, TLV246[3-4]A-Q1	UNIT
		PW (TSSOP)	
		14 PINS	
$R_{\theta JA}$	Junction-to-ambient thermal resistance	119.1	°C/W
$R_{\theta JC(top)}$	Junction-to-case (top) thermal resistance	47.9	°C/W
$R_{\theta JB}$	Junction-to-board thermal resistance	60.8	°C/W
$\Psi_{JT}$	Junction-to-top characterization parameter	5.4	°C/W
$\Psi_{JB}$	Junction-to-board characterization parameter	60.2	°C/W
$R_{\theta JC(bot)}$	Junction-to-case (bottom) thermal resistance	N/A	°C/W

(1) For more information about traditional and new thermal metrics, see the *Semiconductor and IC Package Thermal Metrics* application report, [SPRA953](#).

## 7.6 Electrical Characteristics - $V_{DD} = 3\text{ V}$

at specified free-air temperature,  $V_{DD} = 3\text{ V}$  (unless otherwise noted)

PARAMETER		TEST CONDITIONS		$T_A$ <sup>(1)</sup>	MIN	TYP	MAX	UNIT
$V_{IO}$	Input offset voltage	$V_{DD} = 3\text{ V}$ , $V_{IC} = 1.5\text{ V}$ , $V_O = 1.5\text{ V}$ , $R_S = 50\ \Omega$	TLV246x-Q1	25°C		100	2000	$\mu\text{V}$
				Full range			2200	
			TLV246xA-Q1	25°C		150	1500	
				Full range			1700	
$\alpha_{VIO}$	Temperature coefficient of input offset voltage	$V_{DD} = 3\text{ V}$ , $V_{IC} = 1.5\text{ V}$ , $V_O = 1.5\text{ V}$ , $R_S = 50\ \Omega$				2		$\mu\text{V}/^\circ\text{C}$
$I_{IO}$	Input offset current	$V_{DD} = 3\text{ V}$ , $V_{IC} = 1.5\text{ V}$ , $V_O = 1.5\text{ V}$ , $R_S = 50\ \Omega$		25°C		2.8	7	$\text{pA}$
				Full range			75	
$I_{IB}$	Input bias current	$V_{IC} = 1.5\text{ V}$ , $V_O = 1.5\text{ V}$ , $R_S = 50\ \Omega$		25°C		4.4	14	$\text{pA}$
				Full range			75	
$V_{OH}$	High-level output voltage	$I_O = -2.5\text{ mA}$		25°C		2.9		$\text{V}$
				Full range		2.8		
				25°C		2.7		
				Full range		2.5		
$V_{OL}$	Low-level output voltage	$V_{IC} = 1.5\text{ V}$ , $I_{OL} = 2.5\text{ mA}$		25°C		0.1		$\text{V}$
				Full range			0.2	
				25°C		0.3		
				Full range			0.5	
$I_{OS}$	Short circuit output current		Sourcing	25°C		50		$\text{mA}$
				Full range		20		
			Sinking	25°C		40		
				Full range		20		
$I_O$	Output current	Measured 1 V from rail		25°C		$\pm 40$		$\text{mA}$
$A_{VD}$	Large-signal differential voltage amplification	$R_L = 10\text{ k}\Omega$		25°C		90	105	$\text{dB}$
				Full range		89		
$r_{i(d)}$	Differential input resistance			25°C		$10^9$		$\Omega$
$C_{i(o)}$	Common-mode input capacitance	$f = 10\text{ kHz}$		25°C		7		$\text{pF}$
$z_o$	Closed-loop output impedance	$f = 100\text{ kHz}$ , $A_V = 10$		25°C		33		$\Omega$
CMRR	Common-mode rejection ratio	$V_{ICR} = 0\text{ V to } 3\text{ V}$ , $R_S = 50\ \Omega$		25°C		66	80	$\text{dB}$
				Full range		60		
$k_{SVR}$	Supply-voltage rejection ratio ( $\Delta V_{DD\pm}/\Delta V_{IO}$ )	$V_{DD} = 2.7\text{ V to } 6\text{ V}$ , $V_{IC} = V_{DD}/2$ , No load		25°C		80	85	$\text{dB}$
				Full range		75		
		$V_{DD} = 3\text{ V to } 5\text{ V}$ , $V_{IC} = V_{DD}/2$ , No load		25°C		85	95	
				Full range		80		
$I_{DD}$	Supply current (per channel)	$V_O = 1.5\text{ V}$ , No load		25°C		0.5	0.575	$\text{mA}$
				Full range			0.9	
$I_{DD(\text{SHDN})}$	Supply current in shutdown (TLV2460-Q1, TLV2463-Q1)	$\overline{\text{SHDN}} < 0.7\text{ V}$ , Per channel in shutdown		25°C		0.3		$\mu\text{A}$
				Full range			2.5	

(1) Full range is  $-40^\circ\text{C}$  to  $125^\circ\text{C}$ .

## 7.7 Electrical Characteristics - $V_{DD} = 5\text{ V}$

 at specified free-air temperature,  $V_{DD} = 5\text{ V}$  (unless otherwise noted)

PARAMETER		TEST CONDITIONS		$T_A$ <sup>(1)</sup>	MIN	TYP	MAX	UNIT
$V_{IO}$	Input offset voltage	$V_{DD} = 5\text{ V}$ , $V_{IC} = 2.5\text{ V}$ , $V_O = 2.5\text{ V}$ , $R_S = 50\ \Omega$	TLV246x-Q1	25°C		150	2000	$\mu\text{V}$
				Full range			2200	
			TLV246xA-Q1	25°C		150	1500	
				Full range			1700	
$\alpha_{VIO}$	Temperature coefficient of input offset voltage	$V_{DD} = 5\text{ V}$ , $V_{IC} = 2.5\text{ V}$ , $V_O = 2.5\text{ V}$ , $R_S = 50\ \Omega$			2		$\mu\text{V}/^\circ\text{C}$	
$I_{IO}$	Input offset current	$V_{DD} = 5\text{ V}$ , $V_{IC} = 2.5\text{ V}$ , $V_O = 2.5\text{ V}$ , $R_S = 50\ \Omega$	25°C		0.3	7	$\text{pA}$	
			Full range			60		
$I_{IB}$	Input bias current	$V_{DD} = 5\text{ V}$ , $V_{IC} = 2.5\text{ V}$ , $V_O = 2.5\text{ V}$ , $R_S = 50\ \Omega$	25°C		1.3	14	$\text{pA}$	
			Full range			60		
$V_{OH}$	High-level output voltage	$I_O = -2.5\text{ mA}$	TLV246x-Q1, TLV246xA-Q1	25°C		4.9	$\text{V}$	
				Full range		4.8		
			TLV2462QDGKRQ1	25°C		4.8		
				Full range		4.7		
			$I_O = -10\text{ mA}$	25°C		4.8		
				Full range		4.4		
$V_{OL}$	Low-level output voltage	$V_{IC} = 2.5\text{ V}$ , $I_{OL} = 2.5\text{ mA}$	25°C		0.1	$\text{V}$		
			Full range				0.2	
			$V_{IC} = 2.5\text{ V}$ , $I_{OL} = 10\text{ mA}$	25°C			0.2	
			Full range				0.3	
$I_{OS}$	Short circuit output current		Sourcing	25°C		145	$\text{mA}$	
				Full range		60		
			Sinking	25°C		100		
				Full range		60		
$I_O$	Output current	Measured 1 V from rail	25°C		$\pm 80$	$\text{mA}$		
$A_{VD}$	Large-signal differential voltage amplification	$V_{IC} = 2.5\text{ V}$ , $R_L = 10\text{ k}\Omega$ , $V_O = 1\text{ V to }4\text{ V}$	25°C		92	109	$\text{dB}$	
			Full range		90			
$r_{i(d)}$	Differential input resistance		25°C		$10^9$	$\Omega$		
$C_{i(o)}$	Common-mode input capacitance	$f = 10\text{ kHz}$	25°C		7	$\text{pF}$		
$Z_o$	Closed-loop output impedance	$f = 100\text{ kHz}$ , $A_V = 10$	25°C		29	$\Omega$		
CMRR	Common-mode rejection ratio	$V_{ICR} = 0\text{ V to }5\text{ V}$ , $R_S = 50\ \Omega$	25°C		71	85	$\text{dB}$	
			Full range		60			
$k_{SVR}$	Supply-voltage rejection ratio ( $\Delta V_{DD\pm}/\Delta V_{IO}$ )	$V_{DD} = 2.7\text{ V to }6\text{ V}$ , $V_{IC} = V_{DD}/2$ , No load	25°C		80	85	$\text{dB}$	
			Full range		75			
		$V_{DD} = 3\text{ V to }5\text{ V}$ , $V_{IC} = V_{DD}/2$ , No load	25°C		85	95		
			Full range		80			
$I_{DD}$	Supply current (per channel)	$V_O = 2.5\text{ V}$ , No load	25°C		0.55	0.65	$\text{mA}$	
			Full range			1		
$I_{DD(SHD)}$ <small>N)</small>	Supply current in shutdown (TLV2460-Q1, TLV2463-Q1)	$\overline{\text{SHDN}} < 0.7\text{ V}$ , Per channel in shutdown	25°C		1		$\mu\text{A}$	
			Full range			3		

 (1) Full range is  $-40^\circ\text{C}$  to  $125^\circ\text{C}$ .

## 7.8 Operating Characteristics - $V_{DD} = 3\text{ V}$

$V_{DD} = 3\text{ V}$ , at specified free-air temperature (unless otherwise noted)

PARAMETER		TEST CONDITIONS		$T_A$ (1)	MIN	TYP	MAX	UNIT	
SR	Slew rate at unity gain	$V_{O(PP)} = 2\text{ V}$ , $C_L = 160\text{ pF}$ , $R_L = 10\text{ k}\Omega$		25°C	1	1.6		V/ $\mu\text{s}$	
				Full range	0.8				
$V_n$	Equivalent input noise voltage	$f = 100\text{ Hz}$ $f = 1\text{ kHz}$		25°C	16			nV/ $\sqrt{\text{Hz}}$	
					11				
$I_n$	Equivalent input noise current	$f = 1\text{ kHz}$		25°C	0.13		pA/ $\sqrt{\text{Hz}}$		
THD+N	Total harmonic distortion plus noise	$V_{O(PP)} = 2\text{ V}$ , $R_L = 10\text{ k}\Omega$ , $f = 1\text{ kHz}$		25°C	$A_V = 1$	0.006%			
					$A_V = 10$	0.02%			
					$A_V = 100$	0.08%			
$t_{(on)}$	Amplifier turn-on time	$A_V = 1$ , $R_L = 10\text{ k}\Omega$		25°C	Both channels	7.6		$\mu\text{s}$	
					Channel 1 only, Channel 2 on	7.65			
$t_{(off)}$	Amplifier turn-off time	$A_V = 1$ , $R_L = 10\text{ k}\Omega$		25°C	Both channels	333		ns	
					Channel 1 only, Channel 2 on	328			
					Channel 2 only, Channel 1 on	329			
Gain-bandwidth product		$f = 10\text{ kHz}$ , $C_L = 160\text{ pF}$ , $R_L = 10\text{ k}\Omega$		25°C	5.2		MHz		
$t_s$	Settling time	$V_{(STEP)PP} = 2\text{ V}$ , $A_V = -1$ , $C_L = 10\text{ pF}$ , $R_L = 10\text{ k}\Omega$		25°C	0.1%	1.47		$\mu\text{s}$	
					0.01%	1.78			
					$V_{(STEP)PP} = 2\text{ V}$ , $A_V = -1$ , $C_L = 56\text{ pF}$ , $R_L = 10\text{ k}\Omega$	0.1%	1.77		
					0.01%	1.98			
$\Phi_m$	Phase margin at unity gain	$R_L = 10\text{ k}\Omega$ , $C_L = 160\text{ pF}$		25°C	44		°		
Gain margin		$R_L = 10\text{ k}\Omega$ , $C_L = 160\text{ pF}$		25°C	7		dB		

(1) Full range is  $-40^\circ\text{C}$  to  $125^\circ\text{C}$ .

## 7.9 Operating Characteristics - $V_{DD} = 5\text{ V}$

$V_{DD} = 5\text{ V}$ , at specified free-air temperature (unless otherwise noted)

PARAMETER		TEST CONDITIONS		$T_A$ (1)	MIN	TYP	MAX	UNIT
SR	Slew rate at unity gain	$V_{O(PP)} = 2\text{ V}$ , $C_L = 160\text{ pF}$ , $R_L = 10\text{ k}\Omega$		25°C	1	1.6		V/ $\mu\text{s}$
				Full range	0.8			
$V_n$	Equivalent input noise voltage	$f = 100\text{ Hz}$ $f = 1\text{ kHz}$		25°C	14			nV/ $\sqrt{\text{Hz}}$
					11			
$I_n$	Equivalent input noise current	$f = 100\text{ Hz}$		25°C	0.13		pA/ $\sqrt{\text{Hz}}$	
THD+N	Total harmonic distortion plus noise	$V_{O(PP)} = 4\text{ V}$ , $R_L = 10\text{ k}\Omega$ , $f = 10\text{ kHz}$		25°C	$A_V = 1$	0.004%		
					$A_V = 10$	0.01%		
					$A_V = 100$	0.04%		
$t_{(on)}$	Amplifier turn-on time	$A_V = 1$ , $R_L = 10\text{ k}\Omega$		25°C	Both channels	7.6		$\mu\text{s}$
					Channel 1 only, Channel 2 on	7.65		
					Channel 2 only, Channel 1 on	7.25		

(1) Full range is  $-40^\circ\text{C}$  to  $125^\circ\text{C}$ .

**Operating Characteristics -  $V_{DD} = 5\text{ V}$  (continued)**
 $V_{DD} = 5\text{ V}$ , at specified free-air temperature (unless otherwise noted)

PARAMETER		TEST CONDITIONS		$T_A$ <sup>(1)</sup>	MIN	TYP	MAX	UNIT	
$t_{\text{off}}$	Amplifier turn-off time	$A_V = 1$ , $R_L = 10\text{ k}\Omega$	Both channels	25°C	333			ns	
			Channel 1 only, Channel 2 on		328				
			Channel 2 only, Channel 1 on		329				
Gain-bandwidth product		$f = 10\text{ kHz}$ , $C_L = 160\text{ pF}$ , $R_L = 10\text{ k}\Omega$		25°C	6.4			MHz	
$t_s$	Settling time	$V_{\text{(STEP)PP}} = 2\text{ V}$ , $A_V = -1$ , $C_L = 10\text{ pF}$ , $R_L = 10\text{ k}\Omega$	0.1%	25°C	1.53			$\mu\text{s}$	
			0.01%		1.83				
			$V_{\text{(STEP)PP}} = 2\text{ V}$ , $A_V = -1$ , $C_L = 56\text{ pF}$ , $R_L = 10\text{ k}\Omega$		0.1%	3.13			
			0.01%		3.33				
$\phi_m$	Phase margin at unity gain	$R_L = 10\text{ k}\Omega$ , $C_L = 160\text{ pF}$		25°C	45			°	
Gain margin		$R_L = 10\text{ k}\Omega$ , $C_L = 160\text{ pF}$		25°C	7			dB	

## 7.10 Typical Characteristics

**Table 1. Table of Graphs**

			<b>FIGURE</b>
$V_{IO}$	Input offset voltage	vs Common-mode input voltage	1, 2
$I_{IB}$	Input bias current	vs Free-air temperature	3, 4
$I_{IO}$	Input offset current	vs Free-air temperature	3, 4
$V_{OH}$	High-level output voltage	vs High-level output current	5, 6
$V_{OL}$	Low-level output voltage	vs Low-level output current	7, 8
$V_{O(PP)}$	Maximum peak-to-peak output voltage	vs Frequency	9, 10
	Open-loop gain	vs Frequency	11, 12
	Phase	vs Frequency	11, 12
$A_{VD}$	Differential voltage amplification	vs Load resistance	13
	Capacitive load	vs Load resistance	14
$z_o$	Output impedance	vs Frequency	15, 16
CMRR	Common-mode rejection ratio	vs Frequency	17
$k_{SVR}$	Supply-voltage rejection ratio	vs Frequency	18, 19
$I_{DD}$	Supply current	vs Supply voltage	20
		vs Free-air temperature	21
	Amplifier turnon characteristics		22
	Amplifier turnoff characteristics		23
	Supply current turnon		24
	Supply current turnoff		25
	Shutdown supply current	vs Free-air temperature	26
SR	Slew rate	vs Load capacitance	27
$V_n$	Equivalent input noise voltage	vs Frequency	28, 29
		vs Common-mode input voltage	30, 31
THD	Total harmonic distortion	vs Frequency	32, 33
THD + N	Total harmonic distortion plus noise	vs Peak-to-peak signal amplitude	34, 35
$\Phi_m$	Phase margin	vs Frequency	11, 12
		vs Load capacitance	36
		vs Free-air temperature	37
	Gain-bandwidth product	vs Supply voltage	38
		vs Free-air temperature	39
	Large signal follower		40, 41
	Small signal follower		42, 43
	Inverting large signal		44, 45
	Inverting small signal		46, 47

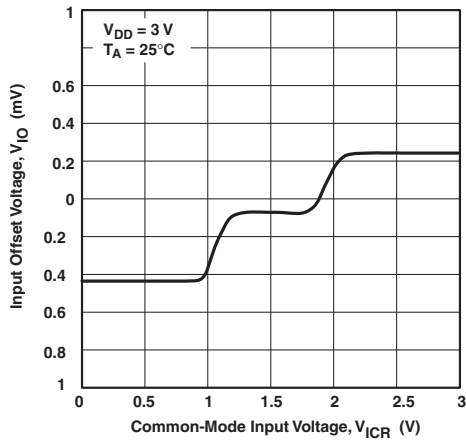

Figure 1. Input Offset Voltage vs Common-Mode Input Voltage,  $V_{DD} = 3\text{ V}$

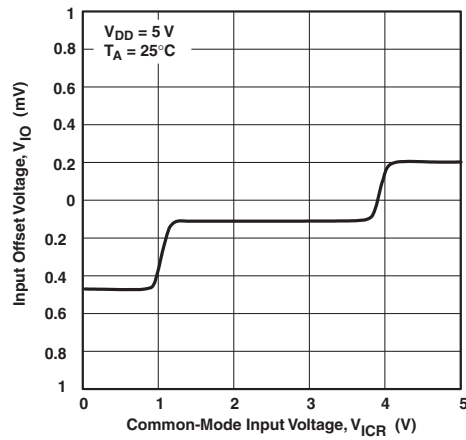

Figure 2. Input Offset Voltage vs Common-Mode Input Voltage,  $V_{DD} = 5\text{ V}$

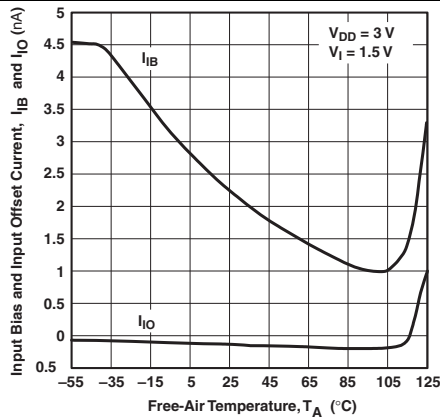

Figure 3. Input Bias and Input Offset Current vs Free-Air Temperature,  $V_{DD} = 3\text{ V}$

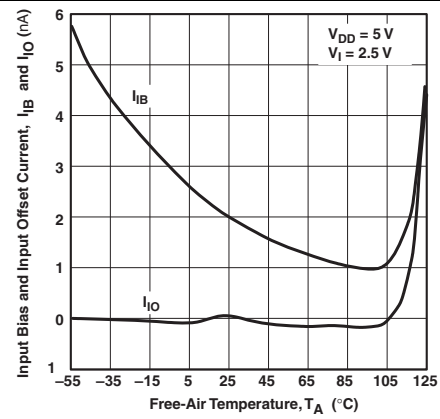

Figure 4. Input Bias and Input Offset Current vs Free-Air Temperature,  $V_{DD} = 5\text{ V}$

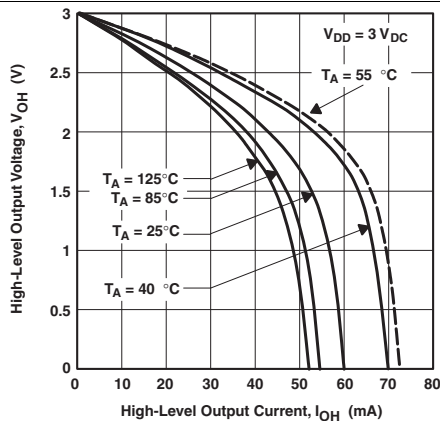

Figure 5. High-level Output Voltage vs High-Level Output Current,  $V_{DD} = 3\text{ V}_{DC}$

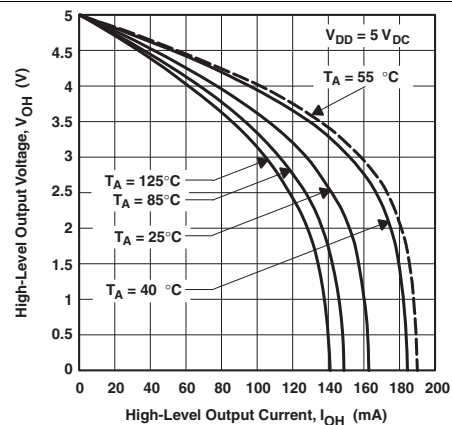

Figure 6. High-level Output Voltage vs High-Level Output Current,  $V_{DD} = 5\text{ V}_{DC}$

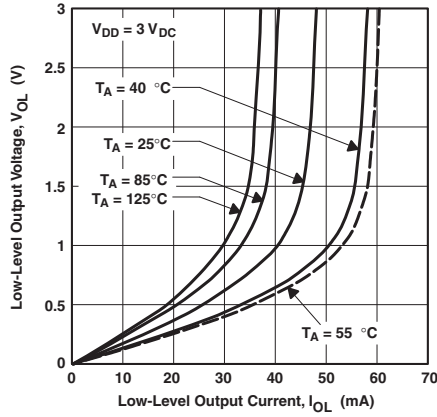

Figure 7. Low-Level Output Voltage vs Low-Level Output Current,  $V_{DD} = 3 V_{DC}$

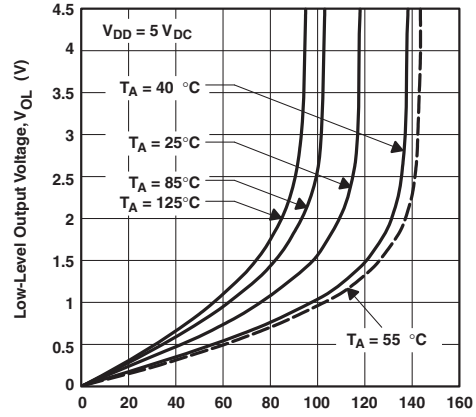

Figure 8. Low-level Output Voltage vs Low-level Output Current,  $V_{DD} = 5 V_{DC}$

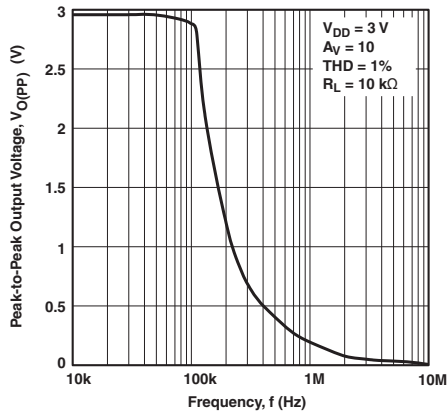

Figure 9. Peak-to-Peak Output Voltage vs Frequency,  $V_{DD} = 3 V$

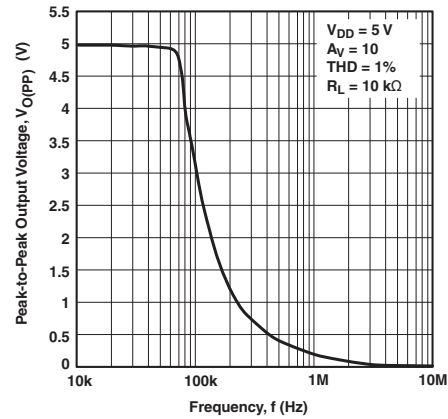

Figure 10. Peak-to-Peak Output Voltage vs Frequency,  $V_{DD} = 5 V$

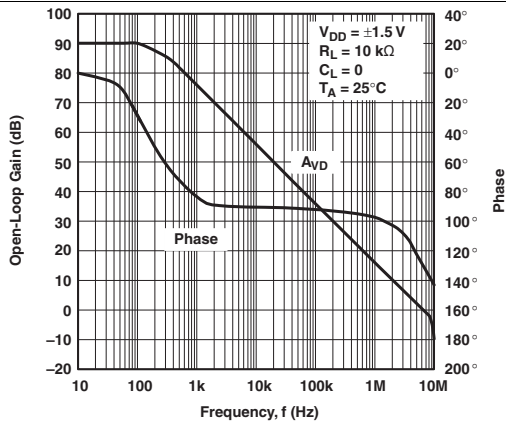

Figure 11. Open-Loop Gain and Phase vs Frequency,  $V_{DD} = \pm 1.5 V$

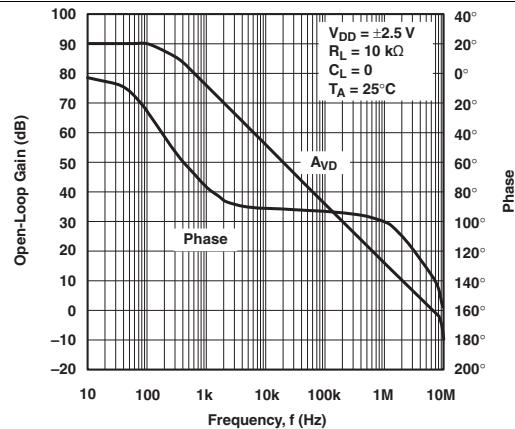

Figure 12. Open-Loop Gain and Phase vs Frequency,  $V_{DD} = \pm 2.5 V$

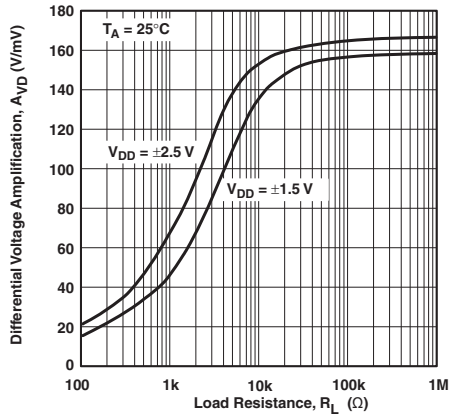

Figure 13. Differential Voltage Amplification vs Load Resistance

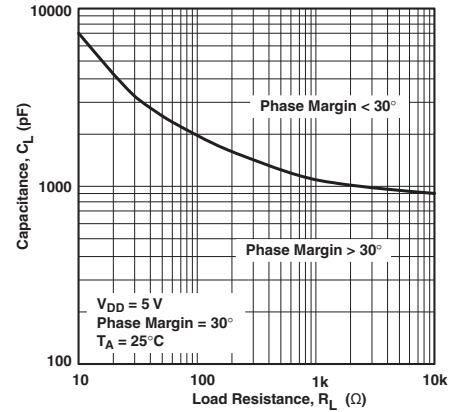

Figure 14. Capacitive Load vs Load Resistance

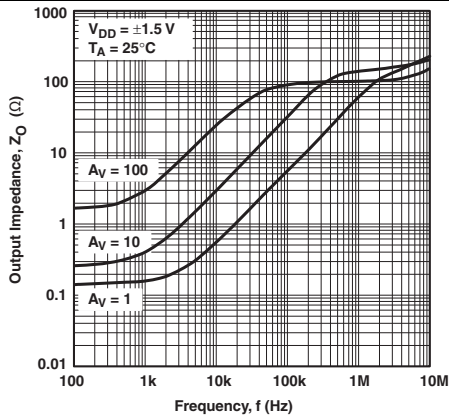

Figure 15. Output Impedance vs Frequency,  $V_{DD} = \pm 1.5 V$

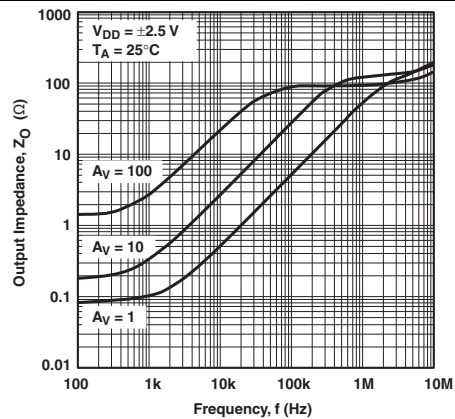

Figure 16. Output Impedance vs Frequency,  $V_{DD} = \pm 2.5 V$

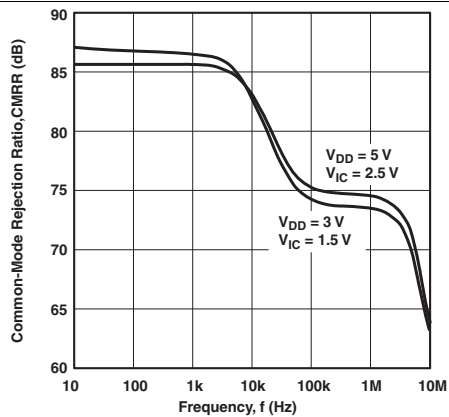

Figure 17. Common-Mode Rejection Ratio vs Frequency

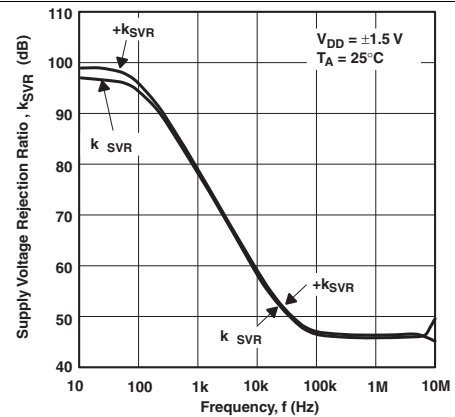

Figure 18. Supply-Voltage Rejection Ratio vs Frequency,  $V_{DD} = \pm 1.5 V$

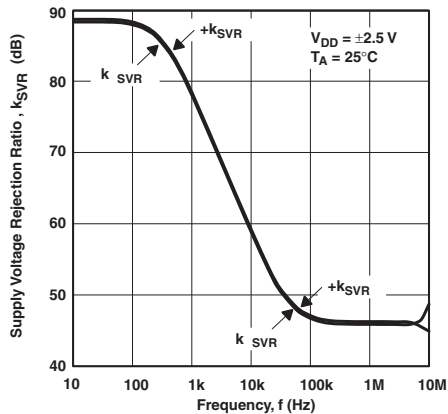

Figure 19. Supply-Voltage Rejection Ratio vs Frequency,  $V_{DD} = \pm 2.5\text{ V}$

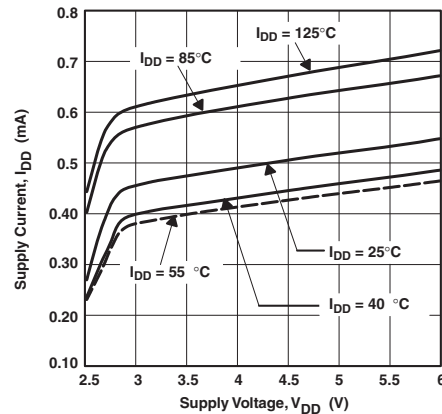

Figure 20. Supply Current vs Supply Voltage

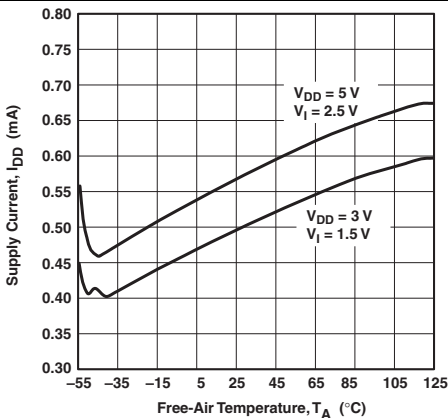

Figure 21. Supply Current vs Free-Air Temperature

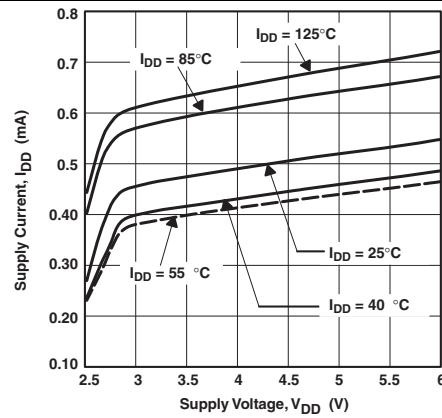

Figure 22. Amplifier With a Shutdown Pulse Turnon Characteristics

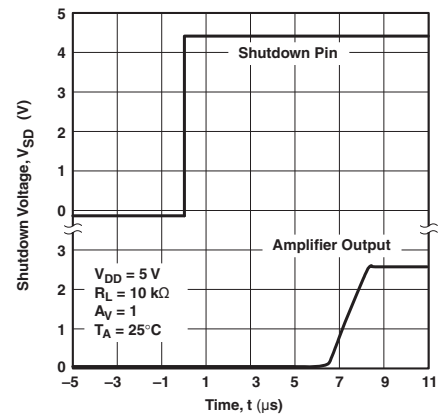

Figure 23. Amplifier With a Shutdown Pulse Turnoff Characteristics

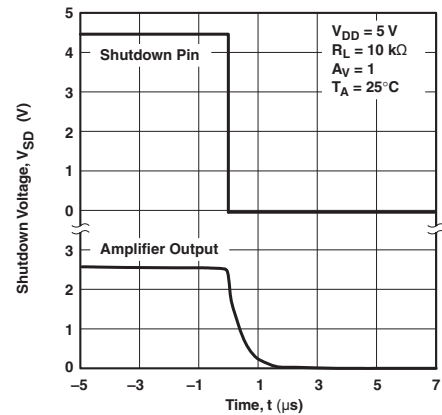

Figure 24. Supply Current With a Shutdown Pulse Turnon Characteristics

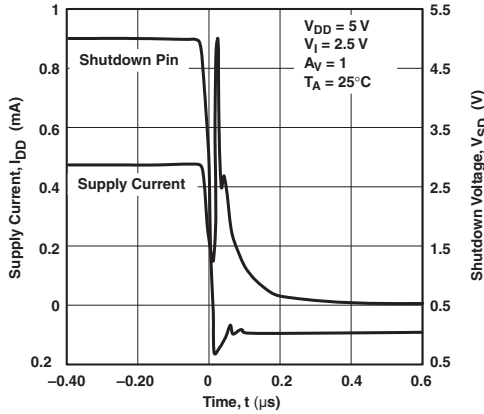

Figure 25. Turnoff Supply Current With a Shutdown Pulse

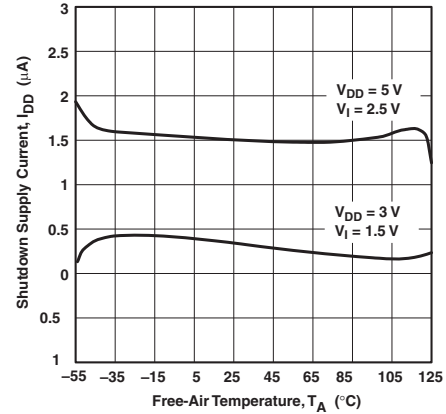

Figure 26. Shutdown Supply Current vs Free-Air Temperature

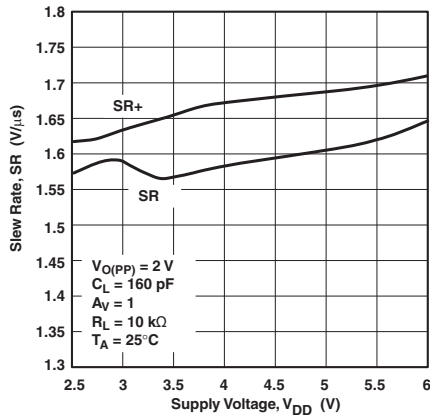

Figure 27. Slew Rate vs Supply Voltage

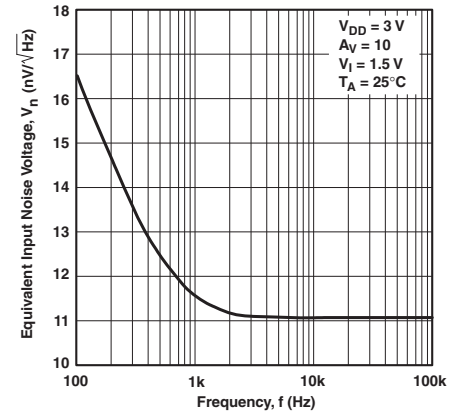

Figure 28. Equivalent Input Noise Voltage vs Frequency

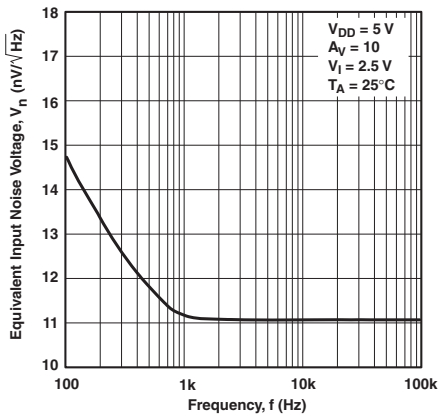

Figure 29. Equivalent Input Noise Voltage vs Frequency

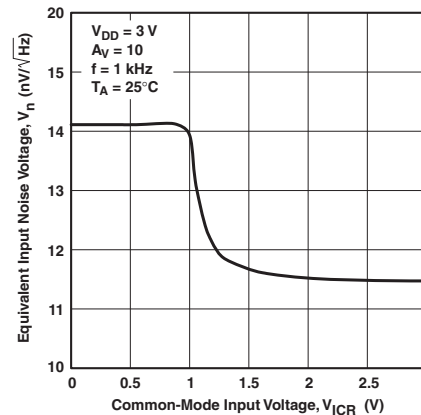

Figure 30. Equivalent Input Noise Voltage vs Common-Mode Input Voltage

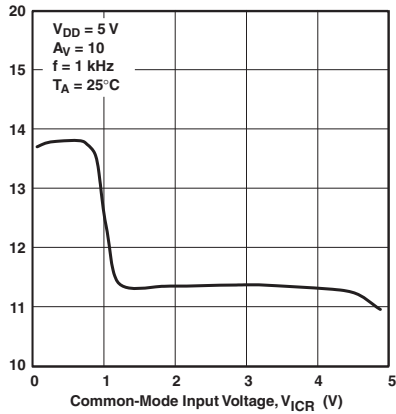

Figure 31. Equivalent Input Noise Voltage vs Common-Mode Input Voltage

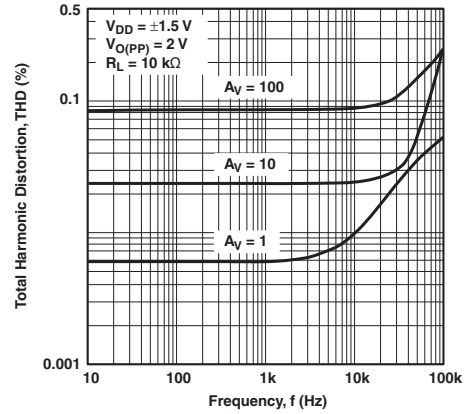

Figure 32. Total Harmonic Distortion vs Frequency,  $V_{DD} = \pm 1.5 V$

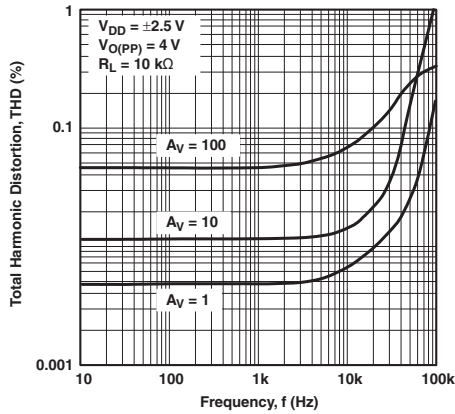

Figure 33. Total Harmonic Distortion vs Frequency,  $V_{DD} = \pm 2.5 V$

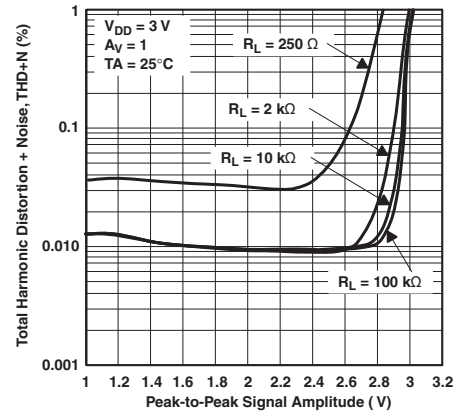

Figure 34. Total Harmonic Distortion Plus Noise vs Peak-to-Peak Signal Amplitude,  $V_{DD} = 3 V$

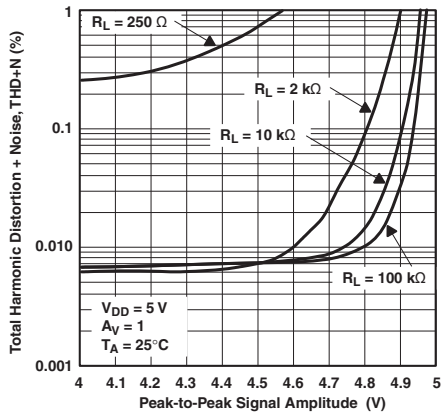

Figure 35. Total Harmonic Distortion Plus Noise vs Peak-to-Peak Signal Amplitude,  $V_{DD} = 5 V$

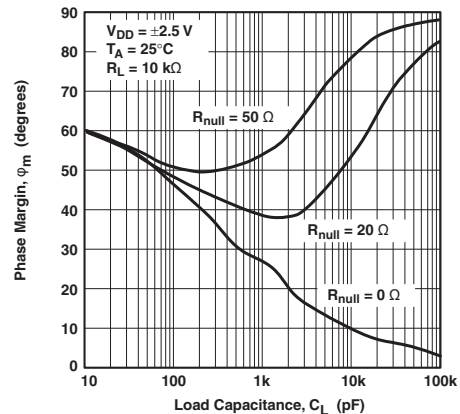

Figure 36. Phase Margin vs Load Capacitance

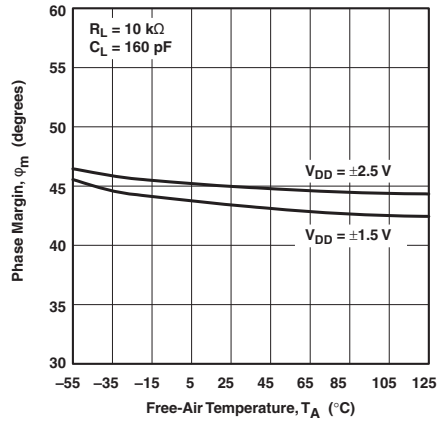

Figure 37. Phase Margin vs Free-Air Temperature

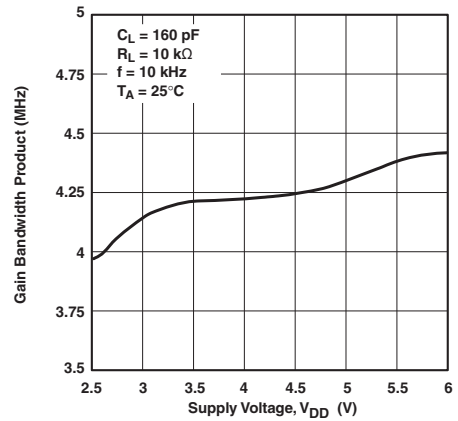

Figure 38. Gain Bandwidth Product vs Supply Voltage

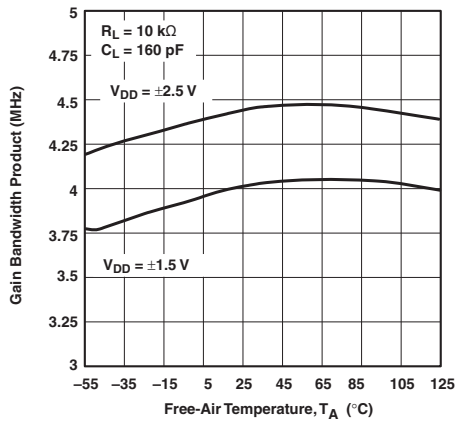

Figure 39. Gain Bandwidth Product vs Free-Air Temperature

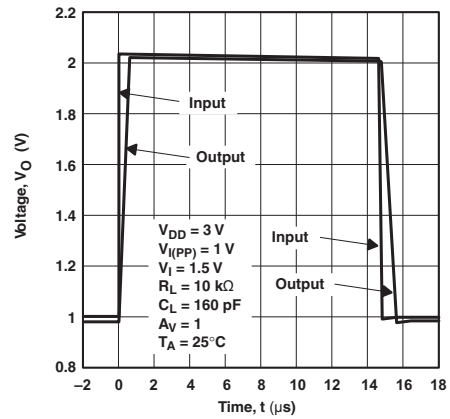

Figure 40. Large Signal Follower,  $V_{DD} = 3\text{ V}$

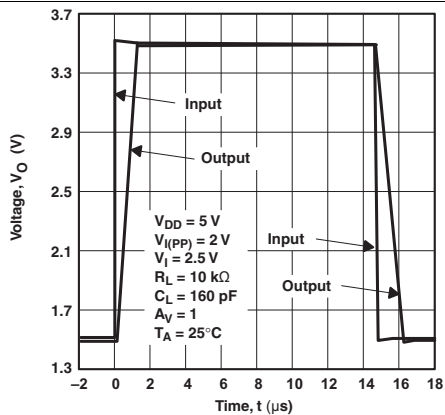

Figure 41. Large Signal Follower,  $V_{DD} = 5\text{ V}$

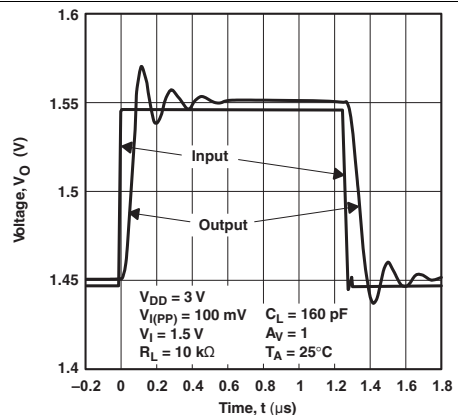

Figure 42. Small Signal Follower,  $V_{DD} = 3\text{ V}$

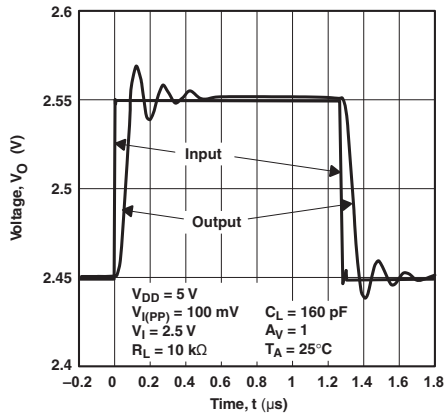

Figure 43. Small Signal Follower,  $V_{DD} = 5\text{ V}$

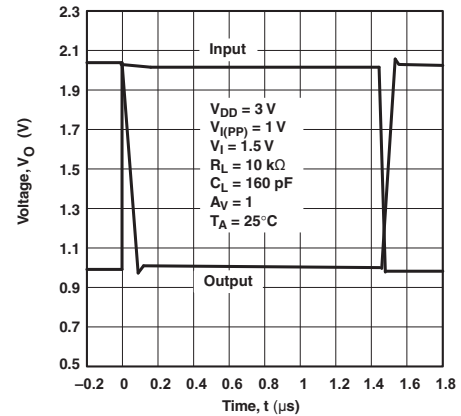

Figure 44. Inverting Large Signal,  $V_{DD} = 3\text{ V}$

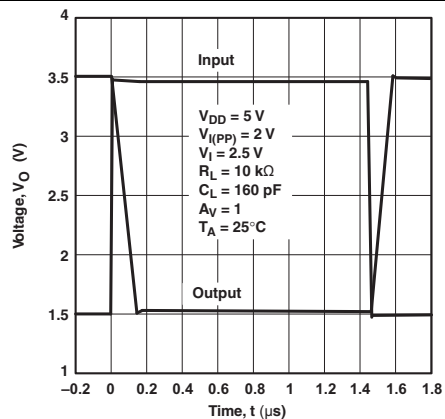

Figure 45. Inverting Large Signal,  $V_{DD} = 5\text{ V}$

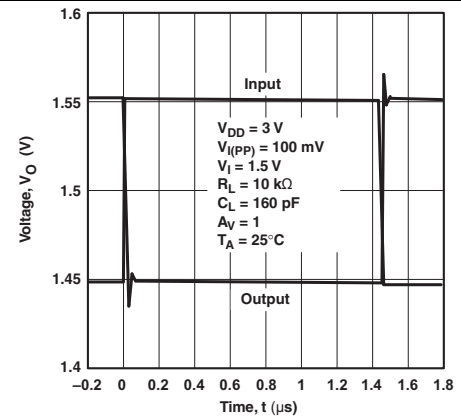

Figure 46. Inverting Small Signal,  $V_{DD} = 3\text{ V}$

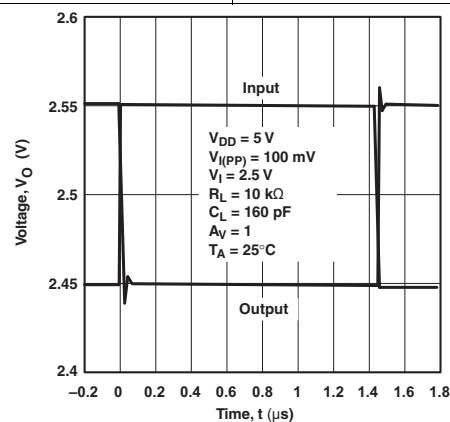

Figure 47. Inverting Small Signal,  $V_{DD} = 5\text{ V}$

## 8 Parameter Measurement Information

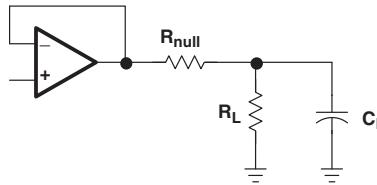

Figure 48. Capacitive Load Drive

## 9 Detailed Description

### 9.1 Overview

The TLV246x-Q1 family of devices are low-power rail-to-rail input and output operational amplifiers. The input common-mode voltage range extends beyond the supply rails for maximum dynamic range in a low-voltage system. The amplifier output has rail-to-rail performance with high drive capability, solving one of the limitations of older rail-to-rail input and output operational amplifiers

### 9.2 Functional Block Diagram

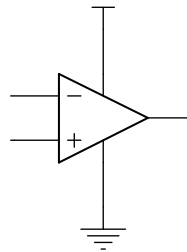

### 9.3 Feature Description

The TLV246x-Q1 family features 6.4-MHz bandwidth and voltage noise of 11 nV/ $\sqrt{\text{Hz}}$  with performance rated from 2.7 V to 6 V across an automotive temperature range ( $-40^{\circ}\text{C}$  to  $125^{\circ}\text{C}$ ). This family suits a wide range of automotive applications.

#### 9.3.1 Driving a Capacitive Load

When the amplifier configuration is in this manner, capacitive loading directly on the output decreases the phase margin of the device leading to high-frequency ringing or oscillations. Therefore, for capacitive loads of greater than 10 pF, the recommendation is that a resistor be placed in series ( $R_{\text{NULL}}$ ) with the output of the amplifier, see [Figure 49](#). A minimum value of 20  $\Omega$  works well for most applications.

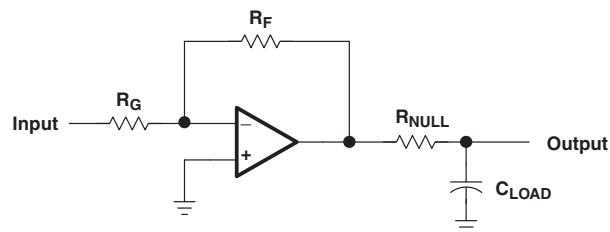

Figure 49. Driving a Capacitive Load

## Feature Description (continued)

### 9.3.2 Offset Voltage

The output offset voltage ( $V_{OO}$ ) is the sum of the input offset voltage ( $V_{IO}$ ) and both input-bias currents ( $I_{IB}$ ) times the corresponding gains. Use the schematic and formula in Figure 50 to calculate the output offset voltage.

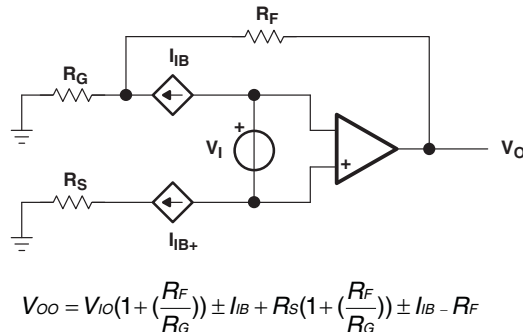

Figure 50. Output Offset Voltage Model

### 9.3.3 General Configurations

When receiving low-level signals, limiting the bandwidth of the incoming signals into the system is often required. The simplest way to accomplish this is to place an RC filter at the noninverting terminal of the amplifier (see Figure 51).

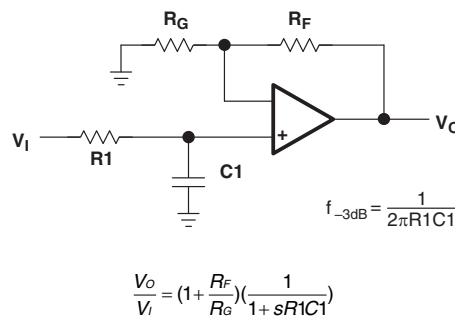

Figure 51. Single-Pole Low-Pass Filter

If even more attenuation is needed, a multiple pole filter is required. The Sallen-Key filter can be used for this task, see Figure 52. For best results, the amplifier should have a bandwidth that is eight to ten times the filter frequency bandwidth. Failure to do this can result in phase shift of the amplifier.

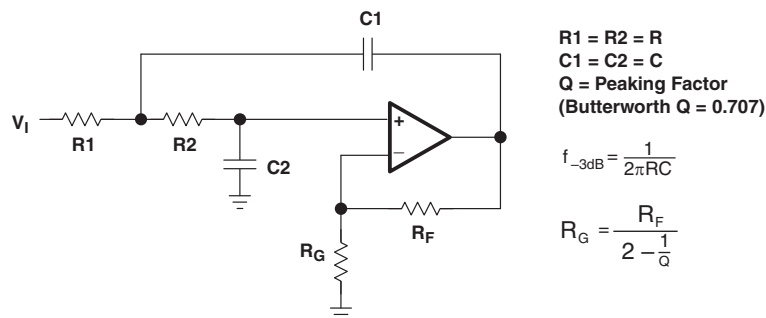

Figure 52. 2-Pole Low-Pass Sallen-Key Filter

## Feature Description (continued)

### 9.3.4 General Power Dissipation Considerations

For a given  $\theta_{JA}$ , the maximum power dissipation is shown in [Figure 53](#) and is calculated by [Equation 1](#):

$$P_D = \left( \frac{T_{MAX} - T_A}{\theta_{JA}} \right)$$

Where:

- $P_D$  = Maximum power dissipation of TLV246x-Q1 (watts)
- $T_{MAX}$  = Absolute maximum junction temperature (150°C)
- $T_A$  = Ambient free-air temperature (°C)
- $\theta_{JA} = \theta_{JC} + \theta_{CA}$
- $\theta_{JC}$  = Thermal coefficient from junction to case
- $\theta_{CA}$  = Thermal coefficient from case to ambient air (°C/W)

(1)

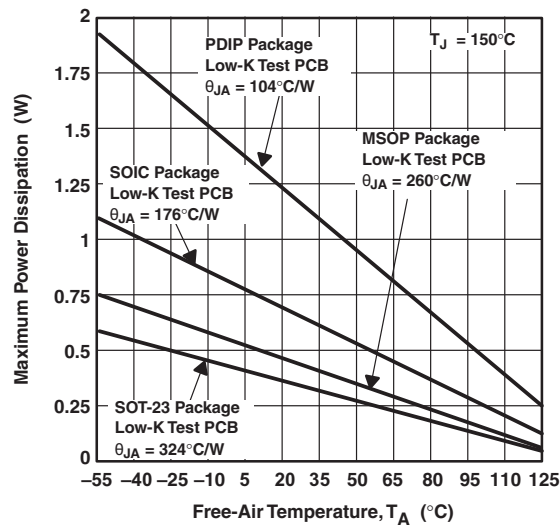

Figure 53. Maximum Power Dissipation vs Free-Air Temperature

## 9.4 Device Functional Modes

The TLV2461-Q1, TLV2462-Q1, and TLV2464A-Q1 power on when the supply is connected. These devices can operate with single supply or dual supplies, depending on the application. The devices are in their full performance once the supply is above the recommended value. The TLV2460-Q1 and TLV2463-Q1 devices additionally have a SHUTDOWN mode, which reduces the quiescent current to 0.3  $\mu\text{A}$  in SHUTDOWN mode.

### 9.4.1 SHUTDOWN Function

Two members of the TLV246x-Q1 family (TLV2460-Q1 and TLV2463-Q1) have a shutdown terminal for conserving battery life in portable applications. When the shutdown terminal is tied low, the supply current is reduced to 0.3  $\mu\text{A}/\text{channel}$ , the amplifier is disabled, and the outputs are placed in a high-impedance mode. To enable the amplifier, the shutdown terminal can either be left floating or pulled high. When the shutdown terminal is left floating, care should be taken to ensure that parasitic leakage current at the shutdown terminal does not inadvertently place the operational amplifier into shutdown. The shutdown terminal threshold is always referenced to  $V_{DD} / 2$ . Therefore, when operating the device with split supply voltages (for example,  $\pm 2.5\text{ V}$ ), the shutdown terminal must be pulled to  $V_{DD-}$  (not GND) to disable the operational amplifier.

The amplifier's output with a shutdown pulse is shown in [Figure 22](#), [Figure 23](#), [Figure 24](#), and [Figure 25](#). The amplifier is powered with a single 5-V supply and configured as a noninverting configuration with a gain of 5. The amplifier turnon and turnoff times are measured from the 50% point of the shutdown pulse to the 50% point of the output waveform. The times for the single, dual, and quad are listed in the data tables.

## 10 Application and Implementation

### NOTE

Information in the following applications sections is not part of the TI component specification, and TI does not warrant its accuracy or completeness. TI's customers are responsible for determining suitability of components for their purposes. Customers should validate and test their design implementation to confirm system functionality.

### 10.1 Application Information

Most DC-to-DC converters use output-filter ceramic capacitors with very low equivalent series resistance (ESR).

This causes a double pole at the resonance frequency  $\frac{1}{2\pi\sqrt{LC}}$ .

To achieve an adequate bandwidth and phase margin for the DC-to-DC converter, the device requires

compensation around the  $\frac{1}{2\pi\sqrt{LC}}$  resonance frequency. To achieve this, configure the error amplifier as type-3 compensation. The TLV2426x-Q1 device features a wide bandwidth UGBD of 6 MHz with rail-to-rail output for increased dynamic range. These features make the device suitable for DC-to-DC loop compensation with any LC filter.

#### 10.1.1 Macromodel Information

Macromodel information provided was derived using Microsim Parts™ Release 8, the model generation software used with Microsim PSpice™. The Boyle macromodel <sup>(1)</sup> and subcircuit in [Figure 54](#) were generated using the TLV246x-Q1 typical electrical and operating characteristics at  $T_A = 25^\circ\text{C}$ . Using this information, output simulations of the following key parameters can be generated to a tolerance of 20% (in most cases):

(1) G. R. Boyle, B. M. Cohn, D. O. Pederson, and J. E. Solomon, "Macromodeling of Integrated Circuit Operational Amplifiers," *IEEE Journal of Solid-State Circuits*, SC-9, 353 (1974).

- Maximum positive-output voltage swing
- Maximum negative-output voltage swing
- Slew rate
- Quiescent power dissipation
- Input bias current
- Open-loop voltage amplification
- Unity gain frequency
- Common-mode rejection ratio
- Phase margin
- DC output resistance
- AC output resistance
- Short-circuit output current limit



## 10.2 Typical Application

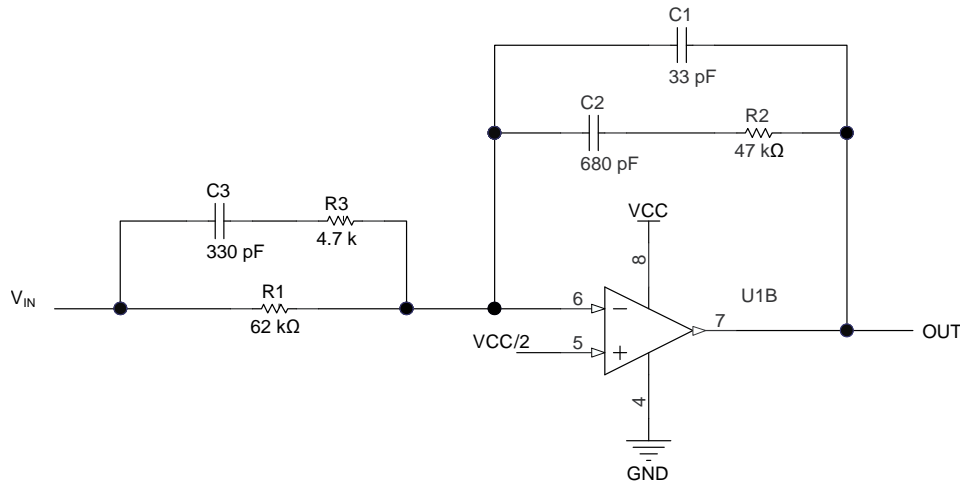

Figure 55. Typical Operational Amplifier Application

### 10.2.1 Design Requirements

See [Table 2](#) for Design Requirements.

Table 2. Recommended Design Parameters

PARAMETER	VALUE
Supply voltage	5 V
Reference voltage	2.5 V
Input voltage	2.5 VDC and maximum ripple 40 mV peak-to-peak
Capacitors	Better than X5R
Resistors	Better than 2% tolerance

### 10.2.2 Detailed Design Procedure

The following is the detailed design procedure. See [Equation 2](#) for the Type 3 compensation gain.

$$\text{Type 3 Compensation Gain} = \frac{(1 + R2C2s)(1 + (R1 + R3)C3s)}{R1(C1 + C2)s(1 + R2 \frac{C1C2}{C1 + C2}s)(1 + R3Cs)} \quad (2)$$

Type 3 compensation poles and zeros are shown in the ideal asymptotic graph, see [Figure 56](#). They can be moved around by changing the values of the resistors and capacitors according to the compensation requirement. The operational amplifier cannot achieve the ideal case, because of its open-loop gain and phase limitation.

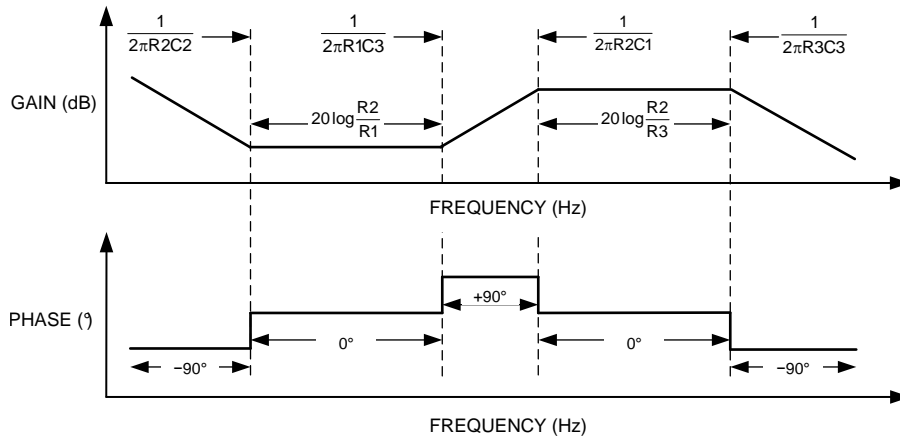

Figure 56. Ideal Asymptotic Graph

The poles and zeros are calculated assuming  $C2 \gg C1$  and  $R1 \gg R3$ . This assumption is correct, because  $C1$  and  $R3$  components set the high frequencies.

This TLV226x-Q1 device type-3 compensation circuit design boosts the gain and phase for the DC-to-DC converter around 30-KHz resonance frequencies. This corresponds to 1  $\mu$ H and 22  $\mu$ F for the output filter.

The operational amplifier can also be configured as type 2 compensation by omitting the  $C3$  capacitor. Type 2 can compensate the DC-to-DC converter with an output capacitor that has a series resistor ESR. See Equation 3.

$$\text{Type 2 Compensation Gain} = \frac{(1 + R2C2s)}{R1(C1 + C2) s (1 + R2 \frac{C1C2}{C1+C2} s)} \quad (3)$$

### 10.2.3 Application Curve

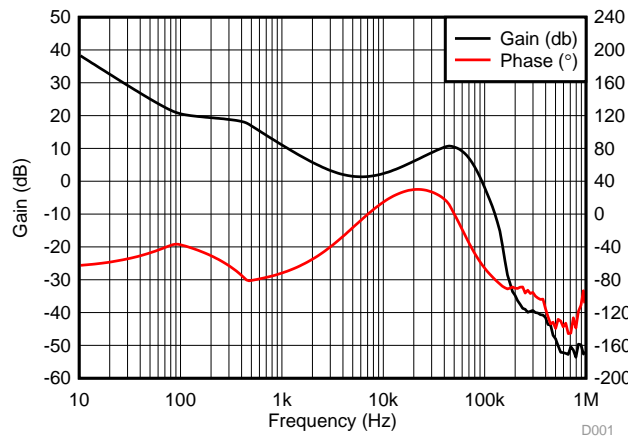

Frequency: 10 Hz to 1 MHz Gain Boost = 12 dB around 30 KHz Phase Boost = 30° around 30 KHz

Figure 57. Gain and Phase Plot

## 11 Power Supply Recommendations

The TLV246X-Q1 family of devices operation specification is from 2.7 V to 6 V for a single power supply and  $\pm 1.35$  V to  $\pm 3$  V for dual power supplies.

A 0.1- $\mu$ F bypass capacitor close to the power supply pins is recommended to reduce errors coupling in from noisy or high-impedance power supplies.

## 12 Layout

### 12.1 Layout Guidelines

To achieve the levels of high performance of the TLV246x-Q1, follow proper printed-circuit board design techniques. A general set of guidelines is given in the following.

- Ground planes – TI recommends that a ground plane be used on the board to provide all components with a low inductive ground connection. However, in the areas of the amplifier inputs and output, the ground plane can be removed to minimize the stray capacitance.
- Proper power supply decoupling – Use a 6.8- $\mu\text{F}$  tantalum capacitor in parallel with a 0.1- $\mu\text{F}$  ceramic capacitor on each supply terminal. It may be possible to share the tantalum among several amplifiers depending on the application, but a 0.1- $\mu\text{F}$  ceramic capacitor should always be used on the supply terminal of every amplifier. In addition, the 0.1- $\mu\text{F}$  capacitor should be placed as close as possible to the supply terminal. As this distance increases, the inductance in the connecting trace makes the capacitor less effective. The designer should strive for distances of less than 0.1 inches between the device power terminals and the ceramic capacitors.
- Sockets – Sockets can be used but are not recommended. The additional lead inductance in the socket pins often leads to stability problems. Surface-mount packages soldered directly to the printed circuit board is the best implementation.
- Short trace runs/compact part placements – Optimum high performance is achieved when stray series inductance has been minimized. To realize this, the circuit layout should be made as compact as possible, thereby minimizing the length of all trace runs. Particular attention should be paid to the inverting input of the amplifier. Its length should be kept as short as possible. This minimizes stray capacitance at the input of the amplifier.
- Surface-mount passive components – Using surface-mount passive components is recommended for high-performance amplifier circuits for several reasons. First, because of the extremely low lead inductance of surface-mount components, the problem with stray series inductance is greatly reduced. Second, the small size of surface-mount components naturally leads to a more compact layout, thereby minimizing both stray inductance and capacitance. If leaded components are used, it is recommended that the lead lengths be kept as short as possible.

### 12.2 Layout Example

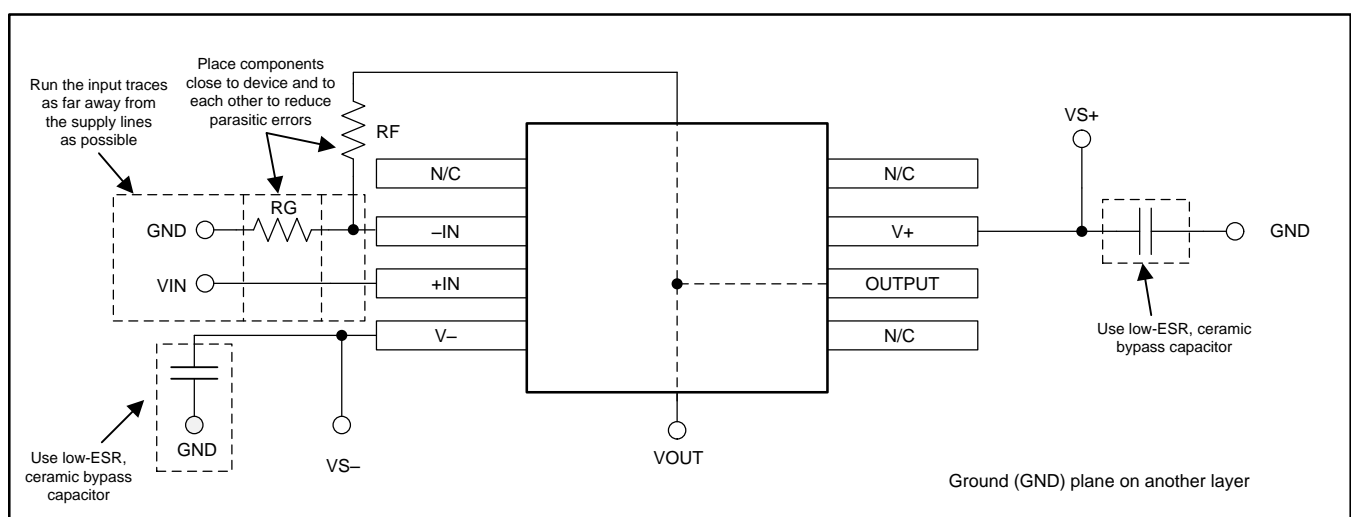
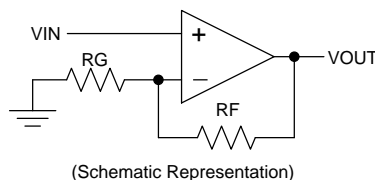

Figure 58. Operational Amplifier Board Layout for Noninverting Configuration

## 13 Device and Documentation Support

### 13.1 Documentation Support

#### 13.1.1 Related Documentation

For related documentation see the following:

- *An audio circuit collection, Part 1*, Technical brief, [SLYT155](#)
- G. R. Boyle, B. M. Cohn, D. O. Pederson, and J. E. Solomon, "Macromodeling of Integrated Circuit Operational Amplifiers," *IEEE Journal of Solid-State Circuits*, SC-9, 353 (1974).

### 13.2 Related Links

The table below lists quick access links. Categories include technical documents, support and community resources, tools and software, and quick access to sample or buy.

**Table 3. Related Links**

PARTS	PRODUCT FOLDER	SAMPLE & BUY	TECHNICAL DOCUMENTS	TOOLS & SOFTWARE	SUPPORT & COMMUNITY
TLV2460-Q1	<a href="#">Click here</a>	<a href="#">Click here</a>	<a href="#">Click here</a>	<a href="#">Click here</a>	<a href="#">Click here</a>
TLV2461-Q1	<a href="#">Click here</a>	<a href="#">Click here</a>	<a href="#">Click here</a>	<a href="#">Click here</a>	<a href="#">Click here</a>
TLV2462-Q1	<a href="#">Click here</a>	<a href="#">Click here</a>	<a href="#">Click here</a>	<a href="#">Click here</a>	<a href="#">Click here</a>
TLV2463-Q1	<a href="#">Click here</a>	<a href="#">Click here</a>	<a href="#">Click here</a>	<a href="#">Click here</a>	<a href="#">Click here</a>
TLV2460A-Q1	<a href="#">Click here</a>	<a href="#">Click here</a>	<a href="#">Click here</a>	<a href="#">Click here</a>	<a href="#">Click here</a>
TLV2461A-Q1	<a href="#">Click here</a>	<a href="#">Click here</a>	<a href="#">Click here</a>	<a href="#">Click here</a>	<a href="#">Click here</a>
TLV2462A-Q1	<a href="#">Click here</a>	<a href="#">Click here</a>	<a href="#">Click here</a>	<a href="#">Click here</a>	<a href="#">Click here</a>
TLV2463A-Q1	<a href="#">Click here</a>	<a href="#">Click here</a>	<a href="#">Click here</a>	<a href="#">Click here</a>	<a href="#">Click here</a>
TLV2464A-Q1	<a href="#">Click here</a>	<a href="#">Click here</a>	<a href="#">Click here</a>	<a href="#">Click here</a>	<a href="#">Click here</a>

### 13.3 Community Resources

The following links connect to TI community resources. Linked contents are provided "AS IS" by the respective contributors. They do not constitute TI specifications and do not necessarily reflect TI's views; see TI's [Terms of Use](#).

**TI E2E™ Online Community** *TI's Engineer-to-Engineer (E2E) Community*. Created to foster collaboration among engineers. At [e2e.ti.com](http://e2e.ti.com), you can ask questions, share knowledge, explore ideas and help solve problems with fellow engineers.

**Design Support** *TI's Design Support* Quickly find helpful E2E forums along with design support tools and contact information for technical support.

### 13.4 Trademarks

E2E is a trademark of Texas Instruments.  
All other trademarks are the property of their respective owners.

### 13.5 Electrostatic Discharge Caution



These devices have limited built-in ESD protection. The leads should be shorted together or the device placed in conductive foam during storage or handling to prevent electrostatic damage to the MOS gates.

### 13.6 Glossary

[SLYZ022](#) — *TI Glossary*.





This glossary lists and explains terms, acronyms, and definitions.

## 14 Mechanical, Packaging, and Orderable Information

The following pages include mechanical, packaging, and orderable information. This information is the most current data available for the designated devices. This data is subject to change without notice and revision of this document. For browser-based versions of this data sheet, refer to the left-hand navigation.

**PACKAGING INFORMATION**

Orderable Device	Status (1)	Package Type	Package Drawing	Pins	Package Qty	Eco Plan (2)	Lead/Ball Finish (6)	MSL Peak Temp (3)	Op Temp (°C)	Device Marking (4/5)	Samples
TLV2460AQDRQ1	OBSOLETE	SOIC	D	8		TBD	Call TI	Call TI	-40 to 125	2460AQ	
TLV2460AQPWRG4Q1	ACTIVE	TSSOP	PW	8	2000	Green (RoHS & no Sb/Br)	CU NIPDAU	Level-1-260C-UNLIM	-40 to 125	2460AQ	<a href="#">Samples</a>
TLV2460AQPWRQ1	OBSOLETE	TSSOP	PW	8		TBD	Call TI	Call TI	-40 to 125		
TLV2460QDRQ1	OBSOLETE	SOIC	D	8		TBD	Call TI	Call TI	-40 to 125		
TLV2460QPWRG4Q1	ACTIVE	TSSOP	PW	8	2000	Green (RoHS & no Sb/Br)	CU NIPDAU	Level-1-260C-UNLIM	-40 to 125	2460Q1	<a href="#">Samples</a>
TLV2460QPWRQ1	OBSOLETE	TSSOP	PW	8		TBD	Call TI	Call TI	-40 to 125		
TLV2461AQDRQ1	OBSOLETE	SOIC	D	8		TBD	Call TI	Call TI	-40 to 125		
TLV2461AQPWRG4Q1	ACTIVE	TSSOP	PW	8	2000	Green (RoHS & no Sb/Br)	CU NIPDAU	Level-1-260C-UNLIM	-40 to 125	2461AQ	<a href="#">Samples</a>
TLV2461AQPWRQ1	OBSOLETE	TSSOP	PW	8		TBD	Call TI	Call TI	-40 to 125		
TLV2461QDRQ1	OBSOLETE	SOIC	D	8		TBD	Call TI	Call TI	-40 to 125	2461Q1	
TLV2461QPWRG4Q1	ACTIVE	TSSOP	PW	8	2000	Green (RoHS & no Sb/Br)	CU NIPDAU	Level-1-260C-UNLIM	-40 to 125	2461Q1	<a href="#">Samples</a>
TLV2461QPWRQ1	OBSOLETE	TSSOP	PW	8		TBD	Call TI	Call TI	-40 to 125		
TLV2462AQDRG4Q1	ACTIVE	SOIC	D	8	2500	Green (RoHS & no Sb/Br)	CU NIPDAU	Level-1-260C-UNLIM	-40 to 125	2462AQ	<a href="#">Samples</a>
TLV2462AQDRQ1	ACTIVE	SOIC	D	8	2500	Green (RoHS & no Sb/Br)	CU NIPDAU	Level-1-260C-UNLIM	-40 to 125	2462AQ	<a href="#">Samples</a>
TLV2462AQPWRG4Q1	ACTIVE	TSSOP	PW	8	2000	Green (RoHS & no Sb/Br)	CU NIPDAU	Level-1-260C-UNLIM	-40 to 125	2462AQ	<a href="#">Samples</a>
TLV2462AQPWRQ1	ACTIVE	TSSOP	PW	8	2000	Green (RoHS & no Sb/Br)	CU NIPDAU	Level-1-260C-UNLIM	-40 to 125	2462AQ	<a href="#">Samples</a>
TLV2462QDGKRQ1	ACTIVE	VSSOP	DGK	8	2500	Green (RoHS & no Sb/Br)	CU NIPDAU   CU NIPDAUAG	Level-2-260C-1 YEAR	-40 to 125	QVM	<a href="#">Samples</a>
TLV2462QDRG4Q1	ACTIVE	SOIC	D	8	2500	Green (RoHS & no Sb/Br)	CU NIPDAU	Level-1-260C-UNLIM	-40 to 125	2462Q1	<a href="#">Samples</a>
TLV2462QDRQ1	ACTIVE	SOIC	D	8	2500	Green (RoHS & no Sb/Br)	CU NIPDAU	Level-1-260C-UNLIM	-40 to 125	2462Q1	<a href="#">Samples</a>
TLV2462QPWRG4Q1	ACTIVE	TSSOP	PW	8	2000	Green (RoHS & no Sb/Br)	CU NIPDAU	Level-1-260C-UNLIM	-40 to 125	2462Q1	<a href="#">Samples</a>
TLV2462QPWRQ1	OBSOLETE	TSSOP	PW	8		TBD	Call TI	Call TI	-40 to 125		

Orderable Device	Status (1)	Package Type	Package Drawing	Pins	Package Qty	Eco Plan (2)	Lead/Ball Finish (6)	MSL Peak Temp (3)	Op Temp (°C)	Device Marking (4/5)	Samples
TLV2463AQDRQ1	OBSOLETE	SOIC	D	14		TBD	Call TI	Call TI	-40 to 125		
TLV2463AQPWRG4Q1	ACTIVE	TSSOP	PW	14	2000	Green (RoHS & no Sb/Br)	CU NIPDAU	Level-1-260C-UNLIM	-40 to 125	2463AQ1	
TLV2463AQPWRQ1	OBSOLETE	TSSOP	PW	14		TBD	Call TI	Call TI	-40 to 125		
TLV2463QDRQ1	OBSOLETE	SOIC	D	14		TBD	Call TI	Call TI	-40 to 125		
TLV2463QPWRG4Q1	ACTIVE	TSSOP	PW	14	2000	Green (RoHS & no Sb/Br)	CU NIPDAU	Level-1-260C-UNLIM	-40 to 125	2463Q1	
TLV2463QPWRQ1	OBSOLETE	TSSOP	PW	14		TBD	Call TI	Call TI	-40 to 125		
TLV2464AQPWRG4Q1	ACTIVE	TSSOP	PW	14	2000	Green (RoHS & no Sb/Br)	CU NIPDAU	Level-1-260C-UNLIM	-40 to 125	V2464AQ	
TLV2464AQPWRQ1	ACTIVE	TSSOP	PW	14	2000	Green (RoHS & no Sb/Br)	CU NIPDAU	Level-1-260C-UNLIM	-40 to 125	V2464AQ	

(1) The marketing status values are defined as follows:

**ACTIVE:** Product device recommended for new designs.

**LIFEBUY:** TI has announced that the device will be discontinued, and a lifetime-buy period is in effect.

**NRND:** Not recommended for new designs. Device is in production to support existing customers, but TI does not recommend using this part in a new design.

**PREVIEW:** Device has been announced but is not in production. Samples may or may not be available.

**OBSOLETE:** TI has discontinued the production of the device.

(2) Eco Plan - The planned eco-friendly classification: Pb-Free (RoHS), Pb-Free (RoHS Exempt), or Green (RoHS & no Sb/Br) - please check <http://www.ti.com/productcontent> for the latest availability information and additional product content details.

**TBD:** The Pb-Free/Green conversion plan has not been defined.

**Pb-Free (RoHS):** TI's terms "Lead-Free" or "Pb-Free" mean semiconductor products that are compatible with the current RoHS requirements for all 6 substances, including the requirement that lead not exceed 0.1% by weight in homogeneous materials. Where designed to be soldered at high temperatures, TI Pb-Free products are suitable for use in specified lead-free processes.

**Pb-Free (RoHS Exempt):** This component has a RoHS exemption for either 1) lead-based flip-chip solder bumps used between the die and package, or 2) lead-based die adhesive used between the die and leadframe. The component is otherwise considered Pb-Free (RoHS compatible) as defined above.

**Green (RoHS & no Sb/Br):** TI defines "Green" to mean Pb-Free (RoHS compatible), and free of Bromine (Br) and Antimony (Sb) based flame retardants (Br or Sb do not exceed 0.1% by weight in homogeneous material)

(3) MSL, Peak Temp. - The Moisture Sensitivity Level rating according to the JEDEC industry standard classifications, and peak solder temperature.

(4) There may be additional marking, which relates to the logo, the lot trace code information, or the environmental category on the device.

(5) Multiple Device Markings will be inside parentheses. Only one Device Marking contained in parentheses and separated by a "~" will appear on a device. If a line is indented then it is a continuation of the previous line and the two combined represent the entire Device Marking for that device.

---

<sup>(6)</sup> Lead/Ball Finish - Orderable Devices may have multiple material finish options. Finish options are separated by a vertical ruled line. Lead/Ball Finish values may wrap to two lines if the finish value exceeds the maximum column width.

**Important Information and Disclaimer:**The information provided on this page represents TI's knowledge and belief as of the date that it is provided. TI bases its knowledge and belief on information provided by third parties, and makes no representation or warranty as to the accuracy of such information. Efforts are underway to better integrate information from third parties. TI has taken and continues to take reasonable steps to provide representative and accurate information but may not have conducted destructive testing or chemical analysis on incoming materials and chemicals. TI and TI suppliers consider certain information to be proprietary, and thus CAS numbers and other limited information may not be available for release.

In no event shall TI's liability arising out of such information exceed the total purchase price of the TI part(s) at issue in this document sold by TI to Customer on an annual basis.

**OTHER QUALIFIED VERSIONS OF TLV2460-Q1, TLV2460A-Q1, TLV2461-Q1, TLV2461A-Q1, TLV2462-Q1, TLV2462A-Q1, TLV2463-Q1, TLV2463A-Q1, TLV2464A-Q1 :**

- Catalog: [TLV2460](#), [TLV2460A](#), [TLV2461](#), [TLV2461A](#), [TLV2462](#), [TLV2462A](#), [TLV2463](#), [TLV2463A](#), [TLV2464A](#)
- Enhanced Product: [TLV2462A-EP](#), [TLV2464A-EP](#)
- Military: [TLV2460M](#), [TLV2461M](#), [TLV2462M](#), [TLV2462AM](#), [TLV2463AM](#)

NOTE: Qualified Version Definitions:

- Catalog - TI's standard catalog product
- Enhanced Product - Supports Defense, Aerospace and Medical Applications
- Military - QML certified for Military and Defense Applications

**TAPE AND REEL INFORMATION**

**QUADRANT ASSIGNMENTS FOR PIN 1 ORIENTATION IN TAPE**

\*All dimensions are nominal

Device	Package Type	Package Drawing	Pins	SPQ	Reel Diameter (mm)	Reel Width W1 (mm)	A0 (mm)	B0 (mm)	K0 (mm)	P1 (mm)	W (mm)	Pin1 Quadrant
TLV2460AQPWRG4Q1	TSSOP	PW	8	2000	330.0	12.4	7.0	3.6	1.6	8.0	12.0	Q1
TLV2460QPWRG4Q1	TSSOP	PW	8	2000	330.0	12.4	7.0	3.6	1.6	8.0	12.0	Q1
TLV2461AQPWRG4Q1	TSSOP	PW	8	2000	330.0	12.4	7.0	3.6	1.6	8.0	12.0	Q1
TLV2461QPWRG4Q1	TSSOP	PW	8	2000	330.0	12.4	7.0	3.6	1.6	8.0	12.0	Q1
TLV2462AQPWRG4Q1	TSSOP	PW	8	2000	330.0	12.4	7.0	3.6	1.6	8.0	12.0	Q1
TLV2462AQWRQ1	TSSOP	PW	8	2000	330.0	12.4	7.0	3.6	1.6	8.0	12.0	Q1
TLV2462QDGRQ1	VSSOP	DGK	8	2500	330.0	12.4	5.3	3.4	1.4	8.0	12.0	Q1
TLV2462QDGRQ1	VSSOP	DGK	8	2500	330.0	12.4	5.3	3.4	1.4	8.0	12.0	Q1
TLV2462QPWRG4Q1	TSSOP	PW	8	2000	330.0	12.4	7.0	3.6	1.6	8.0	12.0	Q1
TLV2463AQPWRG4Q1	TSSOP	PW	14	2000	330.0	12.4	6.9	5.6	1.6	8.0	12.0	Q1
TLV2463QPWRG4Q1	TSSOP	PW	14	2000	330.0	12.4	6.9	5.6	1.6	8.0	12.0	Q1
TLV2464AQPWRG4Q1	TSSOP	PW	14	2000	330.0	12.4	6.9	5.6	1.6	8.0	12.0	Q1
TLV2464AQWRQ1	TSSOP	PW	14	2000	330.0	12.4	6.9	5.6	1.6	8.0	12.0	Q1

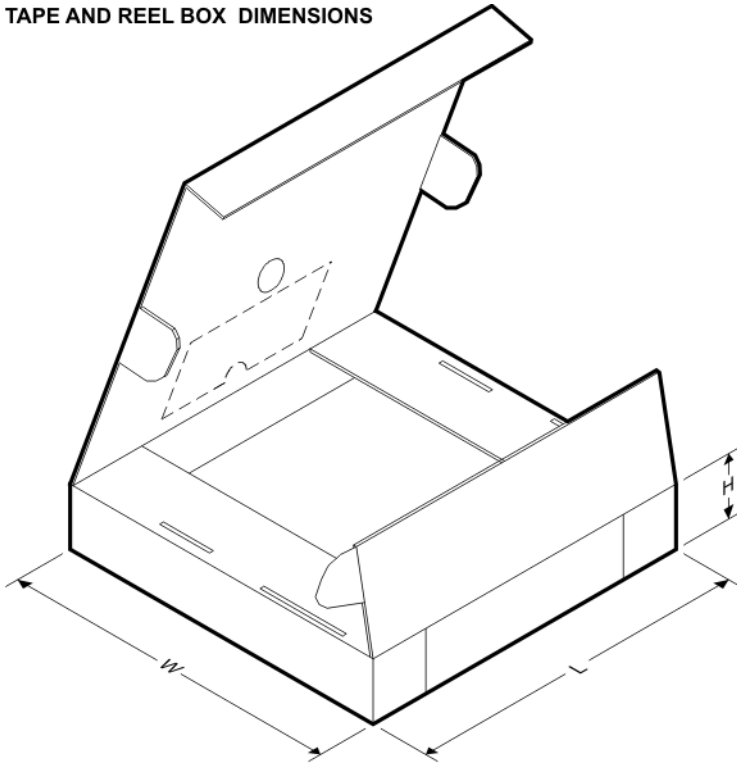
**TAPE AND REEL BOX DIMENSIONS**

\*All dimensions are nominal

Device	Package Type	Package Drawing	Pins	SPQ	Length (mm)	Width (mm)	Height (mm)
TLV2460AQPWRG4Q1	TSSOP	PW	8	2000	367.0	367.0	35.0
TLV2460QPWRG4Q1	TSSOP	PW	8	2000	367.0	367.0	35.0
TLV2461AQPWRG4Q1	TSSOP	PW	8	2000	367.0	367.0	35.0
TLV2461QPWRG4Q1	TSSOP	PW	8	2000	367.0	367.0	35.0
TLV2462AQPWRG4Q1	TSSOP	PW	8	2000	367.0	367.0	35.0
TLV2462AQPWRQ1	TSSOP	PW	8	2000	367.0	367.0	35.0
TLV2462QDQKRQ1	VSSOP	DGK	8	2500	358.0	335.0	35.0
TLV2462QDQKRQ1	VSSOP	DGK	8	2500	364.0	364.0	27.0
TLV2462QPWRG4Q1	TSSOP	PW	8	2000	367.0	367.0	35.0
TLV2463AQPWRG4Q1	TSSOP	PW	14	2000	367.0	367.0	35.0
TLV2463QPWRG4Q1	TSSOP	PW	14	2000	367.0	367.0	35.0
TLV2464AQPWRG4Q1	TSSOP	PW	14	2000	367.0	367.0	35.0
TLV2464AQPWRQ1	TSSOP	PW	14	2000	367.0	367.0	35.0





- NOTES:
- A. All linear dimensions are in millimeters.
  - B. This drawing is subject to change without notice.
  - C. Publication IPC-7351 is recommended for alternate designs.
  - D. Laser cutting apertures with trapezoidal walls and also rounding corners will offer better paste release. Customers should contact their board assembly site for stencil design recommendations. Refer to IPC-7525 for other stencil recommendations.
  - E. Customers should contact their board fabrication site for solder mask tolerances between and around signal pads.

D (R-PDSO-G14)

PLASTIC SMALL OUTLINE

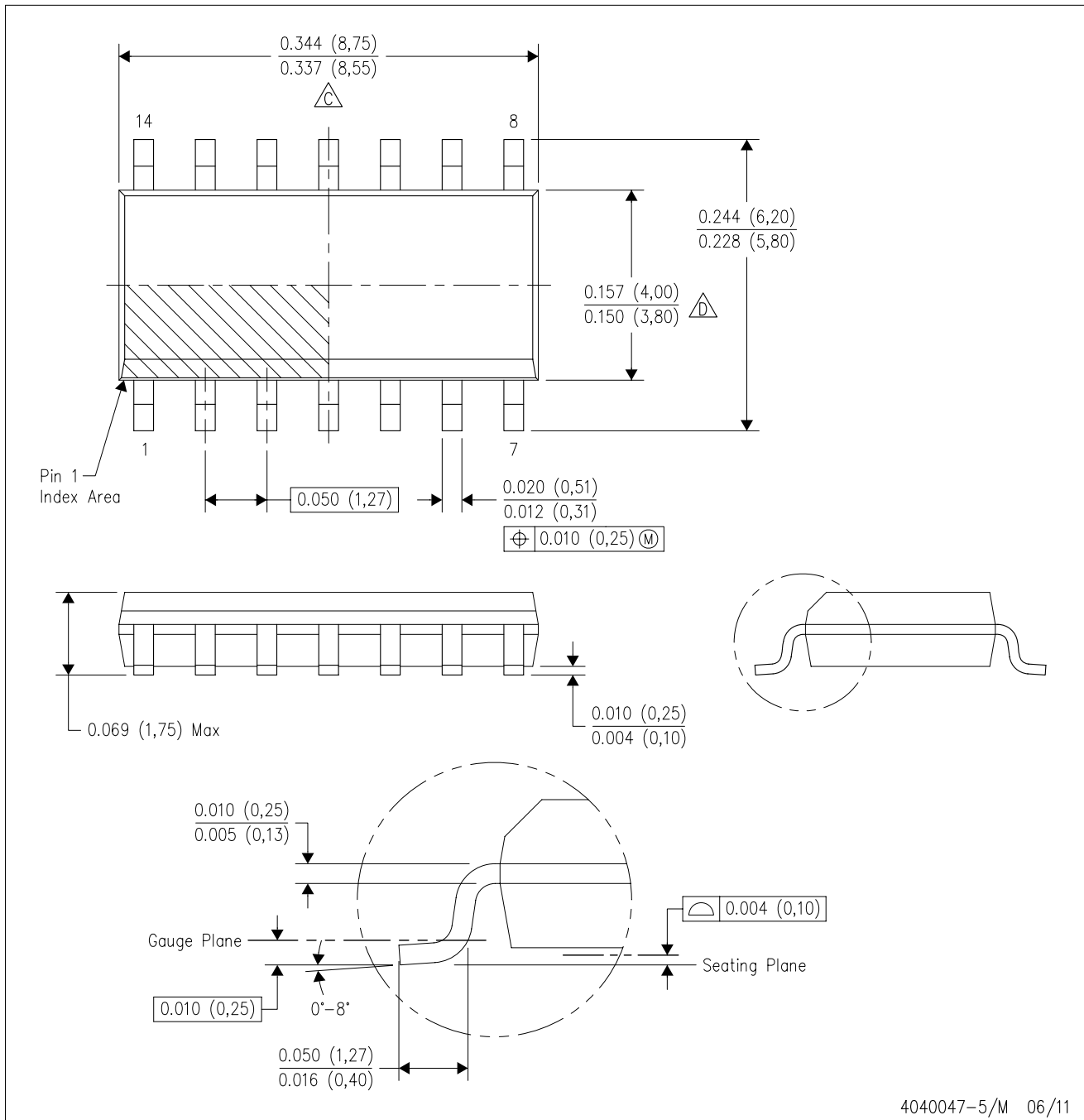

- NOTES:
- A. All linear dimensions are in inches (millimeters).
  - B. This drawing is subject to change without notice.
  - Body length does not include mold flash, protrusions, or gate burrs. Mold flash, protrusions, or gate burrs shall not exceed 0.006 (0,15) each side.
  - Body width does not include interlead flash. Interlead flash shall not exceed 0.017 (0,43) each side.
  - E. Reference JEDEC MS-012 variation AB.

PW (R-PDSO-G14)

PLASTIC SMALL OUTLINE

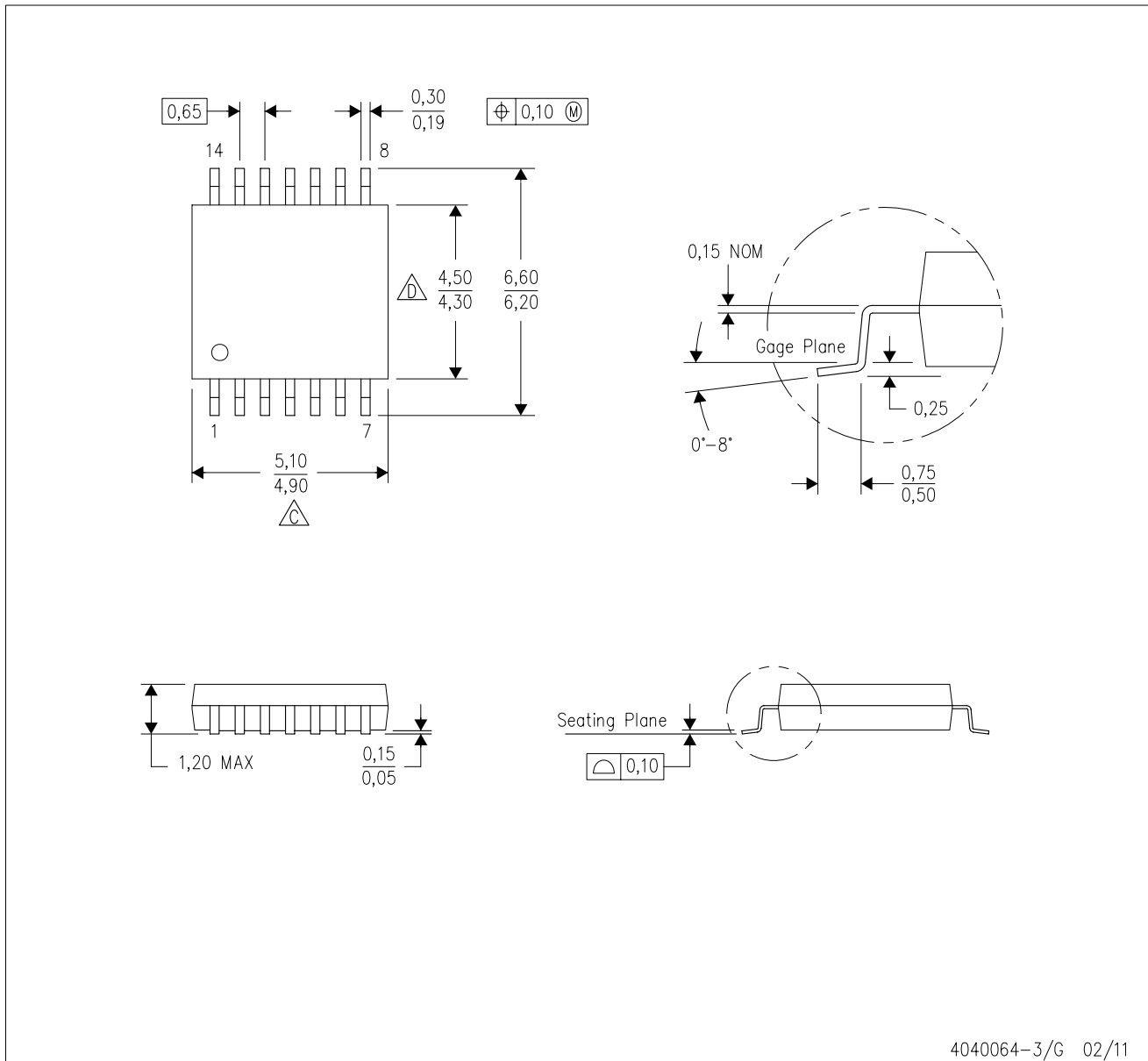

- NOTES:
- A. All linear dimensions are in millimeters. Dimensioning and tolerancing per ASME Y14.5M-1994.
  - B. This drawing is subject to change without notice.
  - C. Body length does not include mold flash, protrusions, or gate burrs. Mold flash, protrusions, or gate burrs shall not exceed 0,15 each side.
  - D. Body width does not include interlead flash. Interlead flash shall not exceed 0,25 each side.
  - E. Falls within JEDEC MO-153

PW (R-PDSO-G14)

PLASTIC SMALL OUTLINE

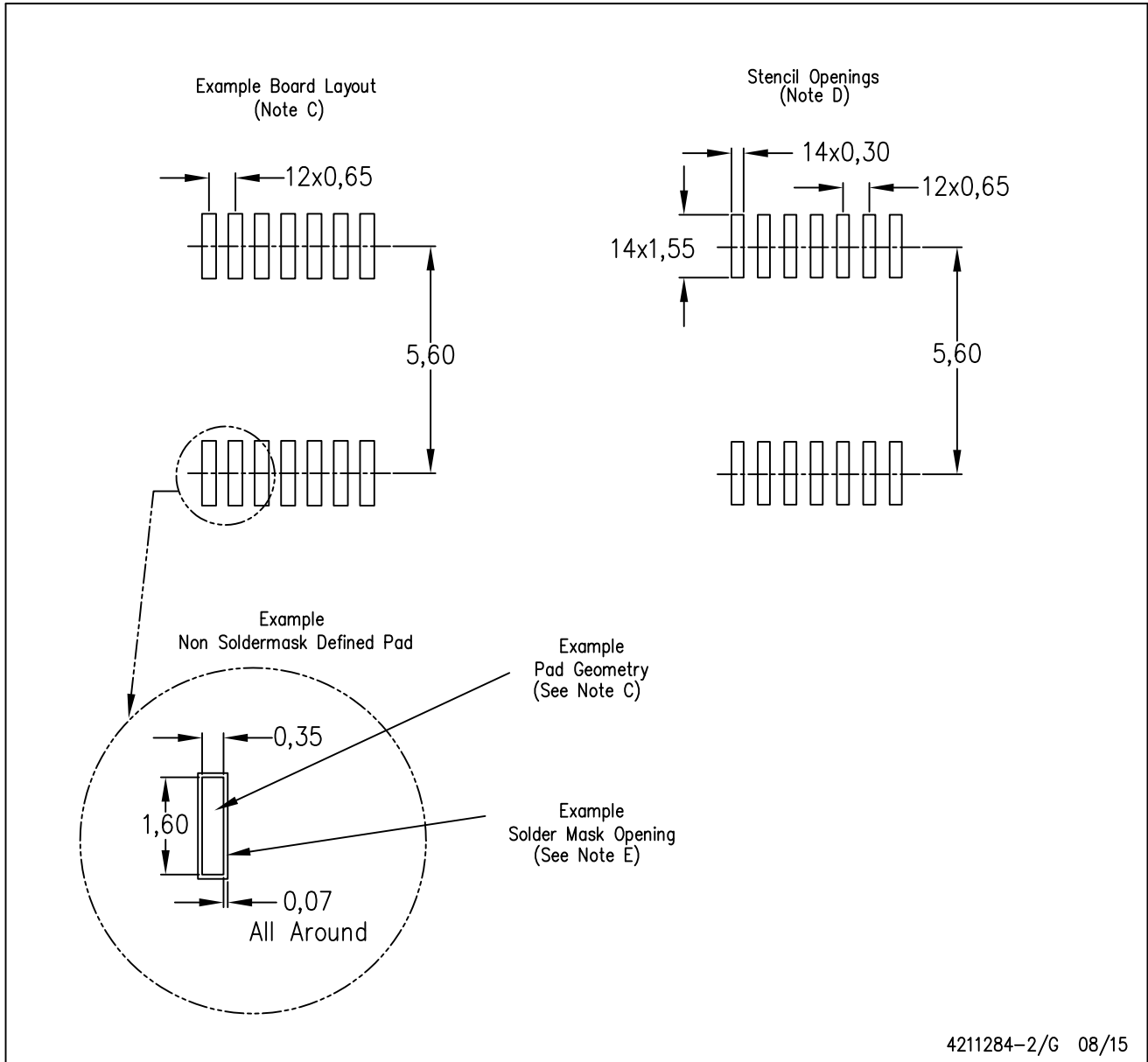

4211284-2/G 08/15

- NOTES:
- All linear dimensions are in millimeters.
  - This drawing is subject to change without notice.
  - Publication IPC-7351 is recommended for alternate designs.
  - Laser cutting apertures with trapezoidal walls and also rounding corners will offer better paste release. Customers should contact their board assembly site for stencil design recommendations. Refer to IPC-7525 for other stencil recommendations.
  - Customers should contact their board fabrication site for solder mask tolerances between and around signal pads.

PW0008A



PACKAGE OUTLINE  
TSSOP - 1.2 mm max height

SMALL OUTLINE PACKAGE

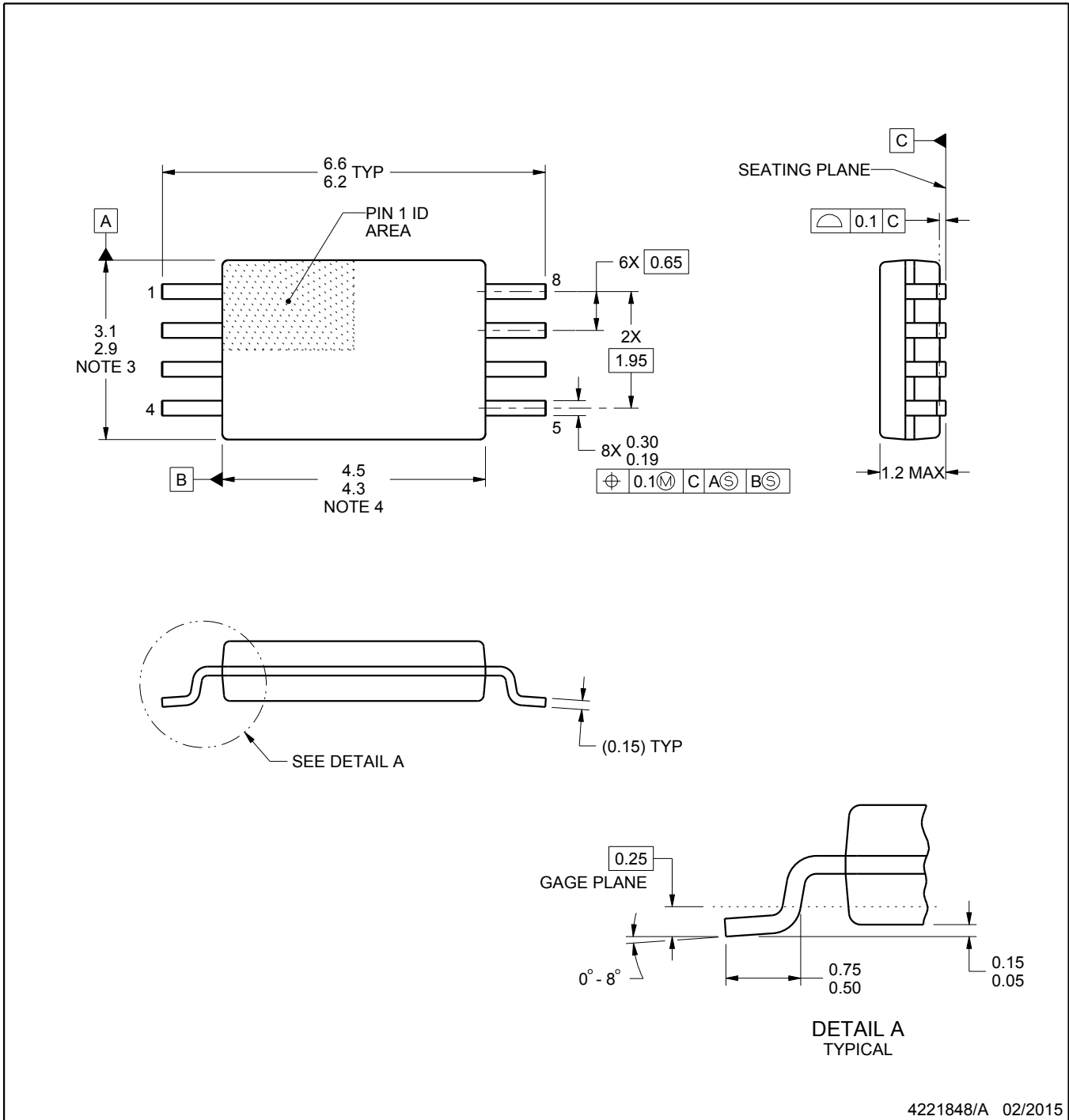

4221848/A 02/2015

NOTES:

1. All linear dimensions are in millimeters. Any dimensions in parenthesis are for reference only. Dimensioning and tolerancing per ASME Y14.5M.
2. This drawing is subject to change without notice.
3. This dimension does not include mold flash, protrusions, or gate burrs. Mold flash, protrusions, or gate burrs shall not exceed 0.15 mm per side.
4. This dimension does not include interlead flash. Interlead flash shall not exceed 0.25 mm per side.
5. Reference JEDEC registration MO-153, variation AA.

# EXAMPLE BOARD LAYOUT

PW0008A

TSSOP - 1.2 mm max height

SMALL OUTLINE PACKAGE



LAND PATTERN EXAMPLE  
SCALE:10X



SOLDER MASK DETAILS  
NOT TO SCALE

4221848/A 02/2015

NOTES: (continued)

- 6. Publication IPC-7351 may have alternate designs.
- 7. Solder mask tolerances between and around signal pads can vary based on board fabrication site.

# EXAMPLE STENCIL DESIGN

PW0008A

TSSOP - 1.2 mm max height

SMALL OUTLINE PACKAGE



SOLDER PASTE EXAMPLE  
BASED ON 0.125 mm THICK STENCIL  
SCALE:10X

4221848/A 02/2015

NOTES: (continued)

8. Laser cutting apertures with trapezoidal walls and rounded corners may offer better paste release. IPC-7525 may have alternate design recommendations.
9. Board assembly site may have different recommendations for stencil design.

D (R-PDSO-G8)

PLASTIC SMALL OUTLINE

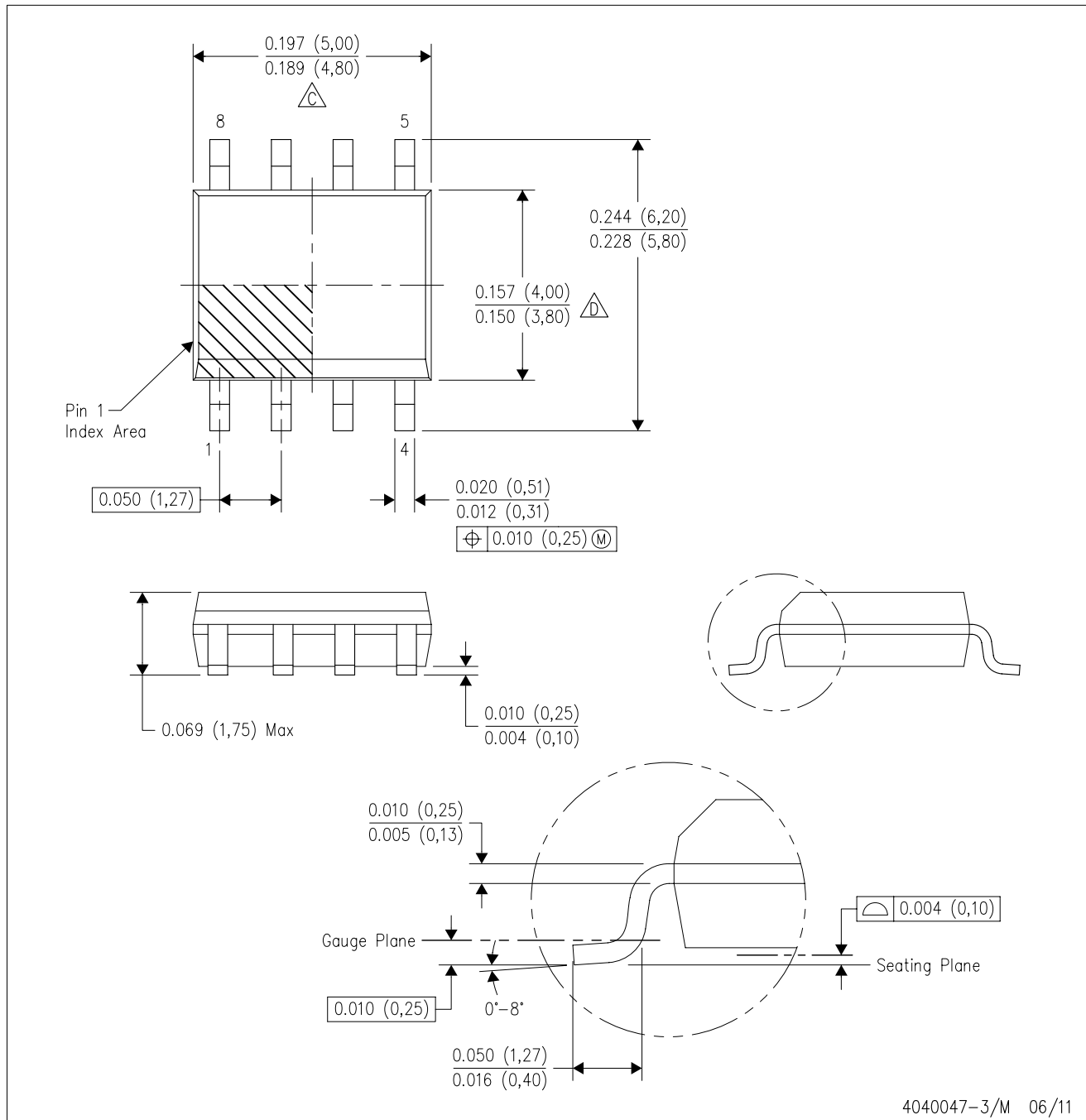

- NOTES:
- A. All linear dimensions are in inches (millimeters).
  - B. This drawing is subject to change without notice.
  - C. Body length does not include mold flash, protrusions, or gate burrs. Mold flash, protrusions, or gate burrs shall not exceed 0.006 (0,15) each side.
  - D. Body width does not include interlead flash. Interlead flash shall not exceed 0.017 (0,43) each side.
  - E. Reference JEDEC MS-012 variation AA.

D (R-PDSO-G8)

PLASTIC SMALL OUTLINE

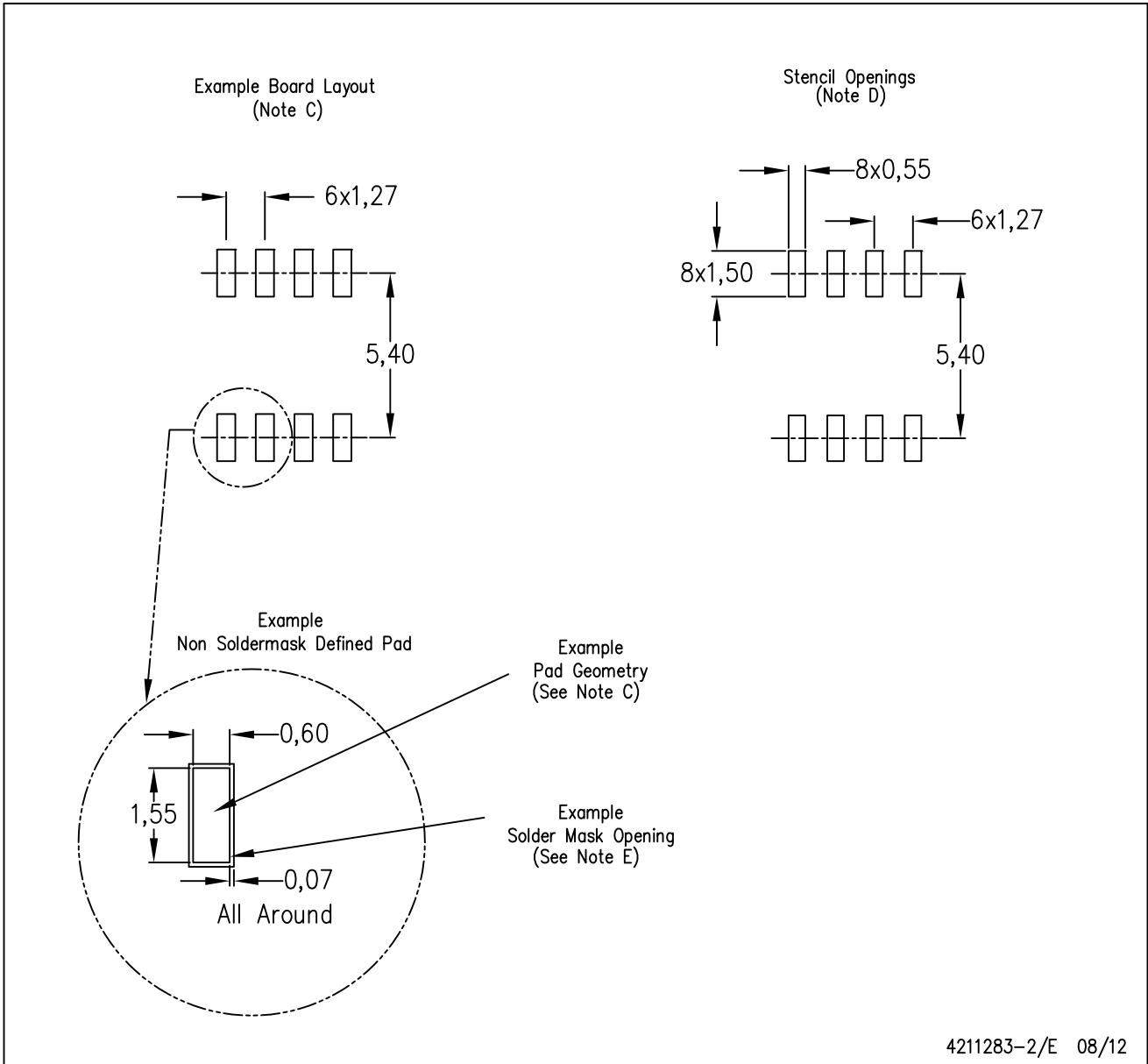

- NOTES:
- All linear dimensions are in millimeters.
  - This drawing is subject to change without notice.
  - Publication IPC-7351 is recommended for alternate designs.
  - Laser cutting apertures with trapezoidal walls and also rounding corners will offer better paste release. Customers should contact their board assembly site for stencil design recommendations. Refer to IPC-7525 for other stencil recommendations.
  - Customers should contact their board fabrication site for solder mask tolerances between and around signal pads.

## IMPORTANT NOTICE

Texas Instruments Incorporated and its subsidiaries (TI) reserve the right to make corrections, enhancements, improvements and other changes to its semiconductor products and services per JESD46, latest issue, and to discontinue any product or service per JESD48, latest issue. Buyers should obtain the latest relevant information before placing orders and should verify that such information is current and complete. All semiconductor products (also referred to herein as "components") are sold subject to TI's terms and conditions of sale supplied at the time of order acknowledgment.

TI warrants performance of its components to the specifications applicable at the time of sale, in accordance with the warranty in TI's terms and conditions of sale of semiconductor products. Testing and other quality control techniques are used to the extent TI deems necessary to support this warranty. Except where mandated by applicable law, testing of all parameters of each component is not necessarily performed.

TI assumes no liability for applications assistance or the design of Buyers' products. Buyers are responsible for their products and applications using TI components. To minimize the risks associated with Buyers' products and applications, Buyers should provide adequate design and operating safeguards.

TI does not warrant or represent that any license, either express or implied, is granted under any patent right, copyright, mask work right, or other intellectual property right relating to any combination, machine, or process in which TI components or services are used. Information published by TI regarding third-party products or services does not constitute a license to use such products or services or a warranty or endorsement thereof. Use of such information may require a license from a third party under the patents or other intellectual property of the third party, or a license from TI under the patents or other intellectual property of TI.

Reproduction of significant portions of TI information in TI data books or data sheets is permissible only if reproduction is without alteration and is accompanied by all associated warranties, conditions, limitations, and notices. TI is not responsible or liable for such altered documentation. Information of third parties may be subject to additional restrictions.

Resale of TI components or services with statements different from or beyond the parameters stated by TI for that component or service voids all express and any implied warranties for the associated TI component or service and is an unfair and deceptive business practice. TI is not responsible or liable for any such statements.

Buyer acknowledges and agrees that it is solely responsible for compliance with all legal, regulatory and safety-related requirements concerning its products, and any use of TI components in its applications, notwithstanding any applications-related information or support that may be provided by TI. Buyer represents and agrees that it has all the necessary expertise to create and implement safeguards which anticipate dangerous consequences of failures, monitor failures and their consequences, lessen the likelihood of failures that might cause harm and take appropriate remedial actions. Buyer will fully indemnify TI and its representatives against any damages arising out of the use of any TI components in safety-critical applications.

In some cases, TI components may be promoted specifically to facilitate safety-related applications. With such components, TI's goal is to help enable customers to design and create their own end-product solutions that meet applicable functional safety standards and requirements. Nonetheless, such components are subject to these terms.

No TI components are authorized for use in FDA Class III (or similar life-critical medical equipment) unless authorized officers of the parties have executed a special agreement specifically governing such use.

Only those TI components which TI has specifically designated as military grade or "enhanced plastic" are designed and intended for use in military/aerospace applications or environments. Buyer acknowledges and agrees that any military or aerospace use of TI components which have **not** been so designated is solely at the Buyer's risk, and that Buyer is solely responsible for compliance with all legal and regulatory requirements in connection with such use.

TI has specifically designated certain components as meeting ISO/TS16949 requirements, mainly for automotive use. In any case of use of non-designated products, TI will not be responsible for any failure to meet ISO/TS16949.

### Products

Audio	<a href="http://www.ti.com/audio">www.ti.com/audio</a>
Amplifiers	<a href="http://amplifier.ti.com">amplifier.ti.com</a>
Data Converters	<a href="http://dataconverter.ti.com">dataconverter.ti.com</a>
DLP® Products	<a href="http://www.dlp.com">www.dlp.com</a>
DSP	<a href="http://dsp.ti.com">dsp.ti.com</a>
Clocks and Timers	<a href="http://www.ti.com/clocks">www.ti.com/clocks</a>
Interface	<a href="http://interface.ti.com">interface.ti.com</a>
Logic	<a href="http://logic.ti.com">logic.ti.com</a>
Power Mgmt	<a href="http://power.ti.com">power.ti.com</a>
Microcontrollers	<a href="http://microcontroller.ti.com">microcontroller.ti.com</a>
RFID	<a href="http://www.ti-rfid.com">www.ti-rfid.com</a>
OMAP Applications Processors	<a href="http://www.ti.com/omap">www.ti.com/omap</a>
Wireless Connectivity	<a href="http://www.ti.com/wirelessconnectivity">www.ti.com/wirelessconnectivity</a>

### Applications

Automotive and Transportation	<a href="http://www.ti.com/automotive">www.ti.com/automotive</a>
Communications and Telecom	<a href="http://www.ti.com/communications">www.ti.com/communications</a>
Computers and Peripherals	<a href="http://www.ti.com/computers">www.ti.com/computers</a>
Consumer Electronics	<a href="http://www.ti.com/consumer-apps">www.ti.com/consumer-apps</a>
Energy and Lighting	<a href="http://www.ti.com/energy">www.ti.com/energy</a>
Industrial	<a href="http://www.ti.com/industrial">www.ti.com/industrial</a>
Medical	<a href="http://www.ti.com/medical">www.ti.com/medical</a>
Security	<a href="http://www.ti.com/security">www.ti.com/security</a>
Space, Avionics and Defense	<a href="http://www.ti.com/space-avionics-defense">www.ti.com/space-avionics-defense</a>
Video and Imaging	<a href="http://www.ti.com/video">www.ti.com/video</a>

### TI E2E Community

[e2e.ti.com](http://e2e.ti.com)

## Looking for pricing, stock, or lifecycle information?

Click below to explore more details on WIN SOURCE:

 [View TLV2462QPWRQ1 on WIN SOURCE](#)

 [Texas Instruments](#) Information

## Optimize Your Supply Chain with WIN SOURCE Solutions

-  Global Sourcing Solution
-  Obsolete Management
-  Cost Control Management
-  Shortage Management
-  Alternative Solution
-  Excess Inventory Management