



Is Now Part of



ON Semiconductor®

To learn more about ON Semiconductor, please visit our website at
www.onsemi.com

Please note: As part of the Fairchild Semiconductor integration, some of the Fairchild orderable part numbers will need to change in order to meet ON Semiconductor's system requirements. Since the ON Semiconductor product management systems do not have the ability to manage part nomenclature that utilizes an underscore (_), the underscore (_) in the Fairchild part numbers will be changed to a dash (-). This document may contain device numbers with an underscore (_). Please check the ON Semiconductor website to verify the updated device numbers. The most current and up-to-date ordering information can be found at www.onsemi.com. Please email any questions regarding the system integration to Fairchild_questions@onsemi.com.

ON Semiconductor and the ON Semiconductor logo are trademarks of Semiconductor Components Industries, LLC dba ON Semiconductor or its subsidiaries in the United States and/or other countries. ON Semiconductor owns the rights to a number of patents, trademarks, copyrights, trade secrets, and other intellectual property. A listing of ON Semiconductor's product/patent coverage may be accessed at www.onsemi.com/site/pdf/Patent-Marking.pdf. ON Semiconductor reserves the right to make changes without further notice to any products herein. ON Semiconductor makes no warranty, representation or guarantee regarding the suitability of its products for any particular purpose, nor does ON Semiconductor assume any liability arising out of the application or use of any product or circuit, and specifically disclaims any and all liability, including without limitation special, consequential or incidental damages. Buyer is responsible for its products and applications using ON Semiconductor products, including compliance with all laws, regulations and safety requirements or standards, regardless of any support or applications information provided by ON Semiconductor. "Typical" parameters which may be provided in ON Semiconductor data sheets and/or specifications can and do vary in different applications and actual performance may vary over time. All operating parameters, including "Typicals" must be validated for each customer application by customer's technical experts. ON Semiconductor does not convey any license under its patent rights nor the rights of others. ON Semiconductor products are not designed, intended, or authorized for use as a critical component in life support systems or any FDA Class 3 medical devices or medical devices with a same or similar classification in a foreign jurisdiction or any devices intended for implantation in the human body. Should Buyer purchase or use ON Semiconductor products for any such unintended or unauthorized application, Buyer shall indemnify and hold ON Semiconductor and its officers, employees, subsidiaries, affiliates, and distributors harmless against all claims, costs, damages, and expenses, and reasonable attorney fees arising out of, directly or indirectly, any claim of personal injury or death associated with such unintended or unauthorized use, even if such claim alleges that ON Semiconductor was negligent regarding the design or manufacture of the part. ON Semiconductor is an Equal Opportunity/Affirmative Action Employer. This literature is subject to all applicable copyright laws and is not for resale in any manner.



24-Bit Low-Power Serializer/Deserializer

Features

Data & Control Bits	24
Frequency	20MHz
Capability	HVGA
Interface	Microcontroller / RGB
µController Usage	186 & m68
Dynamic Current	17mA at 10Mhz
Standby Current	10µA
Core Voltage (V _{DDA/S})	2.5V to 3.3V
I/O Voltage (V _{DDP})	1.65V to 3.6V
ESD	15KV (IEC)
Package	MLP-40 (6 x 6mm)
Ordering Information	FIN224CMLX, MLP-40

Related Resources

- For samples and questions, please contact:
interface@fairchildsemi.com.

Description

The FIN224C µSerDes™ is a low-power serializer/deserializer (µSerDes™) that can help minimize the cost and power of transferring wide signal paths. Through the use of serialization, the number of signals transferred from one point to another can be significantly reduced. Typical reduction is 5:1 for unidirectional paths. Through the use of differential signaling, shielding and EMI filters can also be minimized, further reducing the cost of serialization.

The differential signaling is also important for providing a noise-insensitive signal that can withstand radio and electrical noise sources. Major reduction in power consumption allows minimal impact on battery life in mobile applications. It is possible to use a single Phase-Locked Loop (PLL) for most applications, including bi-directional operation.

Applications

- Slider, Folder, and Clamshell Mobile Handsets
- GSM and CDMA Phones

Typical Application

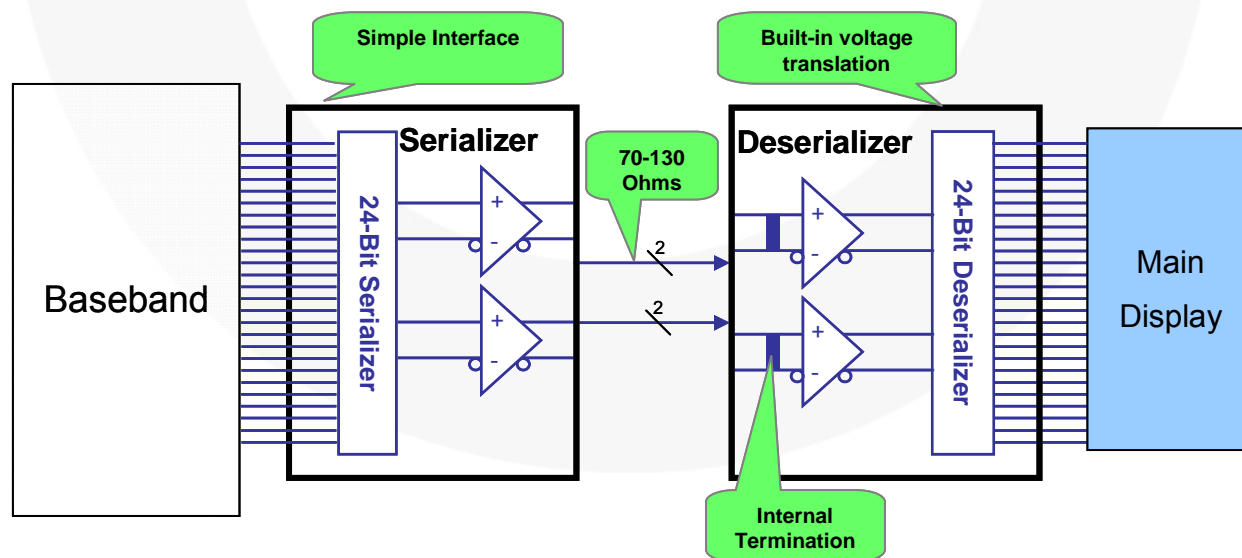

Figure 1. Mobile Phone Example

Pin Configuration

Pin Name	Description		
STROBE	LVC MOS Strobe Signal for Latching Data into the Serializer (On Rising Edge)		
CKREF	LVC MOS Clock Input and PLL Reference		
CKP	LVC MOS Word Clock Output		
DP[24:1]	LVC MOS Data I/O		
/DIRO	LVC MOS Control Output Inversion of DIRI		
S1, S2	LVC MOS Select Pins, Controls the Mode of Operation, see Table 1		
DIRI	LVC MOS Control, Selects Serializer or Deserializer Mode	0	Deserializer
		1	Serializer
DSO+ / DSI- DSO- / DSI+	Serial Data I/O		
CKSI+, CKSI-	Serial Clock Input		
CKSO+, CKSO-	Serial Clock Output		
VDDP	Power Supply for Parallel I/O and Internal Circuitry		
VDDS	Power Supply for Serial I/O		
VDDA	Power Supply for Core		
GND	Ground Pins		

Note:

- 0 = V_{IL} ; 1 = V_{IH} .

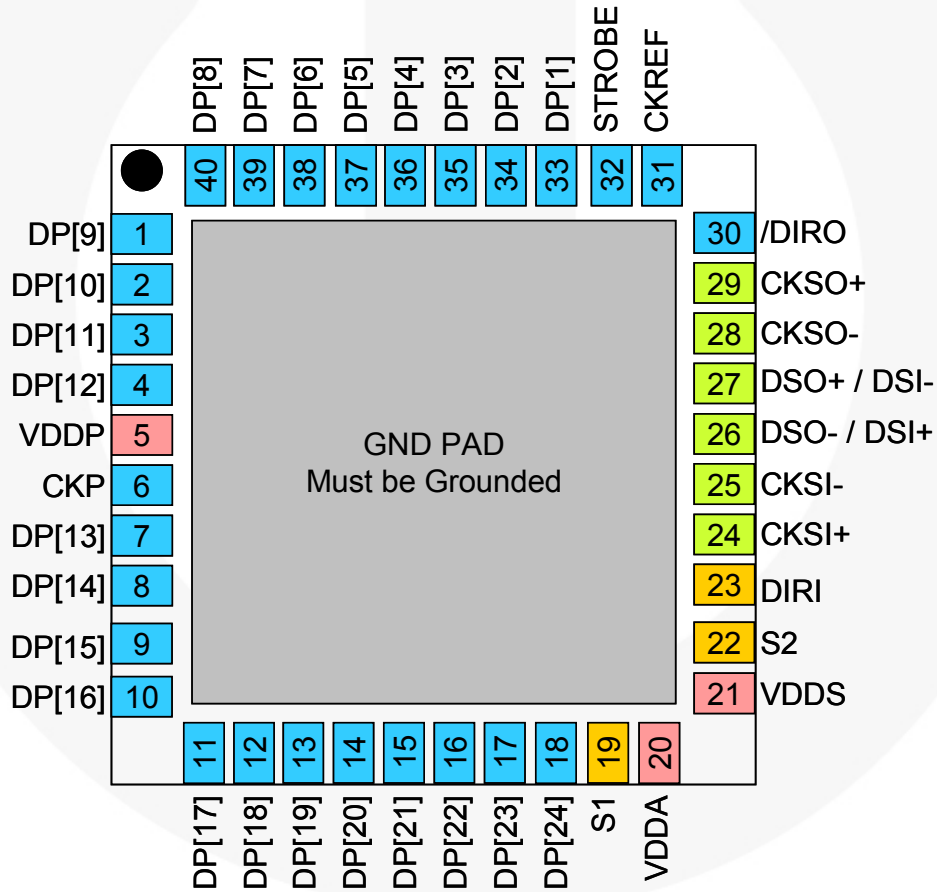

Figure 2. MLP-40 Pinout (Through View)

Table 1. Serializer / Deserializer, Operation, and Reset Modes

DIRI	S1	S2	Mode of Operation
X	0	0	Reset Mode LVCMOS Outputs = High Impedance LVCMOS Inputs = Known State
1	0	1	Serializer Mode
0	1	0	Deserializer Mode

Application Diagrams

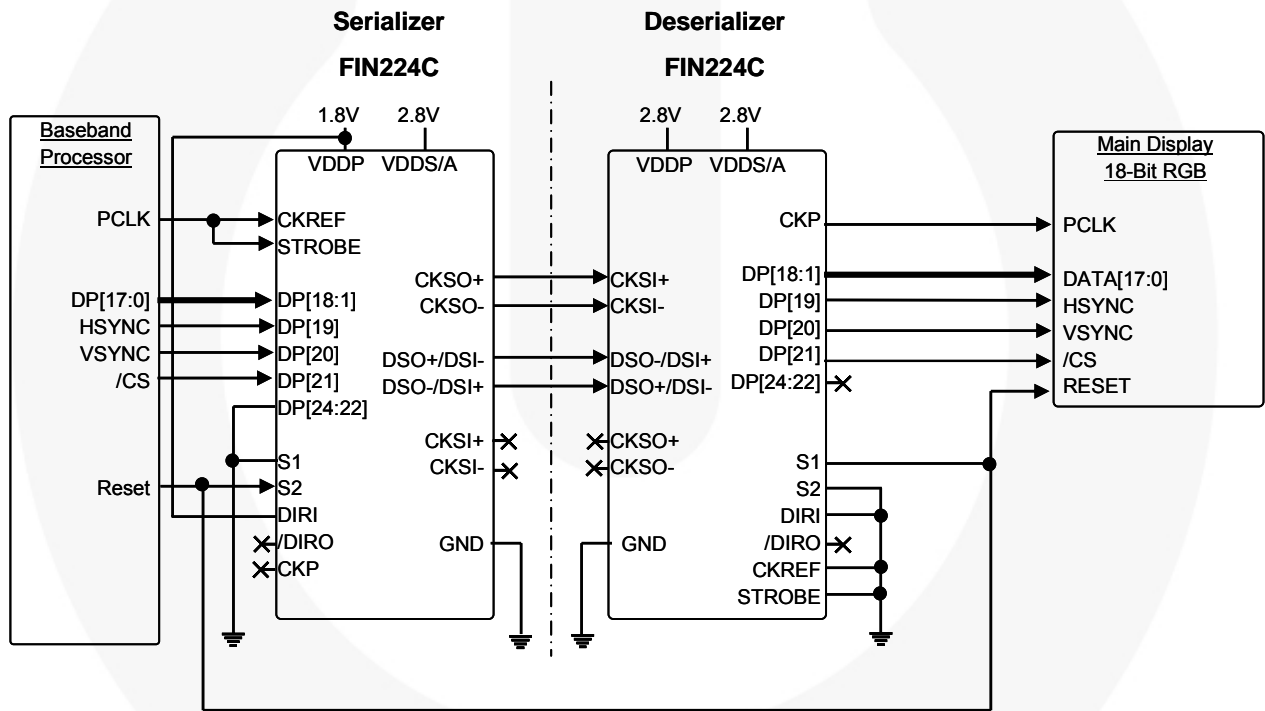

Figure 3. 18-Bit RGB Interface Block Diagram

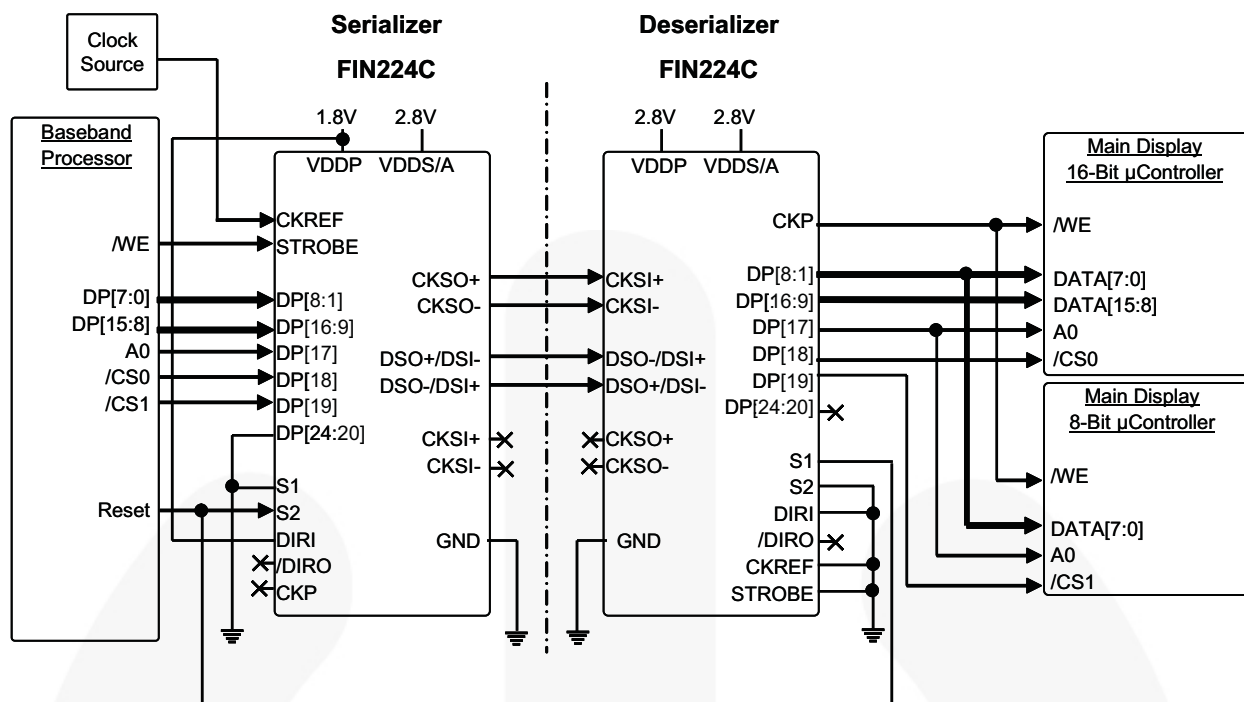

Figure 4. Dual-Display μController Interface Block Diagram

Additional Application Information

Flex Cabling: The serial I/O information is transmitted at a high serial rate. Care must be taken implementing this serial I/O flex cable. The following best practices should be used when developing the flex cabling or Flex PCB.

- Keep all four differential serial wires the same length.
- Do not allow noisy signals over or near differential serial wires. Example: No CMOS traces over differential serial wires.
- Design goal of 70 to 130Ω differential characteristic impedance.
- Do not place test points on differential serial wires.
- Design differential serial wires a minimum of 2cm away from the antenna.
- Visit Fairchild’s website at <http://www.fairchildsemi.com/products/interface/userdes.html>, contact your sales representative, or contact Fairchild directly at interface@fairchildsemi.com for applications notes or flex guidelines.

Absolute Maximum Ratings

Stresses exceeding the absolute maximum ratings may damage the device. The device may not function or be operable above the recommended operating conditions and stressing the parts to these levels is not recommended. In addition, extended exposure to stresses above the recommended operating conditions may affect device reliability. The absolute maximum ratings are stress ratings only.

Symbol	Parameter		Min.	Max.	Unit
V _{DD}	Supply Voltage		-0.5	+4.6	V
	All Input/Output Voltage		-0.5	+4.6	V
T _{STG}	Storage Temperature Range		-65	+150	°C
T _J	Maximum Junction Temperature			+150	°C
T _L	Lead Temperature (Soldering, 4 Seconds)			+260	°C
ESD	IEC 61000 Board Level			15.0	kV
	Human Body Model, JESD22-A114	All Pins		2.5	
		Serial I/O, /RES, PAR/SPI to GND		8.0	

Recommended Operating Conditions

The Recommended Operating Conditions table defines the conditions for actual device operation. Recommended operating conditions are specified to ensure optimal performance to the datasheet specifications. Fairchild does not recommend exceeding them or designing to absolute maximum ratings.

Symbol	Parameter	Min.	Max.	Unit
V _{DDA} , V _{DDS} ⁽¹⁾	Supply Voltage	2.5	3.3	V
V _{DDP}	Supply Voltage	1.65	3.60	V
T _A	Operating Temperature	-30	+70	°C







Note:

- V_{DDA} and V_{DDS} supplies must be hardwired together to the same power supply.

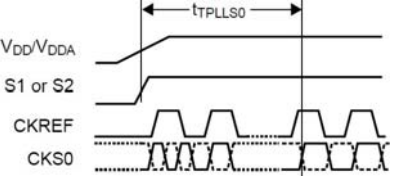
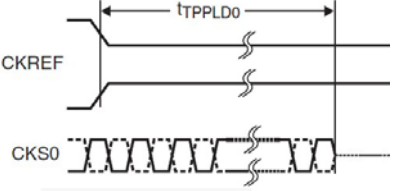
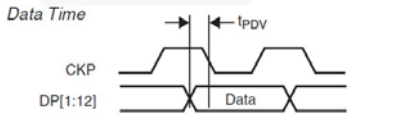
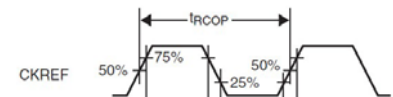
Electrical Specifications

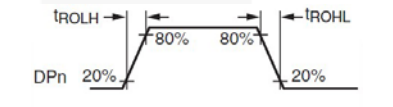
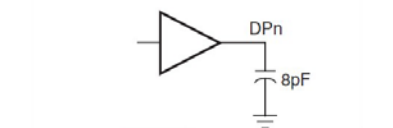
Values valid for over supply voltage and operating temperature ranges unless otherwise specified. Typical values are tested at $T_A = 25^\circ\text{C}$ and $V_{DD} = 2.775\text{V}$.

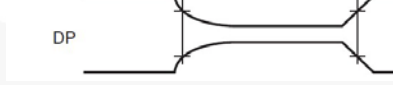
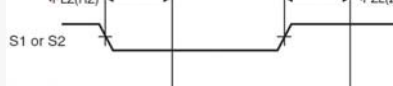
Symbol	Parameter	Test Conditions	Min.	Typ.	Max.	Unit
DC Parallel I/O Characteristics						
V_{IH}	Input High Voltage		$0.65 \times V_{DDP}$		V_{DDP}	V
V_{IL}	Input Low Voltage		GND		$0.35 \times V_{DDP}$	V
V_{OH}	Output High Voltage	$I_{OH} = -2.0\text{mA}$	$V_{DDP} = 3.3 \pm 0.30\text{V}$	0.75 x V_{DDP}		V
			$V_{DDP} = 2.5 \pm 0.20\text{V}$			
			$V_{DDP} = 1.8 \pm 0.18\text{V}$			
V_{OL}	Output Low Voltage	$I_{OH} = -2.0\text{mA}$	$V_{DDP} = 3.3 \pm 0.30\text{V}$		0.25 x V_{DDP}	V
			$V_{DDP} = 2.5 \pm 0.20\text{V}$			
			$V_{DDP} = 1.8 \pm 0.18\text{V}$			
I_{IN}	Input Current		-5		5	μA
DC Serial Characteristics						
I_{ODH}	Output High Source Current			-1.75		mA
I_{ODL}	Output Low Source Current			0.95		mA
I_{OZ}	Disabled Output Leakage Current	CKSO, DSO = 0V to V_{DDs} , S2 = S1 = 0V		± 1	± 5	μA
I_{IZ}	Disabled Input Leakage Current	CKSO, DSO = 0V to V_{DDs} , S2 = S1 = 0V		± 1	± 5	
R_{TRM}	CKSI, DS Internal Receiver Termination Resistor			100		Ω
Z	Serial Transmission Line Impedance		70	100	130	Ω
Power Characteristics						
I_{DDA}/S_{SER}	V_{DDA} , V_{DDs} Serializer Static Current	All DP and Control Inputs at 0V or No CKREF, DIRI = 1		4.5		mA
I_{DDA}/S_{DES}	V_{DDA} , V_{DDs} Deserializer Static Current	All DP and Control Inputs at 0V or No CKREF, DIRI = 0		5		mA
I_{DDSER}	Dynamic Serializer Current $I_{DDSER} = I_{DDA} + I_{DDs} + I_{DDP}$	CKREF = STROBE, DIRI = 1	10MHz	11		mA
			20MHz	15		mA
I_{DDDES}	Dynamic Deserializer Current $I_{DDDES} = I_{DDA} + I_{DDs} + I_{DDP}$	CKREF = STROBE, DIRI = 0	10MHz	7		mA
			20MHz	10		mA
I_{DD_PD}	V_{DD} Power-Down Current $I_{DD_PD} = I_{DDA} + I_{DDs} + I_{DDP}$	S1 = S2 = 0 All Inputs at GND or V_{DD}		0.1		μA
AC Serializer, DIRI = 1 Specifications						
f_{MAX}	Maximum CKREF Frequency		2		20	MHz
f_{REF}	CKREF Frequency Relative to STROBE		$1.1 \times f_{STROBE}$		20	MHz
t_{CPWH}	CKREF Clock HIGH Time		0.2	0.5		T
t_{CPWL}	CKREF Clock LOW Time		0.2	0.5		T
t_{CLKT}	LVC MOS Input Transition Time				90	ns
t_{SPWH}	STROBE Pulse Width HIGH/LOW		$(Tx4) / 26$		$(Tx22) / 26$	ns
t_{STC}	DP[n] Setup to STROBE		2.5			ns
t_{HTC}	DP[n] Hold to STROBE		2.0			ns

Symbol	Parameter	Test Conditions	Min.	Typ.	Max.	Unit
t_{PLLS0}	Phase Lock Loop Stabilization Time				200	µs
t_{PPLD0}	PLL Disable Time Loss of Clock				30	µs
AC Deserializer, DIR1 = 0 Specifications						
t_{SKEW_DS-CKS}	Allowed DS-CKS Input Signal Skew		-150		150	ps
t_{RCOH}	CKP Out Low Time		13a-3		13a+3	ns
t_{RCOH}	CKP Out High Time		13a-3		13a+13	ns
t_{PDV}	Data Valid to CKP Low	 CKREF = STROBE, a = (1/f)/13	8a-6		8a+1	ns
t_{ROLH}	Output Rise Time (20% to 80%)			18		ns
t_{ROLH}	Output Fall Time (20% to 80%)			18		ns
AC Enable and Disable Timing						
$t_{PLZ(HZ)}$	Deserializer Disable Time				25	ns
$t_{PZL(ZH)}$	Deserializer Enable Time				2	µs
$t_{PLZ(HZ)}$	Serializer Disable Time				25	ns
$t_{PZL(ZH)}$	Serializer Enable Time				65	ns

Notes:

- Skew is measured from either the rising or falling edge of CKS0 clock to the rising or falling edge of DSO. Signals are edge aligned. Both outputs should have identical load conditions for this test to be valid.
- If CKREF is not equal to STROBE for the serializer, the CKP signal does not maintain a 50% duty cycle. The low time of CKP remains 13 bit times.

Physical Dimensions

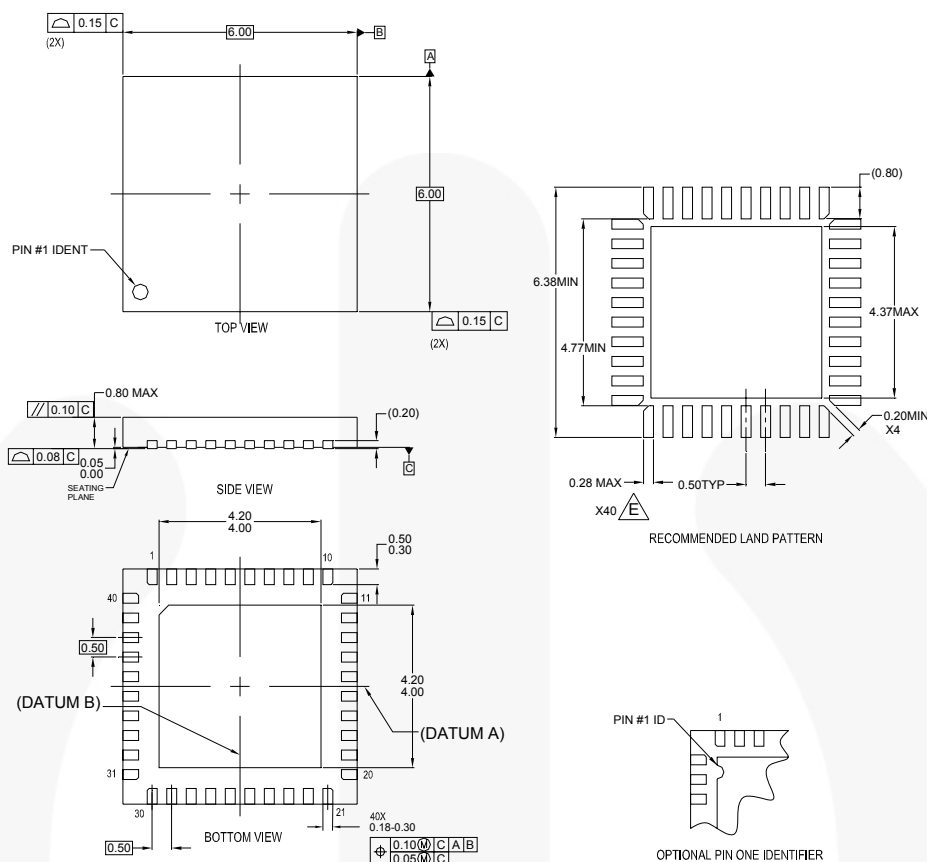

NOTES:

- A. CONFORMS TO JEDEC REGISTRATION MO-220, VARIATION WJJD-2 WITH EXCEPTION THAT THIS IS A SAWN VERSION..
- B. DIMENSIONS ARE IN MILLIMETERS.
- C. DIMENSIONS AND TOLERANCES PER ASME Y14.5M-1994.
- D. LAND PATTERN PER IPC SM-782.
- E. WIDTH REDUCED TO AVOID SOLDER BRIDGING.
- F. DIMENSIONS ARE NOT INCLUSIVE OF BURRS, MOLD FLASH, OR TIE BAR PROTRUSIONS.
- G. DRAWING FILENAME: MKT-MLP40Arev3.

Figure 6. 40-Lead, Molded Leadless Package (MLP), Quad, JEDEC MO-220, 6mm Square

Package drawings are provided as a service to customers considering Fairchild components. Drawings may change in any manner without notice. Please note the revision and/or date on the drawing and contact a Fairchild Semiconductor representative to verify or obtain the most recent revision. Package specifications do not expand the terms of Fairchild's worldwide terms and conditions, specifically the warranty therein, which covers Fairchild products.

Always visit Fairchild Semiconductor's online packaging area for the most recent package drawings: <http://www.fairchildsemi.com/packaging/>.

For current tape and reel specifications, visit Fairchild Semiconductor's online packaging area: <http://www.fairchildsemi.com/packaging/MLP40A.html>

Ordering Information

Part Number	Operating Temperature Range	Eco Status	Package	Packing Method
FIN224CMLX	-30 to +70°C	Green	40-Lead, Molded Leadless Package (MLP), Quad, JEDEC MO-220, 6mm Square	Tape & Reel

For Fairchild's definition of Eco Status, please visit: http://www.fairchildsemi.com/company/green/rohs_green.html.



TRADEMARKS

The following includes registered and unregistered trademarks and service marks, owned by Fairchild Semiconductor and/or its global subsidiaries, and is not intended to be an exhaustive list of all such trademarks.

- | | | | |
|--------------------------|------------------------|---------------------------------------|--|
| AccuPower™ | FlashWriter®* | Power-SPM™ | <p>SYSTEM GENERAL®
The Power Franchise®
the power franchise
TinyBoost™
TinyBuck™
TinyCalc™
TinyLogic®
TINYOPTO™
TinyPower™
TinyPWM™
TinyWire™
TriFault Detect™
TRUECURRENT™*
μSerDes™
 SerDes™
UHC®
Ultra FRFET™
UniFET™
VCX™
VisualMax™
XS™</p> |
| Auto-SPM™ | FPST™ | PowerTrench® | |
| Build it Now™ | F-PFS™ | PowerXS™ | |
| CorePLUS™ | FRFET® | Programmable Active Droop™ | |
| CorePOWER™ | Global Power Resource™ | QFET® | |
| CROSSVOLT™ | Green FPST™ | QS™ | |
| CTL™ | Green FPST™ e-Series™ | Quiet Series™ | |
| Current Transfer Logic™ | Gmax™ | RapidConfigure™ | |
| EcoSPARK® | GTO™ | ™ | |
| EfficientMax™ | IntelliMAX™ | Saving our world, 1mW/W/KW at a time™ | |
| EZSWITCH™* | ISOPLANAR™ | SignalWise™ | |
| ™* | MegaBuck™ | SmartMax™ | |
| DEUXPEED™ | MICROCOUPLER™ | SMART START™ | |
| ™ | MicroFET™ | SPM® | |
| Fairchild® | MicroPak™ | STEALTH™ | |
| Fairchild Semiconductor® | MillerDrive™ | SuperFET™ | |
| FACT Quiet Series™ | MotionMax™ | SuperSOT™-3 | |
| FACT™ | Motion-SPM™ | SuperSOT™-6 | |
| FAST® | OPTOLOGIC® | SuperSOT™-8 | |
| FastvCore™ | OPTOPLANAR® | SupreMOS™ | |
| FETBench™ | ™ | SyncFET™ | |
| | PDP SPM™ | Sync-Lock™ | |

* Trademarks of System General Corporation, used under license by Fairchild Semiconductor.

DISCLAIMER

FAIRCHILD SEMICONDUCTOR RESERVES THE RIGHT TO MAKE CHANGES WITHOUT FURTHER NOTICE TO ANY PRODUCTS HEREIN TO IMPROVE RELIABILITY, FUNCTION, OR DESIGN. FAIRCHILD DOES NOT ASSUME ANY LIABILITY ARISING OUT OF THE APPLICATION OR USE OF ANY PRODUCT OR CIRCUIT DESCRIBED HEREIN; NEITHER DOES IT CONVEY ANY LICENSE UNDER ITS PATENT RIGHTS, NOR THE RIGHTS OF OTHERS. THESE SPECIFICATIONS DO NOT EXPAND THE TERMS OF FAIRCHILD'S WORLDWIDE TERMS AND CONDITIONS, SPECIFICALLY THE WARRANTY THEREIN, WHICH COVERS THESE PRODUCTS.

LIFE SUPPORT POLICY

FAIRCHILD'S PRODUCTS ARE NOT AUTHORIZED FOR USE AS CRITICAL COMPONENTS IN LIFE SUPPORT DEVICES OR SYSTEMS WITHOUT THE EXPRESS WRITTEN APPROVAL OF FAIRCHILD SEMICONDUCTOR CORPORATION.

As used herein:

1. Life support devices or systems are devices or systems which, (a) are intended for surgical implant into the body or (b) support or sustain life, and (c) whose failure to perform when properly used in accordance with instructions for use provided in the labeling, can be reasonably expected to result in a significant injury of the user.
2. A critical component in any component of a life support, device, or system whose failure to perform can be reasonably expected to cause the failure of the life support device or system, or to affect its safety or effectiveness.

ANTI-COUNTERFEITING POLICY

Fairchild Semiconductor Corporation's Anti-Counterfeiting Policy. Fairchild's Anti-Counterfeiting Policy is also stated on our external website, www.fairchildsemi.com, under Sales Support.

Counterfeiting of semiconductor parts is a growing problem in the industry. All manufacturers of semiconductor products are experiencing counterfeiting of their parts. Customers who inadvertently purchase counterfeit parts experience many problems such as loss of brand reputation, substandard performance, failed applications, and increased cost of production and manufacturing delays. Fairchild is taking strong measures to protect ourselves and our customers from the proliferation of counterfeit parts. Fairchild strongly encourages customers to purchase Fairchild parts either directly from Fairchild or from Authorized Fairchild Distributors who are listed by country on our web page cited above. Products customers buy either from Fairchild directly or from Authorized Fairchild Distributors are genuine parts, have full traceability, meet Fairchild's quality standards for handling and storage and provide access to Fairchild's full range of up-to-date technical and product information. Fairchild and our Authorized Distributors will stand behind all warranties and will appropriately address any warranty issues that may arise. Fairchild will not provide any warranty coverage or other assistance for parts bought from Unauthorized Sources. Fairchild is committed to combat this global problem and encourage our customers to do their part in stopping this practice by buying direct or from authorized distributors.

PRODUCT STATUS DEFINITIONS

Definition of Terms

Datasheet Identification	Product Status	Definition
Advance Information	Formative / In Design	Datasheet contains the design specifications for product development. Specifications may change in any manner without notice.
Preliminary	First Production	Datasheet contains preliminary data; supplementary data will be published at a later date. Fairchild Semiconductor reserves the right to make changes at any time without notice to improve design.
No Identification Needed	Full Production	Datasheet contains final specifications. Fairchild Semiconductor reserves the right to make changes at any time without notice to improve the design.
Obsolete	Not In Production	Datasheet contains specifications on a product that is discontinued by Fairchild Semiconductor. The datasheet is for reference information only.

Rev. I43

ON Semiconductor and  are trademarks of Semiconductor Components Industries, LLC dba ON Semiconductor or its subsidiaries in the United States and/or other countries. ON Semiconductor owns the rights to a number of patents, trademarks, copyrights, trade secrets, and other intellectual property. A listing of ON Semiconductor's product/patent coverage may be accessed at www.onsemi.com/site/pdf/Patent-Marking.pdf. ON Semiconductor reserves the right to make changes without further notice to any products herein. ON Semiconductor makes no warranty, representation or guarantee regarding the suitability of its products for any particular purpose, nor does ON Semiconductor assume any liability arising out of the application or use of any product or circuit, and specifically disclaims any and all liability, including without limitation special, consequential or incidental damages. Buyer is responsible for its products and applications using ON Semiconductor products, including compliance with all laws, regulations and safety requirements or standards, regardless of any support or applications information provided by ON Semiconductor. "Typical" parameters which may be provided in ON Semiconductor data sheets and/or specifications can and do vary in different applications and actual performance may vary over time. All operating parameters, including "Typicals" must be validated for each customer application by customer's technical experts. ON Semiconductor does not convey any license under its patent rights nor the rights of others. ON Semiconductor products are not designed, intended, or authorized for use as a critical component in life support systems or any FDA Class 3 medical devices or medical devices with a same or similar classification in a foreign jurisdiction or any devices intended for implantation in the human body. Should Buyer purchase or use ON Semiconductor products for any such unintended or unauthorized application, Buyer shall indemnify and hold ON Semiconductor and its officers, employees, subsidiaries, affiliates, and distributors harmless against all claims, costs, damages, and expenses, and reasonable attorney fees arising out of, directly or indirectly, any claim of personal injury or death associated with such unintended or unauthorized use, even if such claim alleges that ON Semiconductor was negligent regarding the design or manufacture of the part. ON Semiconductor is an Equal Opportunity/Affirmative Action Employer. This literature is subject to all applicable copyright laws and is not for resale in any manner.

PUBLICATION ORDERING INFORMATION

LITERATURE FULFILLMENT:

Literature Distribution Center for ON Semiconductor
19521 E. 32nd Pkwy, Aurora, Colorado 80011 USA
Phone: 303-675-2175 or 800-344-3860 Toll Free USA/Canada
Fax: 303-675-2176 or 800-344-3867 Toll Free USA/Canada
Email: orderlit@onsemi.com

N. American Technical Support: 800-282-9855 Toll Free
USA/Canada
Europe, Middle East and Africa Technical Support:
Phone: 421 33 790 2910
Japan Customer Focus Center
Phone: 81-3-5817-1050

ON Semiconductor Website: www.onsemi.com
Order Literature: <http://www.onsemi.com/orderlit>
For additional information, please contact your local
Sales Representative

Looking for pricing, stock, or lifecycle information?

Click below to explore more details on WIN SOURCE:

- ⊖ [View FIN224CMLX on WIN SOURCE](#)
- ⊖ [Fairchild/ON Semiconductor Information](#)

Optimize Your Supply Chain with WIN SOURCE Solutions

- ✓ Global Sourcing Solution
- ✓ Obsolete Management
- ✓ Cost Control Management
- ✓ Shortage Management
- ✓ Alternative Solution
- ✓ Excess Inventory Management