

ORANGE MV5153/4A MV6153/4A
YELLOW MV5353/4A MV6353/4A
HIGH EFFICIENCY GREEN MV5453/4A MV64530/1 MV6454A
HIGH EFFICIENCY RED MV5753/4A MV6753/4A

PACKAGE DIMENSIONS

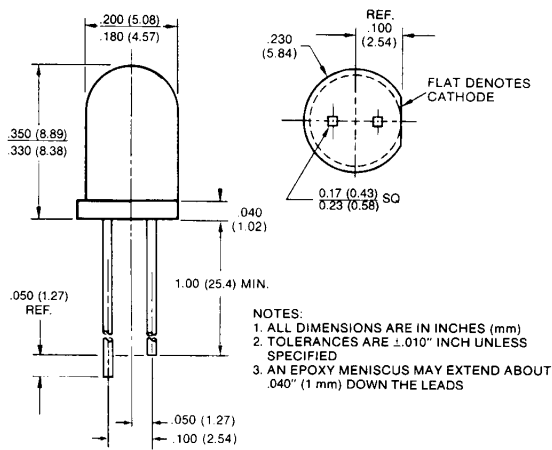

C1062L

DESCRIPTION

These solid state indicators offer a variety of diffused lens effects and color availability. The High Efficiency Red and Yellow devices are made with gallium arsenide phosphide on gallium phosphide. The Green units are made with gallium phosphide on gallium phosphide. All devices are available with cathode long as MV5X5X, or with anode long as MV6X5X.

FEATURES

- High efficiency GaP light source with various lens effects
- Versatile mounting on PC board or panel
- Snap in grommet MP52 available as separate order item
- Long life—solid state reliability
- Low power requirements
- Compact, rugged, lightweight

PHYSICAL CHARACTERISTICS

CATHODE LONG	ANODE LONG	SOURCE COLOR	LENS TYPE	LENS EFFECT	APPLICATION
MV5153	MV6153	High Efficiency Red	Amber Diffused	Wide Beam	Direct View
MV5154A	MV6154A	High Efficiency Red	Amber Diffused	Narrow Beam	High Bright Direct View
MV5353	MV6353	Yellow	Yellow Diffused	Wide Beam	Direct View
MV5354A	MV6354A	Yellow	Yellow Diffused	Narrow Beam	High Bright Direct View
MV5453	MV64530/1	High Efficiency Green	Green Diffused	Wide Beam	Direct View
MV5454A	MV6454A	High Efficiency Green	Green Diffused	Narrow Beam	High Bright Direct View
MV5753	MV6753	High Efficiency Red	Red Diffused	Wide Beam	Direct View
MV5754A	MV6754A	High Efficiency Red	Red Diffused	Narrow Beam	High Bright Direct View

ELECTRO-OPTICAL CHARACTERISTICS (25°C Free Air Temperature)												
PARAMETER	TEST COND.	UNITS	6153 5153	6154A 5154A	6353 5353	6354A 5354A	64530 5453	64531	6454A 5454A	6753 5753	6754A 5754A	
Forward voltage (V _f)	typ.	I _f =20 mA	V	2.0	2.0	2.1	2.1	2.2	2.2	2.2	2.0	2.0
	max.	I _f =20 mA	V	3.0	3.0	3.0	3.0	3.0	3.0	3.0	3.0	3.0
Luminous Intensity	min.	I _f =20 mA	mcd	3.0	10.0	2.5	10.0	3.0	7.0	10.0	3.0	10.0
	typ.	I _f =20 mA	mcd	15	25	15	25	20	20	30	15	25
Peak wavelength	I _f =20 mA	nm	635	635	585	585	562	562	562	635	635	
Spectral line half width	I _f =20 mA	nm	45	45	35	35	30	30	30	45	45	
Capacitance typ.	V=0, f=1 MHz	pF	45	45	45	45	20	20	20	45	45	
Reverse voltage (V _r) min.	I _r =100 μA	V	5	5	5	5	5	5	5	5	5	
Reverse current (I _r) max.	V _r =5.0 V	μA	100	100	100	100	100	100	100	100	100	
Viewing angle (total)	See Fig. 3	degrees	65	24	65	24	75	75	24	65	24	

ABSOLUTE MAXIMUM RATINGS (T _A =25°C Unless Otherwise Specified)			
	YELLOW	H.E. RED, ORANGE	GREEN
Power dissipation at 25°C ambient	85 mW	120 mW	120 mW
Derate linearly from 25°C (MVX453/4A from 50°C)	1.6 mW/°C	1.6 mW/°C	1.6 mW/°C
Storage and operating temperatures	-55°C to +100°C	-55°C to +100°C	-55°C to +100°C
Lead soldering time at 260°C (See Note 2)	5 sec.	5 sec.	5 sec.
Continuous forward current at 25°C	20 mA	35 mA	30 mA
Peak forward current (1 μsec pulse, 0.3% duty cycle)	60 mA	1.0 A	90 mA
Reverse voltage	5.0 V	5.0 V	5.0 V

NOTES
1. The axis of spatial distribution are typically within a 10° cone with reference to the central axis of the device.
2. The leads of the device were immersed in molten solder, at 260°C, to a point 1/16 inch (1.6 mm) from the body of the device per MIL-S-750, with a dwell time of 5 seconds.

TYPICAL ELECTRO-OPTICAL CHARACTERISTIC CURVES
(25°C Free Air Temperature Unless Otherwise Specified)

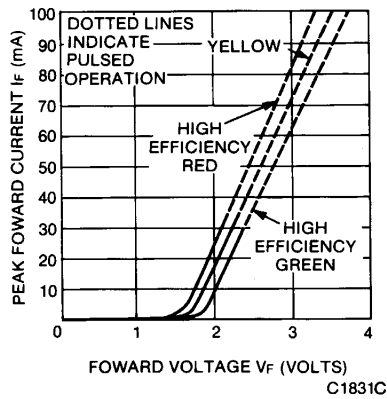

Fig. 1. Forward Current vs. Forward Voltage

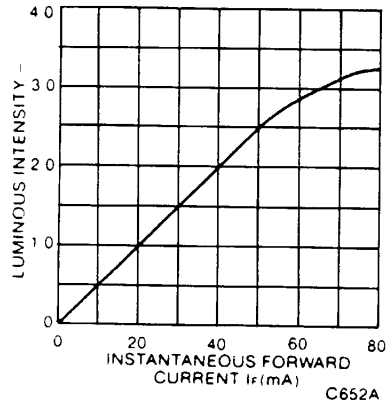

Fig. 2. Luminous Intensity vs. Forward Current

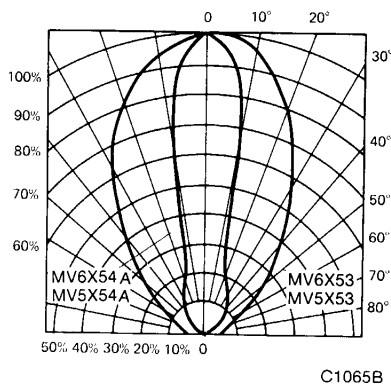

Fig. 3. Spatial Distribution
(See Note 1)

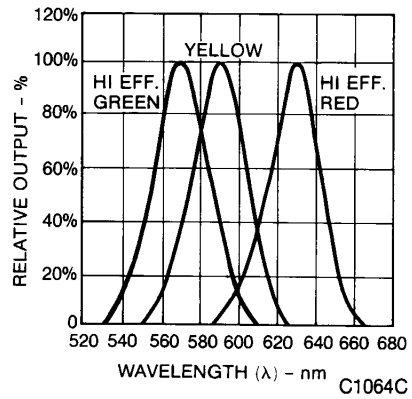

Fig. 4. Spectral Distribution



DIFFUSED T-1 3/4 SOLID STATE LAMPS

DISCLAIMER

FAIRCHILD SEMICONDUCTOR RESERVES THE RIGHT TO MAKE CHANGES WITHOUT FURTHER NOTICE TO ANY PRODUCTS HEREIN TO IMPROVE RELIABILITY, FUNCTION OR DESIGN. FAIRCHILD DOES NOT ASSUME ANY LIABILITY ARISING OUT OF THE APPLICATION OR USE OF ANY PRODUCT OR CIRCUIT DESCRIBED HEREIN; NEITHER DOES IT CONVEY ANY LICENSE UNDER ITS PATENT RIGHTS, NOR THE RIGHTS OF OTHERS.



LIFE SUPPORT POLICY

FAIRCHILD'S PRODUCTS ARE NOT AUTHORIZED FOR USE AS CRITICAL COMPONENTS IN LIFE SUPPORT DEVICES OR SYSTEMS WITHOUT THE EXPRESS WRITTEN APPROVAL OF THE PRESIDENT OF FAIRCHILD SEMICONDUCTOR CORPORATION. As used herein:

1. Life support devices or systems are devices or systems which, (a) are intended for surgical implant into the body, or (b) support or sustain life, and (c) whose failure to perform when properly used in accordance with instructions for use provided in the labeling, can be reasonably expected to result in a significant injury of the user.
2. A critical component in any component of a life support device or system whose failure to perform can be reasonably expected to cause the failure of the life support device or system, or to affect its safety or effectiveness.

Looking for pricing, stock, or lifecycle information?

Click below to explore more details on WIN SOURCE:

-  [View MV5454A on WIN SOURCE](#)
-  [Everlight Electronics Co Ltd Information](#)

Optimize Your Supply Chain with WIN SOURCE Solutions

-  Global Sourcing Solution
-  Obsolete Management
-  Cost Control Management
-  Shortage Management
-  Alternative Solution
-  Excess Inventory Management