



# THE DATASHEET OF MAX479CPD



## **Not Recommended for New Designs**

---

This product was manufactured for Maxim by an outside wafer foundry using a process that is no longer available. It is not recommended for new designs. The data sheet remains available for existing users.

A Maxim replacement or an industry second-source may be available. Please see the QuickView data sheet for this part or contact technical support for assistance.

For further information, [contact Maxim's Applications Tech Support](#).



# 17µA Max, Dual/Quad, Single-Supply, Precision Op Amps

MAX478/MAX479

## General Description

The MAX478 and MAX479 are dual and quad micro-power, precision op amps available in 8-pin and 14-pin DIP and small-outline packages, respectively. Both devices feature an extremely low, 17 µA max supply current per op amp, 70µV max offset voltage, 2.2µV/°C max offset voltage drift (0.5µV/°C typ), and 250pA max input offset current.

The MAX478 and MAX479 operate from a single supply. The input voltage range includes ground, and the output swings to within a few millivolts of ground, which eliminates pull-down resistors and saves power.

Both devices are optimized for single 3V and 5V supply operation, with guaranteed specifications at each supply voltage. Specifications for ±15V operation are also provided.

## Applications

Battery- or Solar-Powered Systems:

- Portable Instrumentation
- Remote Sensor Amplifier
- Satellite Circuitry

Micropower Sample-and-Hold

Thermocouple Amplifier

Micropower Filters

Single Lithium Cell Powered Systems

## Typical Operating Circuit

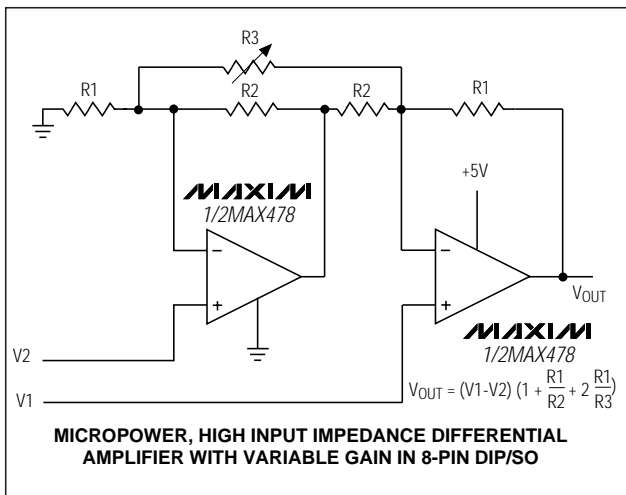

## Features

- ◆ 17µA Max Supply Current (MAX478A/MAX479A)
- ◆ 70µV Max Offset Voltage (MAX478A)
- ◆ Single-Supply Operation:
  - Input Voltage Range Includes Ground
  - Output Swings to Ground While Sinking Current
  - No Pull-Down Resistors Required
- ◆ Dual Op Amp in 8-Pin DIP/SO Package (MAX478)  
Quad Op Amp in 14-Pin DIP/SO Package (MAX479)
- ◆ 250pA Max Input Offset Current (MAX478A/MAX479A)
- ◆ 0.5µV/°C Offset-Voltage Drift
- ◆ Output Sources and Sinks 5mA Load Current

## Ordering Information

PART	TEMP. RANGE	PIN-PACKAGE
MAX478ACPA	0°C to +70°C	8 Plastic DIP
MAX478CPA	0°C to +70°C	8 Plastic DIP
MAX478CSA	0°C to +70°C	8 SO
MAX478C/D	0°C to +70°C	Dice*
MAX478EPA	-40°C to +85°C	8 Plastic DIP
MAX478ESA	-40°C to +85°C	8 SO
MAX479ACPD	0°C to +70°C	14 Plastic DIP
MAX479CPD	0°C to +70°C	14 Plastic DIP
MAX479CSD	0°C to +70°C	14 SO
MAX479EPD	-40°C to +85°C	14 Plastic DIP
MAX479ESD	-40°C to +85°C	14 SO

\* Dice are specified at  $T_A = +25^\circ\text{C}$ , DC parameters only.

## Pin Configurations

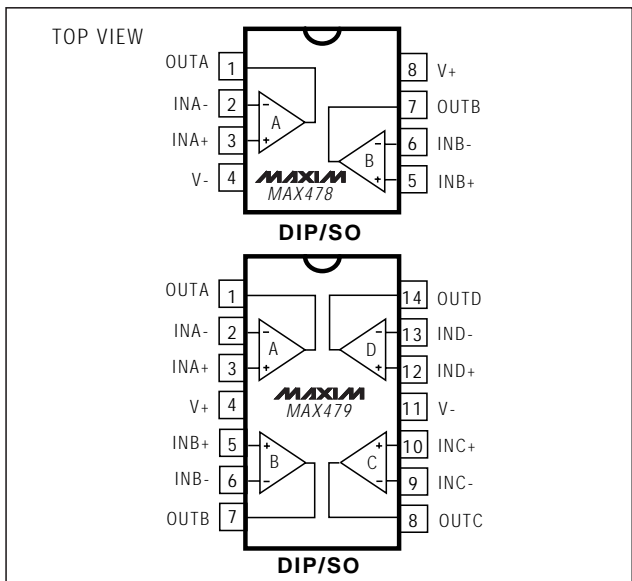



# 17μA Max, Dual/Quad, Single-Supply, Precision Op Amps

MAX478/MAX479

## ELECTRICAL CHARACTERISTICS: 5V (continued)

( $V_S = 5V$ ,  $0V$ ,  $V_{CM} = 0.1V$ ,  $V_O = 1.4V$ ,  $T_A = +25^\circ C$ , unless otherwise noted.)

PARAMETER	SYMBOL	CONDITIONS	MAX478AC MAX479AC			MAX478C/E MAX479C/E			UNITS
			MIN	TYP	MAX	MIN	TYP	MAX	
Output Voltage Swing	$V_{OUT}$	Output low, no load	6.5	9.0		6.5	9.0	mV	
		Output low, 2kΩ to GND	0.2	0.6		0.2	0.6		
		Output low, $I_{SINK} = 100\mu A$	120	160		120	160		
		Output high, no load	4.2	4.4		4.2	4.4	V	
		Output high, 2kΩ to GND	3.5	3.8		3.5	3.8		
Slew Rate	SR	$A_V = +1$ , $C_L = 1pF$ (Note 1)	0.013	0.025		0.013	0.025	V/μs	
Gain-Bandwidth Product	GBW	$f_O \leq 5kHz$		60			60	kHz	
Supply Current per Amplifier	$I_S$			13	18		14	21	μA
		$V_S = \pm 1.5V$ , $V_O = 0V$		12	17		13	20	
Channel Separation		$\Delta V_{IN} = 3V$ , $R_L = 10k\Omega$		130			130	dB	
Minimum Supply Voltage	$V_S$	(Note 2)		2.0	2.2		2.0	2.2	V

## ELECTRICAL CHARACTERISTICS: 5V

( $V_S = 5V$ ,  $0V$ ,  $V_{CM} = 0.1V$ ,  $V_O = 1.4V$ ,  $T_A = 0^\circ C$  to  $+70^\circ C$ , unless otherwise noted.)

PARAMETER	SYMBOL	CONDITIONS	MAX478AC MAX479AC			MAX478C MAX479C			UNITS
			MIN	TYP	MAX	MIN	TYP	MAX	
Input Offset Voltage	$V_{OS}$	MAX478ACP/CP		50	170		65	250	μV
		MAX479ACP/CP		60	200		70	290	
		MAX478CS					120	300	
		MAX479CS					130	400	
Input Offset Voltage Drift	$\frac{\Delta V_{OS}}{\Delta T}$	MAX47_ACP/CP (Note 1)		0.5	2.2		0.6	3.0	μV/°C
		MAX47_CS (Note 1)					0.8	4.5	
Input Offset Current	$I_{OS}$			0.06	0.35		0.06	0.50	nA
Input Bias Current	$I_B$			3	6		3	7	nA
Common-Mode Rejection Ratio	CMRR	$V_{CM} = 0V$ to 3.4V		90	101		86	100	dB
Power-Supply Rejection Ratio	PSRR	$V_S = 2.5V$ to 12V		90	102		88	102	dB
Large-Signal Voltage Gain	$A_{VOL}$	$V_O = 0.05V$ to 4V, no load (Note 1)		105	500		80	500	V/mV
		$V_O = 0.05V$ to 3.5V, $R_L = 50k\Omega$		55	160		45	160	
Output Voltage Swing	$V_{OUT}$	Output low, no load		8	11		8	11	mV
		Output low, $I_{SINK} = 100\mu A$		140	190		140	190	
		Output high, no load		4.1	4.3		4.1	4.3	V
		Output high, 2kΩ to GND		3.3	3.8		3.3	3.8	
Supply Current per Amplifier	$I_S$			14	21		15	24	μA

# 17 $\mu$ A Max, Dual/Quad, Single-Supply, Precision Op Amps

## ELECTRICAL CHARACTERISTICS: 5V

( $V_S = 5V$ ,  $0V$ ,  $V_{CM} = 0.1V$ ,  $V_O = 1.4V$ ,  $T_A = -40^\circ C$  to  $+85^\circ C$ , unless otherwise noted.)

PARAMETER	SYMBOL	CONDITIONS	MAX478EP MAX479EP			MAX478ES MAX479ES			UNITS
			MIN	TYP	MAX	MIN	TYP	MAX	
Input Offset Voltage	$V_{OS}$	MAX478	80	315		150	400	$\mu V$	
		MAX479	80	345		160	530		
Input Offset Voltage Drift	$\frac{\Delta V_{OS}}{\Delta T}$	(Note 1)	0.6	3.0		0.8	4.5	$\mu V/^\circ C$	
Input Offset Current	$I_{OS}$		0.07	0.7		0.07	0.7	nA	
Input Bias Current	$I_B$		4	8		4	8	nA	
Common-Mode Rejection Ratio	CMRR	$V_{CM} = 0.05V$ to $3.2V$	84	98		84	98	dB	
Power-Supply Rejection Ratio	PSRR	$V_S = 3.0V$ to $12V$	86	100		86	100	dB	
Large-Signal Voltage Gain	$A_{VOL}$	$V_O = 0.05V$ to $4V$ , no load (Note 1)	55	350		55	350	V/mV	
		$V_O = 0.05V$ to $3.5V$ , $R_L = 50k\Omega$	35	130		35	130		
Output Voltage Swing	$V_{OUT}$	Output low, no load	9	13		9	13	mV	
		Output low, $I_{SINK} = 100\mu A$	160	220		160	220		
		Output high, no load	3.9	4.2		3.9	4.2	V	
		Output high, $2k\Omega$ to GND	3.0	3.7		3.0	3.7		
Supply Current per Amplifier	$I_S$		15	27		15	27	$\mu A$	

# 17 $\mu$ A Max, Dual/Quad, Single-Supply, Precision Op Amps

MAX478/MAX479

## ELECTRICAL CHARACTERISTICS: 3V

( $V_S = 3V$ ,  $0V$ ,  $V_{CM} = 0.1V$ ,  $V_O = 0.8V$ ,  $T_A = +25^\circ C$ , unless otherwise noted.)

PARAMETER	SYMBOL	CONDITIONS	MAX478AC MAX479AC			MAX478C/E MAX479C/E			UNITS
			MIN	TYP	MAX	MIN	TYP	MAX	
Input Offset Voltage	$V_{OS}$	MAX478ACP/CP/EP	30	90		40	140	$\mu V$	
		MAX479ACP/CP/EP	35	120		40	170		
		MAX478CS/ES				80	200		
		MAX479CS/ES				90	270		
Input Offset Current	$I_{OS}$		0.05		0.05		nA		
Input Bias Current	$I_B$		3		3		nA		
Input Noise Voltage	$e_N$	0.1Hz to 10Hz		1.0		1.0	$\mu V_{p-p}$		
Input Voltage Range	$V_{IN(CM)}$	Upper limit	1.7	1.9		1.7	1.9	V	
		Lower limit	0	-0.3		0	-0.3		
Common-Mode Rejection Ratio	CMRR	$V_{CM} = 0V$ to 1.7V	93	103		90	102	dB	
Power-Supply Rejection Ratio	PSRR	$V_S = 2.2V$ to 12V	94	104		92	104	dB	
Large-Signal Voltage Gain	$A_{VOL}$	$V_O = 0.03V$ to 2V, no load (Note 1)	100	600		100	600	V/mV	
		$V_O = 0.03V$ to 1.5V, $R_L = 50k\Omega$	30	180		30	180		
Output Voltage Swing	$V_{OUT}$	Output low, no load		6	9		6	9	mV
		Output low, 2k $\Omega$ to GND		0.2	0.6		0.2	0.6	
		Output high, no load		2.2	2.4		2.2	2.4	V
		Output high, 2k $\Omega$ to GND		1.8	2.0		1.8	2.0	
Gain-Bandwidth Product	GBW	$f_O \leq 5kHz$		50		50		kHz	
Supply Current per Amplifier	$I_S$		12	17		13	20	$\mu A$	
Minimum Supply Voltage	$V_S$			2.2		2.2		V	
		With 300 $\mu V$ $V_{OS}$ degradation	1.7			1.7			

# 17 $\mu$ A Max, Dual/Quad, Single-Supply, Precision Op Amps

## ELECTRICAL CHARACTERISTICS: $\pm 15$ V

( $V_S = \pm 15$ V,  $T_A = +25^\circ\text{C}$ , unless otherwise noted.)

PARAMETER	SYMBOL	CONDITIONS	MAX478AC MAX479AC			MAX478C/E MAX479C/E			UNITS
			MIN	TYP	MAX	MIN	TYP	MAX	
Input Offset Voltage	$V_{OS}$		80	350		100	480	$\mu\text{V}$	
Input Offset Current	$I_{OS}$		0.05	0.25		0.05	0.35	nA	
Input Bias Current	$I_B$		3	5		3	6	nA	
Input Voltage Range	$V_{IN(CM)}$	Upper limit	13.5	13.9		13.5	13.9	V	
		Lower limit	-15.0	-15.3		-15.0	-15.3		
Common-Mode Rejection Ratio	CMRR	$V_{CM} = +13.5\text{V}, -15\text{V}$	97	106		94	106	dB	
Power-Supply Rejection Ratio	PSRR	$V_S = 5\text{V}, 0\text{V to } \pm 15\text{V}$	96	112		94	112	dB	
Large-Signal Voltage Gain	$A_{VOL}$	$V_O = \pm 10\text{V}, R_L = 50\text{k}\Omega$	300	1200		250	1000	V/mV	
		$V_O = \pm 10\text{V}, \text{no load}$	600	2500		400	2500		
Output Voltage Swing	$V_{OUT}$	$R_L = 50\text{k}\Omega$	$\pm 13.0$	$\pm 14.2$		$\pm 13.0$	$\pm 14.2$	V	
		$R_L = 2\text{k}\Omega$	$\pm 11.0$	$\pm 12.7$		$\pm 11.0$	$\pm 12.7$		
Slew Rate	SR	$A_V = +1\text{V}, C_L = 15\text{pF}$	0.02	0.04		0.02	0.04	V/ $\mu\text{s}$	
Gain-Bandwidth Product	GBW	$f_O \leq 5\text{kHz}$		85			85	kHz	
Supply Current per Amplifier	$I_S$		16	21		17	25	$\mu\text{A}$	

# 17μA Max, Dual/Quad, Single-Supply, Precision Op Amps

MAX478/MAX479

## ELECTRICAL CHARACTERISTICS: ±15V

(V<sub>S</sub> = ±15V, T<sub>A</sub> = 0°C to +70°C, unless otherwise noted.)

PARAMETER	SYMBOL	CONDITIONS	MAX478AC MAX479AC		MAX478C MAX479C		UNITS
			MIN	TYP	MAX	MIN	
Input Offset Voltage	V <sub>OS</sub>		100	480	130	660	μV
Input Offset-Voltage Drift	$\frac{\Delta V_{OS}}{\Delta T}$	MAX47_ACP/CP (Note 1)	0.6	2.8	0.7	4.0	μV/°C
		MAX47_CS (Note 1)			0.9	5.5	
Input Offset Current	I <sub>OS</sub>		0.06	0.35	0.06	0.35	nA
Input Bias Current	I <sub>B</sub>		3	6	3	7	nA
Large-Signal Voltage Gain	A <sub>VOL</sub>	V <sub>O</sub> = ±10V, R <sub>L</sub> = 50kΩ	200	800	150	750	V/mV
Common-Mode Rejection Ratio	CMRR	V <sub>CM</sub> = +13V, -15V	94	104	91	104	dB
Power-Supply Rejection Ratio	PSRR	V <sub>S</sub> = 5V, 0V to ±15V	93	110	91	110	dB
Output Voltage Swing	V <sub>OUT</sub>	R <sub>L</sub> = 5kΩ	±11.0	±13.5	±11.0	±13.5	V
Supply Current per Amplifier	I <sub>S</sub>		17	24	18	28	μA

# 17 $\mu$ A Max, Dual/Quad, Single-Supply, Precision Op Amps

## ELECTRICAL CHARACTERISTICS: $\pm 15V$

( $V_S = \pm 15V$ ,  $T_A = -40^\circ C$  to  $+85^\circ C$ , unless otherwise noted.)

PARAMETER	SYMBOL	CONDITIONS	MAX478EP MAX479EP			MAX478ES MAX479ES			UNITS
			MIN	TYP	MAX	MIN	TYP	MAX	
Input Offset Voltage	$V_{OS}$			130	740		130	740	$\mu V$
Input Offset-Voltage Drift	$\frac{\Delta V_{OS}}{\Delta T}$	(Note 1)		0.7	4.0		0.9	5.5	$\mu V/^\circ C$
Input Offset Current	$I_{OS}$			0.07	0.70		0.07	0.70	nA
Input Bias Current	$I_B$			4	8		4	8	nA
Large-Signal Voltage Gain	$A_{VOL}$	$V_O = \pm 10V$ , $R_L = 50k\Omega$	100	500		100	500		V/mV
Common-Mode Rejection Ratio	CMRR	$V_{CM} = +13V$ , $-14.9V$	88	103		88	103		dB
Power-Supply Rejection Ratio	PSRR	$V_S = 5V$ , $0V$ to $\pm 15V$	88	109		88	109		dB
Output Voltage Swing	$V_{OUT}$	$R_L = 5k\Omega$	$\pm 11.0$	$\pm 13.5$		$\pm 11.0$	$\pm 13.5$		V
Supply Current per Amplifier	$I_S$			19	30		19	30	$\mu A$

**Note 1:** Guaranteed by design.

**Note 2:** Power-supply rejection ratio is measured at the minimum supply voltage. The op amps actually work at 1.7V supply, but with additional input offset-voltage skew.

# 17 $\mu$ A Max, Dual/Quad, Single-Supply, Precision Op Amps

## Typical Operating Characteristics

MAX478/MAX479

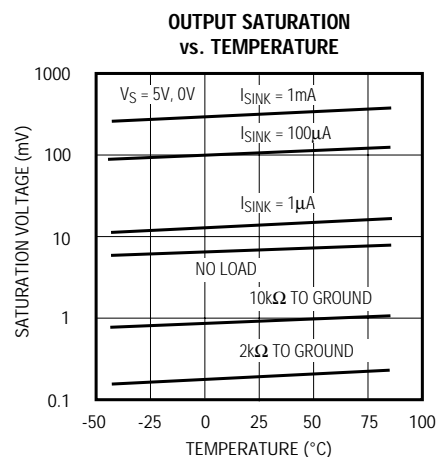
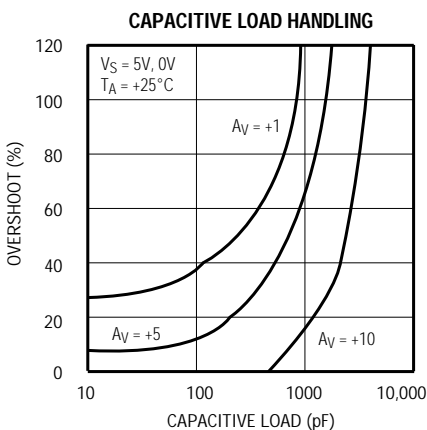
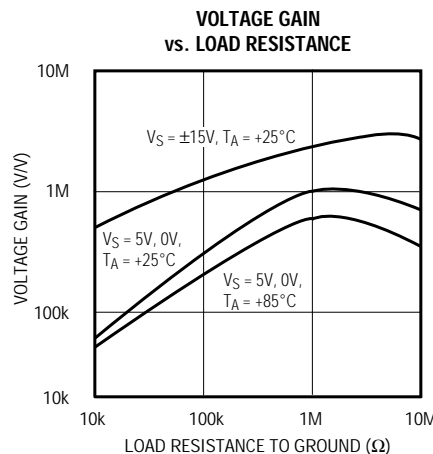
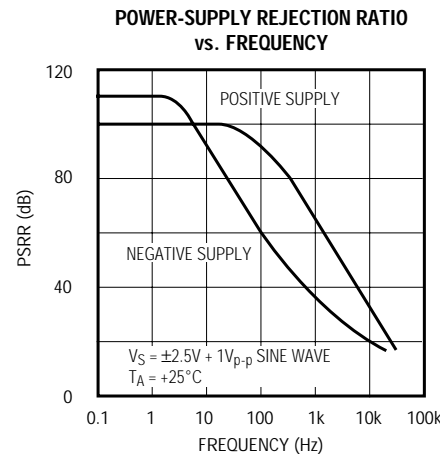
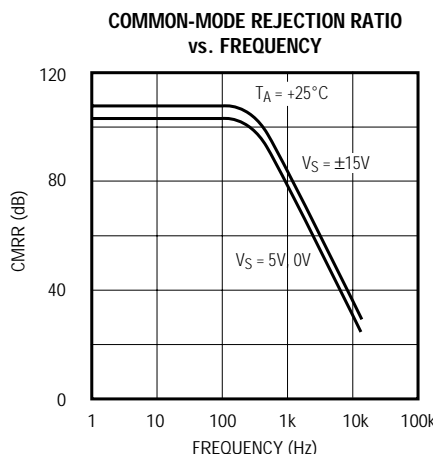
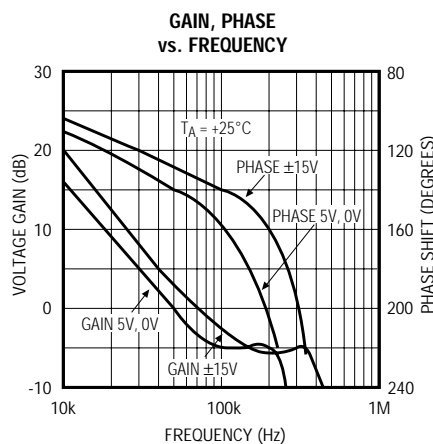
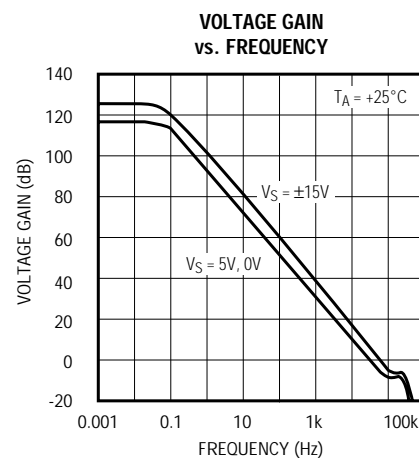
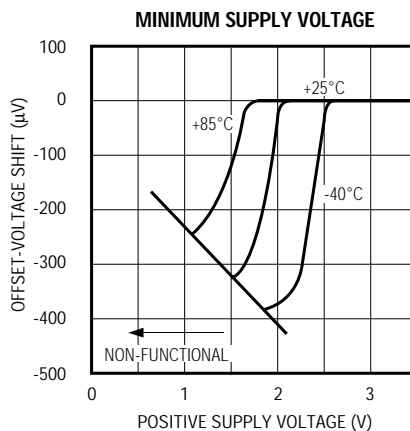
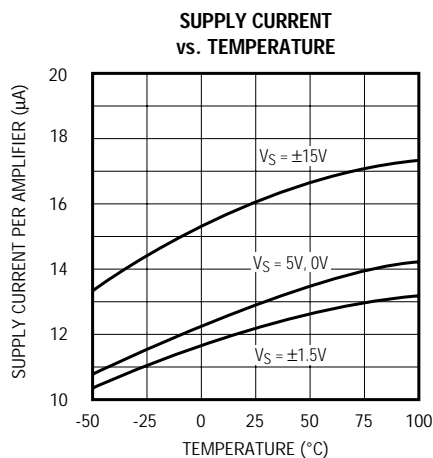

# 17 $\mu$ A Max, Dual/Quad, Single-Supply, Precision Op Amps

Typical Operating Characteristics (continued)

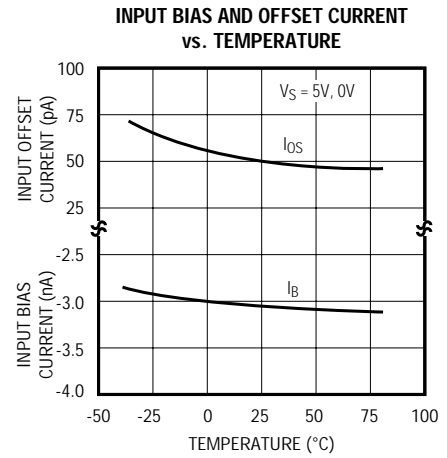
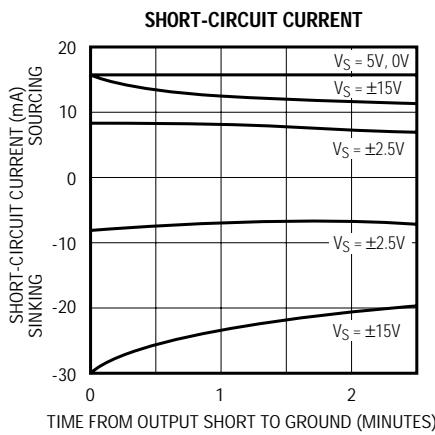
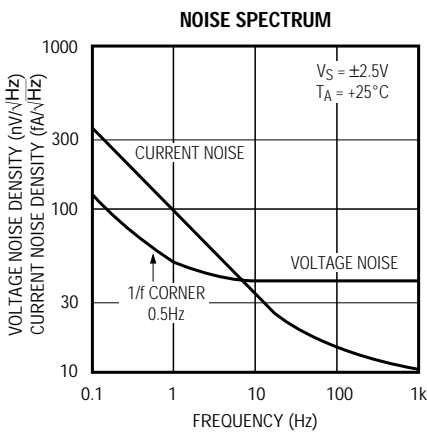

**LARGE-SIGNAL TRANSIENT RESPONSE**  
 $V_S = \pm 15V$

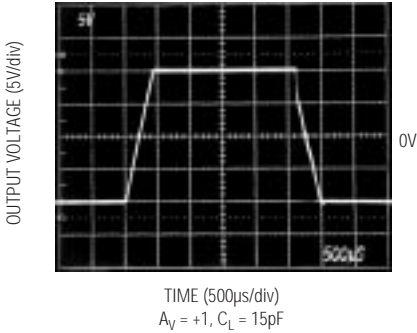

**LARGE-SIGNAL TRANSIENT RESPONSE**  
 $V_S = 5V, 0V$

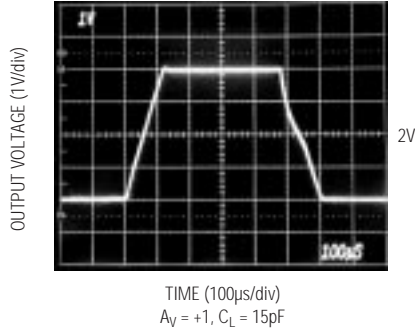

**SMALL-SIGNAL TRANSIENT RESPONSE**  
 $V_S = \pm 2.5V$

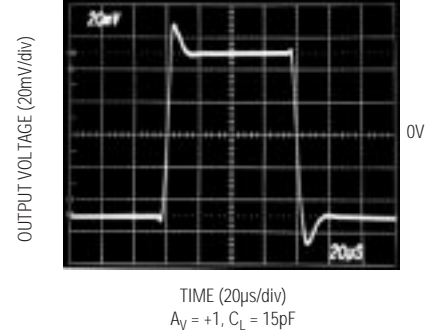

**SMALL-SIGNAL TRANSIENT RESPONSE**  
 $V_S = 5V, 0V$

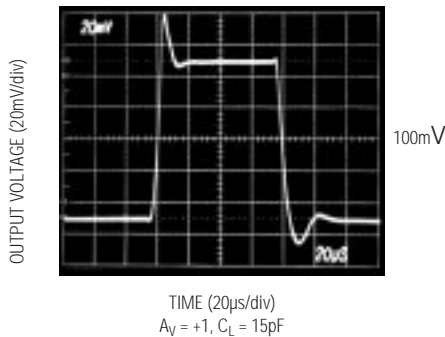

**SMALL-SIGNAL TRANSIENT RESPONSE**  
 $V_S = \pm 15V$

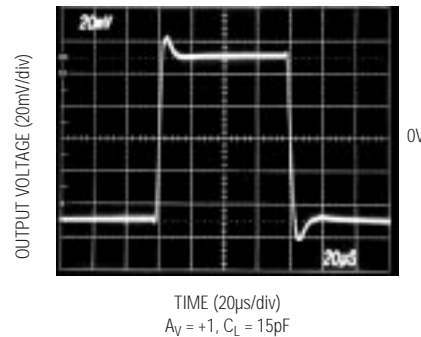

# 17µA Max, Dual/Quad, Single-Supply, Precision Op Amps

MAX478/MAX479

Typical Application Circuit

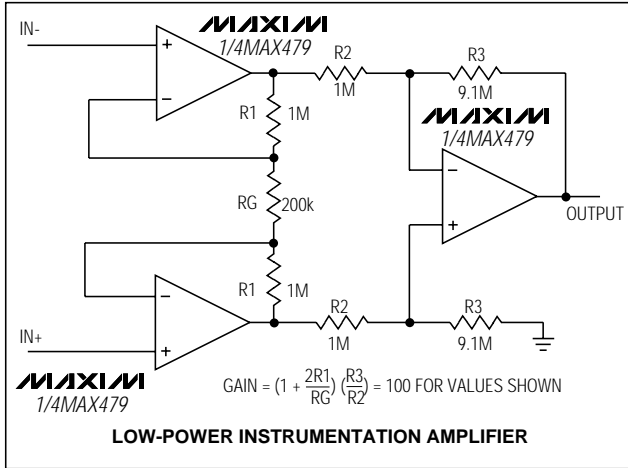

Chip Topography

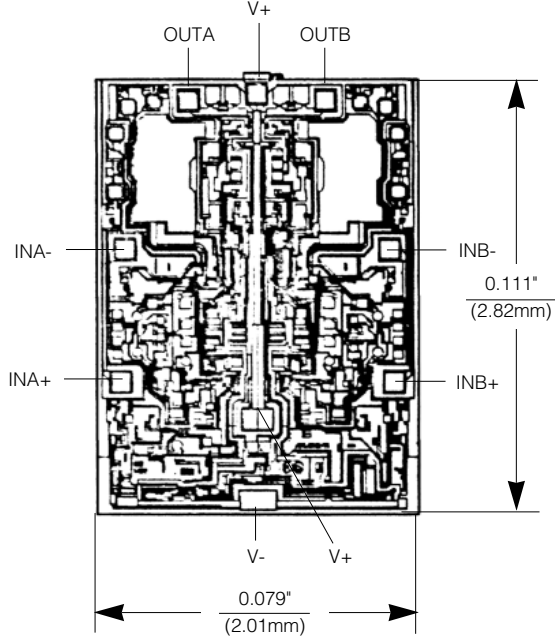

Package Information

	INCHES		MILLIMETERS	
	MIN	MAX	MIN	MAX
A	0.053	0.069	1.35	1.75
A1	0.004	0.010	0.10	0.25
B	0.014	0.019	0.35	0.49
C	0.007	0.010	0.19	0.25
e	0.050		1.27	
E	0.150	0.157	3.80	4.00
H	0.228	0.244	5.80	6.20
h	0.010	0.020	0.25	0.50
L	0.016	0.050	0.40	1.27

	INCHES		MILLIMETERS		N	MS012
	MIN	MAX	MIN	MAX		
D	0.189	0.197	4.80	5.00	8	A
D	0.337	0.344	8.55	8.75	14	B
D	0.386	0.394	9.80	10.00	16	C

NOTES:  
 1. D&E DO NOT INCLUDE MOLD FLASH  
 2. MOLD FLASH OR PROTRUSIONS NOT TO EXCEED .15mm (.006")  
 3. LEADS TO BE COPLANAR WITHIN .102mm (.004")  
 4. CONTROLLING DIMENSION: MILLIMETER  
 5. MEETS JEDEC MS012-XX AS SHOWN IN ABOVE TABLE  
 6. N = NUMBER OF PINS

**MAXIM** PACKAGE FAMILY OUTLINE: SOIC .150" 1/1 21-0041 A

# 17µA Max, Dual/Quad, Single-Supply, Precision Op Amps

Package Information (continued)

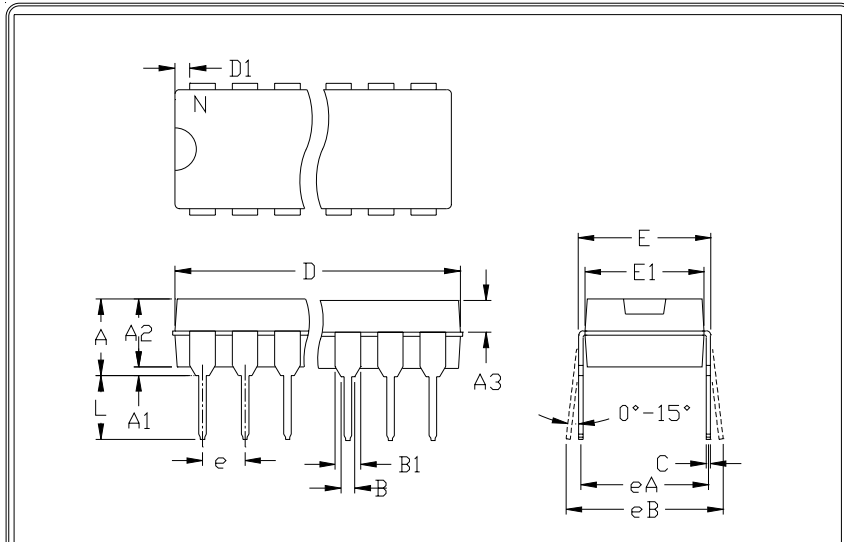

	INCHES		MILLIMETERS	
	MIN	MAX	MIN	MAX
A	---	0.200	---	5.08
A1	0.015	---	0.38	---
A2	0.125	0.175	3.18	4.45
A3	0.055	0.080	1.40	2.03
B	0.016	0.022	0.41	0.56
B1	0.045	0.065	1.14	1.65
C	0.008	0.012	0.20	0.30
D1	0.005	0.080	0.13	2.03
E	0.300	0.325	7.62	8.26
E1	0.240	0.310	6.10	7.87
e	0.100	---	2.54	---
eA	0.300	---	7.62	---
eB	---	0.400	---	10.16
L	0.115	0.150	2.92	3.81

	INCHES		MILLIMETERS		N	MS001
	MIN	MAX	MIN	MAX		
D	0.348	0.390	8.84	9.91	8	AB
D	0.735	0.765	18.67	19.43	14	AC
D	0.745	0.765	18.92	19.43	16	AA
D	0.885	0.915	22.48	23.24	18	AD
D	1.015	1.045	25.78	26.54	20	AE
D	1.14	1.265	28.96	32.13	24	AF
D	1.360	1.380	34.54	35.05	28	*5

- NOTES:  
 1. D&E DO NOT INCLUDE MOLD FLASH  
 2. MOLD FLASH OR PROTRUSIONS NOT TO EXCEED .15mm (.006")  
 3. CONTROLLING DIMENSION: MILLIMETER  
 4. MEETS JEDEC MS001-XX AS SHOWN IN ABOVE TABLE  
 5. SIMILAR TO JEDEC MO-058AB  
 6. N = NUMBER OF PINS

**MAXIM** PACKAGE FAMILY OUTLINE: PDIP .300"  $\frac{1}{1}$  21-0043 A  
120 SAN GABRIEL DR. SUNNYVALE, CA 94086 FAX (408) 737-7794 PROPRIETARY INFORMATION TITLE DOCUMENT CONTROL NUMBER REV

Maxim cannot assume responsibility for use of any circuitry other than circuitry entirely embodied in a Maxim product. No circuitry patent licenses are implied. Maxim reserves the right to change the circuitry and specifications without notice at any time.

12 Maxim Integrated Products, 120 San Gabriel Drive, Sunnyvale, CA 94086 408-737-7600

## Looking for pricing, stock, or lifecycle information?

Click below to explore more details on WIN SOURCE:

- ⊖ [View MAX479CPD on WIN SOURCE](#)
- ⊖ [Maxim Integrated Information](#)

## Optimize Your Supply Chain with WIN SOURCE Solutions

- ✓ Global Sourcing Solution
- ✓ Obsolete Management
- ✓ Cost Control Management
- ✓ Shortage Management
- ✓ Alternative Solution
- ✓ Excess Inventory Management