

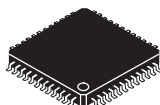

**THE DATASHEET OF
ADS8383IBPFBT**





18-BIT, 500-kHz, UNIPOLAR INPUT, MICROPOWER SAMPLING ANALOG-TO-DIGITAL CONVERTER WITH PARALLEL INTERFACE

FEATURES

- 500-kHz Sample Rate
- 18-Bit NMC Ensured Over Temperature
- Zero Latency
- Low Power: 110 mW at 500 kHz
- Unipolar Input Range
- Onboard Reference Buffer
- High-Speed Parallel Interface
- Wide Digital Supply
- 8-/16-/18-Bit Bus Transfer
- 48-Pin TQFP Package

APPLICATIONS

- Medical Instruments
- Optical Networking
- Transducer Interface
- High Accuracy Data Acquisition Systems
- Magnetometers

DESCRIPTION

The ADS8383 is an 18-bit, 500 kHz A/D converter. The device includes a 18-bit capacitor-based SAR A/D converter with inherent sample and hold. The ADS8383 offers a full 18-bit interface, a 16-bit option where data is read using two read cycles or an 8-bit bus option using three read cycles.

The ADS8383 is available in a 48-lead TQFP package and is characterized over the industrial -40°C to 85°C temperature range.

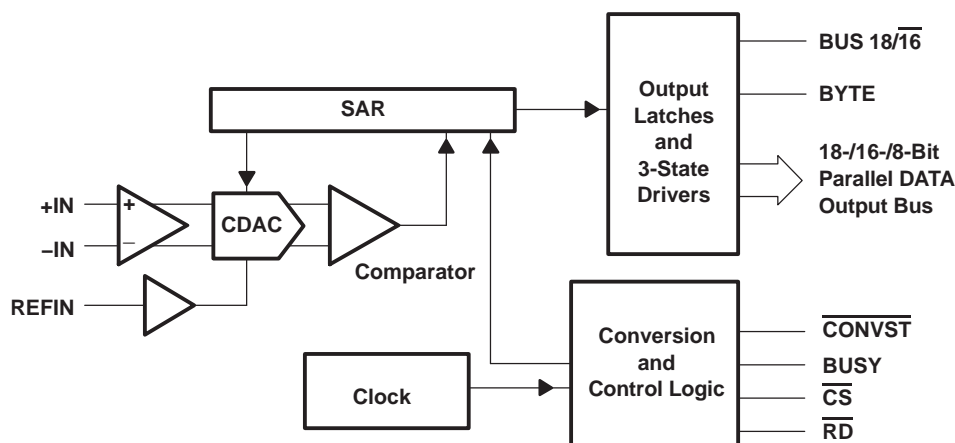

Please be aware that an important notice concerning availability, standard warranty, and use in critical applications of Texas Instruments semiconductor products and disclaimers thereto appears at the end of this data sheet.



These devices have limited built-in ESD protection. The leads should be shorted together or the device placed in conductive foam during storage or handling to prevent electrostatic damage to the MOS gates.

ORDERING INFORMATION

MODEL	MAXIMUM INTEGRAL LINEARITY (LSB)	MAXIMUM DIFFERENTIAL LINEARITY (LSB)	NO MISSING CODES RESOLUTION (BIT)	PACKAGE TYPE	PACKAGE DESIGNATOR	TEMPERATURE RANGE	ORDERING INFORMATION	TRANSPORT MEDIA QUANTITY
ADS8383I	±10	-2~7	17	48 Pin TQFP	PFB	-40°C to 85°C	ADS8383IPFBT	Tape and reel 250
							ADS8383IPFBR	Tape and reel 1000
ADS8383IB	±7	-1~2.5	18	48 Pin TQFP	PFB	-40°C to 85°C	ADS8383IBPFBT	Tape and reel 250
							ADS8383IBPFBR	Tape and reel 1000

NOTE: For the most current package and ordering information, see the Package Option Addendum at the end of this document, or see the TI website at www.ti.com.

ABSOLUTE MAXIMUM RATINGS

over operating free-air temperature range unless otherwise noted⁽¹⁾

		UNIT
Voltage	+IN to AGND	-0.4 V to +VA + 0.1 V
	-IN to AGND	-0.4 V to 0.5 V
Voltage	+VA to AGND	-0.3 V to 7 V
	+VBD to BDGND	-0.3 V to 7 V
	+VA to +VBD	-0.3 V to 2.5 V
Digital input voltage to BDGND		-0.3 V to +VBD + 0.3 V
Digital output voltage to BDGND		-0.3 V to +VBD + 0.3 V
Operating free-air temperature range, T _A		-40°C to 85°C
Storage temperature range, T _{stg}		-65°C to 150°C
Junction temperature (T _J max)		150°C
TQFP package	Power dissipation	(T _J Max - T _A)/θ _{JA}
	θ _{JA} thermal impedance	86°C/W
Lead temperature, soldering	Vapor phase (60 sec)	215°C
	Infrared (15 sec)	220°C

⁽¹⁾ Stresses beyond those listed under “absolute maximum ratings” may cause permanent damage to the device. These are stress ratings only, and functional operation of the device at these or any other conditions beyond those indicated under “recommended operating conditions” is not implied. Exposure to absolute-maximum-rated conditions for extended periods may affect device reliability.

SPECIFICATIONS
 $T_A = -40^{\circ}\text{C}$ to 85°C , $+V_A = 5\text{ V}$, $+V_{BD} = 3\text{ V}$ or 5 V , $V_{\text{ref}} = 4.096\text{ V}$, $f_{\text{SAMPLE}} = 500\text{ kHz}$ (unless otherwise noted)

PARAMETER		TEST CONDITIONS	MIN	TYP	MAX	UNIT
Analog Input						
Full-scale input voltage (see Note 1)		+IN – –IN	0		V_{ref}	V
Absolute input voltage		+IN	–0.2		$V_{\text{ref}} + 0.2$	V
		–IN	–0.2		0.2	
Input capacitance				45		pF
Input leakage current				1		nA
System Performance						
Resolution				18		Bits
No missing codes	ADS8383I	(+IN – –IN) < 0.5 FS	17			Bits
		(+IN – –IN) \geq 0.5 FS	17			
	ADS8383IB		18			
Integral linearity (see Notes 2 and 3)	ADS8383I	(+IN – –IN) < 0.125 FS	–4		4	LSB (18 bit)
		(+IN – –IN) < 0.5 FS	–6		6	
		(+IN – –IN) \geq 0.5 FS	–10		10	
	ADS8383IB		–7	–2/3	7	
Differential linearity	ADS8383I	(+IN – –IN) < 0.125 FS	–1		2	LSB (18 bit)
		(+IN – –IN) < 0.5 FS	–1		3	
		(+IN – –IN) \geq 0.5 FS	–2		7	
	ADS8383IB		–1	–1/1.4	2.5	
Offset error (see Note 4)	ADS8383I		–1	± 0.5	1	mV
	ADS8383IB		–0.75	± 0.25	0.75	
Gain error (see Note 4)	ADS8383I	$V_{\text{ref}} = 4.096\text{ V}$	–0.1		0.1	%FS
	ADS8383IB	$V_{\text{ref}} = 4.096\text{ V}$	–0.06		0.06	%FS
Noise				60		$\mu\text{V RMS}$
Power supply rejection ratio		At 3FFFFh output code		75		dB
Sampling Dynamics						
Conversion time					1.52	μs
Acquisition time			0.4			μs
Throughput rate					500	kHz
Aperture delay				4		ns
Aperture jitter				15		ps
Step response				150		ns
Over voltage recovery				150		ns

(1) Ideal input span, does not include gain or offset error.

(2) LSB means least significant bit

(3) This is endpoint INL, not best fit.

(4) Measured relative to an ideal full-scale input (+IN – –IN) of 4.096 V

SPECIFICATIONS (CONTINUED)

T_A = -40°C to 85°C, +V_A = +5 V, +V_{BD} = 3 V or 5 V, V_{ref} = 4.096 V, f_{SAMPLE} = 500 kHz (unless otherwise noted)

PARAMETER		TEST CONDITIONS	MIN	TYP	MAX	UNIT
Dynamic Characteristics						
Total harmonic distortion (THD) (see Note 1)	ADS8383I	V _{IN} = 4 V _{pp} at 1 kHz		-110		dB
	ADS8383IB			-112		
	ADS8383I	V _{IN} = 4 V _{pp} at 10 kHz		-98		
	ADS8383IB			-108		
	ADS8383I	V _{IN} = 4 V _{pp} at 50 kHz		-98		
	ADS8383IB			-99		
	ADS8383I	V _{IN} = 4 V _{pp} at 100 kHz		-90		
	ADS8383IB			-91		
Signal to noise ratio (SNR) (see Note 1)	ADS8383I	V _{IN} = 4 V _{pp} at 1 kHz		87		dB
	ADS8383IB			88		
	ADS8383I	V _{IN} = 4 V _{pp} at 10 kHz		87		
	ADS8383IB			87		
	ADS8383I	V _{IN} = 4 V _{pp} at 50 kHz		87		
	ADS8383IB			87		
	ADS8383I	V _{IN} = 4 V _{pp} at 100 kHz		87		
	ADS8383IB			87		
Signal to noise + distortion (SINAD) (see Note 1)	ADS8383I	V _{IN} = 4 V _{pp} at 1 kHz		86		dB
	ADS8383IB			87		
	ADS8383I	V _{IN} = 4 V _{pp} at 10 kHz		86		
	ADS8383IB			86		
	ADS8383I	V _{IN} = 4 V _{pp} at 50 kHz		86		
	ADS8383IB			86		
	ADS8383I	V _{IN} = 4 V _{pp} at 100 kHz		85		
	ADS8383IB			85		
Spurious free dynamic range (SFDR) (see Note 1)	ADS8383I	V _{IN} = 4 V _{pp} at 1 kHz		110		dB
	ADS8383IB			112		
	ADS8383I	V _{IN} = 4 V _{pp} at 10 kHz		98		
	ADS8383IB			108		
	ADS8383I	V _{IN} = 4 V _{pp} at 50 kHz		98		
	ADS8383IB			98		
	ADS8383I	V _{IN} = 4 V _{pp} at 100 kHz		90		
	ADS8383IB			94		
-3dB Small signal bandwidth				3		MHz
Voltage Reference Input						
Reference voltage at REFIN, V _{ref}			2.5	4.096	4.2	V
Reference resistance (see Note 2)				500		kΩ
Reference current drain		f _S = 500 kHz			1	mA
Bias Input						
Bias input range			2	2.048	2.1	V
Bias input drift					±5	%FS
Bias input current, sink			-150	-100		μA

(1) Calculated on the first nine harmonics of the input frequency

(2) Can vary ±20%

SPECIFICATIONS (CONTINUED)
 $T_A = -40^\circ\text{C}$ to 85°C , $+VA = +5\text{ V}$, $+VBD = 3\text{ V}$ or 5 V , $V_{\text{ref}} = 4.096\text{ V}$, $f_{\text{SAMPLE}} = 500\text{ kHz}$ (unless otherwise noted)

PARAMETER		TEST CONDITIONS	MIN	TYP	MAX	UNIT
Digital Input/Output						
Logic family			CMOS			
Logic level	V_{IH}	$I_{IH} = 5\ \mu\text{A}$	$+VBD - 1$	$+VBD + 0.3$		V
	V_{IL}	$I_{IL} = 5\ \mu\text{A}$	-0.3	0.8		
	V_{OH}	$I_{OH} = 2\text{ TTL loads}$	$+VBD - 0.6$			
	V_{OL}	$I_{OL} = 2\text{ TTL loads}$	0.4			
Data format			Straight Binary			
Power Supply Requirements						
Power supply voltage	$+VBD$ (see Notes 1 and 2)		2.95	3.3	5.25	V
	$+VA$ (see Note 2)		4.75	5	5.25	V
Supply current, 500-kHz sample rate (see Note 3)				22	26	mA
Power dissipation, 500-kHz sample rate (see Note 3)				110	130	mW
Temperature Range						
Operating free-air			-40		85	$^\circ\text{C}$

(1) The difference between $+VA$ and $+VBD$ should be no less than 2.3 V, i.e. if $+VA$ is 5.5 V, $+VBD$ should be at least 2.95 V.

(2) $+VBD \geq +VA - 2.3\text{ V}$

(3) This includes only $+VA$ current. $+VBD$ current is typical 1 mA with 5 pF load capacitance on all output pins.

TIMING CHARACTERISTICS

All specifications typical at -40°C to 85°C, +VA = +VBD = 5 V (see Notes 1, 2, and 3)

PARAMETER		MIN	TYP	MAX	UNIT
t _{CONV}	Conversion time			1.52	μs
t _{ACQ}	Acquisition time	0.4			μs
t _{HOLD}	Hold time, sampling capacitor			25	ns
t _{pd1}	Propagation delay time, $\overline{\text{CONVST}}$ low to conversion started (BUSY high)			45	ns
t _{pd2}	Propagation delay time, end of conversion to BUSY low			20	ns
t _{pd3}	Propagation delay time, from start of CONVERT state to rising edge of BUSY			20	ns
t _{w1}	Pulse duration, $\overline{\text{CONVST}}$ low	40			ns
t _{su1}	Setup time, $\overline{\text{CS}}$ low to $\overline{\text{CONVST}}$ low	20			ns
t _{w2}	Pulse duration, $\overline{\text{CONVST}}$ high	20			ns
	$\overline{\text{CONVST}}$ falling edge jitter			10	ps
t _{w3}	Pulse duration, BUSY low	Min(t _{ACQ})			μs
t _{w4}	Pulse duration, BUSY high			1.52	μs
t _{h1}	Hold time, first data bus data transition ($\overline{\text{RD}}$ low, or $\overline{\text{CS}}$ low for read cycle, or BYTE or BUS18/16 input changes) after $\overline{\text{CONVST}}$ low	40			ns
t _{d1}	Delay time, $\overline{\text{CS}}$ low to $\overline{\text{RD}}$ low	0			ns
t _{su2}	Setup time, $\overline{\text{RD}}$ high to $\overline{\text{CS}}$ high	0			ns
t _{w5}	Pulse duration, $\overline{\text{RD}}$ low	50			ns
t _{en}	Enable time, $\overline{\text{RD}}$ low (or $\overline{\text{CS}}$ low for read cycle) to data valid			20	ns
t _{d2}	Delay time, data hold from $\overline{\text{RD}}$ high	5			ns
t _{d3}	Delay time, BUS18/16 or BYTE rising edge or falling edge to data valid	10		20	ns
t _{w6}	Pulse duration, $\overline{\text{RD}}$ high	20			ns
t _{w7}	Pulse duration, $\overline{\text{CS}}$ high	20			ns
t _{h2}	Hold time, last $\overline{\text{RD}}$ (or $\overline{\text{CS}}$ for read cycle) rising edge to $\overline{\text{CONVST}}$ falling edge	125			ns
t _{pd4}	Propagation delay time, BUSY falling edge to next $\overline{\text{RD}}$ (or $\overline{\text{CS}}$ for read cycle) falling edge	Max(t _{d5})			ns
t _{d4}	Delay time, BYTE edge to BUS18/16 edge skew	0			ns
t _{su3}	Setup time, BYTE or BUS18/16 transition to $\overline{\text{RD}}$ falling edge	10			ns
t _{h3}	Hold time, BYTE or BUS18/16 transition to $\overline{\text{RD}}$ falling edge	10			ns
t _{dis}	Disable time, $\overline{\text{RD}}$ High ($\overline{\text{CS}}$ high for read cycle) to 3-stated data bus			20	ns
t _{d5}	Delay time, BUSY low to MSB data valid			30	ns
t _{su5}	Setup time, BYTE transition to next BYTE transition, or BUS18/16 to next BUS18/16	50			ns

(1) All input signals are specified with t_r = t_f = 5 ns (10% to 90% of +VBD) and timed from a voltage level of (V_{IL} + V_{IH})/2.

(2) See timing diagrams.

(3) All timing are measured with 20 pF equivalent loads on all data bits and BUSY pins.

TIMING CHARACTERISTICS

All specifications typical at -40°C to 85°C, +VA = 5 V, +VBD = 3 V (see Notes 1, 2, and 3)

PARAMETER		MIN	TYP	MAX	UNIT
t _{CONV}	Conversion time			1.52	μs
t _{ACQ}	Acquisition time	0.4			μs
t _{HOLD}	Hold time, sampling capacitor			25	ns
t _{pd1}	Propagation delay time, $\overline{\text{CONVST}}$ low to conversion started (BUSY high)			50	ns
t _{pd2}	Propagation delay time, end of conversion to BUSY low			25	ns
t _{pd3}	Propagation delay time, start of CONVERT state to rising edge of BUSY			25	ns
t _{w1}	Pulse duration, $\overline{\text{CONVST}}$ low	40			ns
t _{su1}	Setup time, $\overline{\text{CS}}$ low to $\overline{\text{CONVST}}$ low	20			ns
t _{w2}	Pulse duration, $\overline{\text{CONVST}}$ high	20			ns
	$\overline{\text{CONVST}}$ falling edge jitter			10	ps
t _{w3}	Pulse duration, BUSY low	Min(t _{ACQ})			μs
t _{w4}	Pulse duration, BUSY high			1.52	μs
t _{h1}	Hold time, first data bus transition ($\overline{\text{RD}}$ low, or $\overline{\text{CS}}$ low for read cycle, or BYTE or BUS 18/16 input changes) after $\overline{\text{CONVST}}$ low	40			ns
t _{d1}	Delay time, $\overline{\text{CS}}$ low to $\overline{\text{RD}}$ low	0			ns
t _{su2}	Setup time, $\overline{\text{RD}}$ high to $\overline{\text{CS}}$ high	0			ns
t _{w5}	Pulse duration, $\overline{\text{RD}}$ low	50			ns
t _{en}	Enable time, $\overline{\text{RD}}$ low (or $\overline{\text{CS}}$ low for read cycle) to data valid			30	ns
t _{d2}	Delay time, data hold from $\overline{\text{RD}}$ high	10			ns
t _{d3}	Delay time, BUS18/16 or BYTE rising edge or falling edge to data valid	10		30	ns
t _{w6}	Pulse duration, $\overline{\text{RD}}$ high	20			ns
t _{w7}	Pulse duration, $\overline{\text{CS}}$ high	20			ns
t _{h2}	Hold time, last $\overline{\text{RD}}$ (or $\overline{\text{CS}}$ for read cycle) rising edge to $\overline{\text{CONVST}}$ falling edge	125			ns
t _{pd4}	Propagation delay time, BUSY falling edge to next $\overline{\text{RD}}$ (or $\overline{\text{CS}}$ for read cycle) falling edge	Max(td5)			ns
t _{d4}	Delay time, BYTE edge to BUS18/16 edge skew	0			ns
t _{su3}	Setup time, BYTE or BUS18/16 rising edge to $\overline{\text{RD}}$ falling edge	10			ns
t _{h3}	Hold time, BYTE or BUS18/16 falling edge to $\overline{\text{RD}}$ falling edge	10			ns
t _{dis}	Disable time, $\overline{\text{RD}}$ High ($\overline{\text{CS}}$ high for read cycle) to 3-stated data bus			30	ns
t _{d5}	Delay time, BUSY low to MSB data valid delay time			40	ns
t _{su5}	Setup time, from BYTE transition to next BYTE transition or from BUS18/16 to next BUS18/16	50			ns

(1) All input signals are specified with t_r = t_f = 5 ns (10% to 90% of +VBD) and timed from a voltage level of (V_{IL} + V_{IH})/2.

(2) See timing diagrams.

(3) All timing are measured with 10 pF equivalent loads on all data bits and BUSY pins.

PIN ASSIGNMENTS

PFB PACKAGE
(TOP VIEW)

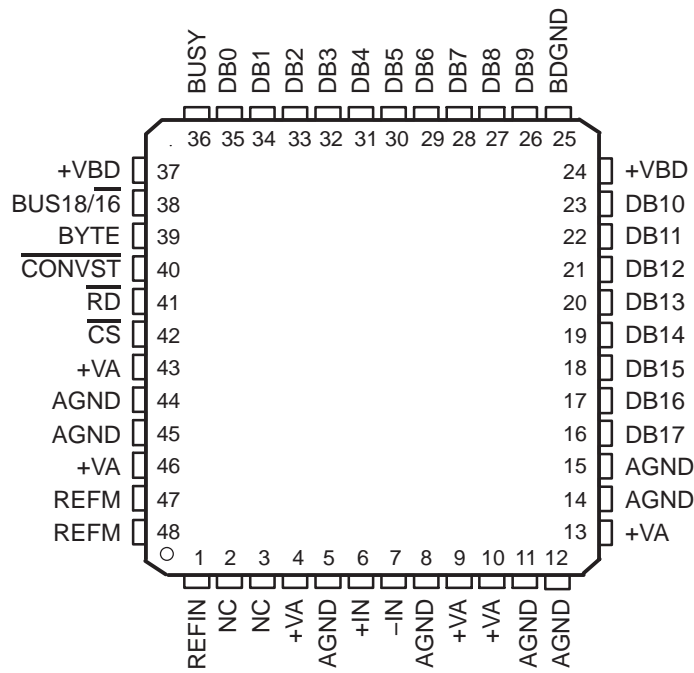

NC – No connection.

TERMINAL FUNCTIONS

NAME	NO.	I/O	DESCRIPTION					
AGND	5, 8, 11, 12, 14, 15, 44, 45	–	Analog ground					
BDGND	25	–	Digital ground for bus interface digital supply					
BUSY	36	O	Status output. High when a conversion is in progress.					
BUS18/16	38	I	Bus size select input. Used for selecting 18-bit or 16-bit wide bus transfer. 0: Data bits output on the 18-bit data bus pins DB[17:0]. 1: Last two data bits D[1:0] from 18-bit wide bus output on: a) the low byte pins DB[9:2] if BYTE = 0 b) the high byte pins DB[17:10] if BYTE = 1					
BYTE	39	I	Byte select input. Used for 8-bit bus reading. 0: No fold back 1: Low byte D[9:2] of the 16 most significant bits is folded back to high byte of the 16 most significant pins DB[17:10].					
CONVST	40	I	Convert start. The falling edge of this input ends the acquisition period and starts the hold period.					
CS	42	I	Chip select. The falling edge of this input starts the acquisition period					
Data Bus			8-Bit Bus			16-Bit Bus		18-Bit Bus
			BYTE = 0	BYTE = 1	BYTE = 1	BYTE = 0	BYTE = 0	BYTE = 0
			BUS18/16 = 0	BUS18/16 = 0	BUS18/16 = 1	BUS18/16 = 0	BUS18/16 = 1	BUS18/16 = 0
DB17	16	O	D17 (MSB)	D9	All ones	D17 (MSB)	All ones	D17 (MSB)
DB16	17	O	D16	D8	All ones	D16	All ones	D16
DB15	18	O	D15	D7	All ones	D15	All ones	D15
DB14	19	O	D14	D6	All ones	D14	All ones	D14
DB13	20	O	D13	D5	All ones	D13	All ones	D13
DB12	21	O	D12	D4	All ones	D12	All ones	D12
DB11	22	O	D11	D3	D1	D11	All ones	D11
DB10	23	O	D10	D2	D0(LSB)	D10	All ones	D10
DB9	26	O	D9	All ones	All ones	D9	All ones	D9
DB8	27	O	D8	All ones	All ones	D8	All ones	D8
DB7	28	O	D7	All ones	All ones	D7	All ones	D7
DB6	29	O	D6	All ones	All ones	D6	All ones	D6
DB5	30	O	D5	All ones	All ones	D5	All ones	D5
DB4	31	O	D4	All ones	All ones	D4	All ones	D4
DB3	32	O	D3	All ones	All ones	D3	D1	D3
DB2	33	O	D2	All ones	All ones	D2	D0 (LSB)	D2
DB1	34	O	D1	All ones	All ones	D1	All ones	D1
DB0	35	O	D0 (LSB)	All ones	All ones	D0 (LSB)	All ones	D0 (LSB)
–IN	7	I	Inverting input channel					
+IN	6	I	Noninverting input channel					
NC	2, 3	–	No connection					
REFIN	1	I	Reference input.					
REFM	47, 48	I	Reference ground.					
RD	41	I	Synchronization pulse for the parallel output. When CS is low this serves as output enable.					
+VA	4, 9, 10, 13, 43, 46	–	Analog power supplies, 5-V dc					
+VBD	24, 37	–	Digital power supply for bus					

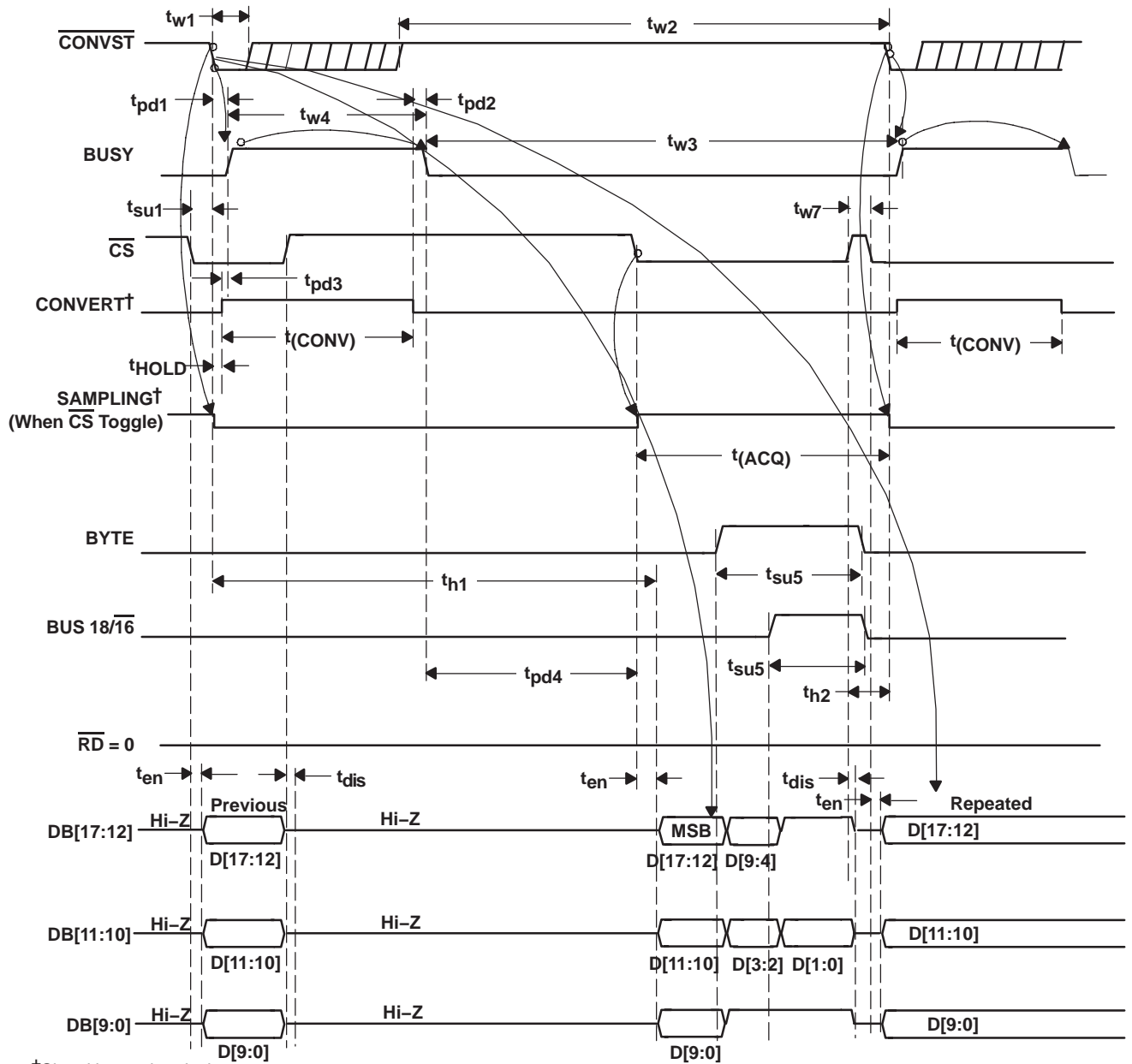

†Signal internal to device

NOTE: $\overline{\text{RD}}$ cannot be tied to BDGND. Three read cycles are required at power on.

Figure 2. Timing for Conversion and Acquisition Cycles With $\overline{\text{CS}}$ Toggling, $\overline{\text{RD}}$ Held at BDGND After Power-On Initialization

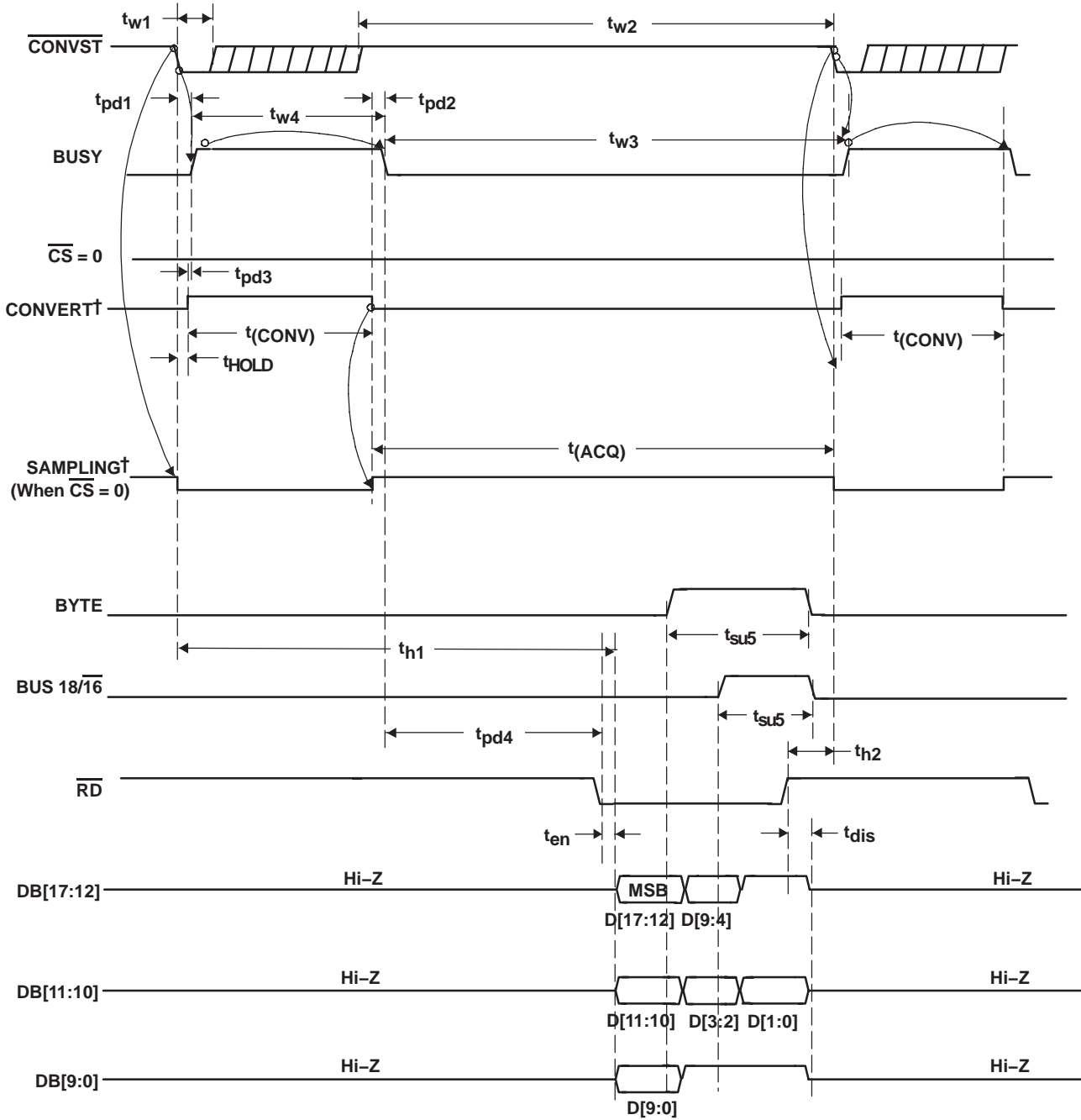

† Signal internal to device

Figure 3. Timing for Conversion and Acquisition Cycles With $\overline{\text{CS}}$ Tied to BDGND , $\overline{\text{RD}}$ Toggling

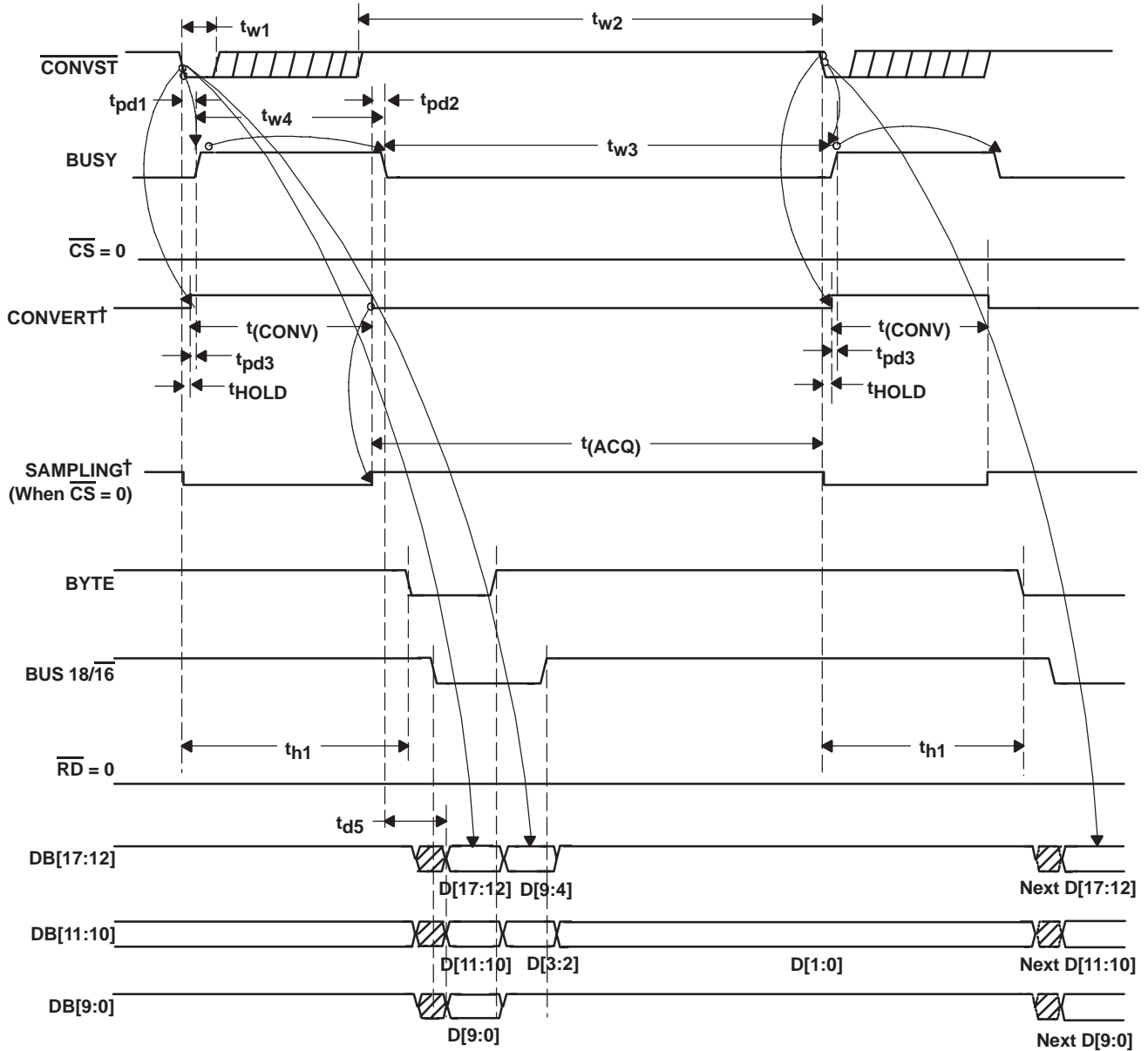

[†]Signal internal to device

NOTE: $\overline{\text{RD}}$ cannot be tied to BDGND. Three read cycles are required at power on.

Figure 4. Timing for Conversion and Acquisition Cycles With $\overline{\text{CS}}$ and $\overline{\text{RD}}$ Held at BDGND After Power-On Initialization - Auto Read

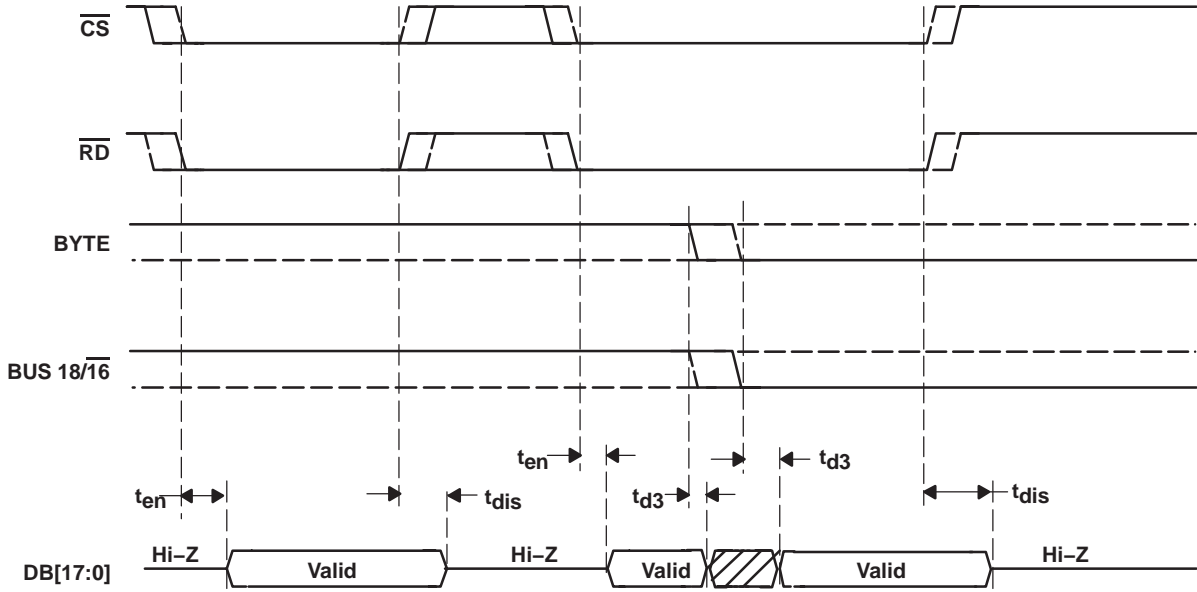

Figure 5. Detailed Timing for Read Cycles

TYPICAL CHARACTERISTICS†

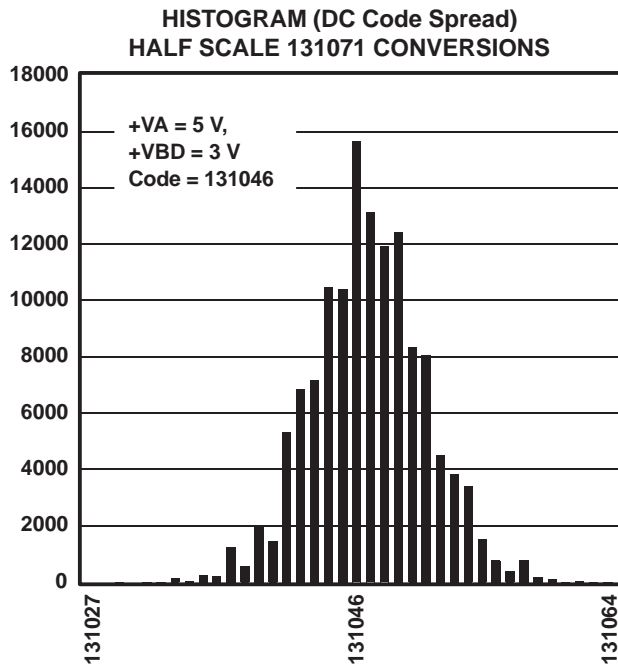

Figure 6

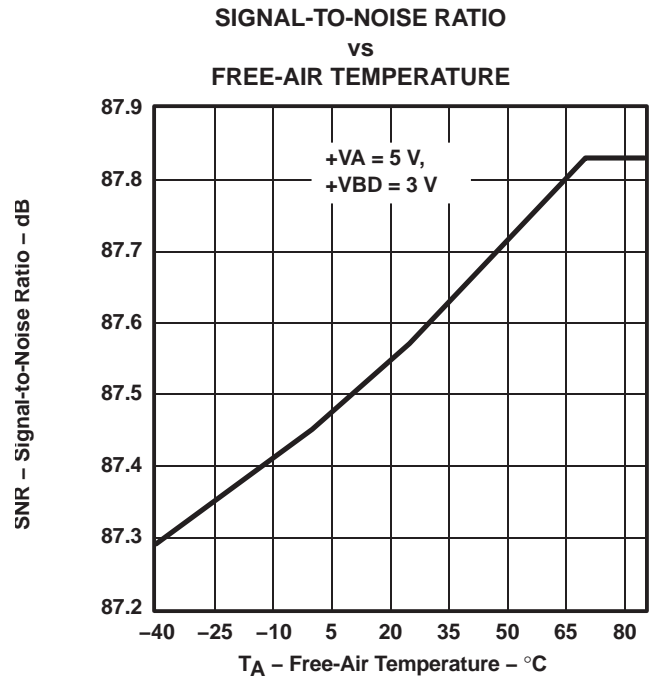

Figure 7

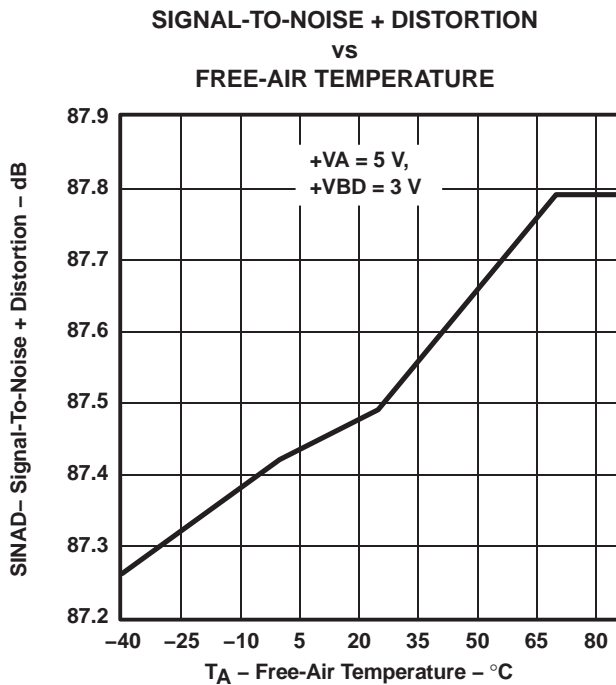

Figure 8

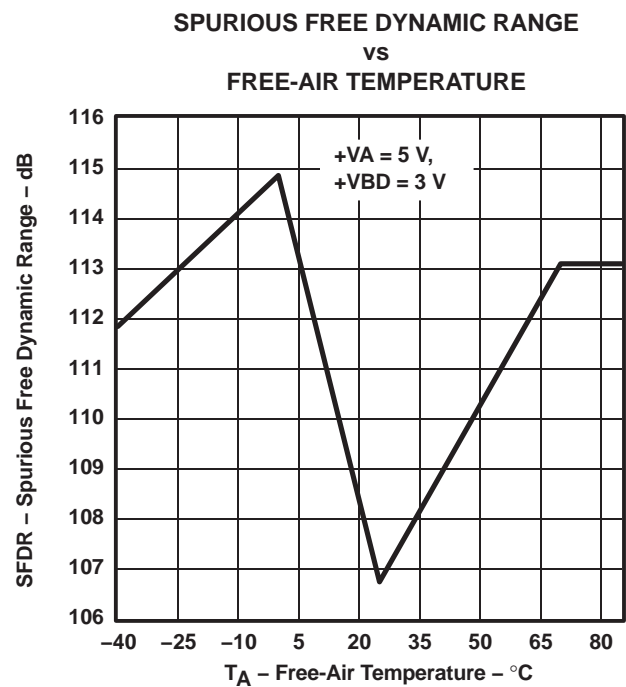

Figure 9

† At -40°C to 85°C , $+V_A = 5\text{ V}$, $+V_{BD} = 5\text{ V}$, $\text{REFIN} = 4.096\text{ V}$ and $f_{\text{sample}} = 500\text{ kHz}$ (unless otherwise noted)

TYPICAL CHARACTERISTICS†

TOTAL HARMONIC DISTORTION
vs
FREE-AIR TEMPERATURE

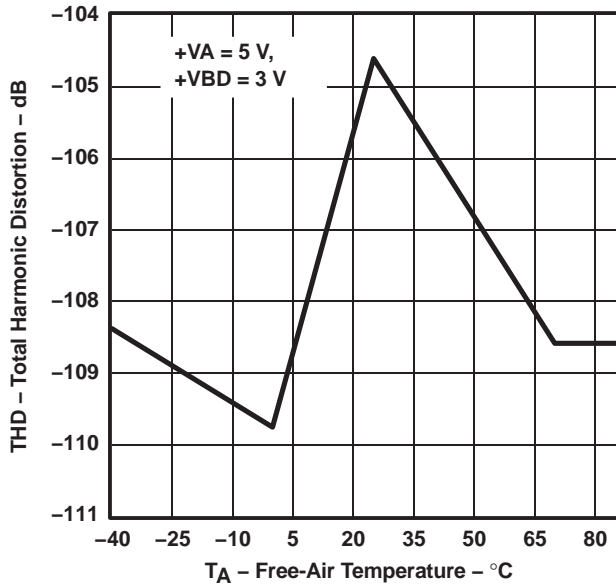

Figure 10

EFFECTIVE NUMBER OF BITS
vs
FREE-AIR TEMPERATURE

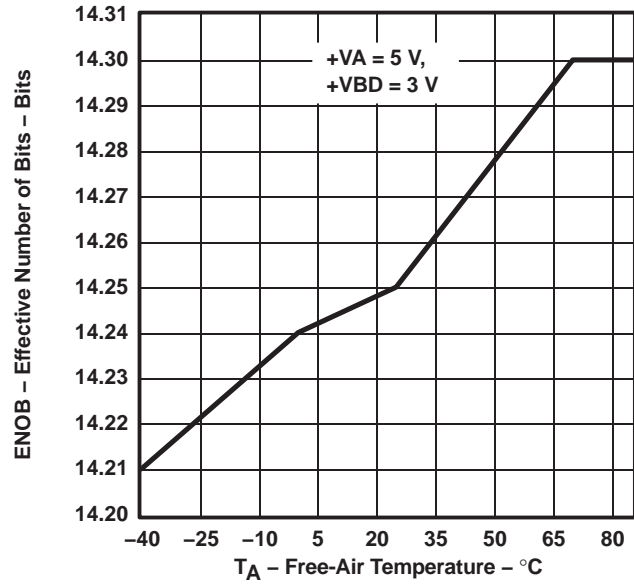

Figure 11

SIGNAL-TO-NOISE RATIO
vs
INPUT FREQUENCY

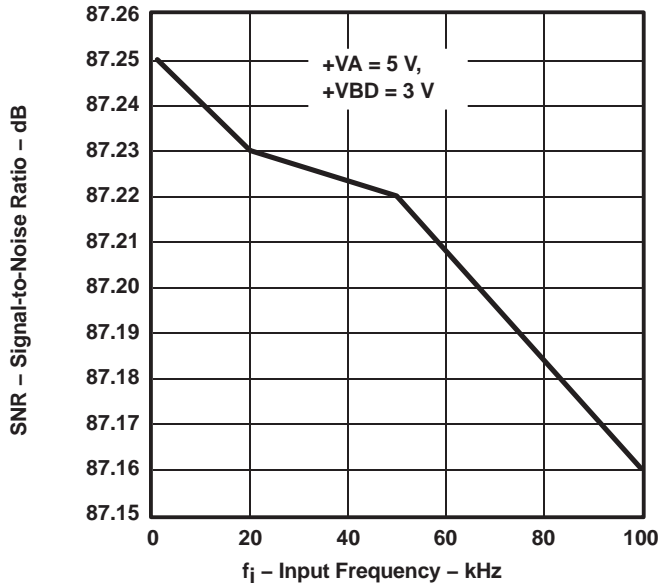

Figure 12

SIGNAL-TO-NOISE + DISTORTION
vs
INPUT FREQUENCY

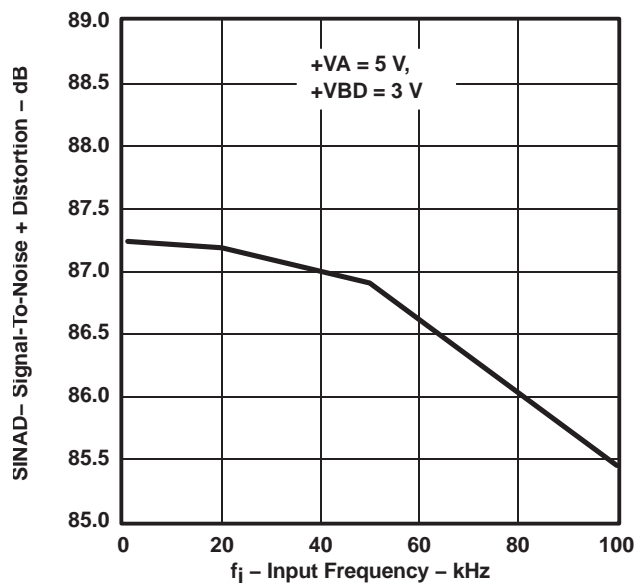

Figure 13

† At -40°C to 85°C, +VA = 5 V, +VBD = 5 V, REFIN = 4.096 V and $f_{\text{sample}} = 500$ kHz (unless otherwise noted)

TYPICAL CHARACTERISTICS†

EFFECTIVE NUMBER OF BITS
vs
INPUT FREQUENCY

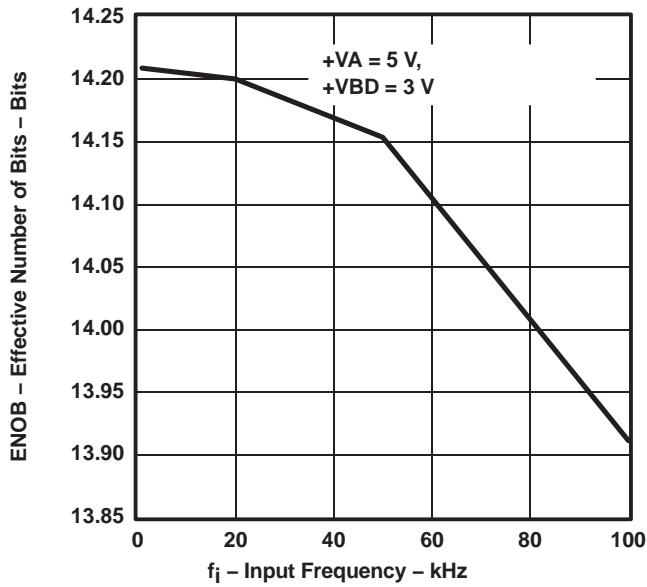

Figure 14

SPURIOUS FREE DYNAMIC RANGE
vs
INPUT FREQUENCY

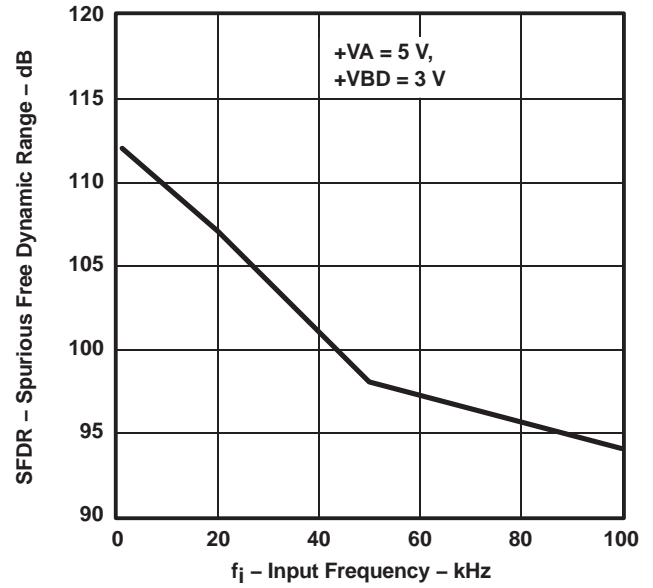

Figure 15

TOTAL HARMONIC DISTORTION
vs
INPUT FREQUENCY

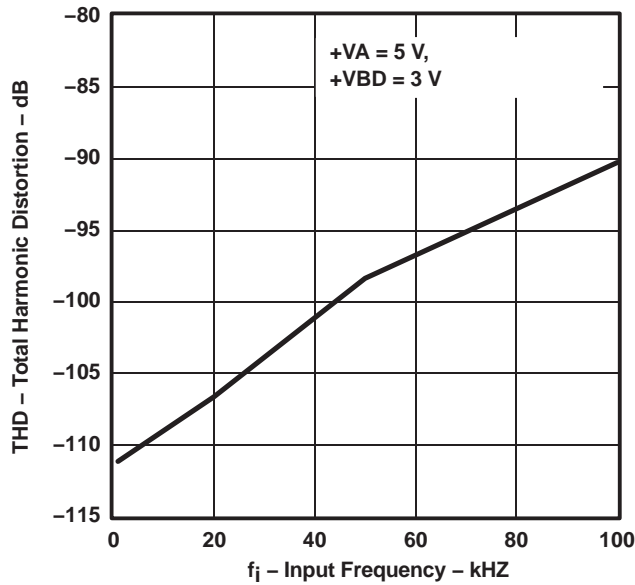

Figure 16

SUPPLY CURRENT
vs
SAMPLE RATE

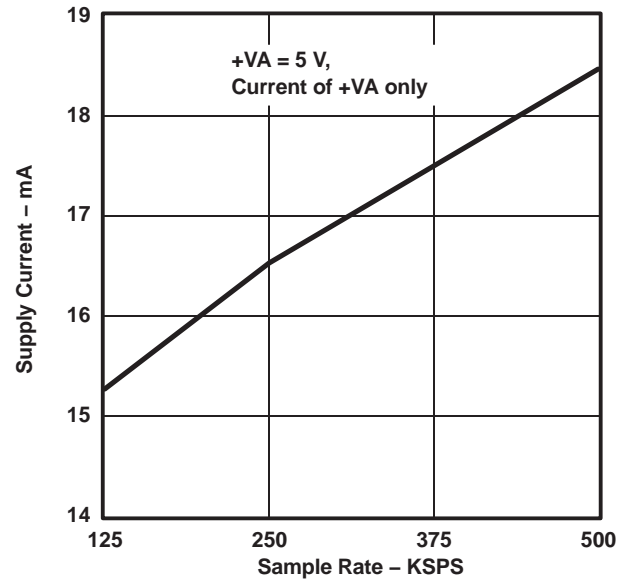

Figure 17

† At -40°C to 85°C, +VA = 5 V, +VBD = 5 V, REFIN = 4.096 V and $f_{\text{sample}} = 500$ kHz (unless otherwise noted)

TYPICAL CHARACTERISTICS†

INTEGRAL NONLINEARITY
vs
SAMPLE RATE

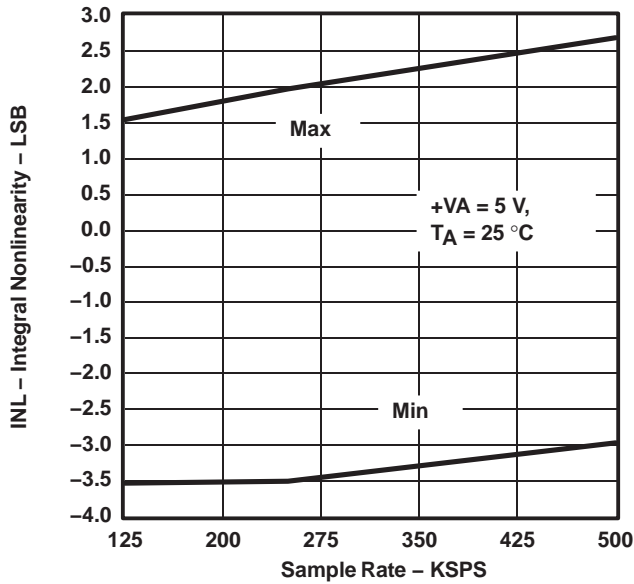

Figure 18

DIFFERENTIAL NONLINEARITY
vs
SAMPLE RATE

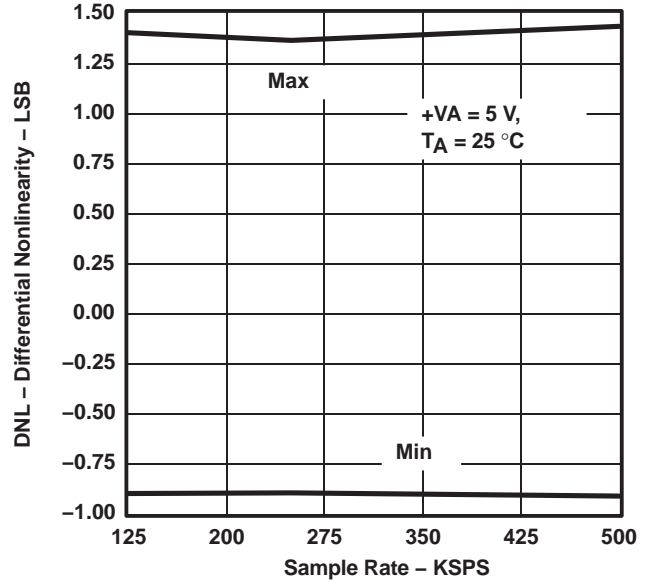

Figure 19

GAIN ERROR
vs
SUPPLY VOLTAGE

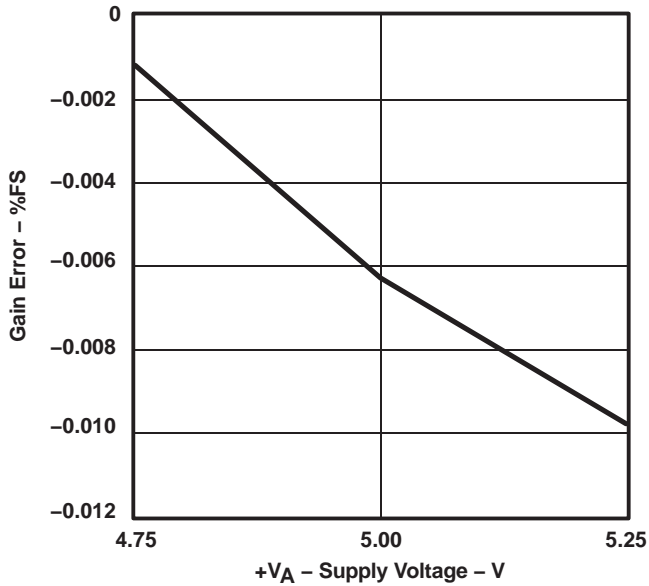

Figure 20

OFFSET VOLTAGE
vs
SUPPLY VOLTAGE

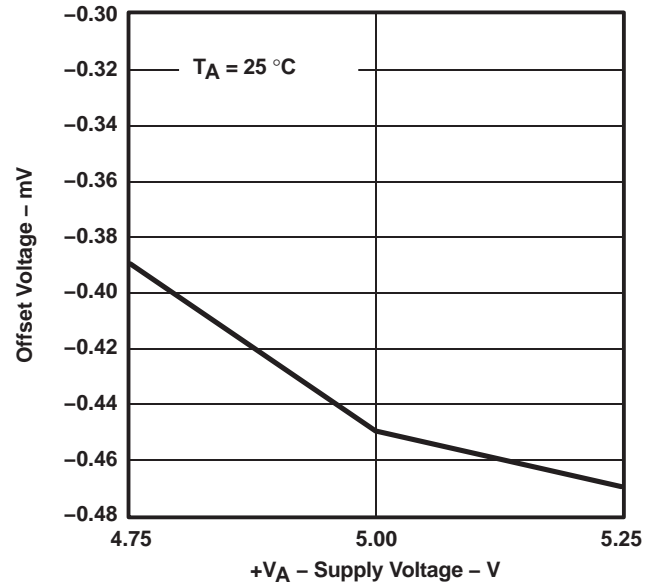

Figure 21

† At -40°C to 85°C, +VA = 5 V, +VBD = 5 V, REFIN = 4.096 V and f_{sample} = 500 kHz (unless otherwise noted)

TYPICAL CHARACTERISTICS†

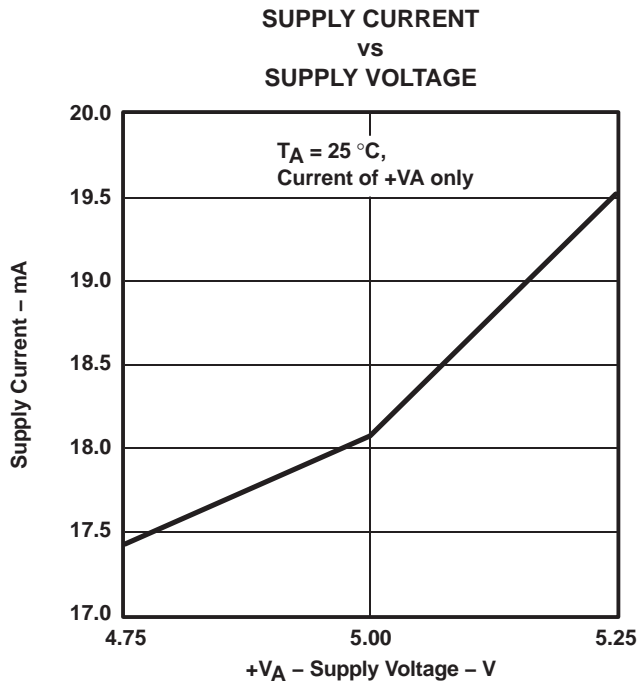

Figure 22

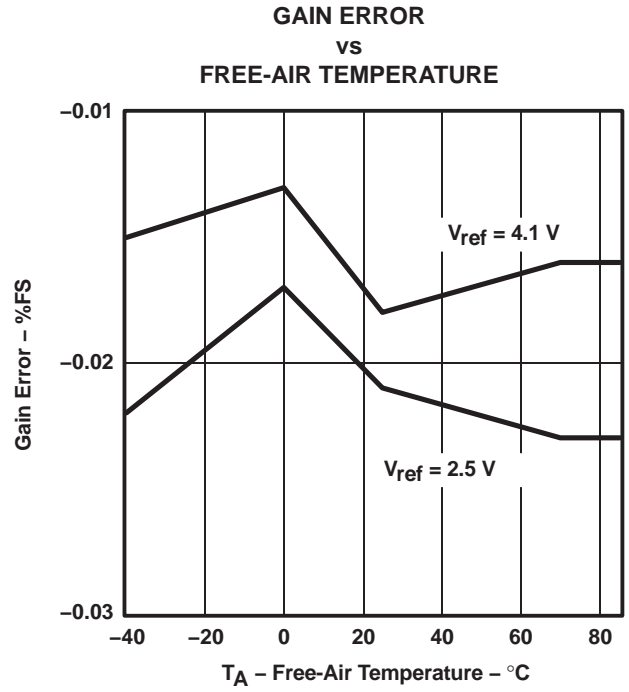

Figure 23

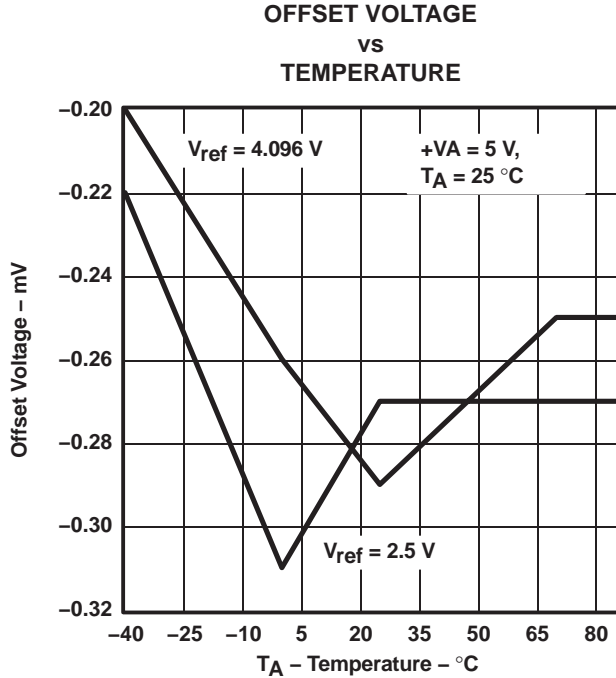

Figure 24

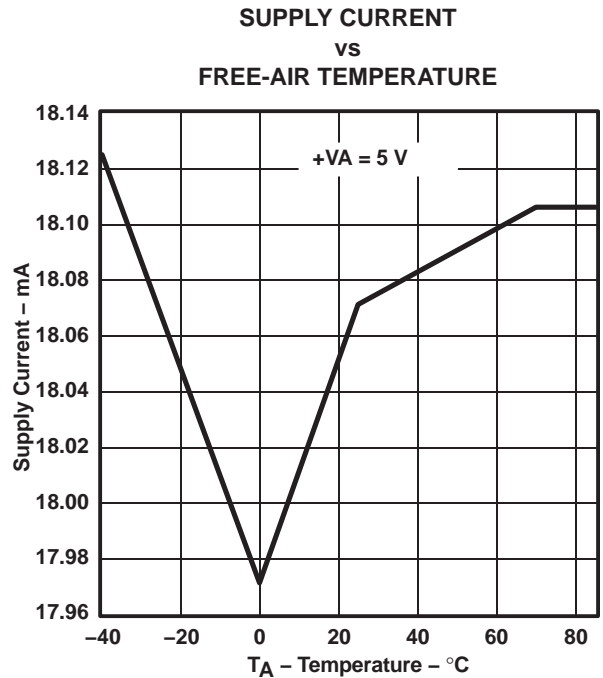

Figure 25

† At -40°C to 85°C, +VA = 5 V, +VBD = 5 V, REFIN = 4.096 V and f_{sample} = 500 kHz (unless otherwise noted)

TYPICAL CHARACTERISTICS†

DIFFERENTIAL NONLINEARITY (Max)
vs
TEMPERATURE

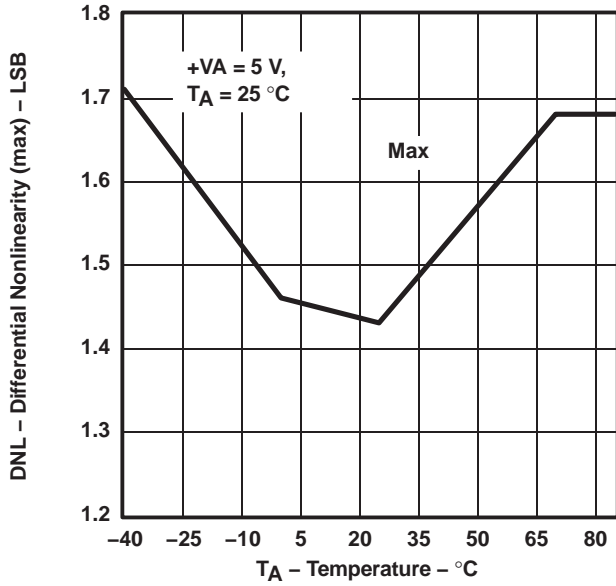

Figure 26

DIFFERENTIAL NONLINEARITY (Min)
vs
TEMPERATURE

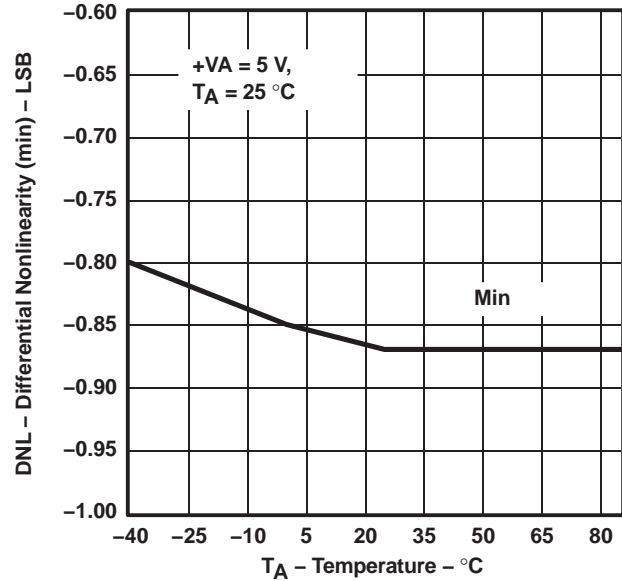

Figure 27

INTEGRAL NONLINEARITY (Max)
vs
TEMPERATURE

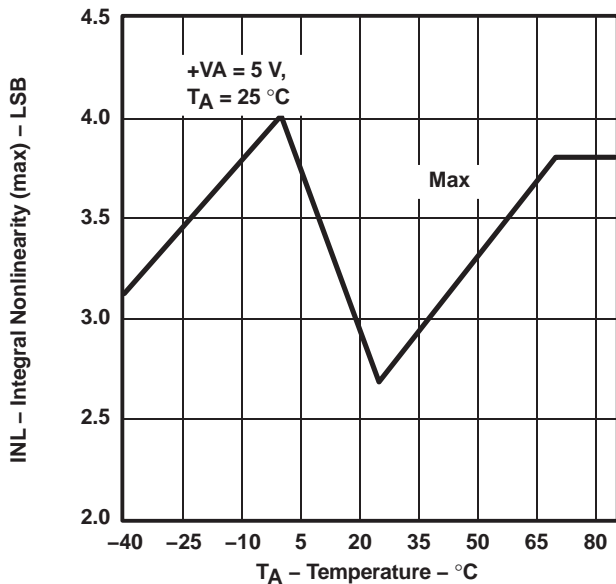

Figure 28

INTEGRAL NONLINEARITY (Min)
vs
TEMPERATURE

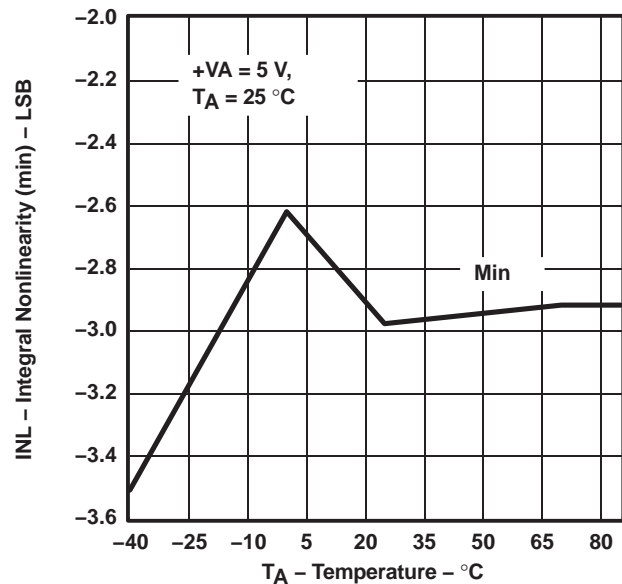
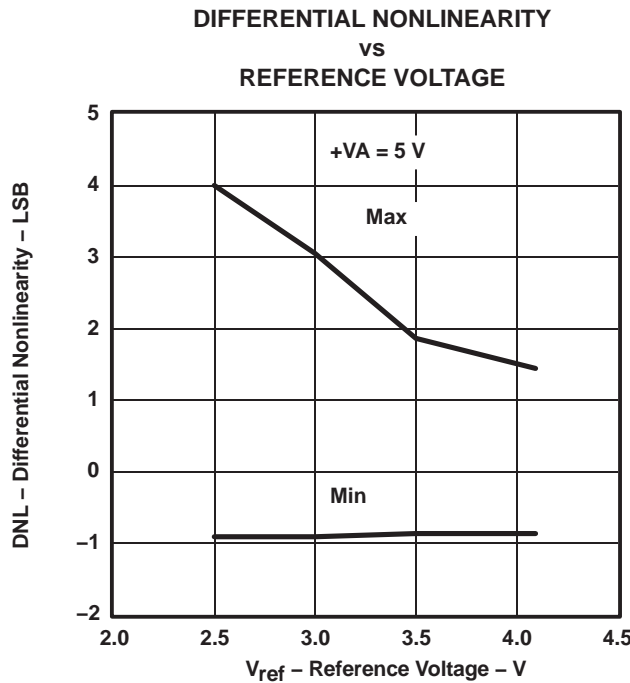
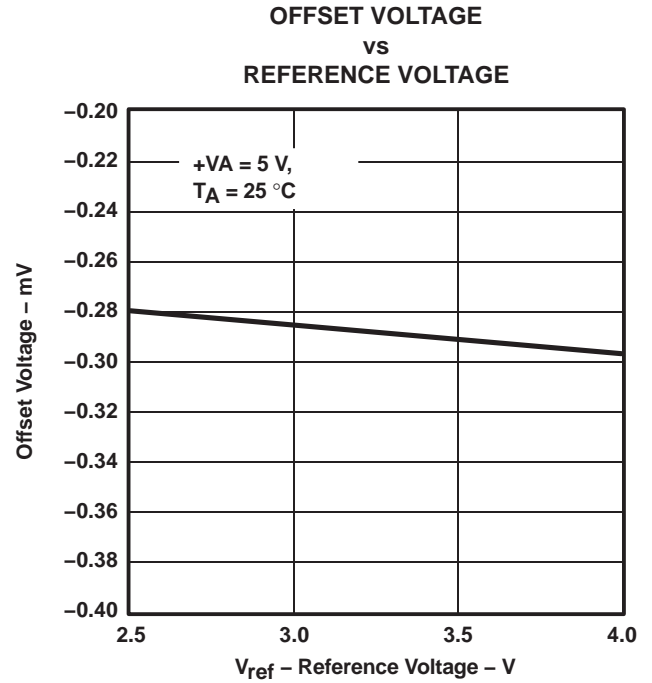
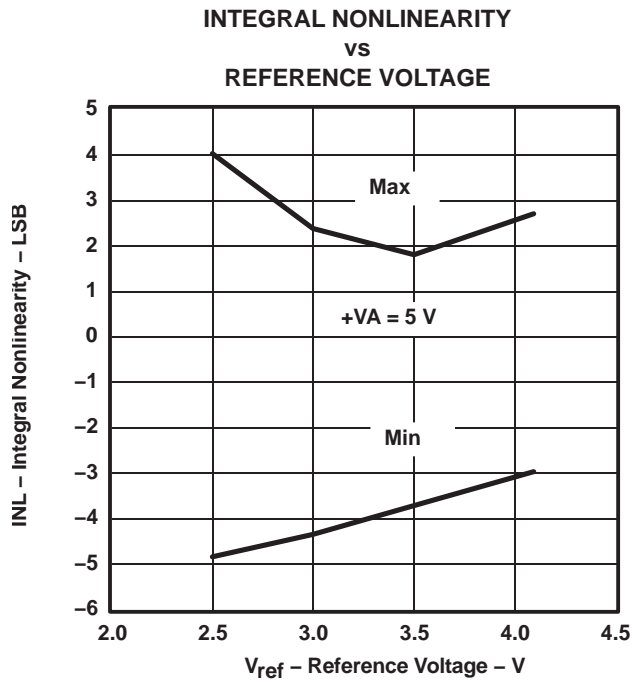

Figure 29

† At -40°C to 85°C, +VA = 5 V, +VBD = 5 V, REFIN = 4.096 V and f_{sample} = 500 kHz (unless otherwise noted)

TYPICAL CHARACTERISTICS†



† At -40°C to 85°C, +VA = 5 V, +VBD = 5 V, REFIN = 4.096 V and f_{sample} = 500 kHz (unless otherwise noted)

TYPICAL CHARACTERISTICS†

DIFFERENTIAL LINEARITY ERROR
vs
CODE

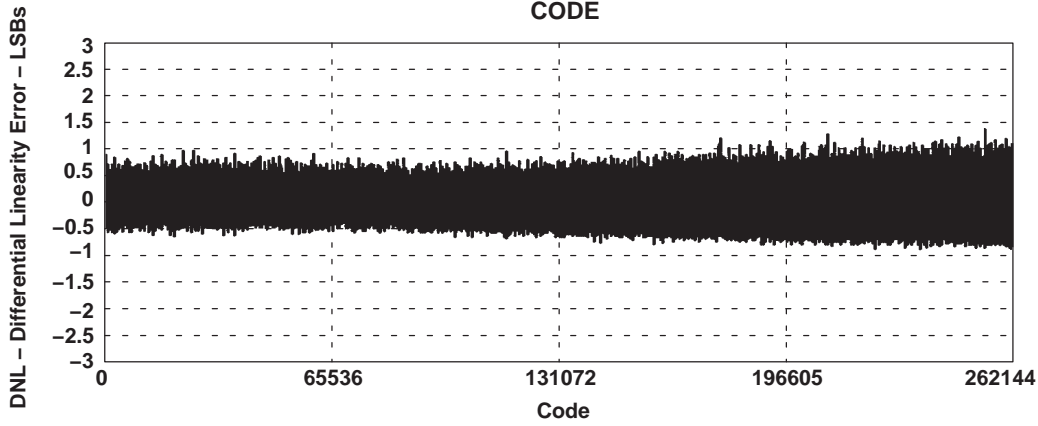

Figure 33

INTEGRAL LINEARITY ERROR
vs
CODE

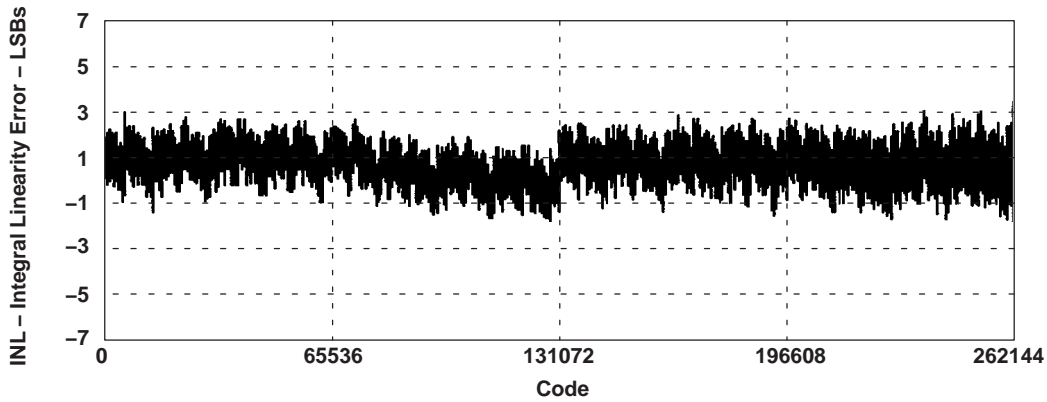

Figure 34

FFT SPECTRAL RESPONSE (100 kHz Input)

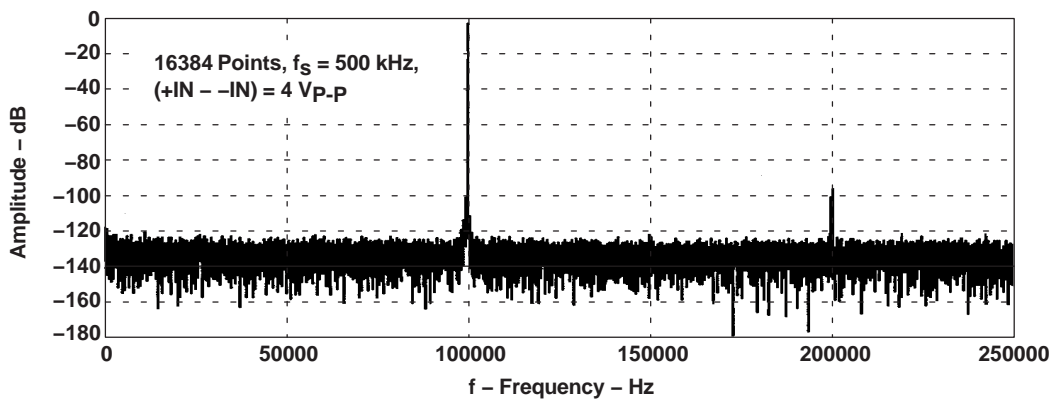

Figure 35

† At -40°C to 85°C , $+V_A = 5$ V, $+V_{BD} = 5$ V, $\text{REFIN} = 4.096$ V and $f_{\text{sample}} = 500$ kHz (unless otherwise noted)

TYPICAL CHARACTERISTICS†

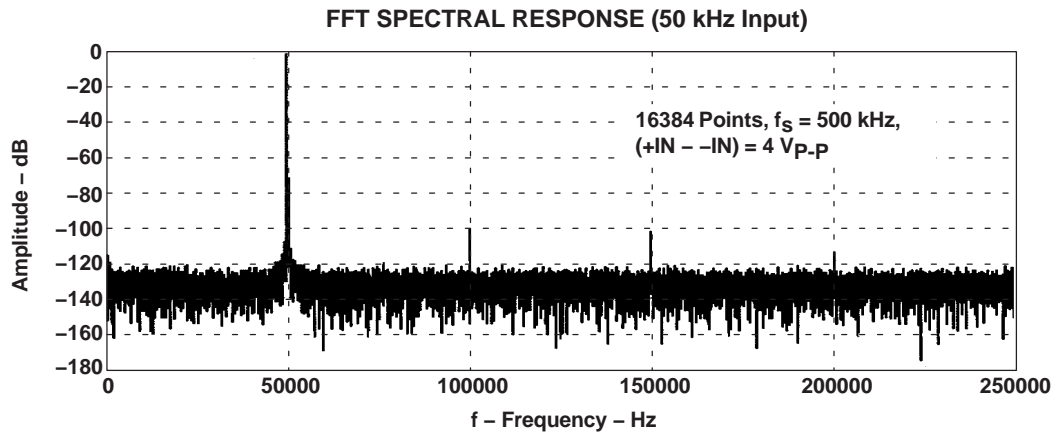

Figure 36

† At -40°C to 85°C , $+V_A = 5$ V, $+V_{BD} = 5$ V, $\text{REFIN} = 4.096$ V and $f_{\text{sample}} = 500$ kHz (unless otherwise noted)

APPLICATION INFORMATION

MICROCONTROLLER INTERFACING

ADS8383 to 8-Bit Microcontroller Interface

Figure 37 shows a parallel interface between the ADS8383 and a typical microcontroller using the 8-bit data bus. The BUSY signal is used as a falling-edge interrupt to the microprocessor.

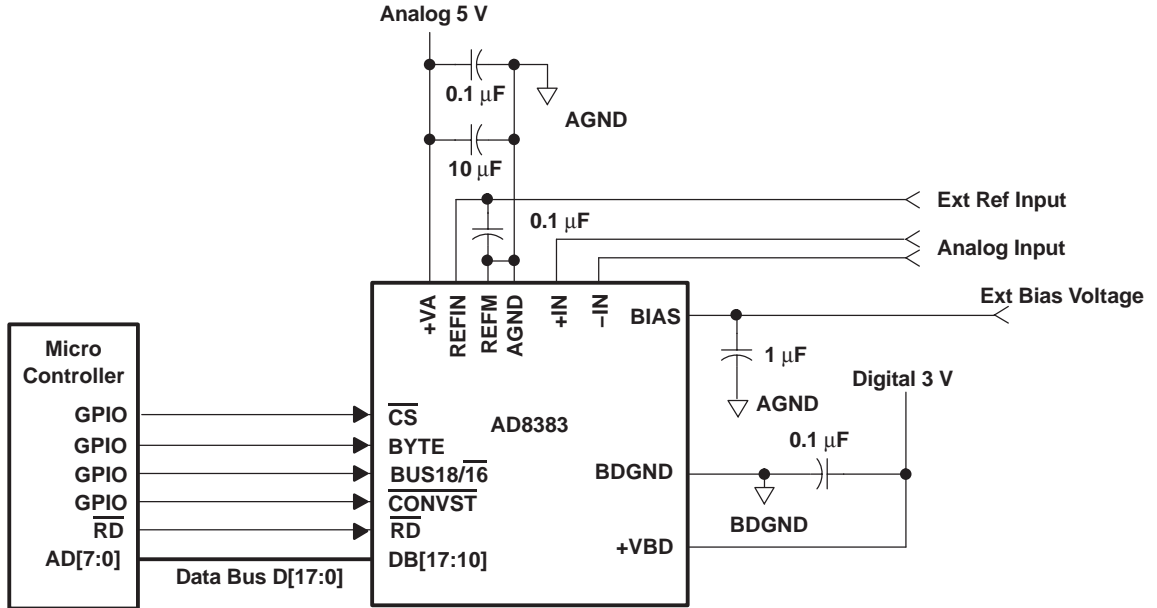

Figure 37. ADS8383 Application Circuitry

PRINCIPLES OF OPERATION

The ADS8383 is a high-speed successive approximation register (SAR) analog-to-digital converter (ADC). The architecture is based on charge redistribution which inherently includes a sample/hold function. See Figure 37 for the application circuit for the ADS8383.

The conversion clock is generated internally. The conversion time of 1.52 μs is capable of sustaining a 500-kHz throughput.

The analog input is provided to two input pins: +IN and –IN. When a conversion is initiated, the differential input on these pins is sampled on the internal capacitor array. While a conversion is in progress, both inputs are disconnected from any internal function.

REFERENCE

The ADS8383 can operate with an external 4.096-V reference for a corresponding full-scale range of 4.096 V.

BIASING THE ADS8383

The ADS8383 requires an external 2.048-V bandgap reference to generate the bias currents for internal circuitry. Figure 38 shows the internal circuitry used to generate the bias currents. The bias generation circuit also pumps 100 μA (150 μA max) out from the BIAS pin. The bandgap used should be capable of sinking 100 μA (150 μA max) while holding the voltage on the pin steady. Table 1 shows the specification of the bandgap used to drive the BIAS pin of the ADS8383.

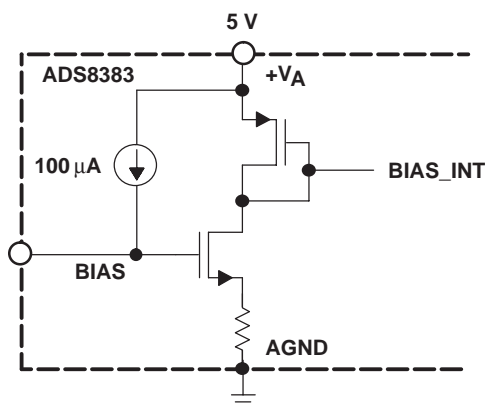

Figure 38. Bias Current Generation

Table 1. Bias Specifications

PARAMETER	MIN	TYP	MAX	UNITS
Output Voltage	2	2.048	2.1	V
I_{sink}		100	150	μA

Any common bandgap like REF3020 can be used to drive the BIAS pin of the ADS8383. Figure 39 shows how REF3020 can be used with the ADS8383. A 1 μF decoupling capacitor is recommended between pins 2 and AGND of the ADS8383 for optimal performance.

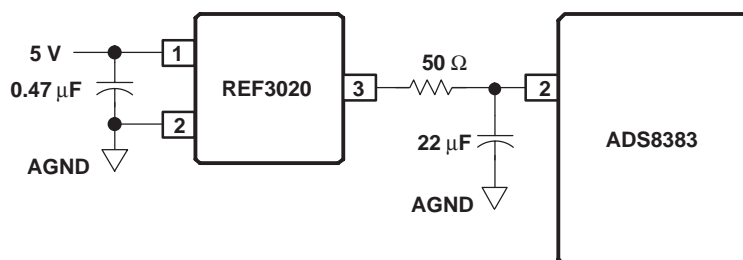

Figure 39. Using the REF3020 to Drive the ADS8383 BIAS Pin

ANALOG INPUT

When the converter enters the hold mode, the voltage difference between the +IN and –IN inputs is captured on the internal capacitor array. The voltage on the –IN input is limited between –0.2 V and 0.2 V, allowing the input to reject small signals which are common to both the +IN and –IN inputs. The +IN input has a range of –0.2 V to $V_{ref} + 0.2$ V. The input span (+IN – (–IN)) is limited to 0 V to V_{ref} .

The input current on the analog inputs depends upon a number of factors: sample rate, input voltage, and source impedance. Essentially, the current into the ADS8383 charges the internal capacitor array during the sample period. After this capacitance has been fully charged, there is no further input current. The source of the analog input voltage must be able to charge the input capacitance (45 pF) to an 18-bit settling level within the acquisition time (400 ns) of the device. When the converter goes into the hold mode, the input impedance is greater than 1 G Ω .

Care must be taken regarding the absolute analog input voltage. To maintain the linearity of the converter, the +IN and –IN inputs and the span (+IN – (–IN)) should be within the limits specified. Outside of these ranges, the converter's linearity may not meet specifications. To minimize noise, low bandwidth input signals with low-pass filters should be used.

Care should be taken to ensure that the output impedance of the sources driving the +IN and –IN inputs are matched. If this is not observed, the two inputs could have different settling times. This may result in offset error, gain error, and linearity error which changes with temperature and input voltage.

DIGITAL INTERFACE

Timing And Control

See the timing diagrams in the specifications section for detailed information on timing signals and their requirements.

The ADS8383 uses an internal oscillator generated clock which controls the conversion rate and in turn the throughput of the converter. No external clock input is required.

Conversions are initiated by bringing the $\overline{\text{CONVST}}$ pin low for a minimum of 20 ns (after the 20 ns minimum requirement has been met, the $\overline{\text{CONVST}}$ pin can be brought high), while $\overline{\text{CS}}$ is low. The ADS8383 switches from the sample to the hold mode on the falling edge of the $\overline{\text{CONVST}}$ command. A clean and low jitter falling edge of this signal is important to the performance of the converter. The BUSY output is brought high immediately following $\overline{\text{CONVST}}$ going low. BUSY stays high through the conversion process and returns low when the conversion has ended.

Sampling starts with the falling edge of the BUSY signal when $\overline{\text{CS}}$ is tied low or starts with the falling edge of $\overline{\text{CS}}$ when BUSY is low.

Both $\overline{\text{RD}}$ and $\overline{\text{CS}}$ can be high during and before a conversion with one exception ($\overline{\text{CS}}$ must be low when $\overline{\text{CONVST}}$ goes low to initiate a conversion). Both the $\overline{\text{RD}}$ and $\overline{\text{CS}}$ pins are brought low in order to enable the parallel output bus with the conversion.

Reading Data

The ADS8383 outputs full parallel data in straight binary format as shown in Table 2. The parallel output is active when $\overline{\text{CS}}$ and $\overline{\text{RD}}$ are both low. There is a minimal quiet zone requirement around the falling edge of $\overline{\text{CONVST}}$. This is 125 ns prior to the falling edge of $\overline{\text{CONVST}}$ and 40 ns after the falling edge. No data read should be attempted within this zone. Any other combination of $\overline{\text{CS}}$ and $\overline{\text{RD}}$ sets the parallel output to 3-state. BYTE and BUS18/16 are used for multiword read operations. BYTE is used whenever lower bits on the bus are output on the higher byte of the bus. BUS18/16 is used whenever the last two bits on the 18-bit bus is output on either bytes of the higher 16-bit bus. Refer to Table 2 for ideal output codes.

Table 2. Ideal Input Voltages and Output Codes

DESCRIPTION	ANALOG VALUE	DIGITAL OUTPUT STRAIGHT BINARY	
		BINARY CODE	HEX CODE
Full scale range	+V _{ref}		
Least significant bit (LSB)	+V _{ref} /262144		
Full scale	+V _{ref} – 1 LSB	11 1111 1111 1111 1111	3FFFF
Midscale	+V _{ref} /2	10 0000 0000 0000 0000	20000
Midscale – 1 LSB	+V _{ref} /2 – 1 LSB	01 1111 1111 1111 1111	1FFFF
Zero	0 V	00 0000 0000 0000 0000	00000

The output data is a full 18-bit word (D17–D0) on DB17–DB0 pins (MSB–LSB) if both BUS18/16 and BYTE are low.

The result may also be read on a 16-bit bus by using only pins DB17–DB2. In this case two reads are necessary: the first as before, leaving both BUS18/16 and BYTE low and reading the 16 most significant bits (D17–D2) on pins DB17–DB2, then bringing BUS18/16 high while holding BYTE low. When BUS18/16 is high, the lower two bits (D1–D0) appear on pins DB3–DB2.

The result may also be read on an 8-bit bus for convenience. This is done by using only pins DB17–DB10. In this case three reads are necessary: the first as before, leaving both BUS18/16 and BYTE low and reading the 8 most significant bits on pins DB17–DB10, then bringing BYTE high while holding BUS18/16 low. When BYTE is high, the medium bits (D9–D2) appear on pins DB17–DB10. The last read is done by bringing BUS18/16 high while holding BYTE high. When BUS18/16 is high, the lower two bits (D1–D0) appear on pins DB11–DB10. The last read cycle is not necessary if only the first 16 most significant bits are of interest.

All of these multiword read operations can be performed with multiple active \overline{RD} (toggling) or with \overline{RD} held low for simplicity. This is referred to as the AUTO READ operation. Note that \overline{RD} may not be tied to BDGND permanently due to the requirement of power-on initialization.

Table 3. Conversion Data Read Out

BYTE	BUS18/16	DATA READ OUT				
		DB17–DB12 PINS	DB11–DB10 PINS	DB9–DB4 PINS	DB3–DB2 PINS	DB1–DB0 PINS
High	High	All One's	D1–D0	All One's	All One's	All One's
Low	High	All One's	All One's	All One's	D1–D0	All One's
High	Low	D9–D4	D3–D2	All One's	All One's	All One's
Low	Low	D17–D12	D11–D10	D9–D4	D3–D2	D1–D0

INITIALIZATION

At first power on there are three conversion cycles required. If an ANT conversion cycle is attempted before the initialization is completed, the first three conversion cycles will not produce valid results. These are used to load factory trimming data for a specific device to ensure high accuracy of the converter. Because of this requirement, the \overline{RD} pin cannot be tied permanently to BDGND. System designers can still achieve the AUTO READ function if the power-on requirement is satisfied.

LAYOUT

For optimum performance, care should be taken with the physical layout of the ADS8383 circuitry.

As the ADS8383 offers single-supply operation, it will often be used in close proximity with digital logic, microcontrollers, microprocessors, and digital signal processors. The more digital logic present in the design and the higher the switching speed, the more difficult it is to achieve good performance from the converter.

The basic SAR architecture is sensitive to glitches or sudden changes on the power supply, reference, ground connections and digital inputs that occur just prior to latching the output of the analog comparator. Thus, driving any single conversion for an n-bit SAR converter, there are at least n *windows* in which large external transient voltages can affect the conversion result. Such glitches might originate from switching power supplies, nearby digital logic, or high power devices.

The degree of error in the digital output depends on the reference voltage, layout, and the exact timing of the external event.

On average, the ADS8383 draws very little current from an external reference as the reference voltage is internally buffered. If the reference voltage is external and originates from an op amp, make sure that it can drive the bypass capacitor or capacitors without oscillation. A 0.1- μ F bypass capacitor is recommended from pin 1 (REFIN) directly to pin 48 (REFM). REFM and AGND should be shorted on the same ground plane under the device.

The AGND and BDGND pins should be connected to a clean ground point. In all cases, this should be the analog ground. Avoid connections which are too close to the grounding point of a microcontroller or digital signal processor. If required, run a ground trace directly from the converter to the power supply entry point. The ideal layout consists of an analog ground plane dedicated to the converter and associated analog circuitry.

As with the AGND connections, +VA should be connected to a 5-V power supply plane or trace that is separate from the connection for digital logic until they are connected at the power entry point. Power to the ADS8383 should be clean and well bypassed. A 0.1- μ F ceramic bypass capacitor should be placed as close to the device as possible. See Table 4 for the placement of the capacitor. In addition, a 1- μ F to 10- μ F capacitor is recommended. In some situations, additional bypassing may be required, such as a 100- μ F electrolytic capacitor or even a Pi filter made up of inductors and capacitors—all designed to essentially low-pass filter the 5-V supply, removing the high frequency noise.

Table 4. Power Supply Decoupling Capacitor Placement

POWER SUPPLY PLANE	CONVERTER ANALOG SIDE	CONVERTER DIGITAL SIDE
SUPPLY PINS		
Pin pairs that require shortest path to decoupling capacitors	(4,5), (8,9), (10,11), (13,15), (43,44), (45,46)	(24,25)
Pins that require no decoupling	12, 14	37

PACKAGING INFORMATION

Orderable Device	Status (1)	Package Type	Package Drawing	Pins	Package Qty	Eco Plan (2)	Lead/Ball Finish (6)	MSL Peak Temp (3)	Op Temp (°C)	Device Marking (4/5)	Samples
ADS8383IBPFBT	ACTIVE	TQFP	PFB	48	250	Green (RoHS & no Sb/Br)	CU NIPDAU	Level-2-260C-1 YEAR	-40 to 85	ADS8383I B	

(1) The marketing status values are defined as follows:

ACTIVE: Product device recommended for new designs.

LIFEBUY: TI has announced that the device will be discontinued, and a lifetime-buy period is in effect.

NRND: Not recommended for new designs. Device is in production to support existing customers, but TI does not recommend using this part in a new design.

PREVIEW: Device has been announced but is not in production. Samples may or may not be available.

OBSELETE: TI has discontinued the production of the device.

(2) Eco Plan - The planned eco-friendly classification: Pb-Free (RoHS), Pb-Free (RoHS Exempt), or Green (RoHS & no Sb/Br) - please check <http://www.ti.com/productcontent> for the latest availability information and additional product content details.

TBD: The Pb-Free/Green conversion plan has not been defined.

Pb-Free (RoHS): TI's terms "Lead-Free" or "Pb-Free" mean semiconductor products that are compatible with the current RoHS requirements for all 6 substances, including the requirement that lead not exceed 0.1% by weight in homogeneous materials. Where designed to be soldered at high temperatures, TI Pb-Free products are suitable for use in specified lead-free processes.

Pb-Free (RoHS Exempt): This component has a RoHS exemption for either 1) lead-based flip-chip solder bumps used between the die and package, or 2) lead-based die adhesive used between the die and leadframe. The component is otherwise considered Pb-Free (RoHS compatible) as defined above.

Green (RoHS & no Sb/Br): TI defines "Green" to mean Pb-Free (RoHS compatible), and free of Bromine (Br) and Antimony (Sb) based flame retardants (Br or Sb do not exceed 0.1% by weight in homogeneous material)

(3) MSL, Peak Temp. - The Moisture Sensitivity Level rating according to the JEDEC industry standard classifications, and peak solder temperature.

(4) There may be additional marking, which relates to the logo, the lot trace code information, or the environmental category on the device.

(5) Multiple Device Markings will be inside parentheses. Only one Device Marking contained in parentheses and separated by a "~" will appear on a device. If a line is indented then it is a continuation of the previous line and the two combined represent the entire Device Marking for that device.

(6) Lead/Ball Finish - Orderable Devices may have multiple material finish options. Finish options are separated by a vertical ruled line. Lead/Ball Finish values may wrap to two lines if the finish value exceeds the maximum column width.

Important Information and Disclaimer: The information provided on this page represents TI's knowledge and belief as of the date that it is provided. TI bases its knowledge and belief on information provided by third parties, and makes no representation or warranty as to the accuracy of such information. Efforts are underway to better integrate information from third parties. TI has taken and continues to take reasonable steps to provide representative and accurate information but may not have conducted destructive testing or chemical analysis on incoming materials and chemicals. TI and TI suppliers consider certain information to be proprietary, and thus CAS numbers and other limited information may not be available for release.

In no event shall TI's liability arising out of such information exceed the total purchase price of the TI part(s) at issue in this document sold by TI to Customer on an annual basis.

TAPE AND REEL INFORMATION

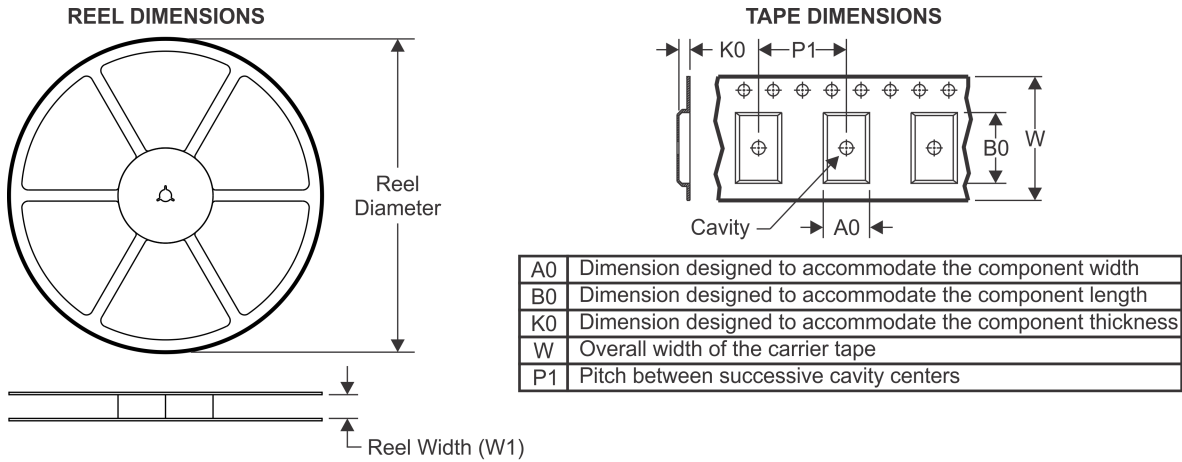

QUADRANT ASSIGNMENTS FOR PIN 1 ORIENTATION IN TAPE

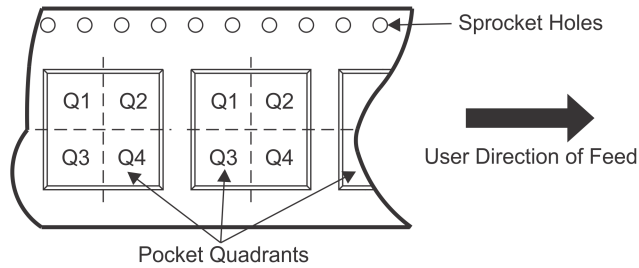

*All dimensions are nominal

Device	Package Type	Package Drawing	Pins	SPQ	Reel Diameter (mm)	Reel Width W1 (mm)	A0 (mm)	B0 (mm)	K0 (mm)	P1 (mm)	W (mm)	Pin1 Quadrant
ADS8383IBPFBT	TQFP	PFB	48	250	180.0	16.4	9.6	9.6	1.5	12.0	16.0	Q2

TAPE AND REEL BOX DIMENSIONS

*All dimensions are nominal

Device	Package Type	Package Drawing	Pins	SPQ	Length (mm)	Width (mm)	Height (mm)
ADS8383IBPFBT	TQFP	PFB	48	250	213.0	191.0	55.0

PFB (S-PQFP-G48)

PLASTIC QUAD FLATPACK

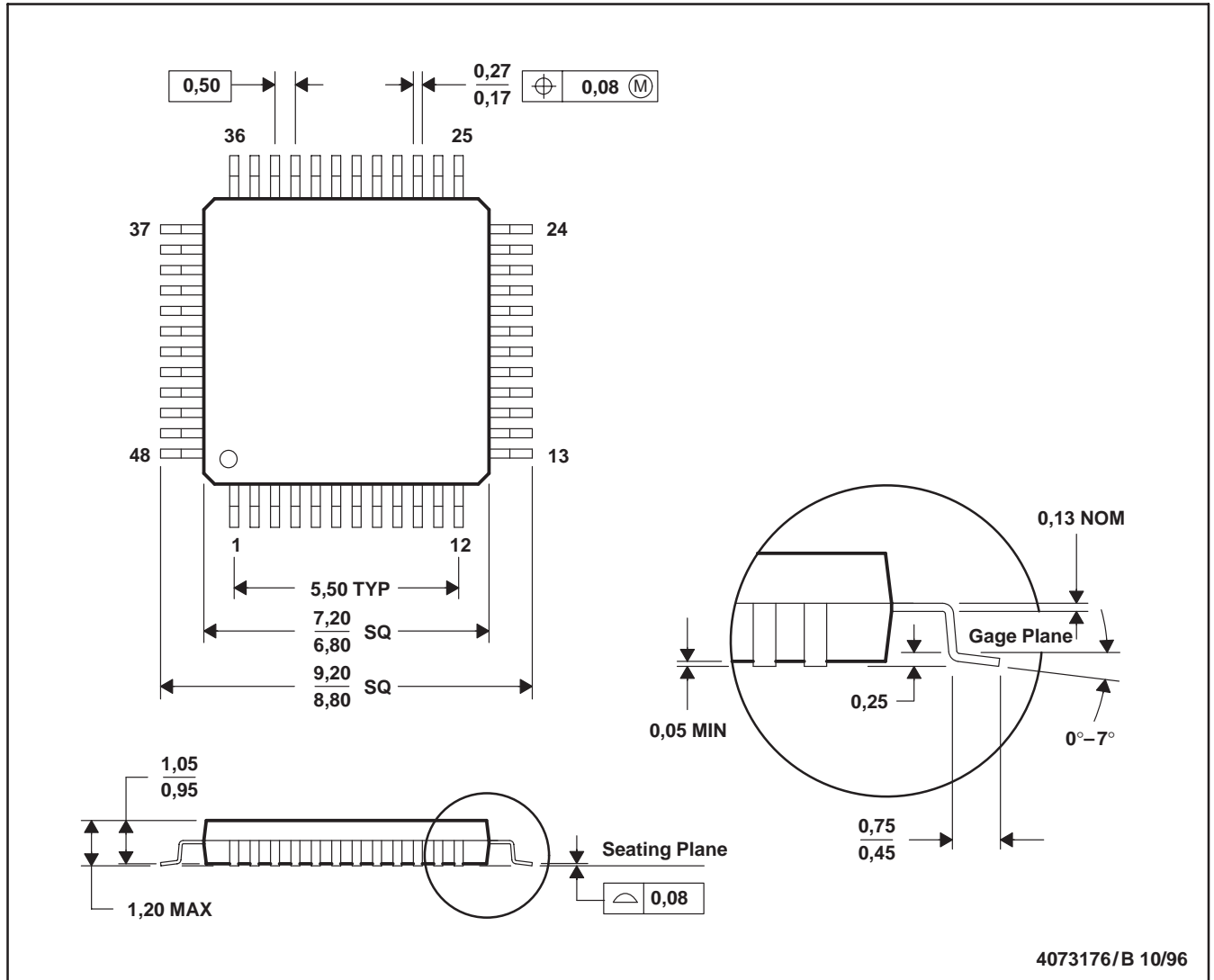

- NOTES: A. All linear dimensions are in millimeters.
 B. This drawing is subject to change without notice.
 C. Falls within JEDEC MS-026

PFB (S-PQFP-G48)

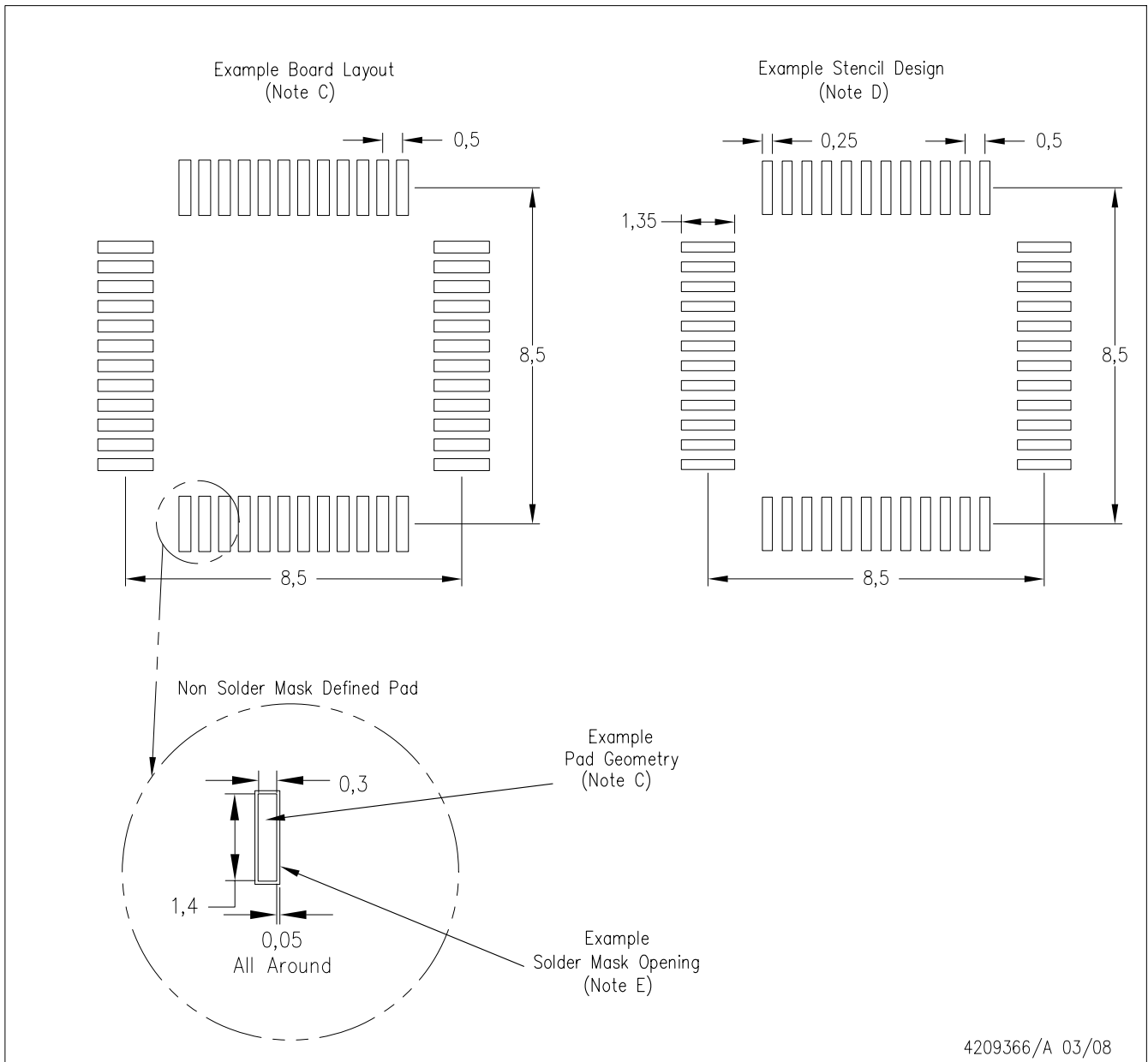

- NOTES:
- A. All linear dimensions are in millimeters.
 - B. This drawing is subject to change without notice.
 - C. Publication IPC-7351 is recommended for alternate designs.
 - D. Laser cutting apertures with trapezoidal walls and also rounding corners will offer better paste release. Customers should contact their board assembly site for stencil design recommendations. Refer to IPC-7525.
 - E. Customers should contact their board fabrication site for solder mask tolerances between and around signal pads.

IMPORTANT NOTICE

Texas Instruments Incorporated and its subsidiaries (TI) reserve the right to make corrections, enhancements, improvements and other changes to its semiconductor products and services per JESD46, latest issue, and to discontinue any product or service per JESD48, latest issue. Buyers should obtain the latest relevant information before placing orders and should verify that such information is current and complete. All semiconductor products (also referred to herein as "components") are sold subject to TI's terms and conditions of sale supplied at the time of order acknowledgment.

TI warrants performance of its components to the specifications applicable at the time of sale, in accordance with the warranty in TI's terms and conditions of sale of semiconductor products. Testing and other quality control techniques are used to the extent TI deems necessary to support this warranty. Except where mandated by applicable law, testing of all parameters of each component is not necessarily performed.

TI assumes no liability for applications assistance or the design of Buyers' products. Buyers are responsible for their products and applications using TI components. To minimize the risks associated with Buyers' products and applications, Buyers should provide adequate design and operating safeguards.

TI does not warrant or represent that any license, either express or implied, is granted under any patent right, copyright, mask work right, or other intellectual property right relating to any combination, machine, or process in which TI components or services are used. Information published by TI regarding third-party products or services does not constitute a license to use such products or services or a warranty or endorsement thereof. Use of such information may require a license from a third party under the patents or other intellectual property of the third party, or a license from TI under the patents or other intellectual property of TI.

Reproduction of significant portions of TI information in TI data books or data sheets is permissible only if reproduction is without alteration and is accompanied by all associated warranties, conditions, limitations, and notices. TI is not responsible or liable for such altered documentation. Information of third parties may be subject to additional restrictions.

Resale of TI components or services with statements different from or beyond the parameters stated by TI for that component or service voids all express and any implied warranties for the associated TI component or service and is an unfair and deceptive business practice. TI is not responsible or liable for any such statements.

Buyer acknowledges and agrees that it is solely responsible for compliance with all legal, regulatory and safety-related requirements concerning its products, and any use of TI components in its applications, notwithstanding any applications-related information or support that may be provided by TI. Buyer represents and agrees that it has all the necessary expertise to create and implement safeguards which anticipate dangerous consequences of failures, monitor failures and their consequences, lessen the likelihood of failures that might cause harm and take appropriate remedial actions. Buyer will fully indemnify TI and its representatives against any damages arising out of the use of any TI components in safety-critical applications.

In some cases, TI components may be promoted specifically to facilitate safety-related applications. With such components, TI's goal is to help enable customers to design and create their own end-product solutions that meet applicable functional safety standards and requirements. Nonetheless, such components are subject to these terms.

No TI components are authorized for use in FDA Class III (or similar life-critical medical equipment) unless authorized officers of the parties have executed a special agreement specifically governing such use.

Only those TI components which TI has specifically designated as military grade or "enhanced plastic" are designed and intended for use in military/aerospace applications or environments. Buyer acknowledges and agrees that any military or aerospace use of TI components which have **not** been so designated is solely at the Buyer's risk, and that Buyer is solely responsible for compliance with all legal and regulatory requirements in connection with such use.

TI has specifically designated certain components as meeting ISO/TS16949 requirements, mainly for automotive use. In any case of use of non-designated products, TI will not be responsible for any failure to meet ISO/TS16949.

Products

Audio	www.ti.com/audio
Amplifiers	amplifier.ti.com
Data Converters	dataconverter.ti.com
DLP® Products	www.dlp.com
DSP	dsp.ti.com
Clocks and Timers	www.ti.com/clocks
Interface	interface.ti.com
Logic	logic.ti.com
Power Mgmt	power.ti.com
Microcontrollers	microcontroller.ti.com
RFID	www.ti-rfid.com
OMAP Applications Processors	www.ti.com/omap
Wireless Connectivity	www.ti.com/wirelessconnectivity

Applications

Automotive and Transportation	www.ti.com/automotive
Communications and Telecom	www.ti.com/communications
Computers and Peripherals	www.ti.com/computers
Consumer Electronics	www.ti.com/consumer-apps
Energy and Lighting	www.ti.com/energy
Industrial	www.ti.com/industrial
Medical	www.ti.com/medical
Security	www.ti.com/security
Space, Avionics and Defense	www.ti.com/space-avionics-defense
Video and Imaging	www.ti.com/video

TI E2E Community

e2e.ti.com

Looking for pricing, stock, or lifecycle information?

Click below to explore more details on WIN SOURCE:

 [View ADS8383IBPFBT on WIN SOURCE](#)

 [Texas Instruments](#) Information

Optimize Your Supply Chain with WIN SOURCE Solutions

-  Global Sourcing Solution
-  Obsolete Management
-  Cost Control Management
-  Shortage Management
-  Alternative Solution
-  Excess Inventory Management