



**THE DATASHEET OF
ADS8363SRHBR**



ADSxxx3 Dual, 1-MSPS, 16-, 14-, and 12-Bit, 4x2 or 2x2 Channel, Simultaneous Sampling Analog-to-Digital Converter

1 Features

- Eight Pseudo- or Four Fully-Differential Inputs
- Simultaneous Sampling of Two Channels
- Excellent AC Performance:
 - SNR:
 - 93 dB (ADS8363)
 - 85 dB (ADS7263)
 - 73 dB (ADS7223)
 - THD:
 - 98 dB (ADS8363)
 - 92 dB (ADS7263)
 - 86 dB (ADS7223)
- Dual Programmable and Buffered 2.5-V Reference Allows:
 - Two Different Input Voltage Range Settings
 - Two-Level PGA Implementation
- Programmable Auto-Sequencer
- Integrated Data Storage (up to 4 per channel) for Oversampling Applications
- 2-Bit Counter for Safety Applications
- Fully Specified Over the Extended Industrial Temperature Range: –40°C to +125°C

2 Applications

- Motor Control: Current and Position Measurement including Safety Applications
- Power Quality Measurement
- Three-Phase Power Control
- Programmable Logic Controllers
- Industrial Automation
- Protection Relays

3 Description

The ADS8363 is a dual, 16-bit, 1-MSPS analog-to-digital converter (ADC) with eight pseudo- or four fully-differential input channels grouped into two pairs for simultaneous signal acquisition. The analog inputs are maintained differentially to the input of the ADC. The input multiplexer can be used in either pseudo-differential mode, supporting up to four channels per ADC (4x2), or in fully-differential mode that allows to convert up to two inputs per ADC (2x2). The ADS7263 is a 14-bit version and the ADS7223 is a 12-bit version of the ADS8363.

The ADS8363, ADS7263, and ADS7223 offer two programmable reference outputs, flexible supply voltage ranges, a programmable auto-sequencer, data storage of up to four conversion results per channel, and several power-down features.

All devices are offered in a 5-mm x 5-mm, 32-pin VQFN package.

Device Information⁽¹⁾

PART NUMBER	PACKAGE	BODY SIZE (NOM)
ADSxxx3	VQFN (32)	5.00 mm x 5.00 mm

(1) For all available packages, see the package option addendum at the end of the data sheet.

Functional Block Diagram

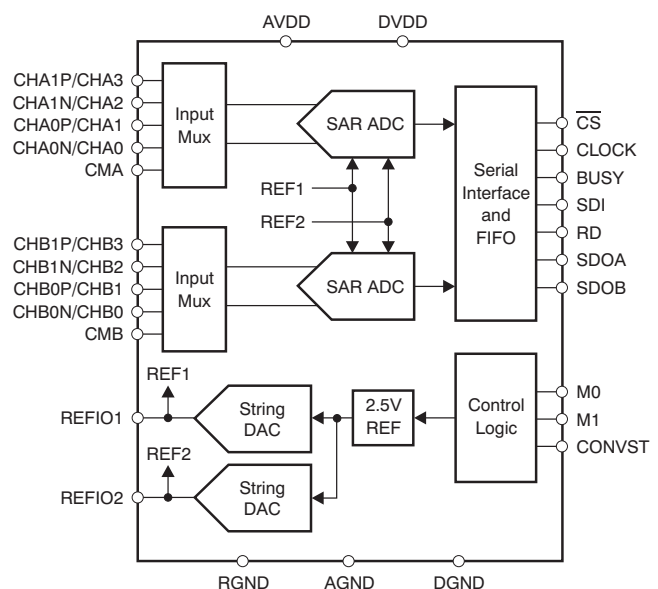

Table of Contents

1 Features	1	8.3 Feature Description.....	19
2 Applications	1	8.4 Device Functional Modes.....	24
3 Description	1	8.5 Programming.....	26
4 Revision History	2	8.6 Register Maps	34
5 Device Comparison Table	4	9 Application and Implementation	42
6 Pin Configuration and Functions	4	9.1 Application Information.....	42
7 Specifications	6	10 Power Supply Recommendations	45
7.1 Absolute Maximum Ratings	6	11 Layout	46
7.2 ESD Ratings.....	6	11.1 Layout Guidelines	46
7.3 Recommended Operating Conditions.....	6	11.2 Layout Example	47
7.4 Thermal Information	6	12 Device and Documentation Support	48
7.5 Electrical Characteristics: General.....	7	12.1 Documentation Support	48
7.6 Electrical Characteristics: ADS8363	9	12.2 Related Links	48
7.7 Electrical Characteristics: ADS7263	9	12.3 Receiving Notification of Documentation Updates	48
7.8 Electrical Characteristics: ADS7223	10	12.4 Community Resources.....	48
7.9 Switching Characteristics	11	12.5 Trademarks	48
7.10 Typical Characteristics	14	12.6 Electrostatic Discharge Caution.....	48
8 Detailed Description	18	12.7 Glossary	48
8.1 Overview	18	13 Mechanical, Packaging, and Orderable	
8.2 Functional Block Diagram	18	Information	49

4 Revision History

Changes from Revision C (January 2017) to Revision D	Page
• Changed operating temperature from 85°C to 125°C in <i>Recommended Operating Conditions</i> table	6

Changes from Revision B (January 2011) to Revision C	Page
• Added <i>Device Information</i> table, <i>ESD Ratings</i> table, <i>Recommended Operating Conditions</i> table, <i>Feature Description</i> section, <i>Device Functional Modes</i> section, <i>Application and Implementation</i> section, <i>Power Supply Recommendations</i> section, <i>Layout</i> section, <i>Device and Documentation Support</i> section, and <i>Mechanical, Packaging, and Orderable Information</i> section	1
• Changed ADS8363/7263/7223 to ADS8363, ADS7263, and ADS7223 throughout document	1
• Changed Description section: changed last sentence of first paragraph and last paragraph	1
• Changed <i>Device Comparison Table</i> title	4
• Changed <i>Pin Configuration and Functions</i> section title.....	4
• Changed footnote of Figure 1 and for clarity	12
• Changed second and third columns of <i>Midscale – 1 LSB</i> row in <i>Output Data Format</i> table: changed $-V_{REF}$ to $-2V_{REF}$ in column 2, changed last two voltage values in column 3	26
• Changed footnote of Figure 31	27
• Changed footnote of Figure 32	28
• Changed footnote of Figure 33	29
• Changed footnote of Figure 34	30
• Changed footnote of Figure 35	31
• Changed footnote of Figure 36	32
• Changed footnote of Figure 38	34
• Changed footnote of Figure 40	36
• Changed 1FFh to 3FFh in bits 9-0 description of <i>REFDAC1 Control Register</i> and <i>REFDAC2 Control Register</i>	37

Changes from Revision A (December, 2010) to Revision B	Page
• Revised test conditions for gain error parameter	9
• Revised test conditions for gain error parameter	9
• Revised test conditions for gain error parameter	10
• Updated CONVST high time specification.....	11
• Revised CONVST section	20
• Revised Mode II section	28
• Revised Special Read Mode II section.....	29
• Revised Fully-Differential Mode IV section.....	31
• Revised Special Mode IV section.....	32
• Added CONVST section in <i>ADS8361 Compatibility</i>	43

Changes from Original (October, 2010) to Revision A	Page
• Added RD high time (t_3) parameter to Timing Characteristics table	11
• Updated Figure 1	12
• Revised RD section in <i>ADS8361 Compatibility</i>	43
• Added t_3 timing trace to Figure 48	45
• Deleted <i>Four-Wire Application Timing Requirements</i> table	45

5 Device Comparison Table

PRODUCT	RESOLUTION	NMC	INL	SNR	THD
ADS8363	16 bits	16 or 15 bits ⁽¹⁾	±3 or ±4 LSB ⁽¹⁾	93 dB (typ)	-98 dB (typ)
ADS7263	14 bits	14 bits	±1 LSB	85 dB (typ)	-92 dB (typ)
ADS7223	12 bits	12 bits	±0.5 LSB	73 dB (typ)	-86 dB (typ)

(1) See the [Electrical Characteristics](#) table.

6 Pin Configuration and Functions

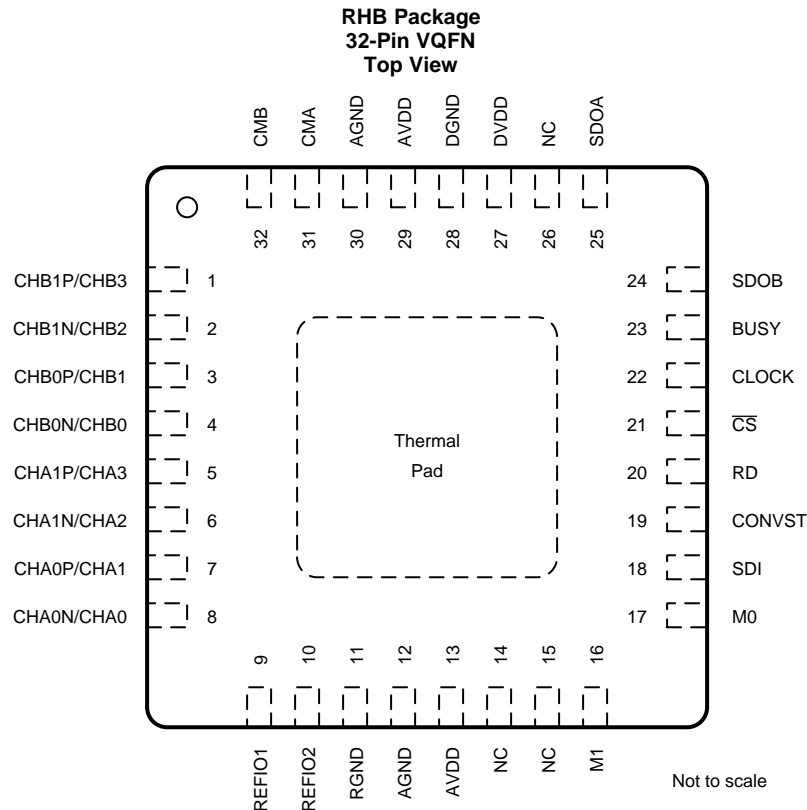

Pin Functions

PIN		TYPE ⁽¹⁾	DESCRIPTION
NAME	NO.		
AGND	12, 30	P	Analog ground. Connect to analog ground plane.
AVDD	13, 29	P	Analog power supply, 2.7 V to 5.5 V. Decouple to AGND with a 1-μF ceramic capacitor.
BUSY	23	DO	Converter busy indicator. BUSY goes high when the inputs are in hold mode and returns to low after the conversion is complete.
CHA0N/CHA0	8	AI	Fully-differential inverting analog input channel A1 or pseudo-differential input A0
CHA0P/CHA1	7	AI	Fully-differential noninverting analog input channel A1 or pseudo-differential input A1
CHA1N/CHA2	6	AI	Fully-differential inverting analog input channel A1 or pseudo-differential input A2
CHA1P/CHA3	5	AI	Fully-differential noninverting analog input channel A1 or pseudo-differential input A3
CHB0N/CHB0	4	AI	Fully-differential inverting analog input channel B0 or pseudo-differential input B0
CHB0P/CHB1	3	AI	Fully-differential noninverting analog input channel B0 or pseudo-differential input B1
CHB1N/CHB2	2	AI	Fully-differential inverting analog input channel B1 or pseudo-differential input B2
CHB1P/CHB3	1	AI	Fully-differential noninverting analog input channel B1 or pseudo-differential input B3

(1) AI = analog input, AIO = analog input/output, DI = digital input, DO = digital output, DIO = digital input/output, P = power supply, NC = not connected.

Pin Functions (continued)

PIN		TYPE ⁽¹⁾	DESCRIPTION
NAME	NO.		
CLOCK	22	DI	External clock input. The range is 0.5 MHz to 20 MHz in half-clock mode, or 1 MHz to 40 MHz in full-clock mode.
CMA	31	AI	Common-mode voltage input for channels Ax (in pseudo-differential mode only).
CMB	32	AI	Common-mode voltage input for channels Bx (in pseudo-differential mode only).
CONVST	19	DI	Conversion start. The ADC switches from sample into hold mode on the rising edge of CONVST. Thereafter, the conversion starts with the next rising edge of the CLOCK pin.
$\overline{\text{CS}}$	21	DI	Chip select. When this pin is low, the SDOx, SDI, and RD pins are active; when this pin is high, the SDOx outputs are 3-stated, and the SDI and RD inputs are ignored.
DGND	28	P	Digital ground. Connect to digital ground plane.
DVDD	27	P	Digital supply, 2.3 V to 5.5 V. Decouple to DGND with a 1- μ F ceramic capacitor.
M0	17	DI	Mode pin 0. Selects analog input channel mode (see Table 5).
M1	16	DI	Mode pin 1. Selects the digital output mode (see Table 5).
NC	14, 15, 26	NC	This pin is not internally connected.
RD	20	DI	Read data. Synchronization pulse for the SDOx outputs and SDI input. RD only triggers when $\overline{\text{CS}}$ is low.
REFIO1	9	AIO	Reference voltage input/output 1. A ceramic capacitor of 22 μ F connected to RGND is required.
REFIO2	10	AIO	Reference voltage input/output 2. A ceramic capacitor of 22 μ F connected to RGND is required.
RGND	11	P	Reference ground. Connect to analog ground plane with a dedicated via.
SDI	18	DI	Serial data input. This pin is used to set up of the internal registers, and can also be used in ADS8361-compatible manner. The data on SDI are ignored when $\overline{\text{CS}}$ is high.
SDOA	25	DO	Serial data output for converter A. 3-state when $\overline{\text{CS}}$ is high.
SDOB	24	DO	Serial data output for converter B. Active only if M1 is low. 3-state when $\overline{\text{CS}}$ is high.

7 Specifications

7.1 Absolute Maximum Ratings

 over operating free-air temperature range (unless otherwise noted)⁽¹⁾

	MIN	MAX	UNIT
Supply voltage, AVDD to AGND or DVDD to DGND	-0.3	6	V
Supply voltage, DVDD to AVDD		1.2 × AVDD ⁽²⁾	V
Analog and reference input voltage with respect to AGND	AGND - 0.3	AVDD + 0.3	V
Digital input voltage with respect to DGND	DGND - 0.3	DVDD + 0.3	V
Ground voltage difference AGND-DGND		0.3	V
Input current to any pin except supply pins	-10	10	mA
Maximum virtual junction temperature, T _J		150	°C
Storage temperature, T _{stg}	-65	150	°C

- (1) Stresses beyond those listed under *Absolute Maximum Ratings* may cause permanent damage to the device. These are stress ratings only, which do not imply functional operation of the device at these or any other conditions beyond those indicated under *Recommended Operating Conditions*. Exposure to absolute-maximum-rated conditions for extended periods may affect device reliability.
- (2) Exceeding the specified limit causes an increase of the DVDD leakage current and leads to malfunction of the device.

7.2 ESD Ratings

		VALUE	UNIT
V _(ESD)	Electrostatic discharge	Human-body model (HBM), per ANSI/ESDA/JEDEC JS-001 ⁽¹⁾	±2000
		Charged-device model (CDM), per JEDEC specification JESD22-C101 ⁽²⁾	±500
			V

- (1) JEDEC document JEP155 states that 500-V HBM allows safe manufacturing with a standard ESD control process.
- (2) JEDEC document JEP157 states that 250-V CDM allows safe manufacturing with a standard ESD control process.

7.3 Recommended Operating Conditions

over operating free-air temperature range (unless otherwise noted)

		MIN	NOM	MAX	UNIT
AVDD	Analog supply voltage		5		V
DVDD	Digital supply voltage		3.3		V
	Operating temperature	-40		125	°C

7.4 Thermal Information

THERMAL METRIC ⁽¹⁾		ADS8363, ADS7263, ADS7223		UNIT
		RHB (VQFN)		
		32 PINS		
R _{θJA}	Junction-to-ambient thermal resistance	33.3		°C/W
R _{θJC(top)}	Junction-to-case (top) thermal resistance	29.5		°C/W
R _{θJB}	Junction-to-board thermal resistance	7.3		°C/W
ψ _{JT}	Junction-to-top characterization parameter	0.2		°C/W
ψ _{JB}	Junction-to-board characterization parameter	7.4		°C/W
R _{θJC(bot)}	Junction-to-case (bottom) thermal resistance	0.9		°C/W

- (1) For more information about traditional and new thermal metrics, see the [Semiconductor and IC Package Thermal Metrics](#) application report.

7.5 Electrical Characteristics: General

All minimum and maximum specifications at $T_A = -40^{\circ}\text{C}$ to $+125^{\circ}\text{C}$, specified supply voltage range, $V_{REF} = 2.5\text{ V}$ (int), and $t_{DATA} = 1\text{ MSPS}$ (unless otherwise noted). Typical values are at $T_A = +25^{\circ}\text{C}$, $AVDD = 5\text{ V}$, and $DVDD = 3.3\text{ V}$.

PARAMETER		TEST CONDITIONS	MIN	TYP	MAX	UNIT
ANALOG INPUT						
FSR	Full-scale input range	(CHxxP – CHxxN) or CHxx to CMx	$-V_{REF}$		$+V_{REF}$	V
V_{IN}	Absolute input voltage	CHxx to AGND	-0.1		$AVDD + 0.1$	V
C_{IN}	Input capacitance	CHxx to AGND		45		pF
C_{ID}	Differential input capacitance			22.5		pF
I_{IL}	Input leakage current		-16		16	nA
PSRR	Power-supply rejection ratio	$AVDD = 5.5\text{ V}$		75		dB
SAMPLING DYNAMICS						
t_{CONV}	Conversion time per ADC	Half-clock mode	17.5			t_{CLK}
		Full-clock mode	35			
t_{ACQ}	Acquisition time	Half-clock mode	2			t_{CLK}
		Full-clock Mode	4			
f_{DATA}	Data rate		25		1000	kSPS
t_A	Aperture delay				6	ns
	t_A match	ADC to ADC		50		ps
t_{AJIT}	Aperture jitter			50		ps
f_{CLK}	Clock frequency	Half-clock mode	0.5		20	MHz
		Full-clock mode	1		40	
t_{CLK}	Clock period	Half-clock mode	50		2000	ns
		Full-clock mode	25		1000	
INTERNAL VOLTAGE REFERENCE						
Resolution	Reference output DAC resolution		10			Bits
V_{REFOUT}	Reference output voltage	Over 20% to 100% DAC range	$0.2V_{REFOUT}$		V_{REFOUT}	V
		REFIO1, DAC = 3FFh	2.485	2.500	2.515	
		REFIO2, DAC = 3FFh	2.480	2.500	2.520	
dV_{REFOUT}/dT	Reference voltage drift			± 10		ppm/ $^{\circ}\text{C}$
DNL_{DAC}	DAC differential linearity error		-4	± 1	4	LSB
INL_{DAC}	DAC integral linearity error		-4	± 0.5	4	LSB
V_{OSDAC}	DAC offset error	$V_{REFOUT} = 0.5\text{ V}$	-4	± 1	4	LSB
PSRR	Power-supply rejection ratio			73		dB
I_{REFOUT}	Reference output dc current		-2		+2	mA
I_{REFSC}	Reference output short-circuit current ⁽¹⁾			50		mA
t_{REFON}	Reference output settling time	$C_{REF} = 22\ \mu\text{F}$		8		ms
VOLTAGE REFERENCE INPUT						
V_{REF}	Reference input voltage range		0.5	2.5	2.525	V
I_{REF}	Reference input current			50		μA
C_{REF}	External ceramic reference capacitance			22		μF

(1) Reference output current is not internally limited.

Electrical Characteristics: General (continued)

All minimum and maximum specifications at $T_A = -40^\circ\text{C}$ to $+125^\circ\text{C}$, specified supply voltage range, $V_{REF} = 2.5\text{ V}$ (int), and $t_{DATA} = 1\text{ MSPS}$ (unless otherwise noted). Typical values are at $T_A = +25^\circ\text{C}$, $AVDD = 5\text{ V}$, and $DVDD = 3.3\text{ V}$.

PARAMETER		TEST CONDITIONS	MIN	TYP	MAX	UNIT
DIGITAL INPUTS⁽²⁾						
I_{IN}	Input current	$V_{IN} = DVDD$ to DGND	-50		+50	nA
C_{IN}	Input capacitance			5		pF
	Logic family		CMOS with Schmitt-Trigger			
V_{IH}	High-level input voltage	$DVDD = 4.5\text{ V}$ to 5.5 V	$0.7DVDD$		$DVDD + 0.3$	V
V_{IL}	Low-level input voltage	$DVDD = 4.5\text{ V}$ to 5.5 V	-0.3		$0.3DVDD$	V
	Logic family		LVCMOS			
V_{IH}	High-level input voltage	$DVDD = 2.3\text{ V}$ to 3.6 V	2		$DVDD + 0.3$	V
V_{IL}	Low-level input voltage	$DVDD = 2.3\text{ V}$ to 3.6 V	-0.3		0.8	V
DIGITAL OUTPUTS⁽²⁾						
C_{OUT}	Output capacitance			5		pF
C_{LOAD}	Load capacitance				30	pF
	Logic family		CMOS			
V_{OH}	High-level output voltage	$DVDD = 4.5\text{ V}$, $I_{OH} = -100\ \mu\text{A}$	4.44			V
V_{OL}	Low-level output voltage	$DVDD = 4.5\text{ V}$, $I_{OH} = +100\ \mu\text{A}$			0.5	V
	Logic family		LVCMOS			
V_{OH}	High-level output voltage	$DVDD = 2.3\text{ V}$, $I_{OH} = -100\ \mu\text{A}$	$DVDD - 0.2$			V
V_{OL}	Low-level output voltage	$DVDD = 2.3\text{ V}$, $I_{OH} = +100\ \mu\text{A}$			0.2	V
POWER SUPPLY						
AVDD	Analog supply voltage	AVDD to AGND, half-clock mode	2.7	5.0	5.5	V
		AVDD to AGND, full-clock mode	4.5	5.0	5.5	
DVDD	Digital supply voltage	3-V and 3.3-V levels	2.3	2.5	3.6	V
		5-V levels, half-clock mode only	4.5	5.0	5.5	
AIDD	Analog supply current	AVDD = 3.6 V		12.0	16.0	mA
		AVDD = 5.5 V		15.0	20.0	
		AVDD = 3.6 V, sleep and auto-sleep modes		0.8	1.2	
		AVDD = 5.5 V, sleep and auto-sleep modes		0.9	1.4	
		Power-down mode			0.005	
DIDD	Digital supply current	$DVDD = 3.6\text{ V}$, $C_{LOAD} = 10\text{ pF}$		1.1	2.5	mA
		$DVDD = 5.5\text{ V}$, $C_{LOAD} = 10\text{ pF}$		3	6	
P_D	Power dissipation (normal operation)	AVDD = DVDD = 3.6 V		47.2	66.6	mW
		AVDD = 5.5 V, DVDD = 3.6 V		86.5	117.0	

(2) Specified by design; not production tested.

7.6 Electrical Characteristics: ADS8363

All minimum and maximum specifications at $T_A = -40^\circ\text{C}$ to $+125^\circ\text{C}$, specified supply voltage range, $V_{REF} = 2.5\text{ V}$ (int), and $t_{DATA} = 1\text{ MSPS}$ (unless otherwise noted). Typical values are at $T_A = +25^\circ\text{C}$, $AVDD = 5\text{ V}$, and $DVDD = 3.3\text{ V}$.

PARAMETER		TEST CONDITIONS	MIN	TYP	MAX	UNIT
RESOLUTION						
Resolution			16			Bits
DC ACCURACY						
INL	Integral nonlinearity	Half-clock mode	-3	± 1.2	+3	LSB
		Full-clock mode	-4	± 1.5	+4	
DNL	Differential nonlinearity	Half-clock mode	-0.99	± 0.6	+2	LSB
		Full-clock mode	-1.5	± 0.8	+3	
V_{OS}	Input offset error		-2	± 0.2	+2	mV
	V_{OS} match	ADC to ADC	-1	± 0.1	+1	mV
dV_{OS}/dT	Input offset thermal drift			1		$\mu\text{V}/^\circ\text{C}$
G_{ERR}	Gain error	Referenced to the voltage at REFIOx	-0.1%	$\pm 0.01\%$	+0.1%	
		G_{ERR} match	ADC to ADC	-0.1%	$\pm 0.005\%$	+0.1%
G_{ERR}/dT	Gain error thermal drift	Referenced to the voltage at REFIOx		1		ppm/ $^\circ\text{C}$
CMRR	Common-mode rejection ratio	Both ADCs, dc to 100 kHz		92		dB
AC ACCURACY						
SINAD	Signal-to-noise + distortion	$V_{IN} = 5\text{ V}_{PP}$ at 10 kHz	89	92		dB
SNR	Signal-to-noise ratio	$V_{IN} = 5\text{ V}_{PP}$ at 10 kHz	90	93		dB
THD	Total harmonic distortion	$V_{IN} = 5\text{ V}_{PP}$ at 10 kHz		-98	-90	dB
SFDR	Spurious-free dynamic range	$V_{IN} = 5\text{ V}_{PP}$ at 10 kHz	90	100		dB

7.7 Electrical Characteristics: ADS7263

All minimum and maximum specifications at $T_A = -40^\circ\text{C}$ to $+125^\circ\text{C}$, specified supply voltage range, $V_{REF} = 2.5\text{ V}$ (int), and $t_{DATA} = 1\text{ MSPS}$ (unless otherwise noted). Typical values are at $T_A = +25^\circ\text{C}$, $AVDD = 5\text{ V}$, and $DVDD = 3.3\text{ V}$.

PARAMETER		TEST CONDITIONS	MIN	TYP	MAX	UNIT
RESOLUTION						
Resolution			14			Bits
DC ACCURACY						
INL	Integral nonlinearity		-1	± 0.4	+1	LSB
DNL	Differential nonlinearity		-0.5	± 0.2	+1	LSB
V_{OS}	Input offset error		-2	± 0.2	+2	mV
	V_{OS} match	ADC to ADC	-1	± 0.1	+1	mV
dV_{OS}/dT	Input offset thermal drift			1		$\mu\text{V}/^\circ\text{C}$
G_{ERR}	Gain error	Referenced to the voltage at REFIOx	-0.1%	$\pm 0.01\%$	+0.1%	
		G_{ERR} match	ADC to ADC	-0.1%	$\pm 0.005\%$	+0.1%
G_{ERR}/dT	Gain error thermal drift	Referenced to the voltage at REFIOx		1		ppm/ $^\circ\text{C}$
CMRR	Common-mode rejection ratio	Both ADCs, dc to 100 kHz		92		dB
AC ACCURACY						
SINAD	Signal-to-noise + distortion	$V_{IN} = 5\text{ V}_{PP}$ at 10 kHz	82	84		dB
SNR	Signal-to-noise ratio	$V_{IN} = 5\text{ V}_{PP}$ at 10 kHz	84	85		dB
THD	Total harmonic distortion	$V_{IN} = 5\text{ V}_{PP}$ at 10 kHz		-92	-88	dB
SFDR	Spurious-free dynamic range	$V_{IN} = 5\text{ V}_{PP}$ at 10 kHz	88	92		dB

7.8 Electrical Characteristics: ADS7223

All minimum and maximum specifications at $T_A = -40^{\circ}\text{C}$ to $+125^{\circ}\text{C}$, specified supply voltage range, $V_{REF} = 2.5\text{ V}$ (int), and $t_{DATA} = 1\text{ MSPS}$ (unless otherwise noted). Typical values are at $T_A = +25^{\circ}\text{C}$, $AVDD = 5\text{ V}$, and $DVDD = 3.3\text{ V}$.

PARAMETER		TEST CONDITIONS	MIN	TYP	MAX	UNIT
RESOLUTION						
Resolution			12			Bits
DC ACCURACY						
INL	Integral nonlinearity		-0.5	± 0.2	+0.5	LSB
DNL	Differential nonlinearity		-0.5	± 0.1	+0.5	LSB
V_{OS}	Input offset error		-2	± 0.2	+2	mV
	V_{OS} match	ADC to ADC	-1	± 0.1	+1	mV
dV_{OS}/dT	Input offset thermal drift			1		$\mu\text{V}/^{\circ}\text{C}$
G_{ERR}	Gain error	Referenced to the voltage at REFIOx	-0.1%	$\pm 0.01\%$	+0.1%	
	G_{ERR} match	ADC to ADC	-0.1%	$\pm 0.005\%$	+0.1%	
G_{ERR}/dT	Gain error thermal drift	Referenced to the voltage at REFIOx		1		ppm/ $^{\circ}\text{C}$
CMRR	Common-mode rejection ratio	Both ADCs, dc to 100 kHz		92		dB
AC ACCURACY						
SINAD	Signal-to-noise + distortion	$V_{IN} = 5 V_{PP}$ at 10 kHz	71	72		dB
SNR	Signal-to-noise ratio	$V_{IN} = 5 V_{PP}$ at 10 kHz	72	73		dB
THD	Total harmonic distortion	$V_{IN} = 5 V_{PP}$ at 10 kHz		-86	-84	dB
SFDR	Spurious-free dynamic range	$V_{IN} = 5 V_{PP}$ at 10 kHz	84	86		dB

7.9 Switching Characteristics⁽¹⁾

Over the recommended operating free-air temperature range of -40°C to $+125^{\circ}\text{C}$, and $\text{DVDD} = 2.3\text{ V}$ to 5.5 V (unless otherwise noted).

		MIN	MAX	UNIT	
t_{DATA}	Data throughput, $f_{\text{CLK}} = \text{max}$	1		μs	
t_{CONV}	Conversion time	Half-clock mode	17.5	t_{CLK}	
		Full-clock mode	35		
t_{ACQ}	Acquisition time	100		ns	
f_{CLK}	CLOCK frequency	Half-clock mode	0.5	20	MHz
		Full-clock mode	1	40	
t_{CLK}	CLOCK period	Half-clock mode	50	2000	ns
		Full-clock mode	25	1000	
t_{CLKL}	CLOCK low time	11.25		ns	
t_{CLKH}	CLOCK high time	11.25		ns	
t_1	CONVST rising edge to first CLOCK rising edge	12		ns	
t_2	CONVST high time		10	ns	
		Half-clock mode: timing modes II and IV only		1	t_{CLK}
t_3	RD high time, half-clock mode: timing modes II, IV, SII, and SIV only		1	t_{CLK}	
t_{S1}	RD high to CLOCK falling edge setup time	5		ns	
t_{H1}	RD high to CLOCK falling edge hold time	5		ns	
t_{S2}	Input data to CLOCK falling edge setup time	5		ns	
t_{H2}	Input data to CLOCK falling edge hold time	4		ns	
t_{D1}	CONVST rising edge to BUSY high delay ⁽²⁾	$2.3\text{ V} < \text{DVDD} < 3.6\text{ V}$		19	ns
		$4.5\text{ V} < \text{DVDD} < 5.5\text{ V}$		16	
t_{D2}	CLOCK 18th falling edge (half-clock mode) or 24th rising edge (full-clock mode) to BUSY low delay	$2.3\text{ V} < \text{DVDD} < 3.6\text{ V}$		25	ns
		$4.5\text{ V} < \text{DVDD} < 5.5\text{ V}$		20	
t_{D3}	CLOCK rising edge to next data valid delay	Half-clock mode, $2.3\text{ V} < \text{DVDD} < 3.6\text{ V}$		14	ns
		Half-clock mode, $4.5\text{ V} < \text{DVDD} < 5.5\text{ V}$		12	
t_{H3}	Output data to CLOCK rising edge hold time, half-clock mode	3		ns	
t_{D4}	CLOCK falling edge to next data valid delay, full-clock mode		19	ns	
t_{H4}	Output data to CLOCK falling edge hold time, full-clock mode	7		ns	
t_{D5}	RD falling edge to first data valid	$2.3\text{ V} < \text{DVDD} < 3.6\text{ V}$		16	ns
		$4.5\text{ V} < \text{DVDD} < 5.5\text{ V}$		12	
t_{D6}	$\overline{\text{CS}}$ rising edge to SDOx 3-state		6	ns	

(1) All input signals are specified with $t_{\text{R}} = t_{\text{F}} = 1.5\text{ ns}$ (10% to 90% of DVDD) and timed from a voltage level of $(V_{\text{IL}} + V_{\text{IH}}) / 2$.

(2) Not applicable in auto-sleep power-down mode.

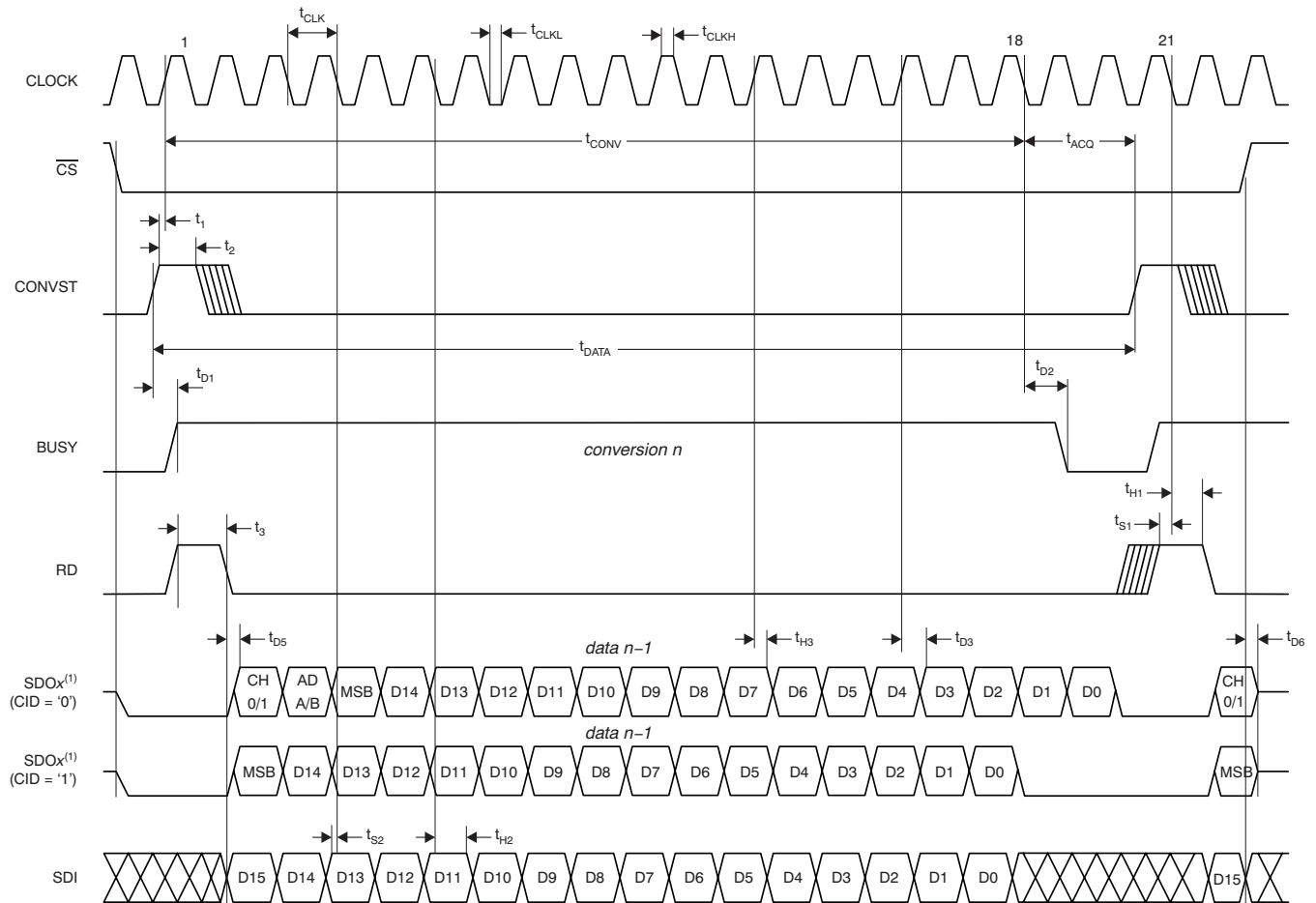

(1) The ADS7263 and ADS7223 output data with the MSB located as the ADS8363 and the last 2 or 4 bits are '0'.

Figure 1. Detailed Timing Diagram: Half-Clock Mode (ADS8361-Compatible)

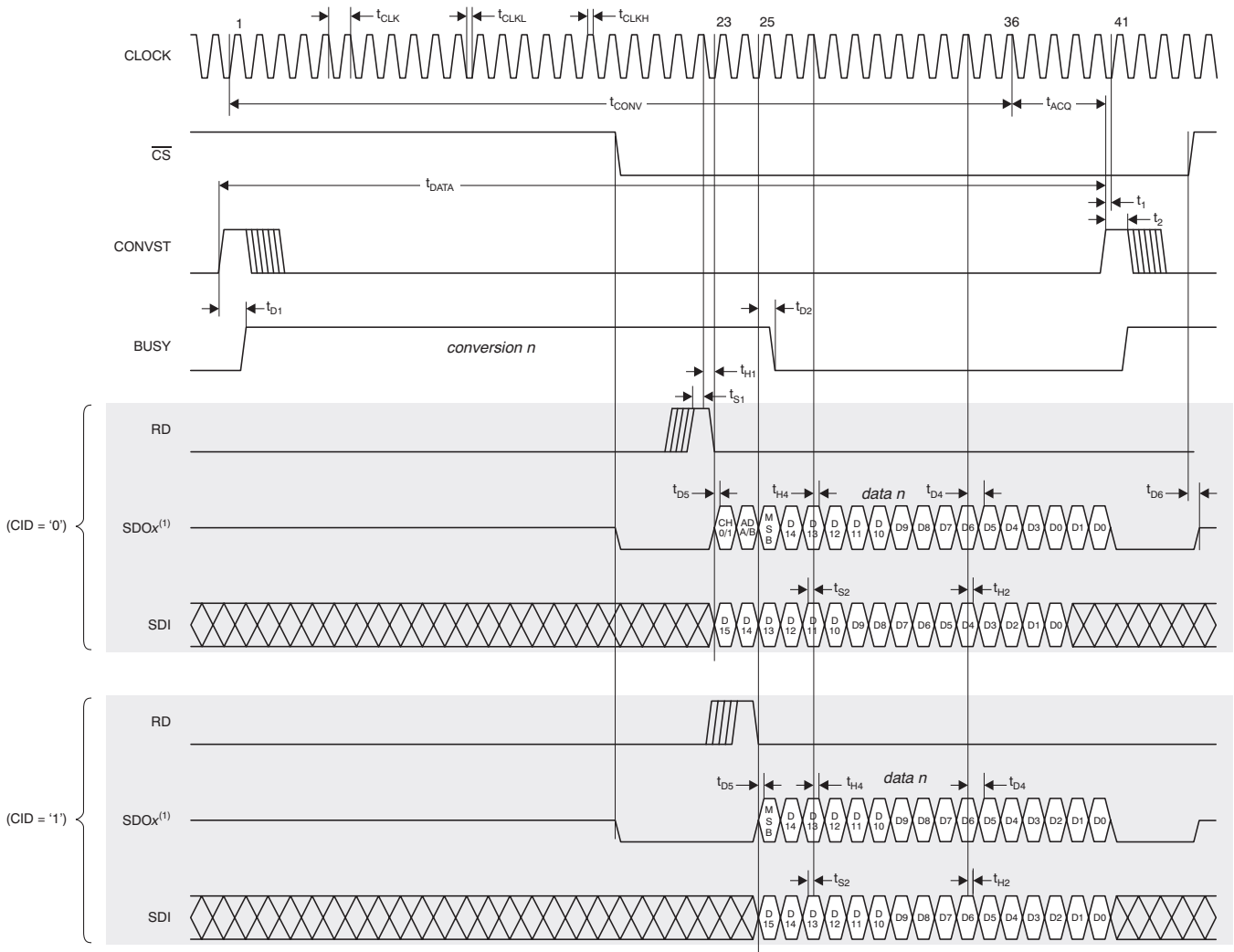

(2) The ADS7263 and ADS7223 output data with the MSB located as the ADS8363 and the last 2 or 4 bits are '0'.

Figure 2. Detailed Timing Diagram: Full-Clock Mode

7.10 Typical Characteristics

at $T_A = +25^\circ\text{C}$, $AVDD = 5\text{ V}$, $DVDD = 3.3\text{ V}$, $V_{REF} = 2.5\text{ V}$ (internal), and $f_{DATA} = 1\text{ MSPS}$ (unless otherwise noted)

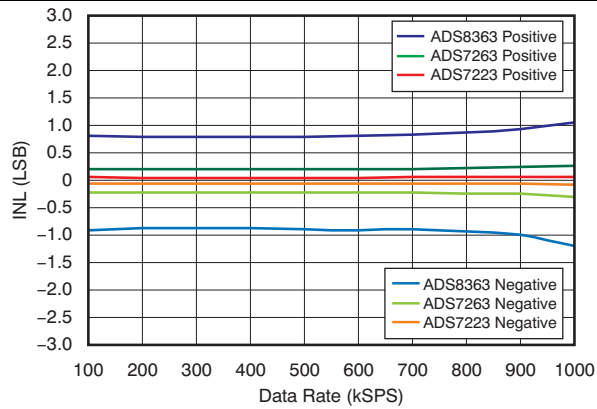

Figure 3. Integral Nonlinearity vs Data Rate

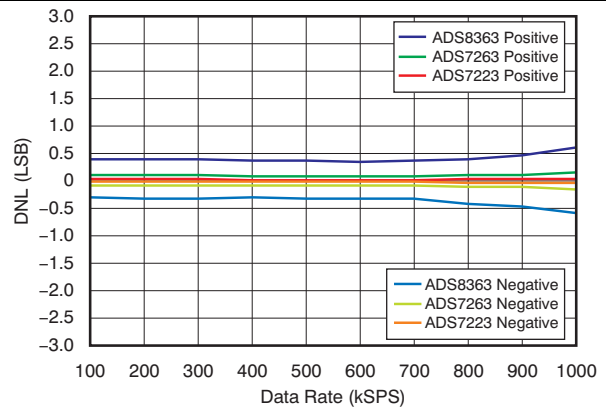

Figure 4. Differential Nonlinearity vs Data Rate

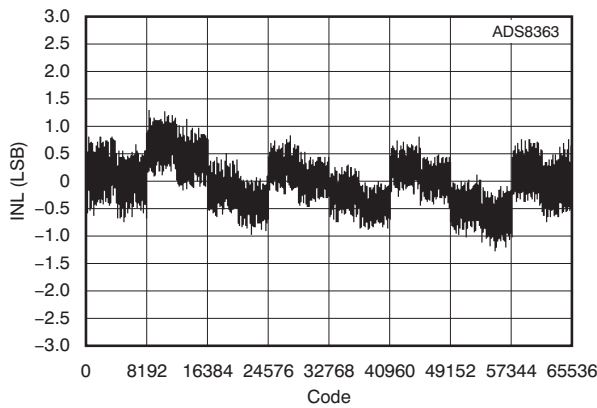

Figure 5. Integral Nonlinearity vs Code

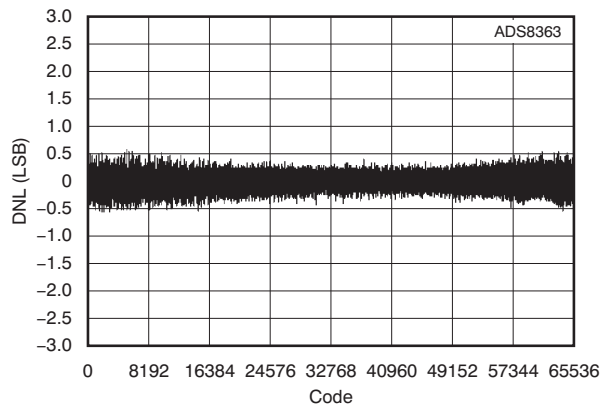

Figure 6. Differential Nonlinearity vs Code

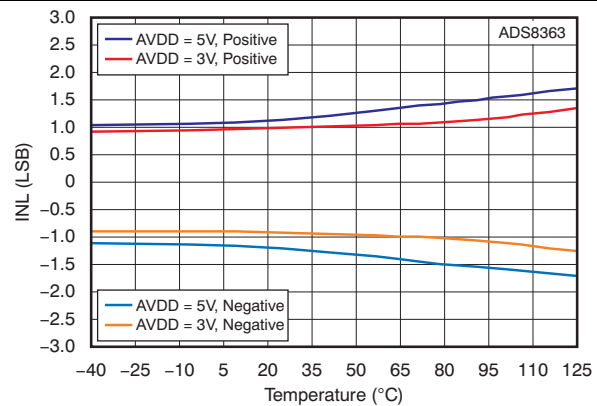

Figure 7. Integral Nonlinearity vs Temperature

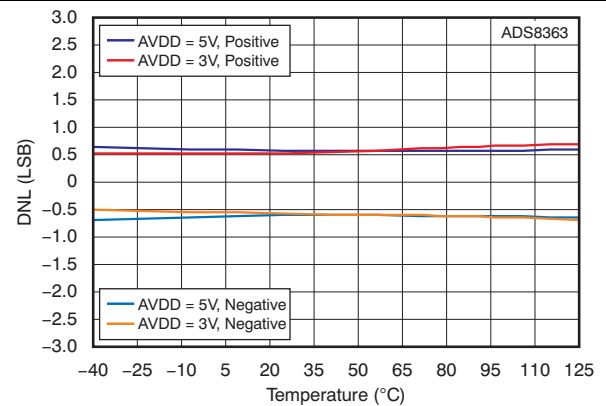

Figure 8. Differential Nonlinearity vs Temperature

Typical Characteristics (continued)

at $T_A = +25^\circ\text{C}$, $AVDD = 5\text{ V}$, $DVDD = 3.3\text{ V}$, $V_{REF} = 2.5\text{ V}$ (internal), and $f_{DATA} = 1\text{ MSPS}$ (unless otherwise noted)

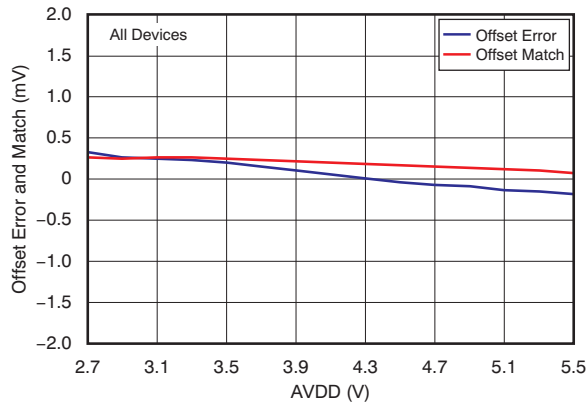

Figure 9. Offset Error and Offset Match vs Analog Supply Voltage

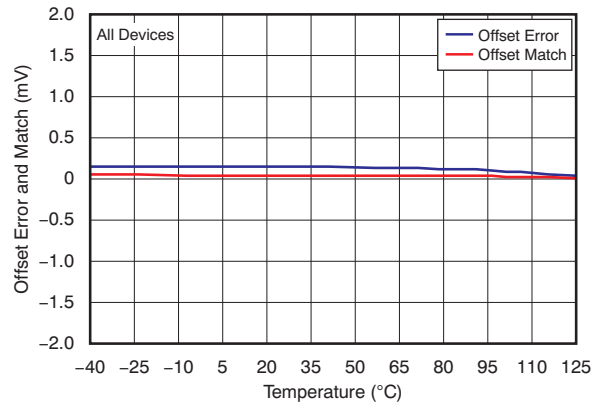

Figure 10. Offset Error and Offset Match vs Temperature

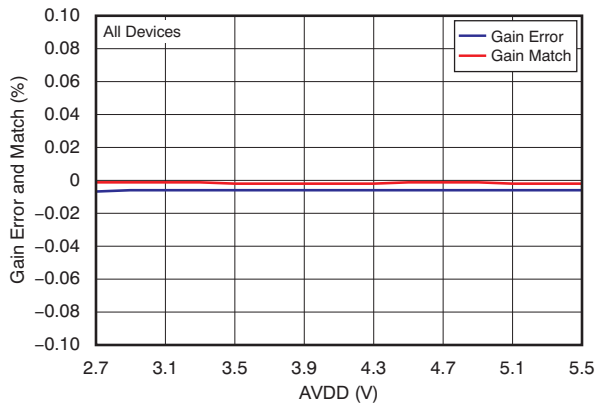

Figure 11. Gain Error and Gain Match vs Analog Supply Voltage

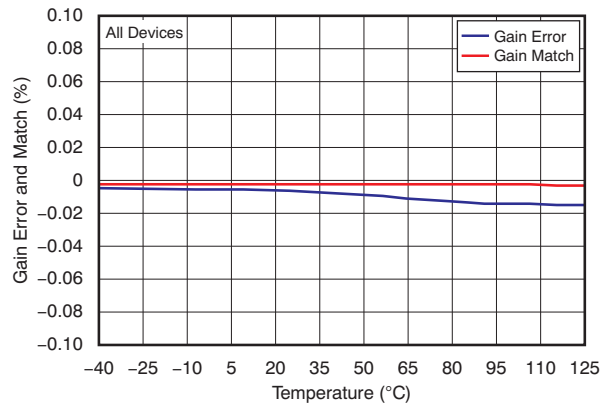

Figure 12. Gain Error and Gain Match vs Temperature

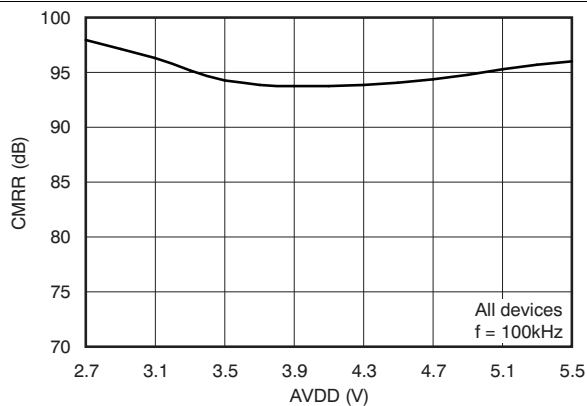

Figure 13. Common-Mode Rejection Ratio vs Analog Supply Voltage

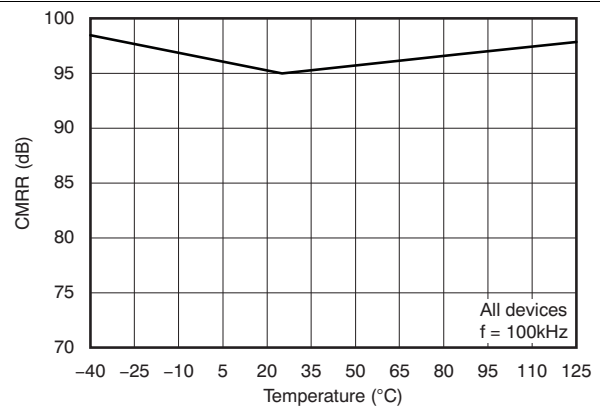

Figure 14. Common-Mode Rejection Ratio vs Temperature

Typical Characteristics (continued)

at $T_A = +25^\circ\text{C}$, $AV_{DD} = 5\text{ V}$, $DV_{DD} = 3.3\text{ V}$, $V_{REF} = 2.5\text{ V}$ (internal), and $f_{DATA} = 1\text{ MSPS}$ (unless otherwise noted)

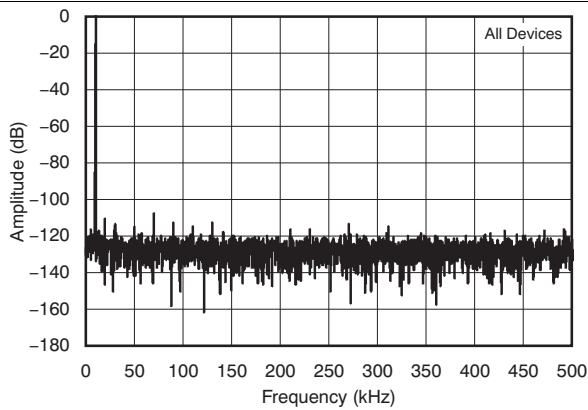

Figure 15. Frequency Spectrum (4096 Point FFT; $f_{IN} = 10\text{ kHz}$)

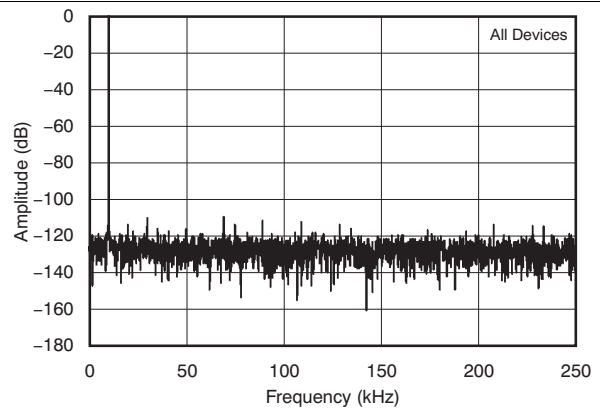

Figure 16. Frequency Spectrum (4096 Point FFT; $f_{IN} = 10\text{ kHz}$, $f_{SAMPLE} = 0.5\text{ MSPS}$)

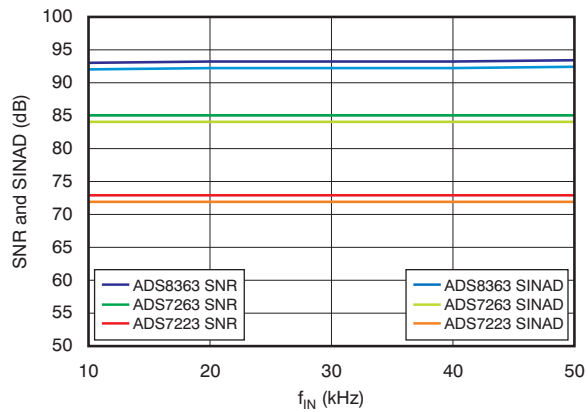

Figure 17. Signal-to-Noise Ratio and Signal-to-Noise + Distortion vs Input Signal Frequency

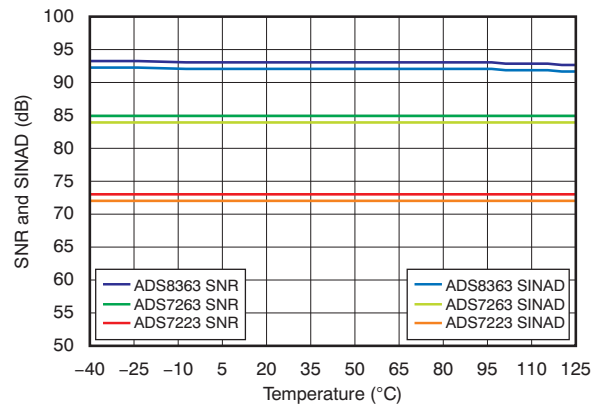

Figure 18. Signal-to-Noise Ratio and Signal-to-Noise + Distortion vs Temperature

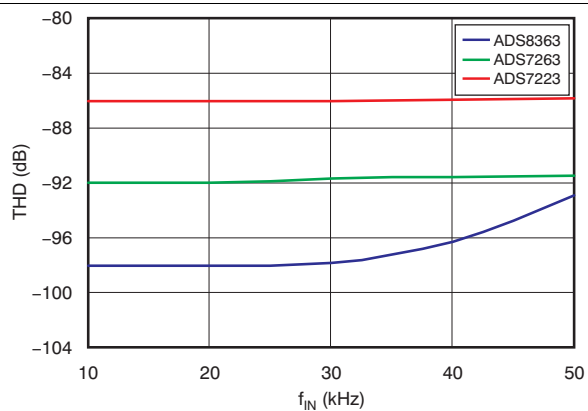

Figure 19. Total Harmonic Distortion vs Input Signal Frequency

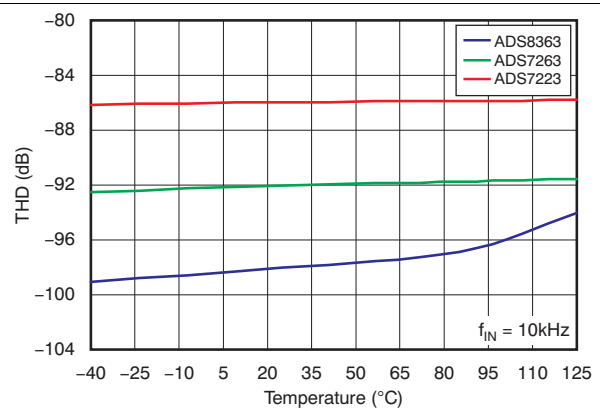

Figure 20. Total Harmonic Distortion vs Temperature

Typical Characteristics (continued)

at $T_A = +25^\circ\text{C}$, $AVDD = 5\text{ V}$, $DVDD = 3.3\text{ V}$, $V_{REF} = 2.5\text{ V}$ (internal), and $f_{DATA} = 1\text{ MSPS}$ (unless otherwise noted)

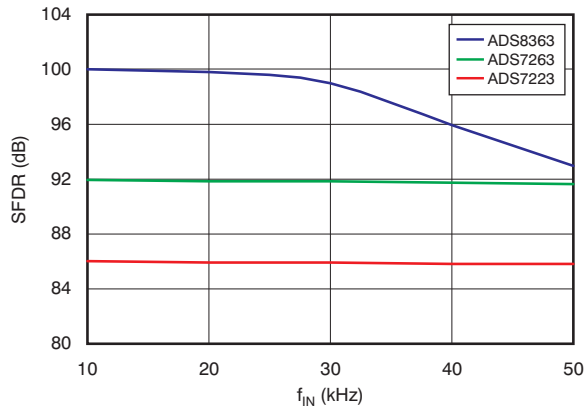

Figure 21. Spurious-Free Dynamic Range vs Input Signal Frequency

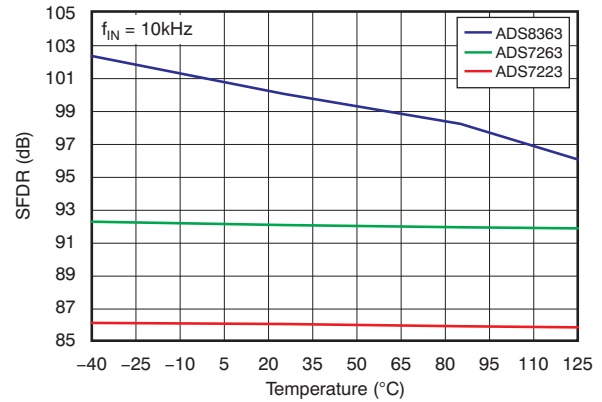

Figure 22. Spurious-Free Dynamic Range vs Temperature

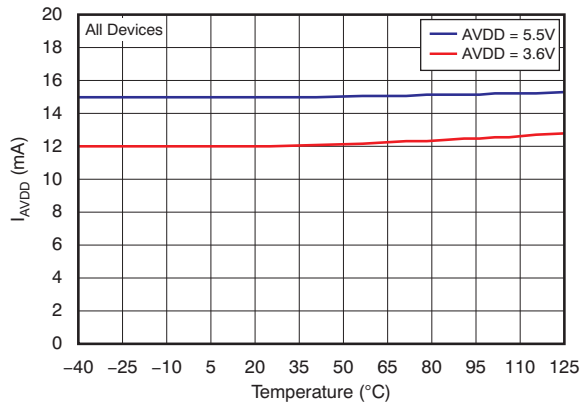

Figure 23. Analog Supply Current vs Temperature

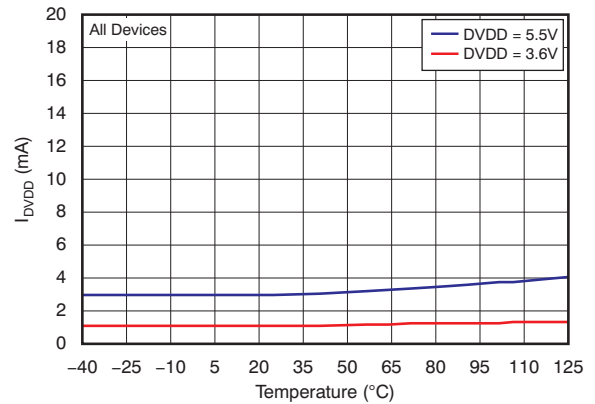

Figure 24. Digital Supply Current vs Temperature

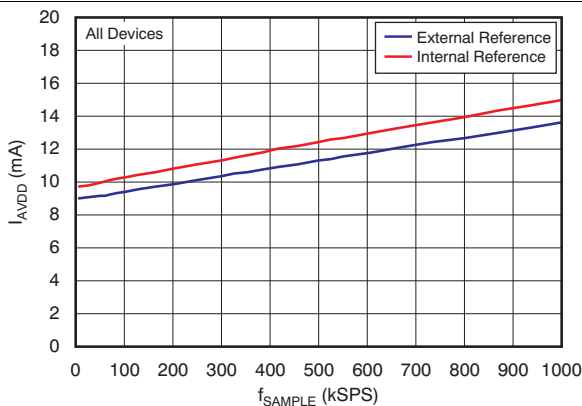

Figure 25. Analog Supply Current vs Data Rate

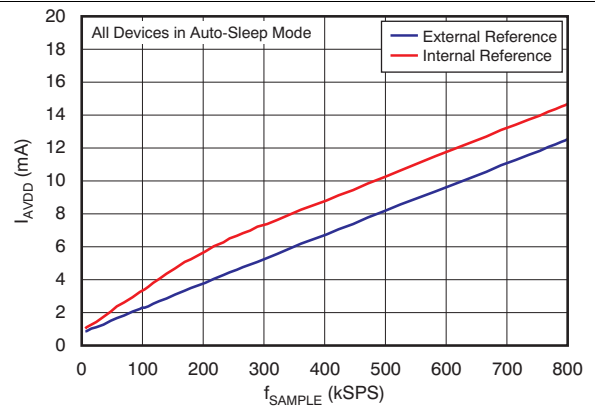

Figure 26. Analog Supply Current vs Data Rate (Auto-Sleep Mode)

8 Detailed Description

8.1 Overview

The ADS8363, ADS7263, and ADS7223 contain two 16-, 14-, and 12-bit analog-to-digital converters (ADCs), respectively, that operate based on the successive approximation register (SAR) principle. These ADCs sample and convert simultaneously. Conversion time can be as low as 875 ns. Adding an acquisition time of 100 ns, and a margin of 25 ns for propagation delay and CONVST pulse generation, results in a maximum conversion rate of 1 MSPS.

Each ADC has a fully-differential 2:1 multiplexer front-end. In many common applications, all negative input signals remain at the same constant voltage (for example, 2.5 V). For these applications, the multiplexer can be used in a pseudo-differential 4:1 mode, where the CMx pins function as common-mode pins and all four analog inputs are referred to the corresponding CMx pin.

The ADS8363, ADS7263, and ADS7223 also include a 2.5-V internal reference. This reference drives two independently-programmable, 10-bit digital-to-analog converters (DACs), allowing the voltage at each of the REFIOx pins to be adjusted through the internal REFDACx registers in 2.44-mV steps. A low-noise, unity-gain operational amplifier buffers each of the DAC outputs and drives the REFIOx pin.

The ADS8363, ADS7263, and ADS7223 provide a serial interface that is compatible with the ADS8361. However, instead of the ADS8361 A0 pin that controls the channel selection, the ADS8363, ADS7263, and ADS7223 offers a serial data input (SDI) pin that supports additional functions described in the [Digital](#) section of this data sheet (also see the section).

8.2 Functional Block Diagram

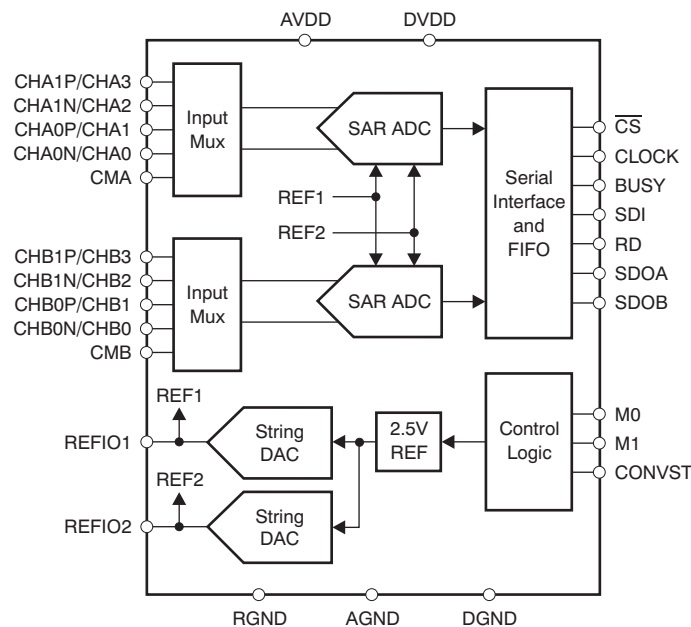

8.3 Feature Description

8.3.1 Analog

This section discusses the analog input circuit, the ADCs, and the reference design of the device.

8.3.1.1 Analog Inputs

Each ADC is fed by an input multiplexer, as shown in Figure 27. Each multiplexer is used in either a fully-differential 2:1 configuration (as shown in Table 1) or a pseudo-differential 4:1 configuration (as shown in Table 2).

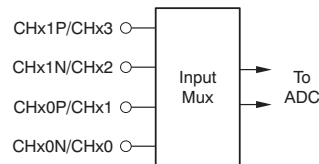

Figure 27. Input Multiplexer Configuration

Channel selection is performed using either the external M0 pin or the C[1:0] bits in the Configuration (CONFIG) register in fully-differential mode, or using the SEQFIFO register in pseudo-differential mode. In either case, changing the multiplexer settings impacts the conversion started with the next CONVST pulse.

Table 1. Fully-Differential 2:1 Multiplexer Configuration

C1	C0	ADC+	ADC–
0	x	CHx0P	CHx0N
1	x	CHx1P	CHx1N

Table 2. Pseudo-Differential 4:1 Multiplexer Configuration

C1	C0	ADC+	ADC–
0	0	CHx0	CMx/REFIOx
0	1	CHx1	CMx/REFIOx
1	0	CHx2	CMx/REFIOx
1	1	CHx3	CMx/REFIOx

The input path for the converter is fully differential and provides a good common-mode rejection of 92 dB at 100 kHz (for the ADS8363). The high CMRR also helps suppress noise in harsh industrial environments.

Each of the 40-pF sample-and-hold capacitors (C_S in Figure 28) is connected through switches to the multiplexer output. Opening the switches holds the sampled data during the conversion process. After the conversion completes, both capacitors are precharged for the duration of one clock cycle to the voltage present at the REFIOx pin. After precharging, the multiplexer outputs are connected to the sampling capacitors again. The voltage at the analog input pin is usually different from the reference voltage; therefore, the sample capacitors must be charged to within one-half LSB for 16-, 14-, or 12-bit accuracy during the acquisition time t_{ACQ} (see Figure 1 and Figure 2).

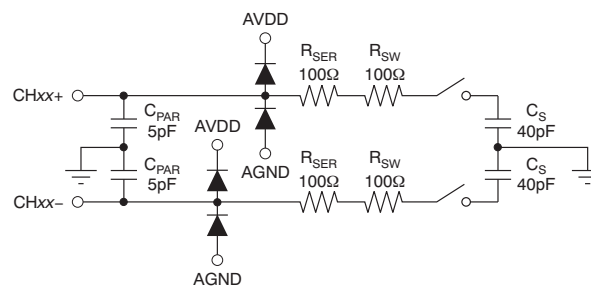

Figure 28. Equivalent Analog Input Circuit

Feature Description (continued)

Acquisition is indicated with the BUSY signal being low. Acquisition starts by closing the input switches (after finishing the previous conversion and precharging) and finishes with the rising edge of the CONVST signal. If the device operates at full speed, the acquisition time is typically 100 ns.

The minimum –3-dB bandwidth of the driving operational amplifier can be calculated as shown in [Equation 1](#), with $n = 16$ for the resolution of the ADS8363, $n = 14$ for the ADS7263, or $n = 12$ for the ADS7223:

$$f_{-3dB} = \frac{\ln(2)(n + 1)}{2\pi t_{ACQ}} \quad (1)$$

With $t_{ACQ} = 100$ ns, the minimum bandwidth of the driving amplifier is 19 MHz for the ADS8363, 17 MHz for the ADS7263, and 15 MHz for the ADS7223. The required bandwidth can be lower if the application allows a longer acquisition time.

A gain error occurs if a given application does not fulfill the settling requirement shown in [Equation 1](#). However, linearity and THD are not directly affected as a result of precharging the capacitors.

The [OPA365](#) from Texas Instruments is recommended as a driver; in addition to offering the required bandwidth, the OPA365 also provides a low offset and excellent THD performance (see the [Application and Implementation](#) section).

The phase margin of the driving operational amplifier is usually reduced by the ADC sampling capacitor. A resistor placed between the capacitor and the amplifier limits this effect; therefore, an internal 100-Ω resistor (R_{SER}) is placed in series with the switch. The switch resistance (R_{SW}) is typically 100 Ω; see [Figure 28](#).

An input driver may not be required, if the impedance of the signal source (R_{SOURCE}) fulfills the requirement of [Equation 2](#):

$$R_{SOURCE} < \frac{t_{ACQ}}{C_S \ln(2)(n + 1)} - (R_{SER} + R_{SW})$$

where

- $n = 16, 14, 12$ for the resolution of the ADS8363, ADS7263, and ADS7223, respectively
- $C_S = 40$ -pF sample capacitance
- $R_{SER} = 100$ -Ω input resistor value
- $R_{SW} = 100$ -Ω switch resistance value

(2)

With $t_{ACQ} = 100$ ns, the maximum source impedance must be less than 12 Ω for the ADS8363, less than 40 Ω for the ADS7263, and less than 77 Ω for the ADS7223. The source impedance can be higher if the ADC is used at a lower data rate.

The differential input voltage range of the ADC is $\pm V_{REF}$, the voltage at the selected REFIOx pin.

The voltage to all inputs must be kept within the 0.3-V limit below AGND and above AVDD, without allowing dc current to flow through the inputs (exceeding these limits causes the internal ESD diodes to conduct, leading to increased leakage current that may damage the device). Current is only necessary to recharge the sample-and-hold capacitors.

Unused inputs must be directly tied to AGND or RGND without the need of a pull-down resistor.

8.3.1.2 Analog-to-Digital Converters (ADCs)

The ADS8363, ADS7263, and ADS7223 include two SAR-type, 1 MSPS, 16-, 14-, and 12-bit ADCs that include sample-and-hold, respectively; see the [Functional Block Diagram](#) section.

8.3.1.3 CONVST

The analog inputs are held with the rising edge of the CONVST (conversion start) signal. The setup time of CONVST referred to the next rising edge of CLOCK (system clock) is 12 ns (minimum). The conversion automatically starts with the rising CLOCK edge. Do not issue a rising edge of CONVST during a conversion (that is, when BUSY is high).

Feature Description (continued)

RD (read data) and CONVST can be shorted to minimize necessary software and wiring. The RD signal is triggered by the device on the falling edge of CLOCK. Therefore, the combined signals must be activated with the rising CLOCK edge. The conversion then starts with the subsequent rising CLOCK edge. In modes with only SDOA active (that is, in modes II, IV, SII, and SIV), the maximum length of the combined RD and CONVST signal is one clock cycle if the half-clock timing is used.

If CONVST and RD are combined, \overline{CS} must be low whenever a new conversion starts; however, this condition is not required if RD and CONVST are controlled separately. Note that if FIFO is used, CONVST must be controlled separately from RD.

After completing a conversion, the sample capacitors are automatically precharged to the value of the reference voltage used to significantly reduce the crosstalk among the multiplexed input channels.

8.3.1.4 CLOCK

The ADS8363, ADS7263, and ADS7223 use an external clock with an allowable frequency range that depends on the mode being used. By default (after power-up), the ADC operates in half-clock mode that supports a clock in the range of 0.5 MHz to 20 MHz. In full-clock mode, the ADC requires a clock in the range of 1 MHz to 40 MHz. For maximum data throughput, the clock signal must be continuously running. However, in applications that use the device in burst mode, the clock can be held static low or high upon completion of the read access and before starting a new conversion.

The CLOCK duty cycle must be 50%. However, the device functions properly with a duty cycle between 30% and 70%.

8.3.1.5 RESET

The ADS8363, ADS7263, and ADS7223 feature an internal power-on reset (POR) function. A user-controlled reset can also be issued using SDI register bits A[3:0] (see the [Digital](#) section).

8.3.1.6 REFIOx

The ADS8363, ADS7263, and ADS7223 include a low-drift, 2.5-V internal reference source. This source feeds two, 10-bit string DACs that are controlled through registers. As a result of this architecture, the reference voltages at REFIOx are programmable in 2.44-mV steps and can be adjusted to the application requirements without the use of additional external components. The actual output voltage can be calculated using [Equation 3](#), with code being the decimal value of the REFDACx register content:

$$V_{REF} = \frac{2.5V(\text{code} + 1)}{1024} \quad (3)$$

The reference DAC has a fixed transition at the code 508 (0x1FC). At this code, the DAC can show a jump of up to 10 mV in the transfer function. [Table 3](#) lists some examples of internal reference DAC settings. However, to ensure proper performance, the REFDACx output voltage must not be programmed below 0.5 V.

Table 3. REFDACx Setting Examples

VREFOUT (NOM)	DECIMAL CODE	BINARY CODE	HEXADECIMAL CODE
0.5000 V	205	00 1100 1101	0CDh
1.2429 V	507	01 1111 1100	1FBh
1.2427 V	508	01 1111 1101	1FCh
2.5000 V	1023	11 1111 1111	3FFh

A minimum of 22- μ F capacitance is required on each REFIOx output to keep the references stable. The settling time is 8 ms (maximum) with the reference capacitor connected. Smaller reference capacitance values reduce the DNL, INL, and ac performance of the device. By default, both reference outputs are disabled and the respective values are set to 2.5 V after power-up.

Feature Description (continued)

For applications that use an external reference source, the internal reference can be disabled (default) using the RPD bit in the CONFIG register (see the [Digital](#) section). The REFIOx pins are directly connected to the ADC; therefore, the internal switching generates spikes that can be observed at this pin. Therefore, also in this case, an external 22- μ F capacitor to the analog ground (AGND) must be used to stabilize the reference input voltage.

Disabled REFIOx pins can be left floating or can be directly tied to AGND or RGND.

Each of the reference DAC outputs can be individually selected as a source for each channel input using the Rxx bits in the REFCM register. [Figure 29](#) shows a simplified block diagram of the internal circuit.

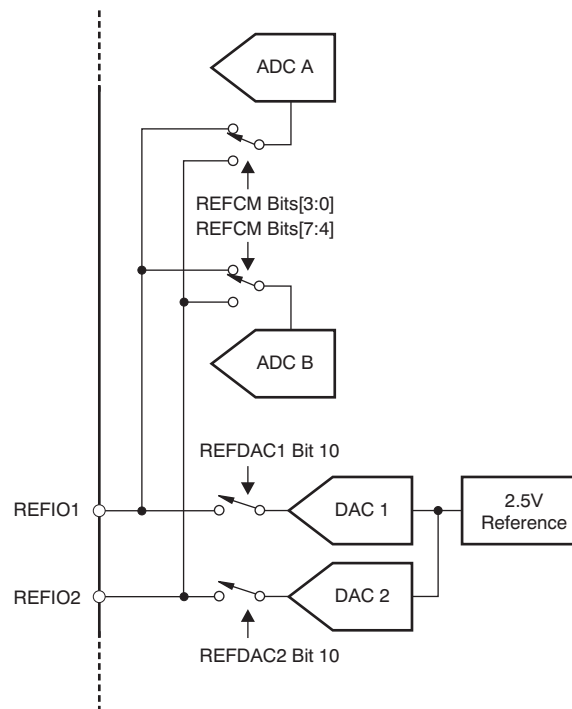

Figure 29. Reference Selection Circuit

8.3.2 Digital

This section reviews the timing and control of the serial interface.

The ADS8363, ADS7263, and ADS7223 offer a set of internal registers (see the [Register Maps](#) section for details) that allows the control of several features and modes of the device, as [Table 4](#) shows.

Table 4. Supported Operating Modes

INPUT SIGNAL TYPE	MANUAL CHANNEL SELECTION	AUTOMATIC CHANNEL SELECTION
Fully-differential (PDE bit = '0')	Operating modes: I, II, and special mode II Channel information selectable through CID bit FIFO: not available	Operating modes: III, IV and special mode IV Channel information selectable through CID bit FIFO: available in mode III and special mode IV; when used, a single read pulse allows reading of all data
Pseudo-differential (PDE bit = '1')	Operating modes: I, II and special mode II Channel information selectable through CID bit FIFO: not available	Operating modes: III and special mode IV Channel information not available (CID bit forced to '1') FIFO: available in mode III and special mode IV; when used, a single read pulse allows reading of all data Pseudo-differential sequencer is enabled

8.3.2.1 Mode Selection Pin M0 and M1

The ADS8363, ADS7263, and ADS7223 can be configured to four different operating modes by using mode pins M0 and M1, as shown in [Table 5](#).

Table 5. M0, M1 Truth Table

M0	M1	CHANNEL SELECTION	SDO _x USED
0	0	Manual (through SDI)	SDOA and SDOB
0	1	Manual (through SDI)	SDOA only
1	0	Automatic	SDOA and SDOB
1	1	Automatic	SDOA only

The M0 pin sets either manual or automatic channel selection. In Manual mode, CONFIG register bits C[1:0] are used to select between channels CHx0 and CHx1. In Automatic mode, CONFIG register bits C[1:0] are ignored and channel selection is controlled by the device after each conversion. The automatic channel selection is only performed on fully-differential inputs in this case; for pseudo-differential inputs, the internal sequencer controls the input multiplexer.

The M1 pin selects between serial data being transmitted simultaneously on both SDOA and SDOB outputs for each channel, respectively, or using only the SDOA output for transmitting data from both channels (see [Figure 31](#) through [Figure 36](#) and the associated text for more information).

Additionally, the SDI pin is used for controlling device functionality through the internal register; see the [Register Maps](#) section for details.

8.3.2.2 Half-Clock Mode (Default Mode After Power-Up and Reset)

The ADS8363, ADS7263, and ADS7223 power up in half-clock mode, in which the ADC requires at least 20 CLOCKS for a complete conversion cycle, including the acquisition phase. The conversion result can only be read during the next conversion cycle. The first output bit is available with the falling RD edge, and the following output data bits are refreshed with the rising edge of CLOCK.

8.3.2.3 Full-Clock Mode (Allowing Conversion and Data Readout Within 1 μ s, Supported In Dual Output Modes)

The full-clock mode allows converting data and reading the result within 1 μ s. The entire cycle requires 40 CLOCKS. The first output bit is available with the falling RD edge and the following output data bits are refreshed with the falling edge of the CLOCK in this mode.

The full-clock mode can only be used with analog power supply AVDD in the range of 4.5 V to 5.5 V and digital supply DVDD in the range of 2.3 V to 3.6 V. The internal FIFO is disabled in full-clock mode.

8.3.2.4 2-Bit Counter

These devices offers a selectable 2-bit counter (activated using the CE bit in the CONFIG register) that is a useful feature in safety applications. The counter value automatically increments whenever a new conversion result is stored in the output register, indicating a new value. The counter default value after power-up is '01' (followed by '10', '11', '00', '01', and so on); see [Figure 40](#). Because the counter value increments only when a new conversion results are transferred to the output register, this counter is used to verify that the ADC has performed a conversion and the data read is the result of this new conversion (not a old result read multiple times).

8.4 Device Functional Modes

8.4.1 Power-Down Modes and Reset

These devices have a comprehensive built-in power-down feature. There are three power-down modes: Power-Down, Sleep, and Auto-Sleep Power-Down. All three power-down modes are activated with the completion of the write access, during which the related bits are asserted (PD[1:0]). All modes are deactivated by deasserting the respective bits in the CONFIG register. The content of the CONFIG register is not affected by any of the power-down modes. Any ongoing conversion is finished before entering any of the power-down modes. [Table 6](#) summarizes the differences among the three power-down modes.

Table 6. Power-Down Modes

POWER-DOWN MODE	POWER-DOWN CURRENT	POWER-DOWN ENABLED BY	POWER-DOWN START BY	DELAY TIME TO POWER-DOWN	NORMAL OPERATION BY	WAKEUP TIME	POWER-DOWN DISABLED BY
Power-Down	5 μ A	PD[1:0] = '01'	Write access completed	20 μ s	PD[1:0] = '00'	8 ms	PD[1:0] = '00'
Sleep	1.2 mA (3.6 V)	PD[1:0] = '10'	Write access completed	10 μ s	PD[1:0] = '00'	7 or 14 CLOCK cycles	PD[1:0] = '00'
Auto-Sleep	1.2 mA (3.6 V)	PD[1:0] = '11'	Each end of conversion	10 μ s	CONVST pulse	7 or 14 CLOCK cycles	PD[1:0] = '00'

8.4.1.1 Power-Down Mode

In Power-Down mode (PD[1:0] = '01'), all functional blocks except the digital interface are disabled. In this mode, the current demand is reduced to 5 μ A within 20 μ s. The wakeup time from Power-Down mode is 8ms when using a reference capacitor of 22 μ F. The device goes into Power-Down mode after completing any ongoing conversions.

8.4.1.2 Sleep Mode

In Sleep mode (PD[1:0] = '10'), the device reduces the current demand to approximately 0.9 mA within 10 μ s. The device goes into Sleep mode after completing any ongoing conversions.

8.4.1.3 Auto-Sleep Mode

Auto-Sleep mode is almost identical to Sleep mode. The only differences are the method of activating the mode and waking up the device. CONFIG register bits PD[1:0] = '11' are only used to enable or disable this feature. If the Auto-Sleep mode is enabled, the device automatically turns off the biasing after finishing a conversion; thus, the end of conversion actually activates Auto-Sleep mode. If Sequencer mode is used and individual conversion start pulses are chosen (S1 = '0'), the device automatically powers-down after each conversion; in case of a single CONVST pulse starting the sequence (S1 = '1'), power-down is activated upon completion of the entire sequence.

The device wakes up with the next CONVST pulse but the analog input is held in sample mode for another seven clock cycles in half-clock mode, or 14 clock cycles in full-clock mode, before starting the actual conversion (BUSY goes high thereafter); see [Figure 30](#). This time is required to settle the internal circuitry to the required voltage levels. The conversion result is delayed in Auto-Sleep mode; see [Figure 36](#).

In this mode, the current demand is reduced to approximately 1.2 mA within 10 μ s.

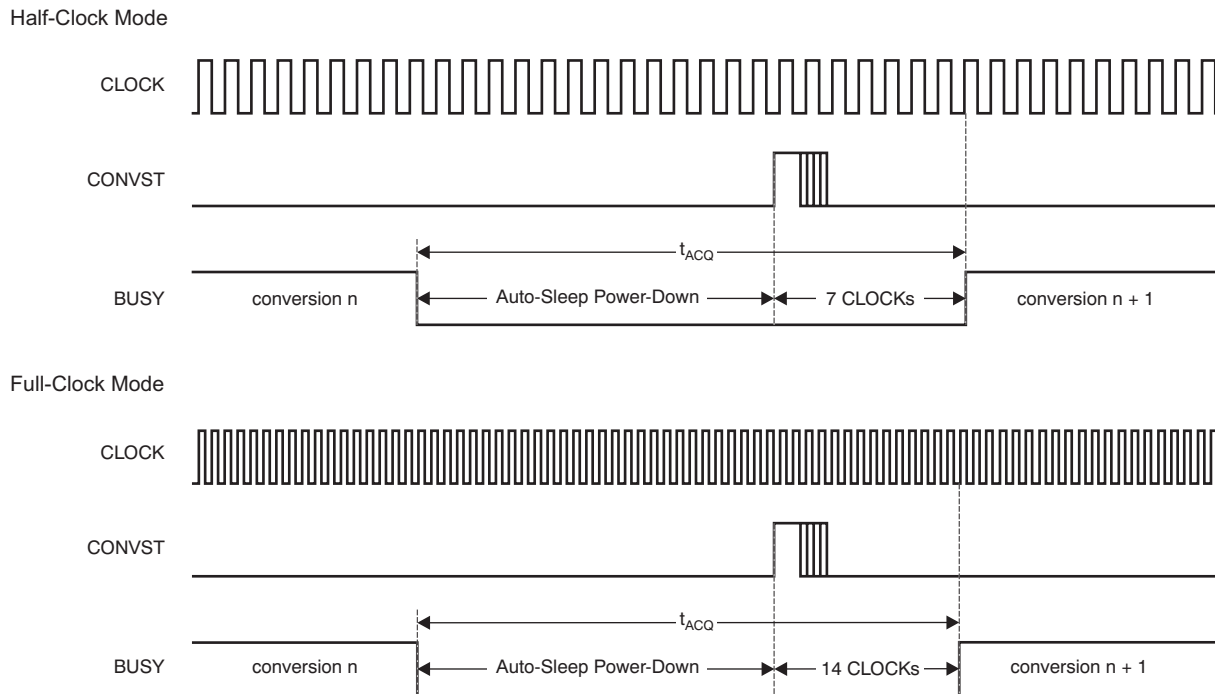

Figure 30. Actual Conversion Start In Auto-Sleep Mode

8.4.1.4 Reset

To issue a device reset, an RD pulse must be generated along with a control word containing $A[3:0] = '0100'$. With the completion of this write access, the entire device including the serial interface is forced into reset, interrupting any ongoing conversions, setting the input into acquisition mode, and returning the register contents to their default values. After approximately 20 ns, the serial interface becomes active again. The device also supports an automatic power-up reset (POR) that ensures proper (default) settings of the device.

8.5 Programming

8.5.1 Read Data Input (RD)

The RD input is used to control serial data outputs SDOx. The falling edge of the RD pulse triggers the output of the first bit of the output data. When CID = '0', the first bit of output data on SDOx is the analog input channel indicator; when CID = '1', the first bit of output data on SDOx is the MSB of the conversion result, or the 15th bit of the selected register, followed by output bits that are updated with the rising edge of the CLOCK in half-clock mode, or falling edge of the CLOCK in full-clock mode.

The RD input can be controlled separately or in combination with the CONVST input (see [Figure 48](#) for a detailed timing diagram of this case). If RD is controlled separately, RD can be issued whenever a conversion process is finished (that is, after the falling edge of BUSY). However, in order to achieve the maximum data rate, the conversion results must be read during an ongoing conversion. In this case, the RD pulse must not be issued between the 16th and 19th clock cycle in half-clock mode, or between the 34th and 36th clock cycle in full-clock mode, after starting the conversion.

If a read access is repeated without issuing a new conversion, the result of the last conversion is presented on the outputs again. A repeated readout must only be performed when BUSY is low.

Note that in full-clock mode, only the first read access delivers the correct channel information (if CID = '0' in the CONFIG register), when the following readouts contain invalid channel details. The channel information is corrected with the next conversion.

Read access to verify the content of the internal registers is described in the [Register Maps](#) section.

8.5.2 Serial Data Outputs (SDOx)

The following sections explain the different modes of operation in detail.

The digital output code format of the ADS8363, ADS7263, and ADS7223 is binary twos complement, as shown in [Table 7](#).

Consider both detailed timing diagrams ([Figure 1](#) and [Figure 2](#)) illustrated in [Figure 1](#) and [Figure 2](#). For maximum data throughput, the description and diagrams given in this document assume that the CONVST and RD pins are tied together; see [Figure 48](#) for timing details in this case. Note that these pins can also be controlled independently.

Table 7. Output Data Format

DESCRIPTION	DIFFERENTIAL INPUT VOLTAGE	INPUT VOLTAGE AT CH _{xx} P (CH _{xx} N = V _{REF} = 2.5 V)	BINARY CODE	HEXADECIMAL CODE
Positive full-scale	V _{REF}	5 V	ADS8363: 0111 1111 1111 1111	7FFF
			ADS7263: 0111 1111 1111 1100	7FFC
			ADS7223: 0111 1111 1111 0000	7FF0
Midscale	0 V	2.5 V	0000 0000 0000 0000	0000
Midscale – 1 LSB	–2V _{REF} / resolution	ADS8363: 2.499924 V	ADS8363: 1111 1111 1111 1111	FFFF
		ADS7263: 2.499695 V	ADS7263: 1111 1111 1111 1100	FFFC
		ADS7223: 2.498779 V	ADS7223: 1111 1111 1111 0000	FFF0
Negative full-scale	–V _{REF}	0 V	1000 0000 0000 0000	8000

8.5.2.1 Mode I

With the M0 and M1 pins both set to '0', the device enters manual channel-control operation and outputs data on both SDOA and SDOB, accordingly. The SDI pin can be used to switch between the channels, as explicitly shown in the corresponding timing diagrams. A conversion is initiated by bringing CONVST high.

With the rising edge of CONVST, the device switches asynchronously to the external CLOCK from sample to hold mode, and the BUSY output pin goes high and remains high for the duration of the conversion cycle. On the falling edge of the second CLOCK cycle, the device latches in the channel for the next conversion cycle, depending on the status of CONFIG register bits C[1:0]. CS must be brought low to enable both serial outputs. Data are valid on the falling edge of every 20 clock cycles per conversion. The first two bits are set to '0'. The subsequent data contain the 16-, 14-, or 12-bit conversion result (the most significant bit is transferred first), with trailing zeroes, as shown in Figure 31.

This mode can be used for fully- or pseudo-differential inputs; in both cases, channel information bits are '00' if CID = '0'. Note that FIFO is not available in this mode.

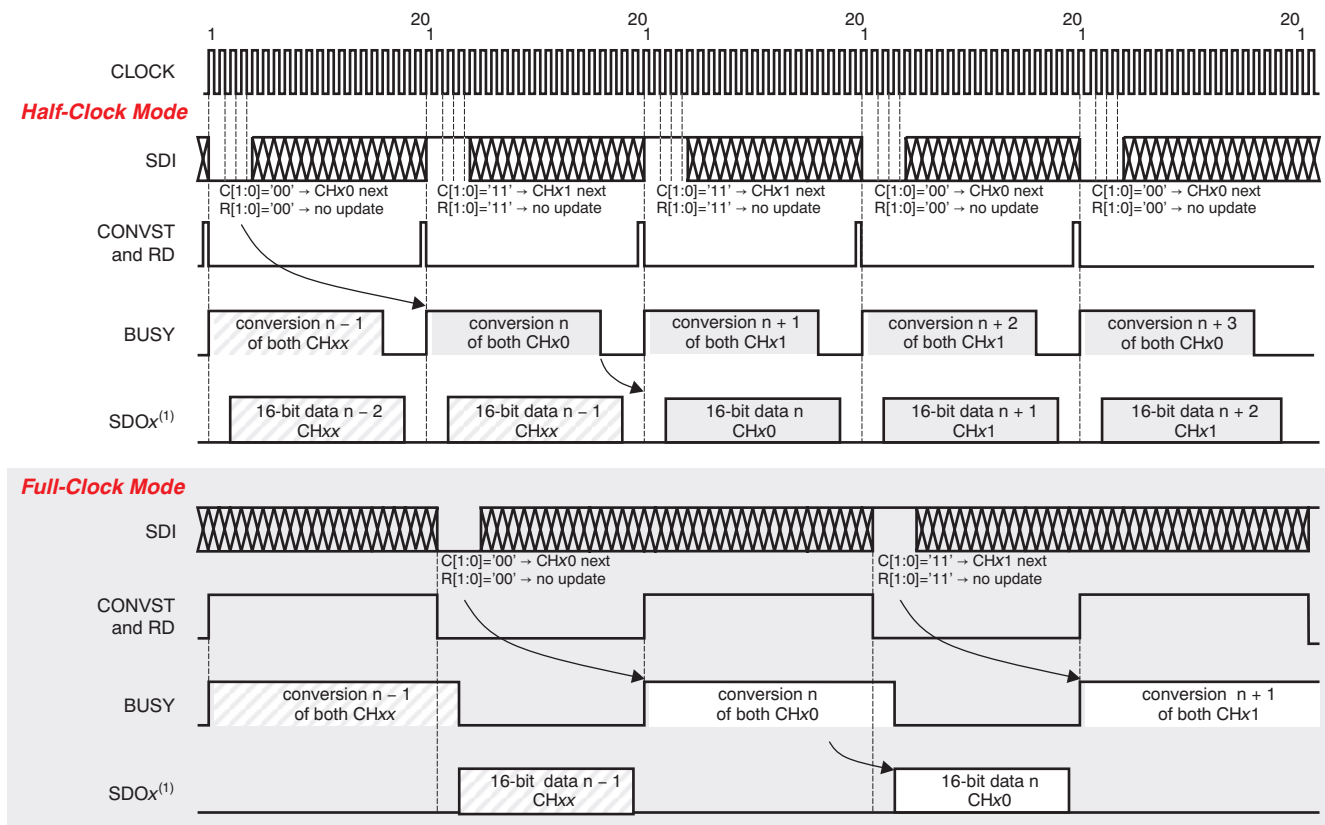

(1) The ADS7263 and ADS7223 output data with the MSB located as the ADS8363 and the last 2 or 4 bits are '0'.

Figure 31. Mode I Timing
(M0 = '0', M1 = '0', PDE = '0', CID = '1', Fully-Differential Example)

8.5.2.2 Mode II (Half-Clock Mode Only)

With M0 = '0' and M1 = '1', the ADS8363, ADS7263, and ADS7223 also operate in manual channel-control mode and output data on the SDOA pin only when SDOB is set to high impedance. All other pins function in the same manner as they do in Mode I.

In half-clock mode, because 40 clock cycles are required to output the results from both ADCs (instead of 20 cycles if M1 = '0'), the device requires 2.0 μs to perform a complete read cycle. If the CONVST signal is issued every 1.0 μs (required for the RD signal) as in Mode I, every second pulse is ignored, as shown in Figure 32. CONVST and RD signals must not be longer than one clock cycle to ensure proper functionality and avoid corruption of output data.

Full-clock mode is not supported in this operational mode.

The output data consist of a '0', followed by an ADC indicator ('0' for CHAx or '1' for CHBx), and then 16, 14, or 12 bits of conversion result along with any trailing zeroes.

This mode can be used for fully- or pseudo-differential inputs. Channel information is valid in fully-differential mode only if CID = '0' (CID contains correct ADC information when the channel bit is invalid in pseudo-differential mode). Note that FIFO is not available in this mode.

Changes to register bits FE, SR, PDE, and CID are active with the start of the next conversion. with a delay of one read access.

The register settings must be updated using every other RD pulse, aligned either with the one starting the conversion or the one to read the conversion results of channel B, as shown in Figure 32.

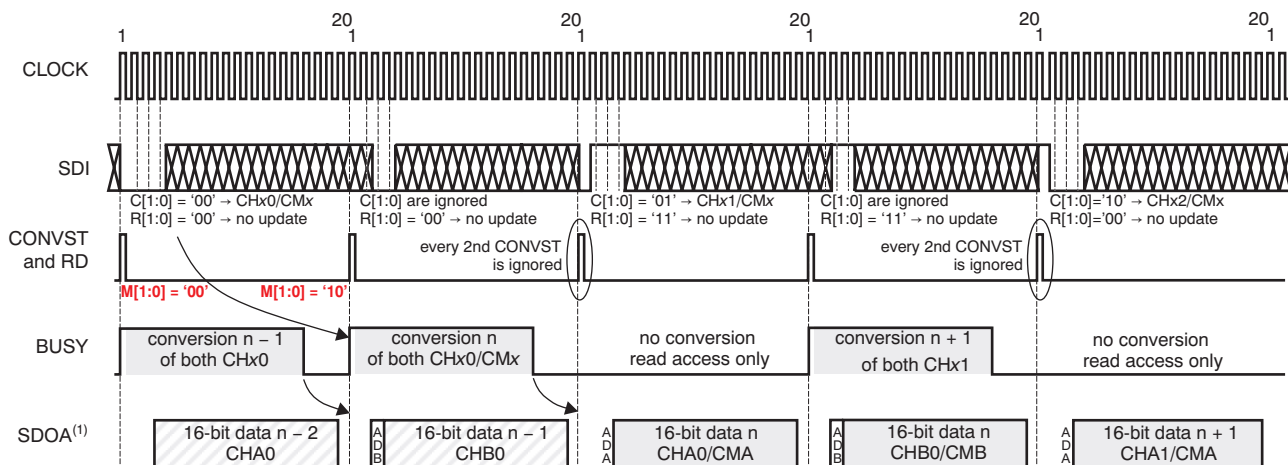

(1) The ADS7263 and ADS7223 output data with the MSB located as the ADS8363 and the last 2 or 4 bits are '0'.

Figure 32. Mode II Timing
(M0 = '0', M1 = '1', PDE = '0', CID = '0', Pseudo-Differential Example)

8.5.2.3 Special Read Mode II (Half-Clock Mode Only)

For Mode II, a special read mode is available in the ADS8363, ADS7263, and ADS7223 where both data results can be read out triggered by a single RD pulse (see Figure 33). To activate this mode, The SR bit in the CONFIG register must be set to '1' (see Table 8). The CONVST and RD pins can still be tied together but are issued every 40 CLOCK cycles instead of 20. Output data are presented on SDOA only when SDOB is held in 3-state.

The RD signal in this mode must not be longer than one clock cycle to avoid corruption of output data.

This special mode can be used for fully- or pseudo-differential inputs. Channel information is valid in fully-differential mode only if CID = '0' (CID contains correct ADC information when the channel bit is invalid in pseudo-differential mode). Note that FIFO is not available in this mode.

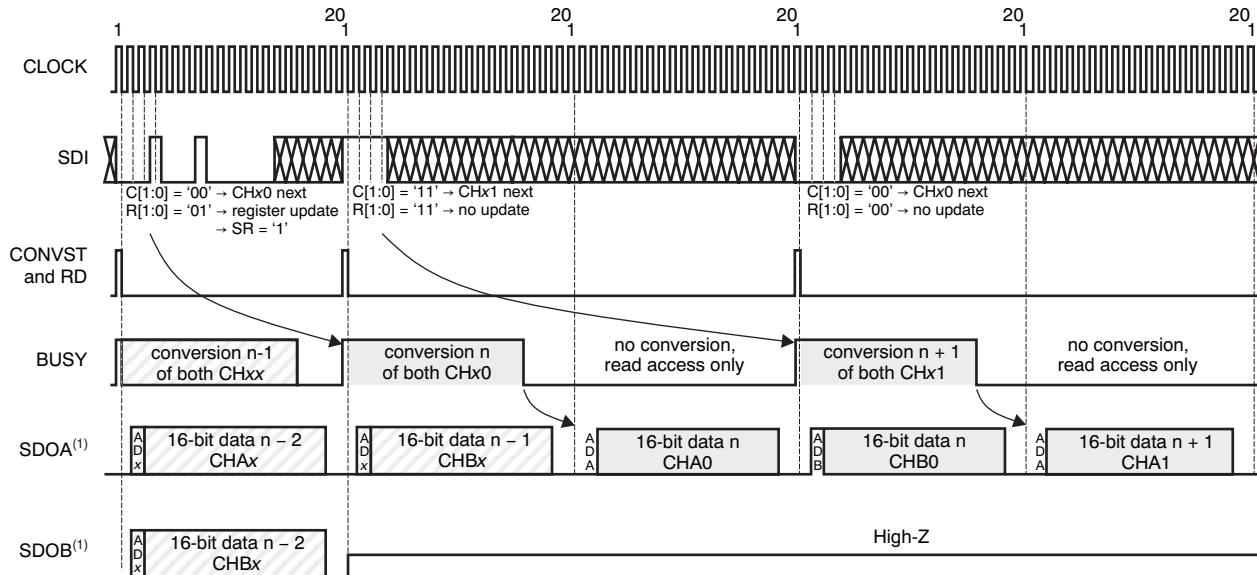

(1) The ADS7263 and ADS7223 output data with the MSB located as the ADS8363 and the last 2 or 4 bits are '0'.

Figure 33. Special Read Mode II Timing Diagram
 (M0 = '0', M1 = '1', PDE = '0', SR = '1', CID = '0', Fully-Differential Example)

8.5.2.4 Mode III

With M0 = '1' and M1 = '0', the device automatically cycles between the differential inputs (CONFIG register bits C[1:0] are ignored) when offering the conversion result of CHAx on SDOA and the conversion result of CHBx on SDOB, as shown in Figure 34.

Output data consist of a channel indicator ('0' for CHx0, or '1' for CHx1), followed by a '0', and then 16, 14, or 12 bits of conversion result along with any trailing zeroes.

This mode can be used for fully- or pseudo-differential inputs (in pseudo-differential mode the sequencer is used to control the input multiplexer). Channel information is available in fully-differential mode only if CID = '0' (CID is forced to '1' in pseudo-differential mode).

The internal FIFO is available in this mode; when used, a single read pulse allows for reading of all stored conversion data. The FIFO must be completely filled when used for the first time in order to ensure proper functionality.

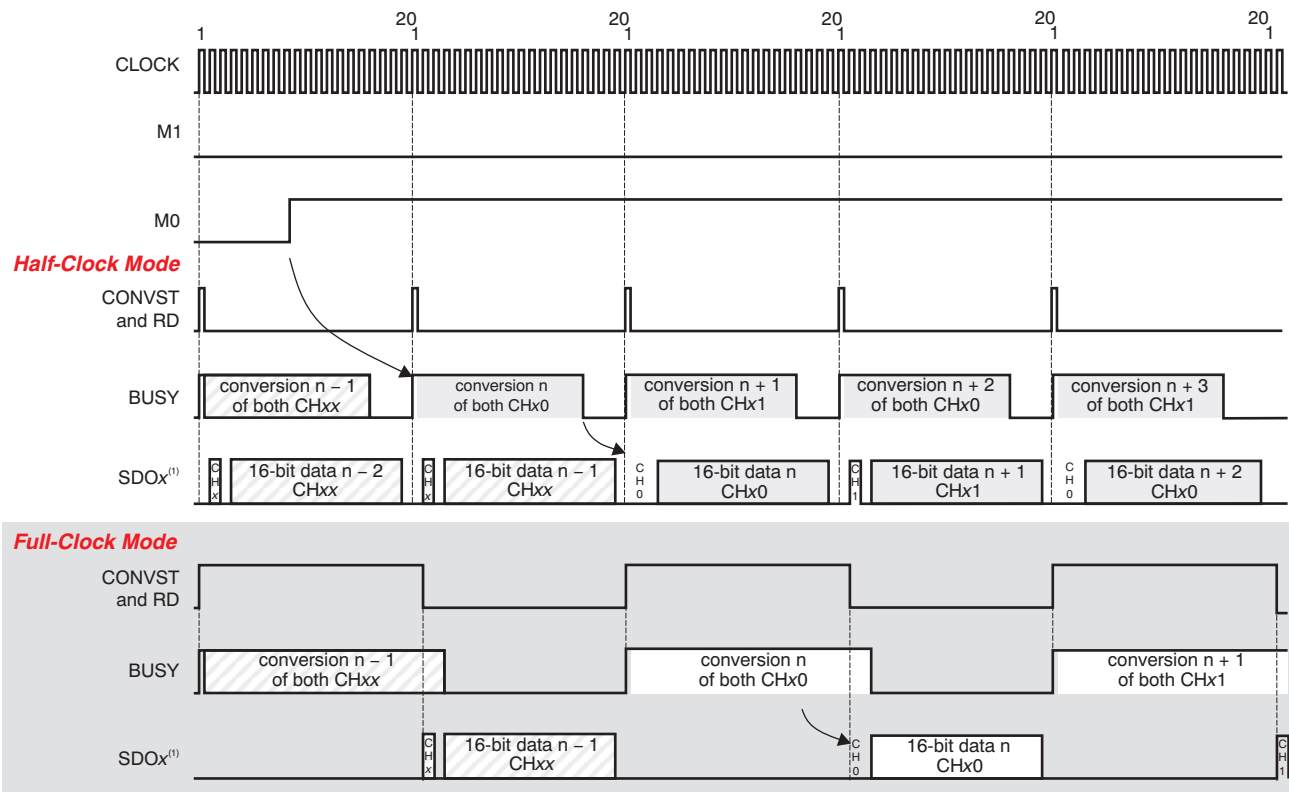

(1) The ADS7263 and ADS7223 output data with the MSB located as the ADS8363 and the last 2 or 4 bits are '0'.

Figure 34. Mode III Timing
(M0 = '1', M1 = '0', PDE = '0', CID = '0', Fully-Differential Example)

8.5.2.5 Fully-Differential Mode IV (Half-Clock Mode Only)

In the same way as Mode II, Mode IV uses the SDOA output line exclusively to transmit data when the differential channels are switched automatically. Following the first conversion after M1 goes high, the SDOB output 3-states, as shown in Figure 35.

Output data consist of a channel indicator ('0' for CHx0, or '1' for CHx1), followed by the ADC indicator ('0' for CHAx or '1' for CHBx), and then 16 or 14 bits of conversion result, ending with '00' for the ADS8363, '0000' for the ADS7263, or '000000' for the ADS7223.

CONVST and RD signals must not be longer than one clock cycle to ensure proper functionality and avoid corruption of output data.

Full-clock mode is not supported in this operational mode.

Channel information is available in fully-differential mode if CID = '0'. In pseudo-differential mode, the sequencer controls the channel selection in this mode and must be set appropriately using the SEQFIFO register. The internal FIFO is not available in this mode.

Changes to CONFIG register bits FE, SR, PDE, and CID are active with the start of the next conversion with a delay of one read access.

The register settings must be updated using every other RD pulse (aligned either with the one starting the conversion or the one to read the conversion results of channel B; compare with Figure 32).

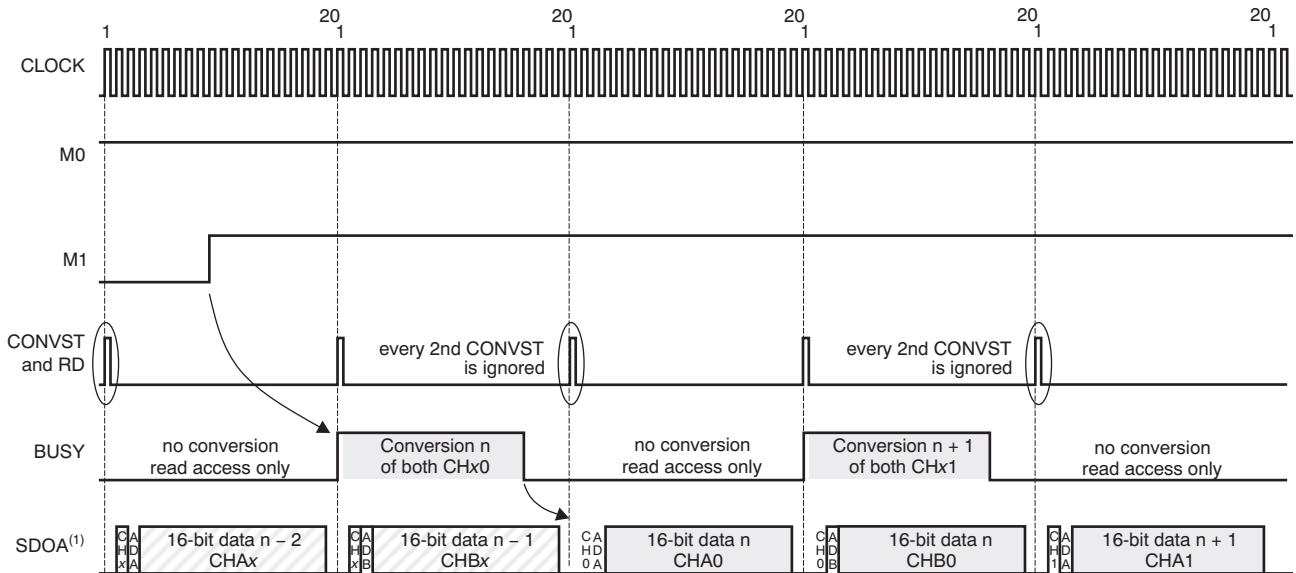

(1) The ADS7263 and ADS7223 output data with the MSB located as the ADS8363 and the last 2 or 4 bits are '0'.

Figure 35. Fully-Differential Mode IV Timing
(M0 = '1', M1 = '1', PDE = '0', and CID = '0' Example)

8.5.2.6 Special Mode IV (Half-Clock Mode Only)

As with Special Mode II, these devices also offer a special read mode for Mode IV, where both data results of a conversion can be read by triggering a single RD pulse, as shown in Figure 36. Additionally, in this case, the SR bit in the CONFIG register must be set to '1' and the CONVST and RD pins can still be tied together, but are issued every 40 CLOCK cycles instead of 20. The RD signal in this mode must not be longer than one clock cycle to avoid corruption of output data.

Data are available on the SDOA pin, accordingly.

If auto-sleep power-down mode is enabled, the conversion results are presented during the next conversion, as shown in Figure 36.

This mode can be used for fully- or pseudo-differential inputs (note that in pseudo-differential mode, the sequencer is used to control the input multiplexer); channel information is available if CID = '0' in fully-differential mode only (CID forced to '1' in pseudo-differential mode).

The internal FIFO is available in this mode; when used, a single read pulse allows for reading of all stored conversion data. The FIFO must be completely filled when used for the first time in order to ensure proper functionality.

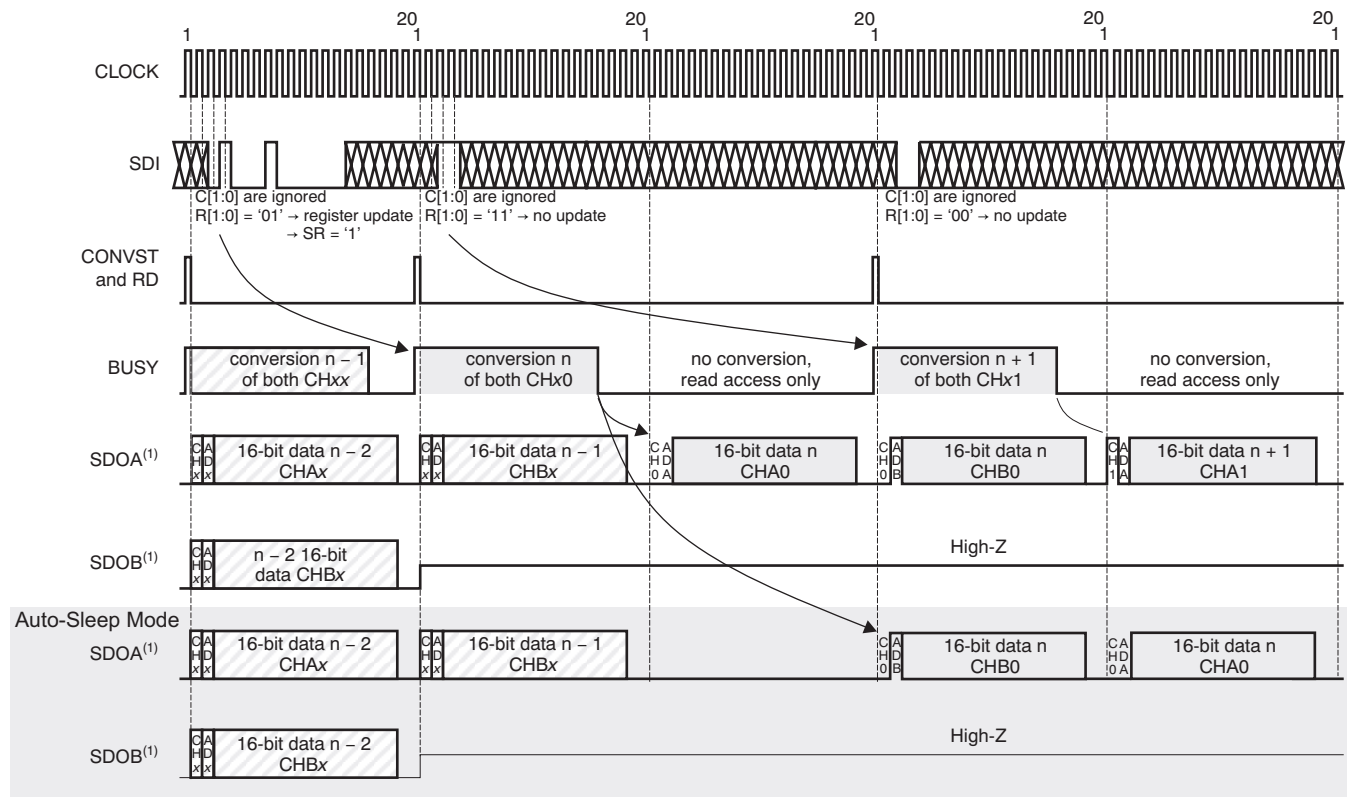

(1) The ADS7263 and ADS7223 output data with the MSB located as the ADS8363 and the last 2 or 4 bits are '0'.

Figure 36. Special Read Mode IV Timing
(M0 = '1', M1 = '1', PDE = '0', SR = '1', CID = '0', Fully-Differential Example)

8.5.3 Programming the Reference DAC

The internal reference DACs can be set by issuing an RD pulse when providing a control word with R[1:0] = '01' and A[3:0] = 'X010' or 'X101', depending on which DAC is going to be updated. Thereafter, a second RD pulse must be generated with a control word that starts with the first five bits being ignored followed by the reference power control and the corresponding 10-bit DAC value, as shown in Figure 37.

To verify the DACs settings, an RD pulse must be generated when providing a control word containing R[1:0] = '01' and A[3:0] = '0011' or '0110' to initialize the read access of the appropriate DAC register. Triggering the RD line again causes the SDOA output to provide the 16-bit DAC register value followed by '0000', if channel information is disabled (CID = '0'). When channel information is enabled (CID = '1'), the first two bits of the data output contain the currently selected analog input channel indicator ('0' for CHx0 or '1' for CHx1), followed by the 16-bit DAC register contents and an additional '00'. Although the register contents are valid on SDOA, the conversion result of channel Ax is lost (if a conversion was performed in parallel), the conversion result of channel Bx is valid on SDOB (if enabled), and data on SDI are ignored, as shown in Figure 37).

The default value of the DAC registers after power-up is 7FFh, corresponding to a disabled reference voltage of 2.5 V on both REFIOx pins.

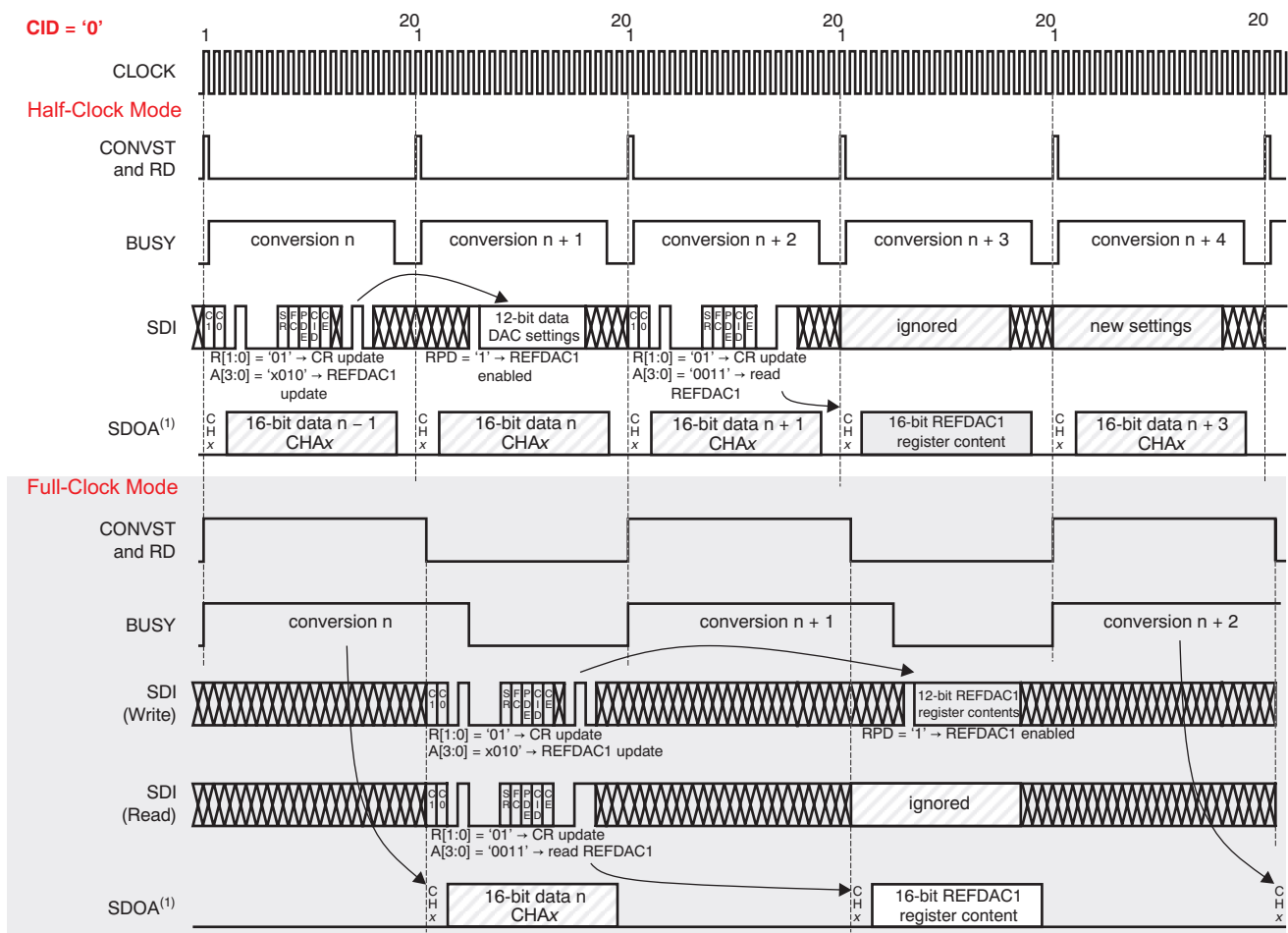

Figure 37. DAC Register Write and Read Access Timing (Both SDOx Active and CID = '0')

8.6 Register Maps

The ADS8363, ADS7263, and ADS7223 operation is controlled through a set of registers described in the following sections. [Table 8](#) shows the register map. The contents of these 16-bit registers can be set using the serial data input (SDI) pin, which is coupled to RD and clocked into the device on each falling edge of CLOCK. All data must be transferred MSB first. All register updates become active with the rising edge of CLOCK after completing the 16-clock-cycle write access operation.

Table 8. Register Map

REGISTER	BIT 15	BIT 14	BIT 13	BIT 12	BIT 11	BIT 10	BIT 9	BIT 8	BIT 7	BIT 6	BIT 5	BIT 4	BIT 3	BIT 2	BIT 1	BIT 0
CONFIG	C1	C0	R1	R0	PD1	PD0	FE	SR	FC	PDE	CID	CE	A3	A2	A1	A0
REFDAC1	0	0	0	0	0	RPD	D9	D8	D7	D6	D5	D4	D3	D2	D1	D0
REFDAC2	0	0	0	0	0	RPD	D9	D8	D7	D6	D5	D4	D3	D2	D1	D0
SEQFIFO	S1	S0	SL1	SL0	C11	C10	C21	C20	C31	C30	C41	C40	SP1	SP0	FD1	FD0
REFCM	CMB3	CMB2	CMB1	CMB0	CMA3	CMA2	CMA1	CMA0	RB3	RB2	RB1	RB0	RA3	RA2	RA1	RA0

To update the CONFIG register, a single write access is required. To update the contents of all the other registers, a write access to the control register with the appropriate register address (bits A[3:0]), followed by a write access to the actual register is required, as shown in [Figure 38](#). The CONFIG register contents can be updated when issuing a register read out access with a single register write access. For example, the mode of the device can be changed to full-clock mode when activating the REFDAC1 register read access; because full-clock mode is active upon the 16th clock cycle of the CONFIG register update, the REFDAC1 data are then presented according to the full-clock mode timing.

To verify the register contents, a read access can be issued using CONFIG register bits A[3:0]. Such access is described in the [Programming the Reference DAC](#) section, based on an example of verifying the reference DAC register settings. The register contents are always available on SDOA with the next read command. For example, if the FIFO is used, the register contents are presented after completion of the FIFO read access (see [Table 9](#) for more details). In both cases, a complete read or write access requires a total of 40 clock cycles, during which a new access to the CONFIG register is not allowed.

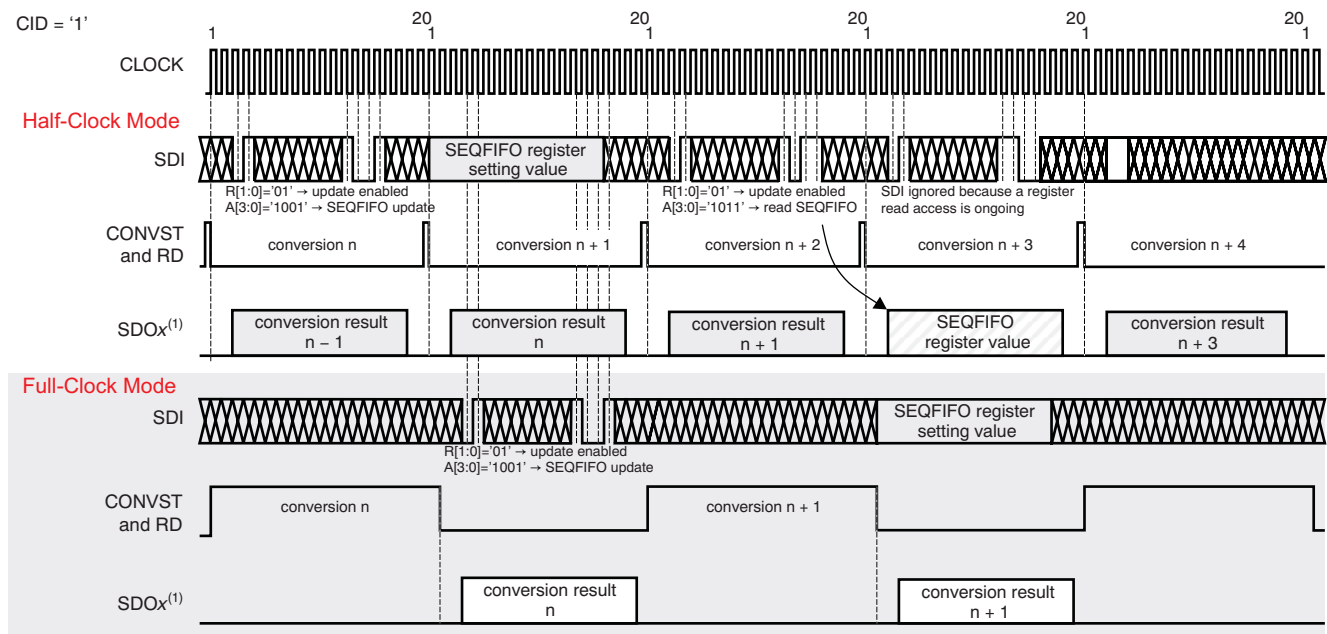

(1) The ADS7263 and ADS7223 output data with the MSB located as the ADS8363 and the last 2 or 4 bits are '0'.

**Figure 38. Updating Internal Register Settings
(Example: Half-Clock Mode, CID = '1')**

8.6.1 Configuration (Config) Register

The configuration register selects the input channel, the activation of power-down modes, and the access to the sequencer and FIFO, reference selection, and reference DAC registers.

Figure 39. Config: Configuration Register (Default = 0000h)

15 (MSB)	14	13	12	11	10	9	8	7	6	5	4	3	2	1	0 (LSB)
C1	C0	R1	R0	PD1	PD0	FE	SR	FC	PDE	CID	CE	A3	A2	A1	A0

Bits[15:14]
C[1:0]—Input Channel Selection (ADS8361-compatible).

These bits control the multiplexer input selection depending on the status of the PDE bit.

If PDE = '0' (default), the multiplexer is in fully-differential mode and bits C[1:0] control the input multiplexer in the following manner:

0x = conversion of analog signals at inputs CHx0P/CHx0N (default).

1x = conversion of analog signals at inputs CHx1P/CHx1N.

If PDE = '1', the multiplexer is in pseudo-differential mode and bits C[1:0] control the input multiplexer in the following manner:

00 = conversion of analog signal at input CHx0 versus the selected CMx or REFIOx (default).

01 = conversion of analog signal at input CHx1 versus the selected CMx or REFIOx.

10 = conversion of analog signal at input CHx2 versus the selected CMx or REFIOx.

11 = conversion of analog signal at input CHx3 versus the selected CMx or REFIOx.

Bits[13:12]
R[1:0]—Configuration register update control.

These bits control the access to the CONFIG register.

00 = If M0 = '0', update of input selection bits C[1:0] only (ADS8361-compatible behavior); if M0 = '1', no action (default).

01 = Update of the entire CONFIG register content enabled.

10 = Reserved for factory test; do not use. Changes may result in false behavior of the device.

11 = If M0 = '0', update of input selection bits C[1:0] only (ADS8361-compatible behavior); if M0 = '1', no action.

Bits[11:10]
PD[1:0]—Power-down control.

These bits control the different power-down modes of the device.

00 = Normal operation (default).

01 = Device is in power-down mode (see the [Power-Down Modes and Reset](#) section for details).

10 = Device is in sleep power-down mode (see the [Power-Down Modes and Reset](#) section for details).

11 = Device is in Auto-sleep power-down mode (see the [Power-Down Modes and Reset](#) section for details).

Bit 9
FE—FIFO enable control.

0 = The internal FIFO is disabled (default).

1 = The internal FIFO is enabled. The depth of the FIFO is controlled by SEQFIFO register bits FD[1:0].

Bit 8
SR—Special read mode control.

0 = Special read mode is disabled (default).

1 = Special read mode is enabled; see [Figure 33](#) and [Figure 36](#) for details.

Bit 7
FC—Full clock mode operation control.

0 = Full-clock mode operation is disabled (default); see [Figure 1](#) for details.

1 = Full-clock mode operation is enabled; see [Figure 2](#) for details.

Bit 6
PDE—Pseudo-differential mode operation enable.

0 = 2 x 2 fully-differential operation (default).

1 = 4 x 2 pseudo-differential operation.

Bit 5
CID—Channel information disable.

0 = The channel information followed by conversion results or register contents are present on SDOx (default).

1 = Conversion data or register content is present on SDOx immediately after the falling edge of RD.

Bit 4
CE—2-bit counter enable (see [Figure 40](#)).

0: The internal counter is disabled (default).

1: The counter value is available prior to the conversion result on SDOx (active only if CID = '0').

Bits[3:0]

A[3:0]—Register access control.

These bits allow reading of the CONFIG register contents and control the access to the remaining registers of the device.

- x000 = Update CONFIG register contents only (default)
- 0001 = Read CONFIG register content on SDOA with next access (see Figure 38).
- x010 = Write to REFDAC1 register with next access (see Figure 38).
- 0011 = Read REFDAC1 register content on SDOA with next access (see Figure 38).
- 0100 = Generate software reset of the device.
- x101 = Write to REFDAC2 register with next access (see Figure 38).
- 0110 = Read REFDAC2 register content on SDOA with next access (see Figure 38).
- x111 = Update CONFIG register contents only.
- 1001 = Write to SEQFIFO register with next access (see Figure 38).
- 1011 = Read SEQFIFO register content on SDOA with next access (see Figure 38).
- 1100 = Write to REFCM register with next access (see Figure 38).
- 1110 = Read REFCM register content on SDOA with next access (see Figure 38).

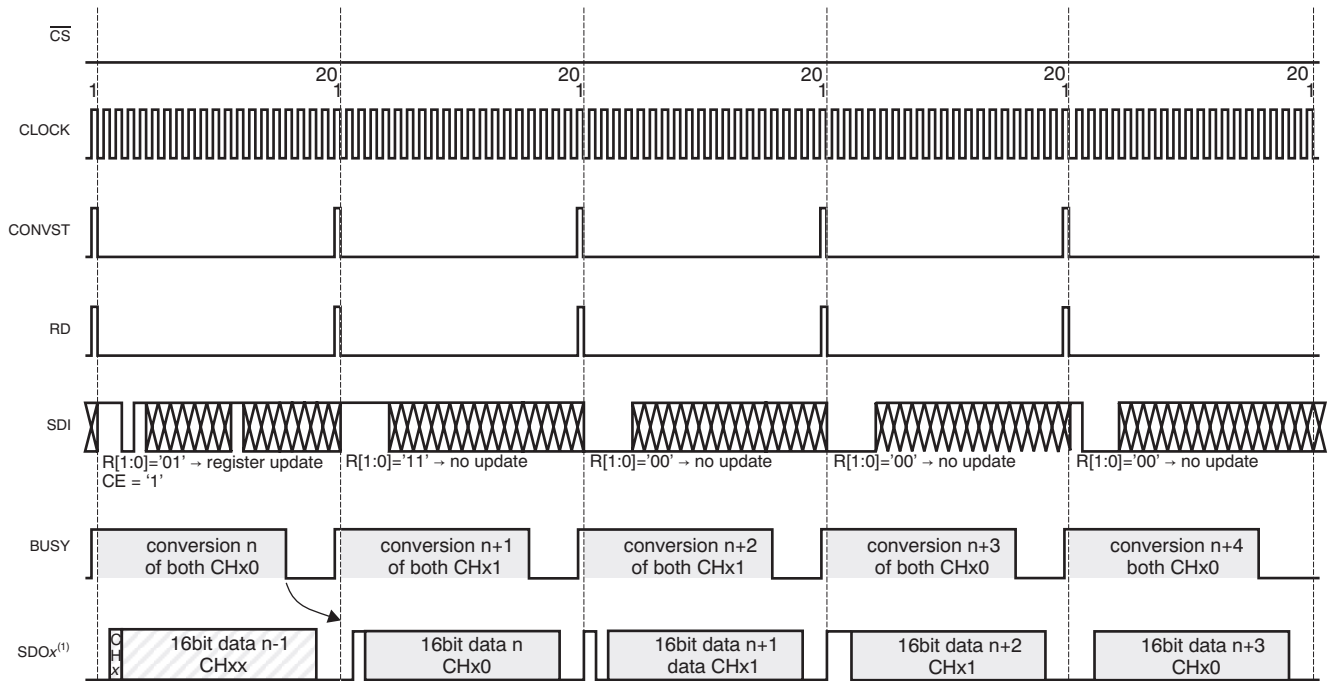

(1) The ADS7263 and ADS7223 output data with the MSB located as the ADS8363 and the last 2 or 4 bits are '0'.

**Figure 40. 2-Bit Counter Feature
(Half-Clock Mode, Manual Channel Control, CID = '0')**

8.6.2 REFDAC1 and REFDAC2 Registers

Two reference DAC registers allow for enabling and setting up the appropriate value for each of the output string DACs that are connected to the REFIO1 and REFIO2 pins.

Figure 41. REFDAC1 Control Register (Default = 07FFh)

15 (MSB)	14	13	12	11	10	9	8	7	6	5	4	3	2	1	0 (LSB)
0	0	0	0	0	RPD	D9	D8	D7	D6	D5	D4	D3	D2	D1	D0

Bits[15:11] Not used; always set to '0'.

Bit 10 RPD—DAC1 power down.

0 = Internal reference path 1 is enabled and the reference voltage is available at the REFIO1 pin.
1 = The internal reference path is disabled (default).

Bits[9:0] **D[9:0]—DAC1 setting bits.**

These bits correspond to the settings of the internal reference DACs (compare REFIO section). The D9 bit is the MSB value of the DAC.
Default value is 3FFh (2.5V nom)

Figure 42. REFDAC2 Control Register (Default = 07FFh)

15 (MSB)	14	13	12	11	10	9	8	7	6	5	4	3	2	1	0 (LSB)
0	0	0	0	0	RPD	D9	D8	D7	D6	D5	D4	D3	D2	D1	D0

Bits[15:11] Not used; always set to '0'.

Bit 10 RPD—DAC2 power down.

0 = Internal reference path 2 is enabled and the reference voltage is available at the REFIO2 pin.
1 = The internal reference path is disabled (default).

Bits[9:0] **D[9:0]—DAC2 setting bits.**

These bits correspond to the settings of the internal reference DACs (compare REFIO section). The D9 bit is the MSB value of the DAC.
Default value is 3FFh (2.5V nom)

8.6.3 Sequencer/FIFO (SEQFIFO) Register

The ADS8363, ADS7363, and ADS7223 feature a programmable sequencer that controls the switching of the ADC input multiplexer in pseudo-differential, automatic channel-selection mode only. When used, a single read pulse allows reading of all stored conversion data. A single CONVST is required to control the conversion of the entire sequence. If the sequencer is used, CONVST and RD must be controlled independently (see [Figure 44](#) and [Figure 45](#)).

Additionally, a programmable FIFO is available on each channel that allows for storing up to four conversion results. Both features are controlled using this register. If FIFO is used, CONVST and RD must be controlled independently. Note that after activation of this feature, the FIFO must be full before being read for the first time.

If the FIFO is full and a new conversion starts, the contents are shifted by one and the oldest result is lost. Only when the sequencer is used are the entire FIFO contents lost (that is, all bits are automatically set to '0'). The FIFO can be used independently from the sequencer. When both are used, the complete sequence must be finished before reading the data out of the FIFO; otherwise, the data may be corrupted.

[Table 9](#) contains details of the data readout requirements depending on the FIFO settings in automatic channel selection mode.

Table 9. Conversion Result Read Out In FIFO Mode

AUTOMATIC CHANNEL SELECTION		
INPUT SIGNAL TYPE	FE = '0'	FE = '1'
Fully-differential input mode	Read cycle length = 1 word One RD pulse required after each conversion	Read cycle length = 2 · FIFO length One RD pulse required for the entire FIFO content
Pseudo-differential input mode	Read cycle length = 1 word One RD pulse required after each conversion or after completing the sequence if S1 = '1' and S0 = '1'	Read cycle length = 2 · sequencer length · FIFO length One RD pulse required for the entire FIFO content

Figure 43. SEQFIFO: Sequencer and FIFO Register (Default = 0000h)⁽¹⁾

15 (MSB)	14	13	12	11	10	9	8	7	6	5	4	3	2	1	0 (LSB)
S1	S0	SL1	SL0	C11	C10	C21	C20	C31	C30	C41	C40	SP1	SP0	FD1	FD0

(1) The sequencer is used in pseudo-differential mode only; this register must be set before setting the REFCM register.

Bits[15:14]	S[1:0]—Sequencer mode selection (see Figure 44) in pseudo-differential mode only. These bits allow for the control of the number of CONVSTs required, and the behavior of the BUSY pin in Sequencer mode. 0x = An individual CONVST is required with BUSY indicating each conversion (default). 10 = A single CONVST is required for the entire sequence with BUSY indicating each conversion (half-clock mode only). 11 = A single CONVST is required for the entire sequence with BUSY remaining high throughout the sequence (half-clock mode only)
Bits[13:12]	SL[1:0] Sequencer length control. These bits control the length of a sequence. Bits [11:6] are only active if SL > '00'. 00 = Do not use; use Mode I or II instead, where M0 = '0' (default). 01 = Sequencer length = 2; C1x (bits[11:10]) and C2x (bits[9:8]) define the actual channel selection. 10 = Sequencer length = 3; C1x (bits[11:10]), C2x (bits[9:8]) and C3x (bits[7:6]) define the actual channel selection. 11 = Sequencer length = 4; C1x (bits[11:10]), C2x (bits[9:8]), C3x (bits[7:6]), and C4x (bits[5:4]) define the actual channel selection.
Bits[11:10]	C1[1:0]—First channel in sequence selection bits.
Bits[9:8]	C2[1:0]—Second channel in sequence selection bits.
Bits[7:6]	C3[1:0]—Third channel in sequence selection bits.
Bits[5:4]	C4[1:0]—Fourth channel in sequence selection bits. Bits [11:4] control the pseudo-differential input multiplexer channel selection in sequencer mode. 00 = CHA0 and CHB0 are selected for the next conversion (default). 01 = CHA1 and CHB1 are selected for the next conversion. 10 = CHA2 and CHB2 are selected for the next conversion. 11 = CHA3 and CHB3 are selected for the next conversion.

Bits[3:2] SP[1:0]—Sequence position bits (read only).
 These bits indicate the setting of the pseudo-differential input multiplexer in sequencer mode.
 00 = Inputs selected using bits C1[1:0] are converted with next rising edge of CONVST (default).
 01 = Inputs selected using bits C2[1:0] are converted with next rising edge of CONVST.
 10 = Inputs selected using bits C3[1:0] are converted with next rising edge of CONVST.
 11 = Inputs selected using bits C4[1:0] are converted with next rising edge of CONVST.

Bits [1:0] FD[1:0]—FIFO depth control (see Figure 45).
 These bits control the depth of the internal FIFO if CONFIG register bit FE = '1'.
 00 = One conversion result per channel is stored in the FIFO for burst read access (default).
 01 = Two conversion results per channel are stored in the FIFO for burst read access.
 10 = Three conversion results per channel are stored in the FIFO for burst read access.
 11 = Four conversion results per channel are stored in the FIFO for burst read access .

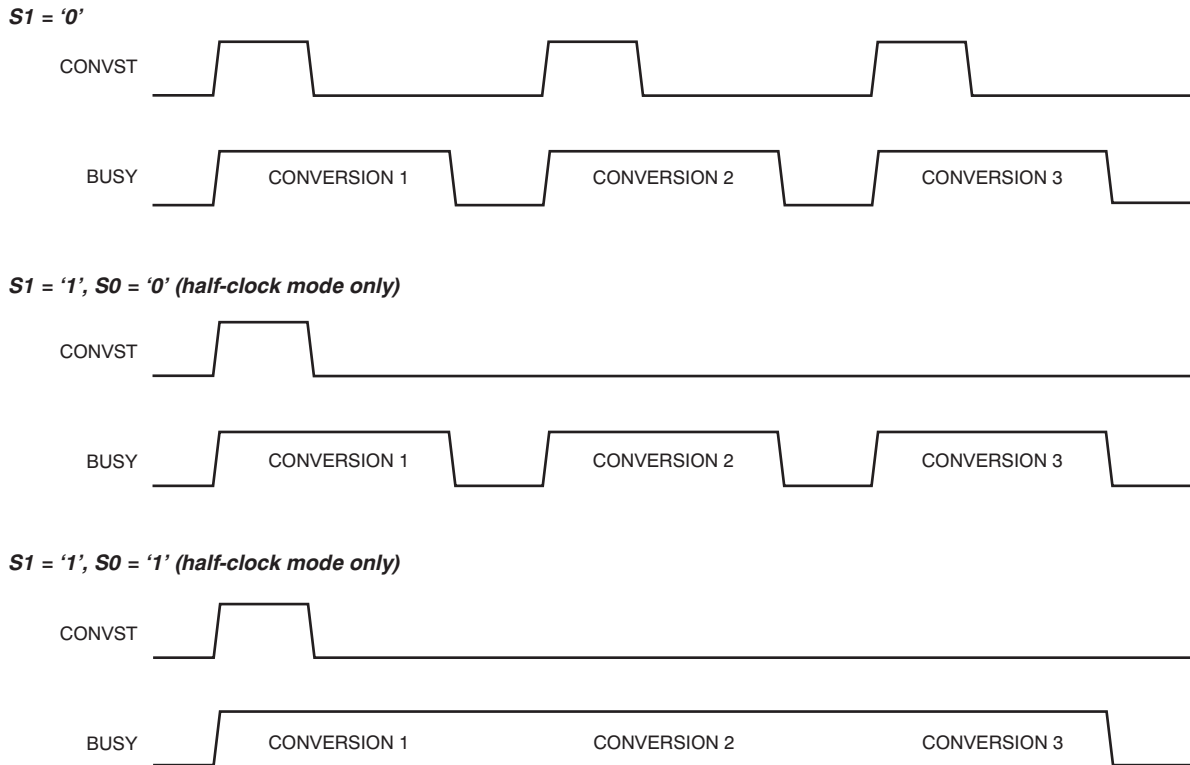
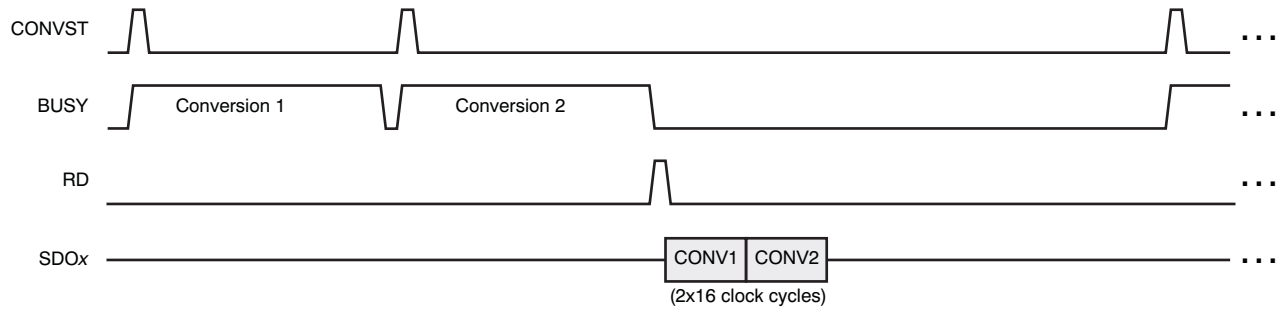

Figure 44. Sequencer Modes

FD[1:0] = '01', SL[1:0] = '00'



FD[1:0] = '01', SL[1:0] = '10'

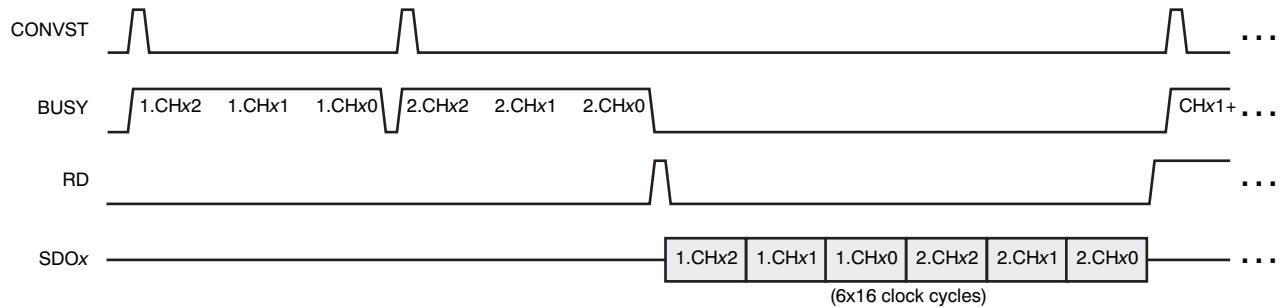

Figure 45. FIFO and Sequencer Operation Example

8.6.4 Reference and Common-Mode Selection (REFCM) Register

To allow flexible adjustment of the common-mode voltage in pseudo-differential mode when simplifying the circuit layout, the ADS8363, ADS7263, and ADS7223 provide this register to assign one of the CMx inputs as a reference for each of the input signals. According to the register settings, the CMx signals are internally connected to the appropriate negative input of each ADC.

Additionally, this register also allows for the flexible assignment of one of the internal reference DAC outputs as a reference for each channel in both fully- and pseudo-differential modes.

Figure 46. REFCM: Reference and Common-Mode Selection Register (Default = 0000h)⁽¹⁾

15 (MSB)	14	13	12	11	10	9	8	7	6	5	4	3	2	1	0 (LSB)
CMB3	CMB2	CMB1	CMB0	CMA3	CMA2	CMA1	CMA0	RB3	RB2	RB1	RB0	RA3	RA2	RA1	RA0

(1) This register must be set after setting the SEQFIFO register.

Bits[15:8]	CMxx—Common-mode source selection bits (per input channel). These bits allow selection of the CMx input pins or the internal reference source as common-mode for pseudo-differential inputs B[3:0] and A[3:0]. The selected signal is connected to the negative input of the corresponding ADC. 0 = external common-mode source through CMx (default). 1 = internal common-mode source = REFIOx, depending on settings of bits Rx[3 :0].
Bit 7	RB3—Internal reference DAC output selection for CHB3 in pseudo-differential mode, or channel CHB1P, CHB1N in fully-differential mode. 0 = internal reference source REFIO1 selected (default). 1 = internal reference source REFIO2 selected.
Bit 6	RB2—Internal reference DAC output selection for CHB2 in pseudo-differential mode only. 0 = internal reference source REFIO1 selected (default). 1 = internal reference source REFIO2 selected.
Bit 5	RB1—Internal reference DAC output selection for CHB1 in pseudo-differential mode only. 0 = internal reference source REFIO1 selected (default). 1 = internal reference source REFIO2 selected.
Bit 4	RB0—Internal reference DAC output selection for CHB0 in pseudo-differential mode, or channel CHB0P, CHB0N in fully-differential mode. 0 = internal reference source REFIO1 selected (default). 1 = internal reference source REFIO2 selected.
Bit 3	RA3—Internal reference DAC output selection for CHA3 in pseudo-differential mode, or channel CHA1P, CHA1N in fully-differential mode. 0 = internal reference source REFIO1 selected (default). 1 = internal reference source REFIO2 selected.
Bit 2	RA2—Internal reference DAC output selection for CHA2 in pseudo-differential mode only. 0 = internal reference source REFIO1 selected (default). 1 = internal reference source REFIO2 selected.
Bit 1	RA1—Internal reference DAC output selection for CHA1 in pseudo-differential mode only. 0 = internal reference source REFIO1 selected (default). 1 = internal reference source REFIO2 selected.
Bit 0	RA0—Internal reference DAC output selection for CHA0 in pseudo-differential mode, or channel CHA0P, CHA0N in fully-differential mode. 0 = internal reference source REFIO1 selected (default). 1 = internal reference source REFIO2 selected.

9 Application and Implementation

NOTE

Information in the following applications sections is not part of the TI component specification, and TI does not warrant its accuracy or completeness. TI's customers are responsible for determining suitability of components for their purposes. Customers should validate and test their design implementation to confirm system functionality.

9.1 Application Information

9.1.1 ADS8361 Compatibility

This section describes the differences between the ADS8361 and the ADS8363, ADS7263, and ADS7223 family of devices in default mode without changing the internal register settings (that are not available on the ADS8361).

9.1.1.1 Pinout

The ADS8363, ADS7263, and ADS7223 family is pin-compatible to ADS8361IRHB. However, there are some differences that must be considered when migrating from an ADS8361-based design, as summarized in [Table 10](#).

Table 10. Pinout Differences Between the ADS8363, ADS7263, and ADS7223 and the ADS8361

PIN NO.	PIN NAME		IMPACT
	ADS8361	ADS8363, ADS7263, and ADS7223	
9	REFIN	REFIO1	If external reference is used, see the Internal Reference section for details. If internal reference is used, REFIO1 must be enabled using the RPD bit in the DAC1 register.
10	REFOUT	REFIO2	Because REFIO2 is disabled by default, no adjustment is required.
11	NC	RGND	If external reference is used, no changes required. If REFIO1 is enabled, this pin must be tied to the analog ground plane with a dedicated via. Furthermore, a 22- μ F ceramic capacitor must be used between this pin and pin 9.
18	A0	SDI	See the SDI versus A0 section for details.
29	NC	AVDD	This pin must be connected to the analog supply and decoupled with a 1- μ F capacitor to ensure proper functionality of the ADS8363, ADS7263, and ADS7223 family.
30	NC	AGND	This pin must be connected to the analog ground plane to ensure proper functionality of the ADS8363, ADS7263, and ADS7223 family.
31	NC	CMA	In default mode of the ADS8363 family; no changes required.
32	NC	CMB	In default mode of the ADS8363 family; no changes required.

9.1.1.2 SDI versus A0

Pin 18 (SDI) of the ADS8363, ADS7263, and ADS7223 is used to update the internal registers, whereas on the ADS8361, pin 18 (A0) is used in conjunction with M0 to select the input channel.

If, in an existing design, the ADS8361 is used in two-channel mode (M0 = '0') and the status of the A0 pin is unchanged within the first four clock cycles after issuing a conversion start (rising edge of CONVST), the ADS8363, ADS7263, and ADS7223 act similarly to the ADS8361 and convert either channels CHx0 (if SDI is held low during the entire period) or channels CHx1 (if SDI is held high during the entire period). [Figure 34](#) illustrates the behavior of the ADS8363, ADS7263, and ADS7223 in such a situation.

The ADS8363, ADS7263, and ADS7223 can be also be used to replace the ADS8361 when run in four-channel mode (M0 = '1'). In this case, the A0 pin is held static (high or low), which is also required in for the SDI pin to prevent accidental update of the SDI register.

In both cases described previously, the additional features of the ADS8363, ADS7263, and ADS7223 (pseudo-differential input mode, programmable reference voltage output, and the various power-down modes) cannot be accessed, but the hardware and software remain backward-compatible to the ADS8361.

9.1.1.3 Internal Reference

The internal reference of the ADS8361 delivers 2.5 V (typ) after power up, and the reference output of the ADS8363, ADS7263, and ADS7223 is powered down by default. In this case, the unbuffered reference input has a code-dependent input impedance, and the ADS8361 offers a high-impedance (buffered) reference input. If an existing ADS8361-based design uses the internal reference of the device and relies on an external resistor divider to adjust the input voltage range of the ADC, migration to the ADS8363 family requires one of the following conditions:

- A software change to setup internal reference DAC1 properly through SDI when removing the external resistors; or
- An additional external buffer between the resistor divider and the required 22 µF (min) capacitor on the REFIO1 input.

In the latter case, when the capacitor stabilizes the reference voltage during the entire conversion, the buffer must recharge the capacitor by providing an average current only; thus, the required minimum bandwidth of the buffer can be calculated using [Equation 4](#):

$$f_{-3dB} = \frac{\ln(2) \times 2}{2\pi \times 20t_{CLK}} \quad (4)$$

The buffer must also be capable of driving the 22-µF load when maintaining stability.

9.1.1.4 Timing

In half-clock mode (default), the ADS8363, ADS7263, and ADS7223 family of devices provides the conversion delay after completion of the conversion (see [Figure 1](#)), and the ADS8361 offers the conversion result during the conversion process.

9.1.1.5 RD

The ADS8363, ADS7263, and ADS7223 output the first bit with the falling edge of the RD input. The ADS8361 starts the data transfer with the first falling edge of the clock if RD is high.

If the ADS8363, ADS7263, and ADS7223 operate with half-clock timing in modes II and IV, the RD input must not be held high longer than one clock cycle to ensure proper function of the data output SDOA.

9.1.1.6 CONVST

If the ADS8363, ADS7263, and ADS7223 operate with half-clock timing in modes II and IV, the CONVST input must not be held high longer than one clock cycle to ensure proper function of the device.

9.1.2 Minimum Configuration Example

An example of a minimum configuration for the ADS8363, ADS7263, and ADS7223 is illustrated in [Figure 47](#). In this case, the device is used in dual-channel, fully-differential input mode with a four-wire digital interface connected to the controller device and with default settings of the device after power up. Because the internal reference is disabled at power up (to prevent driving against an external reference if used), an external reference source is shown in this example. To allow the use of the internal reference, the SDI input must be connected to the controller, allowing access to the REFDAC registers. The corresponding timing diagram including the timing requirements are described in [Figure 48](#) and the [Timing Characteristics](#) table.

The input signal for the amplifiers must fulfill the common-mode voltage requirements of the device in this configuration. The actual values of the resistors and capacitors depend on the bandwidth and performance requirements of the application.

Those values can be calculated using [Equation 5](#):

$$f_{\text{FILTER}} = \frac{\ln(2)(n + 1)}{2\pi 2RC}$$

where

- $n = 16$ as the resolution of the ADS8363 ($n = 14$ for ADS7263, $n = 12$ for ADS7223) (5)

As a good trade-off between required minimum driver bandwidth and the capacitor value, a capacitor value of at least 1 nF is recommended.

Keeping the acquisition time in mind, the resistor value can be calculated as shown in [Equation 6](#) for each of the series resistors:

$$R = \frac{t_{\text{ACQ}}}{\ln(2)(n + 1)2C}$$

where

- $n =$ the device resolution (6)

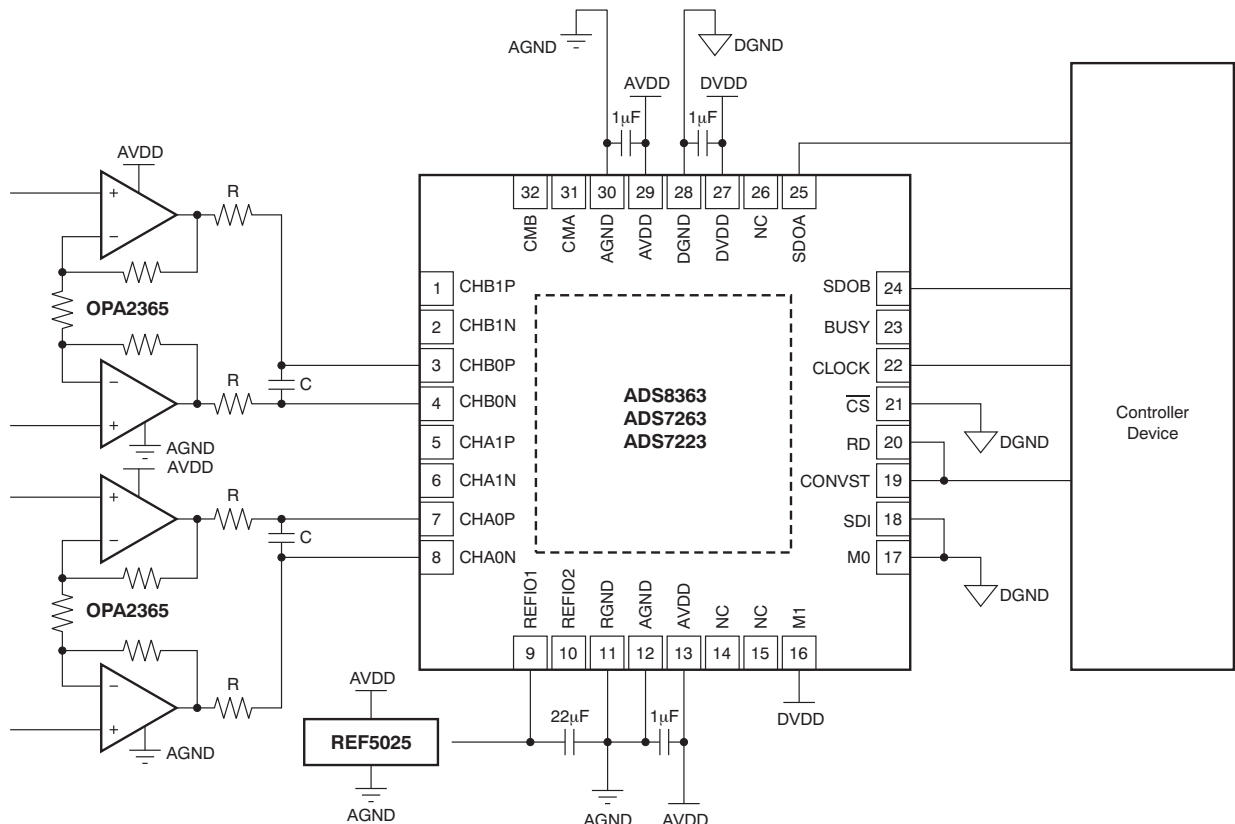

Figure 47. Four-Wire Application Configuration

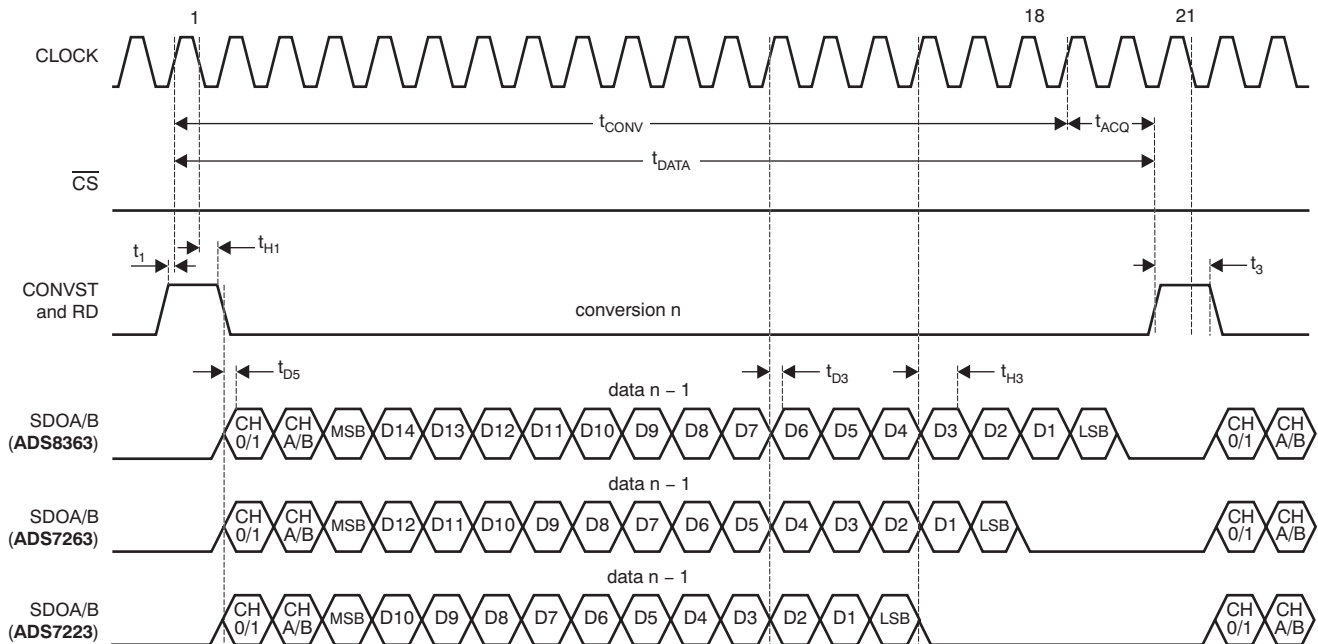

Figure 48. Four-Wire Application Timing (Half-Clock Mode)

10 Power Supply Recommendations

The ADS8363 and ADS7263 have two separate supplies: the DVDD pin for the buffers of the digital interface and the AVDD pin for all the remaining circuits.

DVDD can range from 2.3 V to 5.5 V, allowing the ADC to easily interface with processors and controllers. To limit the injection of noise energy from external digital circuitry, DVDD must be properly filtered. A bypass capacitor of 1 μ F must be placed between the DVDD pin and the digital ground plane.

AVDD supplies the internal analog circuitry. For optimum performance, a linear regulator (for example, the UA7805 family) is recommended to generate the analog supply voltage in the range of 2.7 V to 5.5 V for the ADC and the necessary analog front-end.

Bypass capacitors of 1 μ F must be connected to the analog ground plane such that the current is allowed to flow through the pad of these capacitors (that is, the vias must be placed on the opposite side of the connection between the capacitor and the power-supply pin of the ADC).

11 Layout

11.1 Layout Guidelines

For optimum performance, care must be taken with the physical layout of the ADS8363, ADS7263, and ADS7223 circuitry, particularly if the device is used at the maximum throughput rate. In this case, a fixed phase relationship is recommended between CLOCK and CONVST.

Additionally, the high-performance SAR architecture is sensitive to glitches or sudden changes on the power supply, reference, ground connections, and digital inputs that occur just before latching the output of the internal analog comparator. Therefore, during an operation of an n -bit SAR converter, there are n windows in which large external transient voltages (glitches) can affect the conversion result. Such glitches can originate from switching power supplies, nearby digital logic, or high-power devices. The degree of impact depends on the reference voltage, layout, and the actual timing of the external event.

With this possibility in mind, power to the device must be clean and well-bypassed. A 1- μ F ceramic bypass capacitor must be placed at each supply pin (connected to the corresponding ground pin) as close to the device as possible.

If the reference voltage is external, the operational amplifier must be able to drive the 22- μ F capacitor without oscillation. A series resistor between the driver output and the capacitor may be required. To minimize any code-dependent voltage drop on this path, a small value must be used for this resistor (10 Ω max). TI's REF50xx family is able to directly drive such a capacitive load.

11.1.1 Grounding

The AGND, RGND, and DGND pins must be connected to a clean ground reference. All connections must be kept as short as possible to minimize the inductance of these paths. Using vias connecting the pads directly to the ground plane is recommended. In designs without ground planes, the ground trace must be kept as wide as possible. Avoid connections that are close to the grounding point of a microcontroller or digital signal processor.

Depending on the circuit density of the board, placement of the analog and digital components, and the related current loops, a single solid ground plane for the entire printed circuit board (PCB) or a dedicated analog ground area can be used. In case of a separated analog ground area, ensure a low-impedance connection between the analog and digital ground of the ADC by placing a bridge underneath (or next) to the ADC (see Figure 49). Otherwise, even short undershoots on the digital interface with a value of less than -300 mV can lead to conduction of ESD diodes, causing current flow through the substrate and degrading the analog performance.

During the layout of the PCB, care must be taken to avoid any return currents crossing any sensitive analog areas or signals. No signal must exceed the limit of -300 mV with respect to the corresponding (AGND or DGND) ground plane.

11.1.2 Digital Interface

To further optimize performance of the device, a series resistor of between 10 Ω to 100 Ω can be used on each digital pin of the device. In this way, the slew rate of the input and output signals is reduced, limiting the noise injection from the digital interface.

11.2 Layout Example

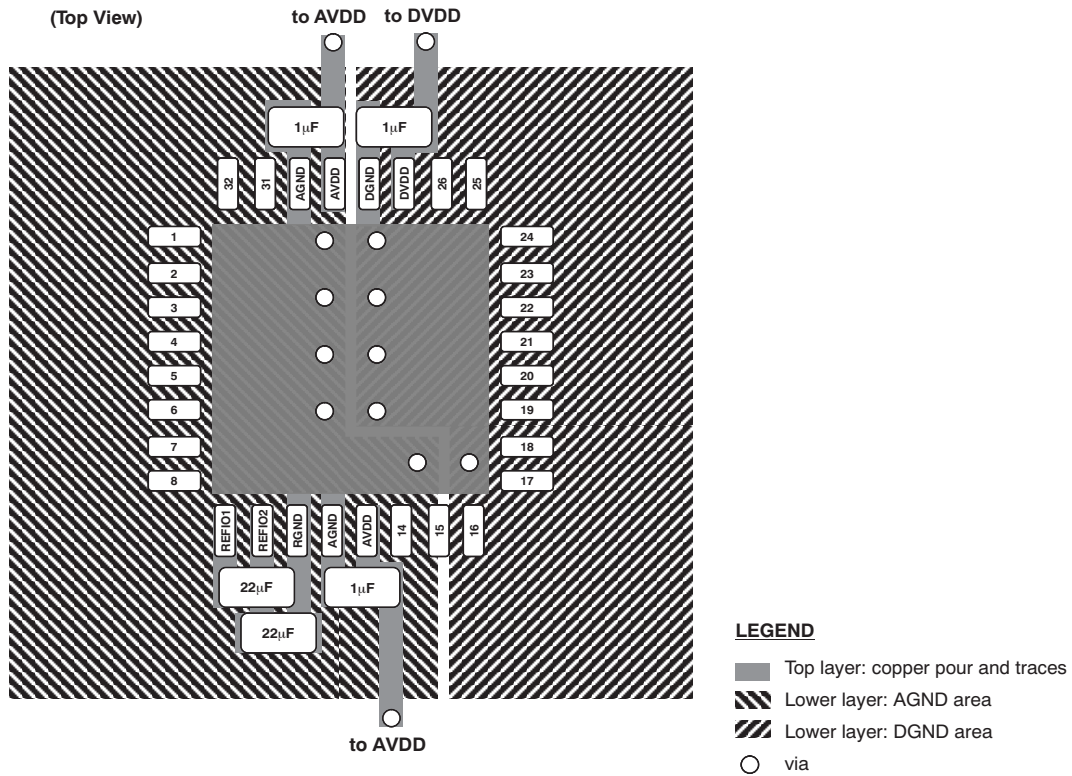

Figure 49. Optimized Layout Recommendation

12 Device and Documentation Support

12.1 Documentation Support

12.1.1 Related Documentation

For related documentation see the following:

- [REF60xx High-Precision Voltage Reference With Integrated ADC Drive Buffer](#)
- [REF50xx Low-Noise, Very Low Drift, Precision Voltage Reference](#)
- [μA78xx Fixed Positive Voltage Regulators](#)

12.2 Related Links

[Table 11](#) lists quick access links. Categories include technical documents, support and community resources, tools and software, and quick access to sample or buy.

Table 11. Related Links

PARTS	PRODUCT FOLDER	SAMPLE & BUY	TECHNICAL DOCUMENTS	TOOLS & SOFTWARE	SUPPORT & COMMUNITY
ADS8363	Click here	Click here	Click here	Click here	Click here
ADS7263	Click here	Click here	Click here	Click here	Click here
ADS7223	Click here	Click here	Click here	Click here	Click here

12.3 Receiving Notification of Documentation Updates

To receive notification of documentation updates, navigate to the device product folder on ti.com. In the upper right corner, click on *Alert me* to register and receive a weekly digest of any product information that has changed. For change details, review the revision history included in any revised document.

12.4 Community Resources

The following links connect to TI community resources. Linked contents are provided "AS IS" by the respective contributors. They do not constitute TI specifications and do not necessarily reflect TI's views; see TI's [Terms of Use](#).

TI E2E™ Online Community *TI's Engineer-to-Engineer (E2E) Community*. Created to foster collaboration among engineers. At e2e.ti.com, you can ask questions, share knowledge, explore ideas and help solve problems with fellow engineers.

Design Support *TI's Design Support* Quickly find helpful E2E forums along with design support tools and contact information for technical support.

12.5 Trademarks

E2E is a trademark of Texas Instruments.
All other trademarks are the property of their respective owners.

12.6 Electrostatic Discharge Caution



This integrated circuit can be damaged by ESD. Texas Instruments recommends that all integrated circuits be handled with appropriate precautions. Failure to observe proper handling and installation procedures can cause damage.

ESD damage can range from subtle performance degradation to complete device failure. Precision integrated circuits may be more susceptible to damage because very small parametric changes could cause the device not to meet its published specifications.

12.7 Glossary

[SLYZ022](#) — *TI Glossary*.

This glossary lists and explains terms, acronyms, and definitions.

13 Mechanical, Packaging, and Orderable Information

The following pages include mechanical, packaging, and orderable information. This information is the most current data available for the designated devices. This data is subject to change without notice and revision of this document. For browser-based versions of this data sheet, refer to the left-hand navigation.

PACKAGING INFORMATION

Orderable Device	Status (1)	Package Type	Package Drawing	Pins	Package Qty	Eco Plan (2)	Lead finish/ Ball material (6)	MSL Peak Temp (3)	Op Temp (°C)	Device Marking (4/5)	Samples
ADS7223SRHBR	ACTIVE	VQFN	RHB	32	3000	RoHS & Green	NIPDAU	Level-3-260C-168 HR	-40 to 125	ADS 7223	Samples
ADS7223SRHBT	ACTIVE	VQFN	RHB	32	250	RoHS & Green	NIPDAU	Level-3-260C-168 HR	-40 to 125	ADS 7223	Samples
ADS7263SRHBR	ACTIVE	VQFN	RHB	32	3000	RoHS & Green	NIPDAU	Level-3-260C-168 HR	-40 to 125	ADS 7263	Samples
ADS7263SRHBT	ACTIVE	VQFN	RHB	32	250	RoHS & Green	NIPDAU	Level-3-260C-168 HR	-40 to 125	ADS 7263	Samples
ADS8363SRHBR	ACTIVE	VQFN	RHB	32	3000	RoHS & Green	NIPDAU	Level-3-260C-168 HR	-40 to 125	ADS8363	Samples
ADS8363SRHBT	ACTIVE	VQFN	RHB	32	250	RoHS & Green	NIPDAU	Level-3-260C-168 HR	-40 to 125	ADS8363	Samples

(1) The marketing status values are defined as follows:

ACTIVE: Product device recommended for new designs.

LIFEBUY: TI has announced that the device will be discontinued, and a lifetime-buy period is in effect.

NRND: Not recommended for new designs. Device is in production to support existing customers, but TI does not recommend using this part in a new design.

PREVIEW: Device has been announced but is not in production. Samples may or may not be available.

OBSOLETE: TI has discontinued the production of the device.

(2) **RoHS:** TI defines "RoHS" to mean semiconductor products that are compliant with the current EU RoHS requirements for all 10 RoHS substances, including the requirement that RoHS substance do not exceed 0.1% by weight in homogeneous materials. Where designed to be soldered at high temperatures, "RoHS" products are suitable for use in specified lead-free processes. TI may reference these types of products as "Pb-Free".

RoHS Exempt: TI defines "RoHS Exempt" to mean products that contain lead but are compliant with EU RoHS pursuant to a specific EU RoHS exemption.

Green: TI defines "Green" to mean the content of Chlorine (Cl) and Bromine (Br) based flame retardants meet JS709B low halogen requirements of <=1000ppm threshold. Antimony trioxide based flame retardants must also meet the <=1000ppm threshold requirement.

(3) MSL, Peak Temp. - The Moisture Sensitivity Level rating according to the JEDEC industry standard classifications, and peak solder temperature.

(4) There may be additional marking, which relates to the logo, the lot trace code information, or the environmental category on the device.

(5) Multiple Device Markings will be inside parentheses. Only one Device Marking contained in parentheses and separated by a "~" will appear on a device. If a line is indented then it is a continuation of the previous line and the two combined represent the entire Device Marking for that device.

⁽⁶⁾ Lead finish/Ball material - Orderable Devices may have multiple material finish options. Finish options are separated by a vertical ruled line. Lead finish/Ball material values may wrap to two lines if the finish value exceeds the maximum column width.

Important Information and Disclaimer:The information provided on this page represents TI's knowledge and belief as of the date that it is provided. TI bases its knowledge and belief on information provided by third parties, and makes no representation or warranty as to the accuracy of such information. Efforts are underway to better integrate information from third parties. TI has taken and continues to take reasonable steps to provide representative and accurate information but may not have conducted destructive testing or chemical analysis on incoming materials and chemicals. TI and TI suppliers consider certain information to be proprietary, and thus CAS numbers and other limited information may not be available for release.

In no event shall TI's liability arising out of such information exceed the total purchase price of the TI part(s) at issue in this document sold by TI to Customer on an annual basis.

TAPE AND REEL INFORMATION



QUADRANT ASSIGNMENTS FOR PIN 1 ORIENTATION IN TAPE



*All dimensions are nominal

Device	Package Type	Package Drawing	Pins	SPQ	Reel Diameter (mm)	Reel Width W1 (mm)	A0 (mm)	B0 (mm)	K0 (mm)	P1 (mm)	W (mm)	Pin1 Quadrant
ADS7223SRHBR	VQFN	RHB	32	3000	330.0	12.4	5.3	5.3	1.5	8.0	12.0	Q2
ADS7223SRHBT	VQFN	RHB	32	250	180.0	12.4	5.3	5.3	1.5	8.0	12.0	Q2
ADS7263SRHBR	VQFN	RHB	32	3000	330.0	12.4	5.3	5.3	1.5	8.0	12.0	Q2
ADS7263SRHBT	VQFN	RHB	32	250	180.0	12.4	5.3	5.3	1.5	8.0	12.0	Q2
ADS8363SRHBR	VQFN	RHB	32	3000	330.0	12.4	5.3	5.3	1.5	8.0	12.0	Q2
ADS8363SRHBT	VQFN	RHB	32	250	180.0	12.4	5.3	5.3	1.5	8.0	12.0	Q2

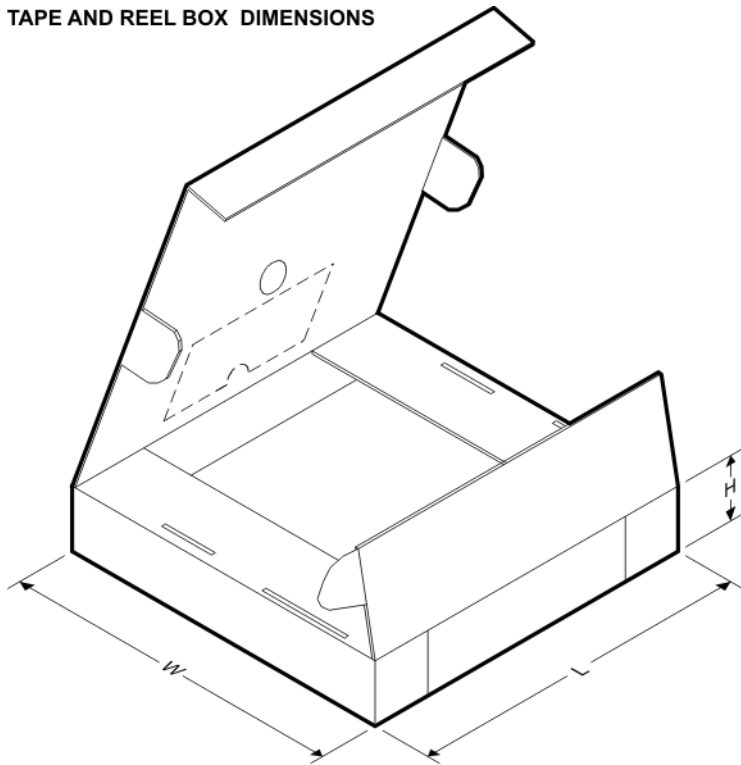
TAPE AND REEL BOX DIMENSIONS

*All dimensions are nominal

Device	Package Type	Package Drawing	Pins	SPQ	Length (mm)	Width (mm)	Height (mm)
ADS7223SRHBR	VQFN	RHB	32	3000	367.0	367.0	35.0
ADS7223SRHBT	VQFN	RHB	32	250	210.0	185.0	35.0
ADS7263SRHBR	VQFN	RHB	32	3000	367.0	367.0	35.0
ADS7263SRHBT	VQFN	RHB	32	250	210.0	185.0	35.0
ADS8363SRHBR	VQFN	RHB	32	3000	367.0	367.0	35.0
ADS8363SRHBT	VQFN	RHB	32	250	210.0	185.0	35.0

GENERIC PACKAGE VIEW

RHB 32

VQFN - 1 mm max height

5 x 5, 0.5 mm pitch

PLASTIC QUAD FLATPACK - NO LEAD

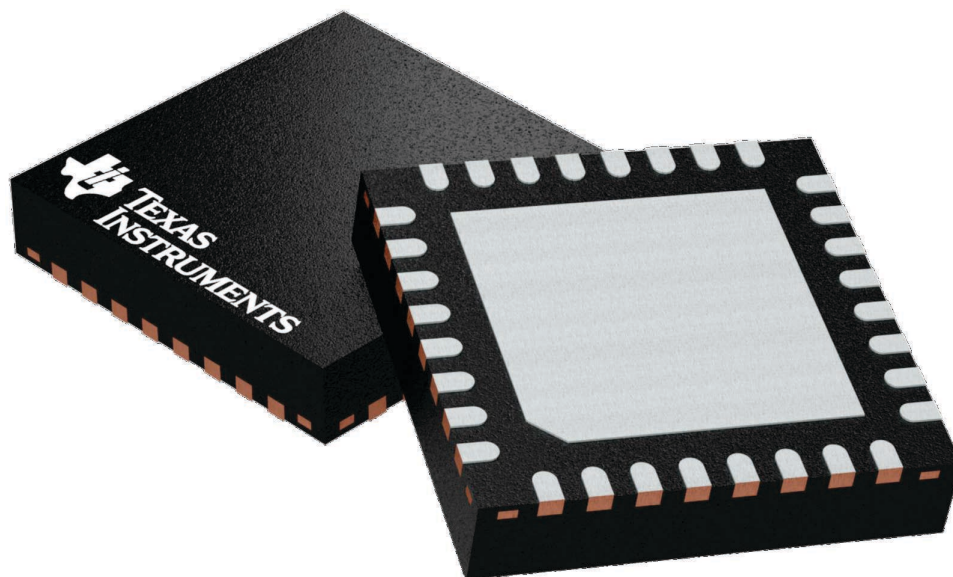

Images above are just a representation of the package family, actual package may vary.
Refer to the product data sheet for package details.

4224745/A

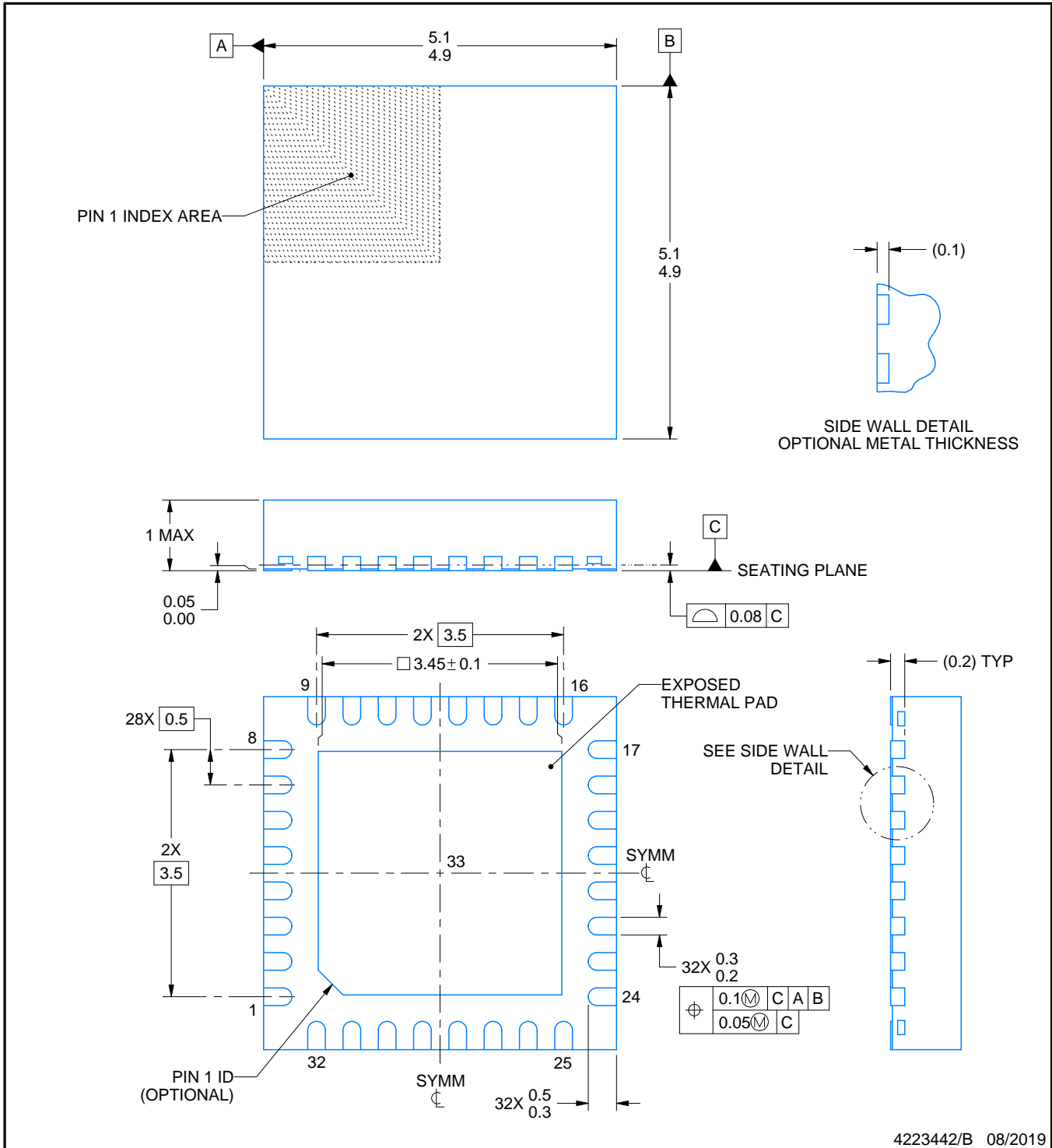

4223442/B 08/2019

NOTES:

1. All linear dimensions are in millimeters. Any dimensions in parenthesis are for reference only. Dimensioning and tolerancing per ASME Y14.5M.
2. This drawing is subject to change without notice.
3. The package thermal pad must be soldered to the printed circuit board for thermal and mechanical performance.

EXAMPLE BOARD LAYOUT

RHB0032E

VQFN - 1 mm max height

PLASTIC QUAD FLATPACK - NO LEAD

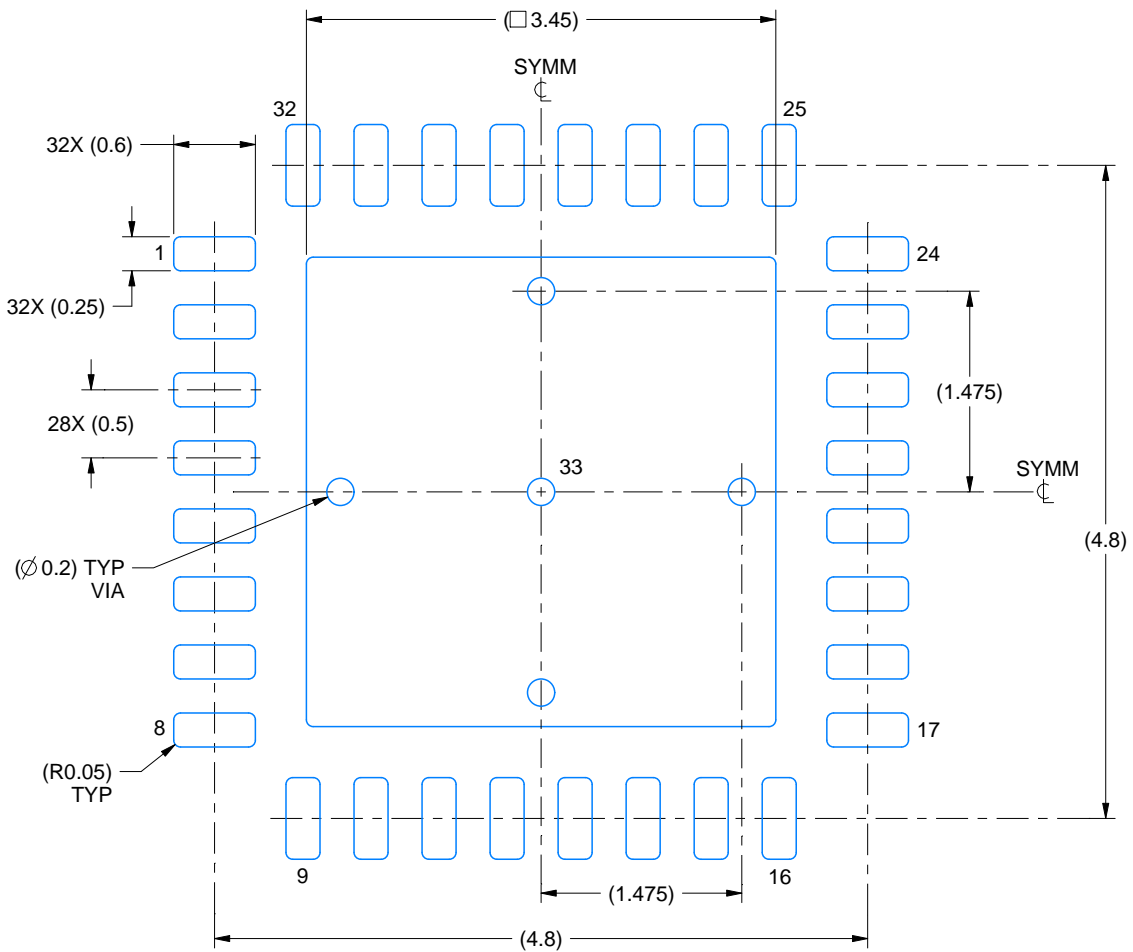

LAND PATTERN EXAMPLE
SCALE:18X

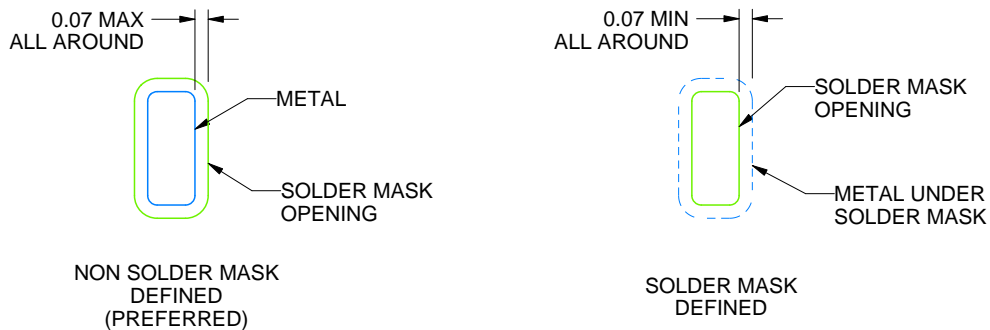

SOLDER MASK DETAILS

4223442/B 08/2019

NOTES: (continued)

- This package is designed to be soldered to a thermal pad on the board. For more information, see Texas Instruments literature number SLUA271 (www.ti.com/lit/sluea271).
- Vias are optional depending on application, refer to device data sheet. If any vias are implemented, refer to their locations shown on this view. It is recommended that vias under paste be filled, plugged or tented.

EXAMPLE STENCIL DESIGN

RHB0032E

VQFN - 1 mm max height

PLASTIC QUAD FLATPACK - NO LEAD

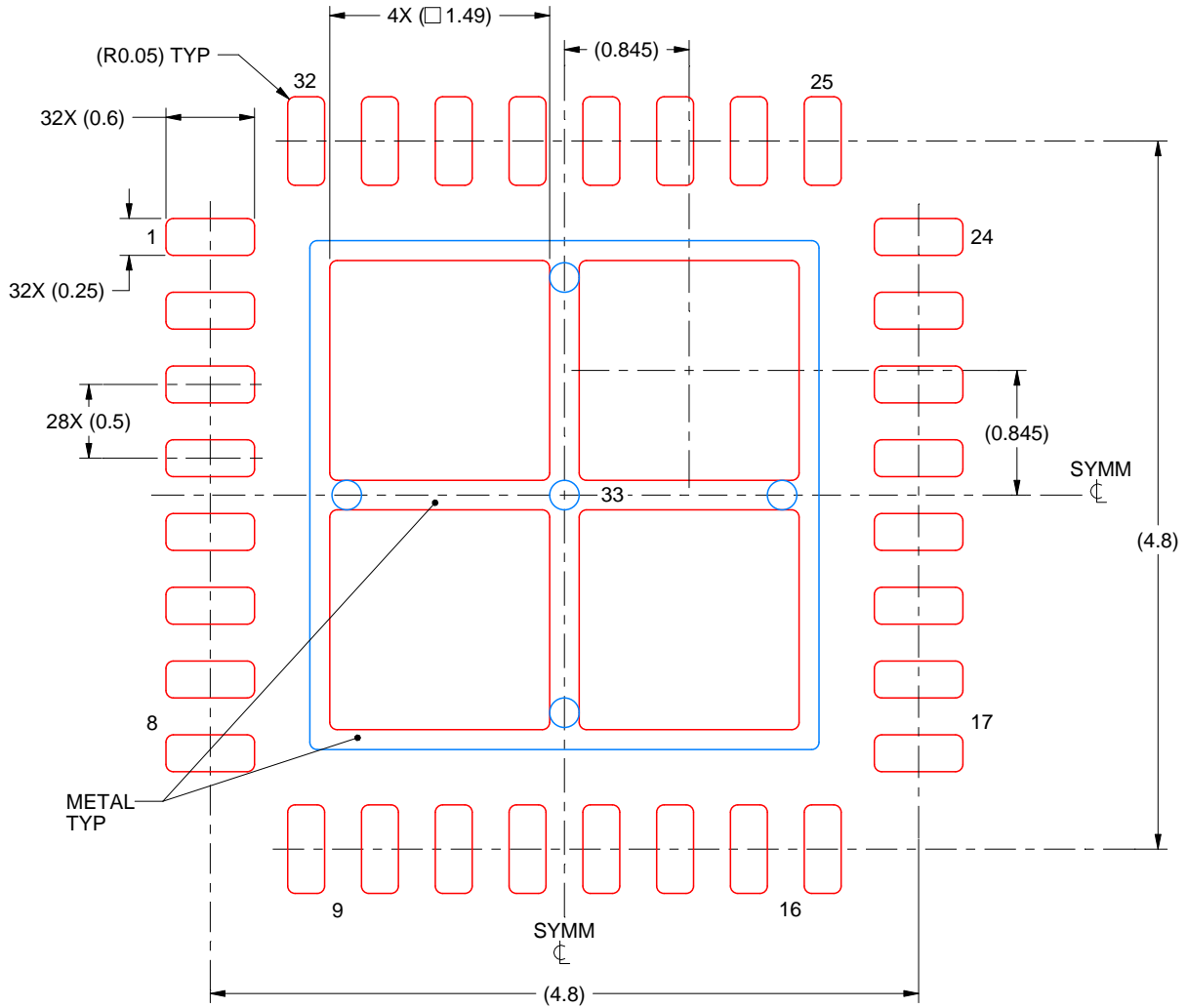

SOLDER PASTE EXAMPLE
 BASED ON 0.125 mm THICK STENCIL

EXPOSED PAD 33:
 75% PRINTED SOLDER COVERAGE BY AREA UNDER PACKAGE
 SCALE:20X

4223442/B 08/2019

NOTES: (continued)

6. Laser cutting apertures with trapezoidal walls and rounded corners may offer better paste release. IPC-7525 may have alternate design recommendations.

IMPORTANT NOTICE AND DISCLAIMER

TI PROVIDES TECHNICAL AND RELIABILITY DATA (INCLUDING DATASHEETS), DESIGN RESOURCES (INCLUDING REFERENCE DESIGNS), APPLICATION OR OTHER DESIGN ADVICE, WEB TOOLS, SAFETY INFORMATION, AND OTHER RESOURCES "AS IS" AND WITH ALL FAULTS, AND DISCLAIMS ALL WARRANTIES, EXPRESS AND IMPLIED, INCLUDING WITHOUT LIMITATION ANY IMPLIED WARRANTIES OF MERCHANTABILITY, FITNESS FOR A PARTICULAR PURPOSE OR NON-INFRINGEMENT OF THIRD PARTY INTELLECTUAL PROPERTY RIGHTS.

These resources are intended for skilled developers designing with TI products. You are solely responsible for (1) selecting the appropriate TI products for your application, (2) designing, validating and testing your application, and (3) ensuring your application meets applicable standards, and any other safety, security, or other requirements. These resources are subject to change without notice. TI grants you permission to use these resources only for development of an application that uses the TI products described in the resource. Other reproduction and display of these resources is prohibited. No license is granted to any other TI intellectual property right or to any third party intellectual property right. TI disclaims responsibility for, and you will fully indemnify TI and its representatives against, any claims, damages, costs, losses, and liabilities arising out of your use of these resources.

TI's products are provided subject to TI's Terms of Sale (www.ti.com/legal/termsofsale.html) or other applicable terms available either on ti.com or provided in conjunction with such TI products. TI's provision of these resources does not expand or otherwise alter TI's applicable warranties or warranty disclaimers for TI products.

Mailing Address: Texas Instruments, Post Office Box 655303, Dallas, Texas 75265
Copyright © 2020, Texas Instruments Incorporated

Looking for pricing, stock, or lifecycle information?

Click below to explore more details on WIN SOURCE:

 [View ADS8363SRHBR](#) on WIN SOURCE

 [Texas Instruments](#) Information

Optimize Your Supply Chain with WIN SOURCE Solutions

-  Global Sourcing Solution
-  Obsolete Management
-  Cost Control Management
-  Shortage Management
-  Alternative Solution
-  Excess Inventory Management