

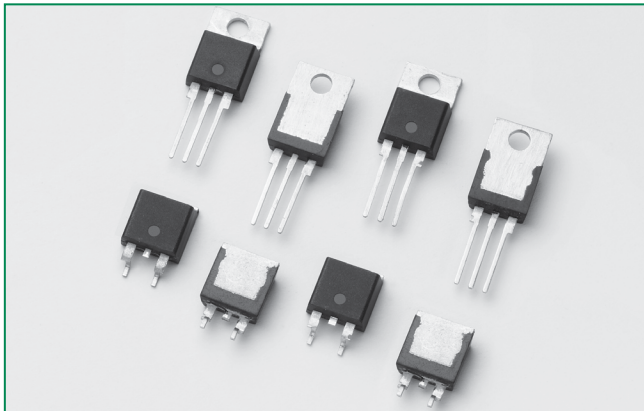

**THE DATASHEET OF
S8025R**



Sxx20x & Sxx25x Series



Description

Excellent unidirectional switches for phase control applications such as heating and motor speed controls. Standard phase control SCRs are triggered with few milliamperes of current at less than 1.5V potential.

Features & Benefits

- RoHS-compliant
- Glass – passivated junctions
- Voltage capability up to 1000 V
- Surge capability up to 350 A
- Available in isolated TO-220, non-isolated TO-220 and TO-263 packages.

Agency Approval

| Agency | Agency File Number |
|--------|--------------------|
| | E71639* |

* - L Package Only

Applications

Typical applications are AC solid-state switches, industrial power tools, exercise equipment, white goods and commercial appliances.

Internally constructed isolated packages are offered for ease of heat sinking with highest isolation voltage.

Main Features

| Symbol | Value | Unit |
|-------------------|-------------|------|
| $I_{T(RMS)}$ | 20 & 25 | A |
| V_{DRM}/V_{RRM} | 400 to 1000 | V |
| I_{GT} | 30 to 35 | mA |

Schematic Symbol

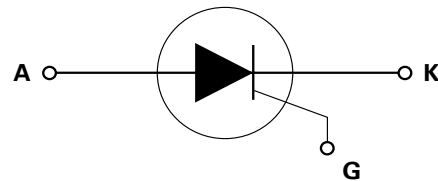

Additional Information



Datasheet



Resources



Samples

Absolute Maximum Ratings – 20A SCR

| Symbol | Parameter | Test Conditions | Value | Unit |
|--------------|---|--|------------|------------------------|
| $I_{T(RMS)}$ | RMS on-state current | $T_c = 80^\circ\text{C}$ | 20 | A |
| $I_{T(AV)}$ | Average on-state current | Sxx20x & Sxx20L $T_c = 80^\circ\text{C}$ | 12.8 | A |
| I_{TSM} | Peak non-repetitive surge current | single half cycle; $f = 50\text{Hz}$; $T_j(\text{initial}) = 25^\circ\text{C}$ | 255 | A |
| | | single half cycle; $f = 60\text{Hz}$; $T_j(\text{initial}) = 25^\circ\text{C}$ | 300 | |
| I^2t | I^2t Value for fusing | $t_p = 8.3 \text{ ms}$ | 374 | A^2s |
| di/dt | Critical rate of rise of on-state current | $f = 60\text{Hz}$; $T_j = 125^\circ\text{C}$ | 125 | $\text{A}/\mu\text{s}$ |
| I_{GM} | Peak gate current | $T_j = 125^\circ\text{C}$ | 3 | A |
| $P_{G(AV)}$ | Average gate power dissipation | $T_j = 125^\circ\text{C}$ | 0.6 | W |
| T_{stg} | Storage temperature range | | -40 to 150 | $^\circ\text{C}$ |
| T_j | Operating junction temperature range | | -40 to 125 | $^\circ\text{C}$ |

Absolute Maximum Ratings — 25A SCR

| Symbol | Parameter | Test Conditions | Value | Unit |
|--------------|---|--|------------|------------------------|
| $I_{T(RMS)}$ | RMS on-state current | Sxx25L: $T_C = 75^\circ\text{C}$ | 25 | A |
| | | Sxx25R/Sxx25N: $T_C = 100^\circ\text{C}$ | | |
| $I_{T(AV)}$ | Average on-state current | Sxx25L $T_C = 75^\circ\text{C}$ | 16 | A |
| | | Sxx25R/Sxx25N $T_C = 100^\circ\text{C}$ | | |
| I_{TSM} | Peak non-repetitive surge current | single half cycle; $f = 50\text{Hz}$; T_J (initial) = 25°C | 300 | A |
| | | single half cycle; $f = 60\text{Hz}$; T_J (initial) = 25°C | 350 | |
| I^2t | I^2t Value for fusing | $t_p = 8.3 \text{ ms}$ | 510 | A^2s |
| di/dt | Critical rate of rise of on-state current | $f = 60\text{Hz}$; $T_J = 125^\circ\text{C}$ | 150 | $\text{A}/\mu\text{s}$ |
| I_{GM} | Peak gate current | $T_J = 125^\circ\text{C}$ | 3.5 | A |
| $P_{G(AV)}$ | Average gate power dissipation | $T_J = 125^\circ\text{C}$ | 0.8 | W |
| T_{stg} | Storage temperature range | | -40 to 150 | $^\circ\text{C}$ |
| T_J | Operating junction temperature range | | -40 to 125 | $^\circ\text{C}$ |

Electrical Characteristics ($T_J = 25^\circ\text{C}$, unless otherwise specified)

| Symbol | Test Conditions | | | Value | | Unit |
|----------|--|-------|------|--------|--------|------------------|
| | | | | Sxx20L | Sxx25x | |
| I_{GT} | $V_D = 12\text{V}$ $R_L = 30 \Omega$ | - | MAX. | 30 | 35 | mA |
| | | - | MIN. | 1 | 1 | |
| V_{GT} | $V_D = 12\text{V}$ $R_L = 30 \Omega$ | - | MAX. | 1.5 | | V |
| dv/dt | $V_D = V_{DRM}$; gate open; $T_J = 100^\circ\text{C}$ | 400V | MIN. | 450 | | V/ μs |
| | | 600V | | 425 | | |
| | | 800V | | 400 | | |
| | | 1000V | | 200 | | |
| | $V_D = V_{DRM}$; gate open; $T_J = 125^\circ\text{C}$ | 400V | 350 | | | |
| | | 600V | 325 | | | |
| 800V | | 300 | | | | |
| V_{GD} | $V_D = V_{DRM}$ $R_L = 3.3 \text{ k}\Omega$ $T_J = 125^\circ\text{C}$ | - | MIN. | 0.2 | | V |
| I_H | $I_T = 400\text{mA}$ (initial) | - | MAX. | 40 | 50 | mA |
| t_q | (1) | - | MAX. | 35 | | μs |
| t_{gt} | $I_G = 2 \times I_{GT}$ $\text{PW} = 15\mu\text{s}$ $I_T = 40\text{A}$ | - | TYP. | 2 | | μs |

Note: xx = voltage, x = package

(1) $I_T = 2\text{A}$; $t_p = 50\mu\text{s}$; $dv/dt = 5\text{V}/\mu\text{s}$; $di/dt = 30\text{A}/\mu\text{s}$

Static Characteristics

| Symbol | Test Conditions | | Value | Unit | | |
|---------------------|---|---------------------|------------|-------------|-----|---------|
| V_{TM} | 20A Device $I_T = 40A$; $t_p = 380\mu s$ | | MAX. | 1.6 | V | |
| | 25A Device $I_T = 50A$; $t_p = 380\mu s$ | | | | | |
| I_{DRM} / I_{RRM} | V_{DRM} / V_{RRM} | $T_J = 25^\circ C$ | MAX. | 400 – 600V | 10 | μA |
| | | | | 800 – 1000V | 20 | |
| | | | | 400 – 600V | 500 | |
| | | $T_J = 100^\circ C$ | 800V | 1000 | | |
| | | | 1000V | 3000 | | |
| | | | 400 – 600V | 1000 | | |
| | | $T_J = 125^\circ C$ | 800V | 2000 | | |

Thermal Resistances

| Symbol | Parameter | Value | Unit | |
|-------------------|-----------------------|-----------------|------|--------------|
| $R_{\theta(J-C)}$ | Junction to case (AC) | Sxx25R / Sxx25N | 1.0 | $^\circ C/W$ |
| | | Sxx20L / Sxx25L | 2.4 | |
| $R_{\theta(J-A)}$ | Junction to ambient | Sxx25R | 40 | $^\circ C/W$ |
| | | Sxx20L / Sxx25L | 50 | |

Note: xx = voltage

Figure 1: Normalized DC Gate Trigger Current vs. Junction Temperature

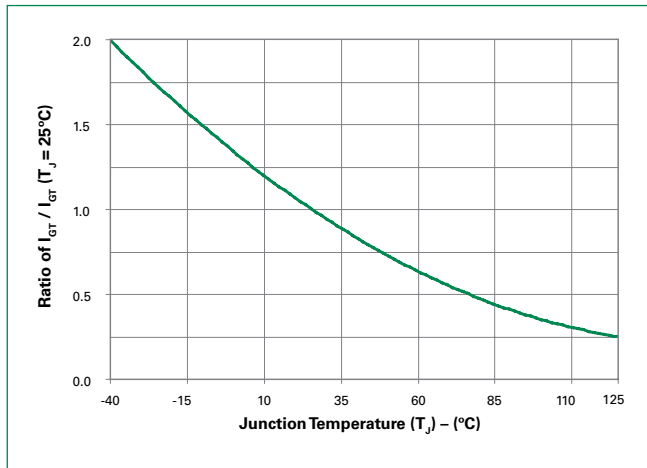

Figure 2: Normalized DC Gate Trigger Voltage vs. Junction Temperature

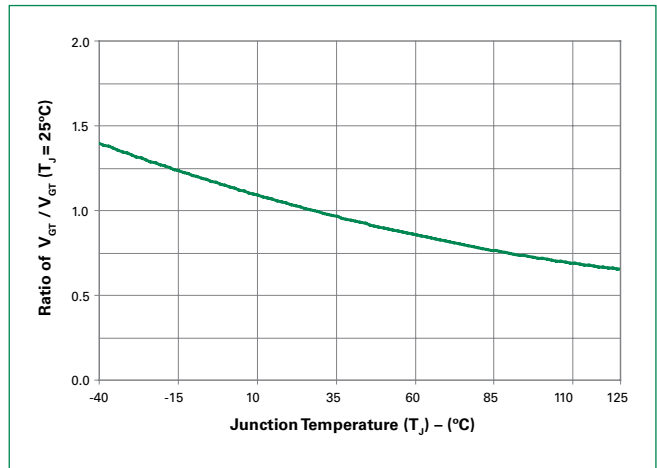

Figure 3: Normalized DC Holding Current vs. Junction Temperature

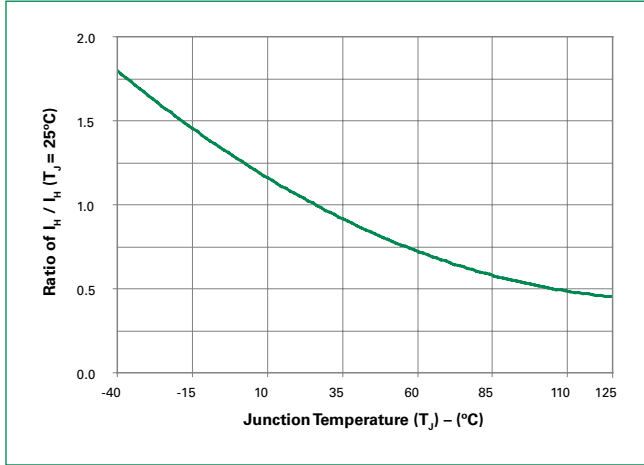

Figure 4: On-State Current vs. On-State Voltage (Typical)

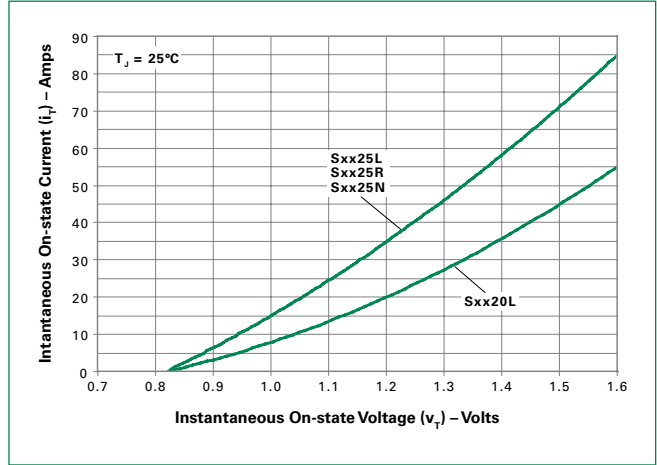

Figure 5: Power Dissipation (Typical) vs. RMS On-State Current

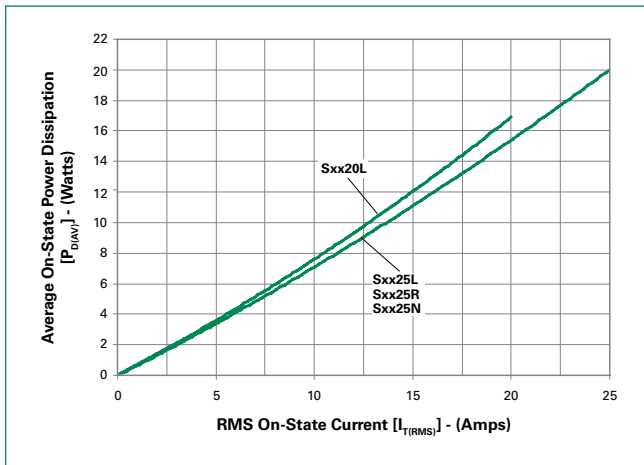

Figure 6: Maximum Allowable Case Temperature vs. RMS On-State Current

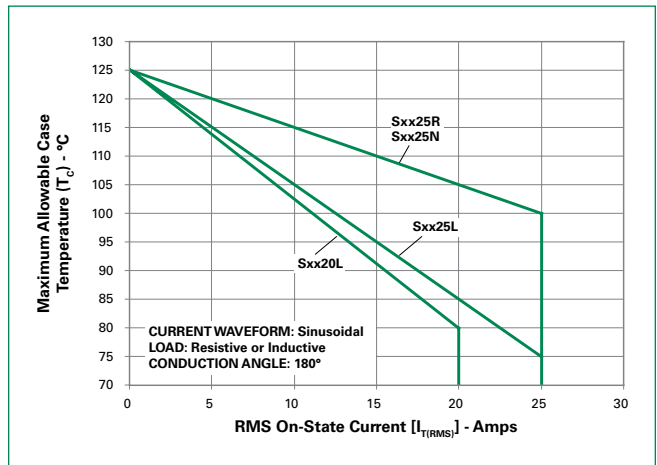

Figure 7: Maximum Allowable Case Temperature vs. Average On-State Current

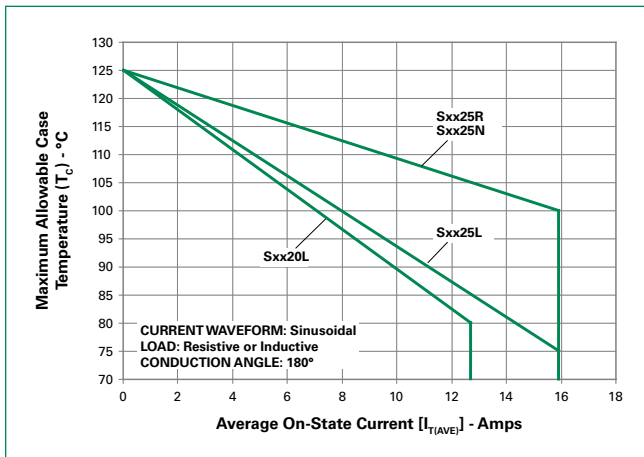

Figure 8: Maximum Allowable Ambient Temperature vs. RMS On-State Current

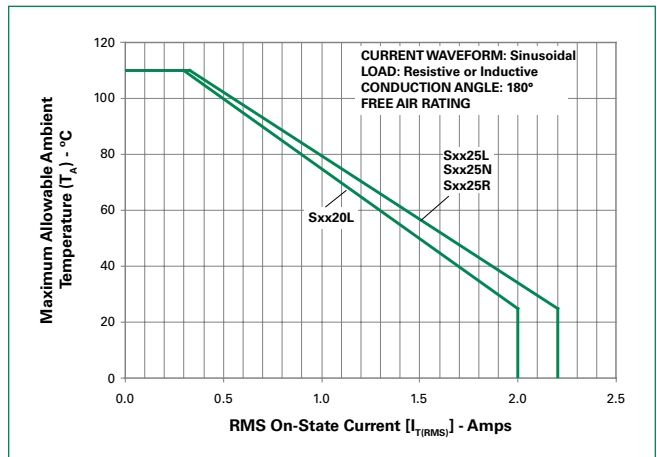
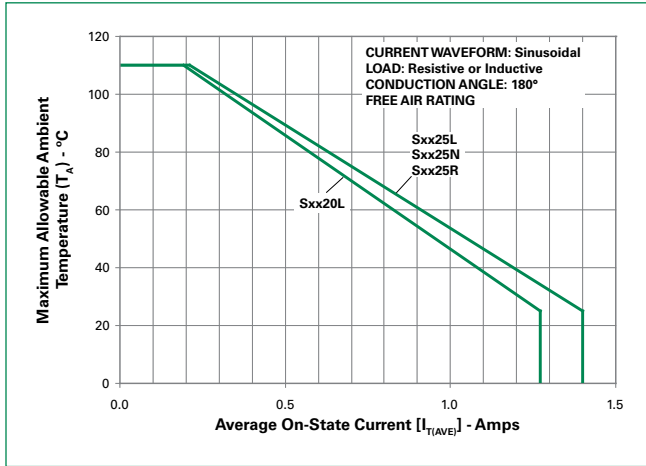

Figure 9: Maximum Allowable Ambient Temperature vs. Average On-State Current



Note: xx = voltage

Figure 10: Peak Capacitor Discharge Current

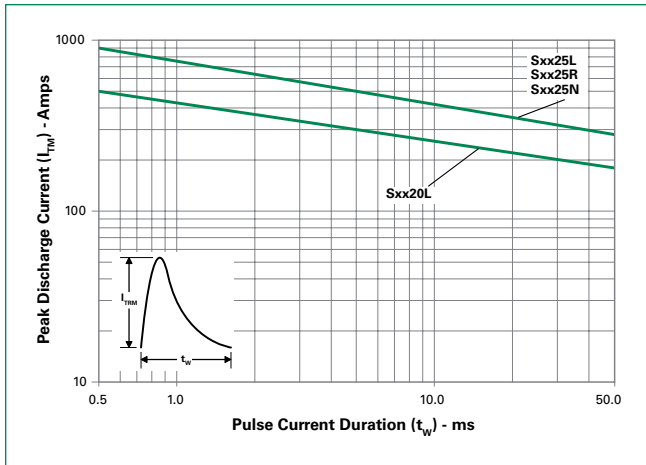

Figure 11: Peak Capacitor Discharge Current Derating

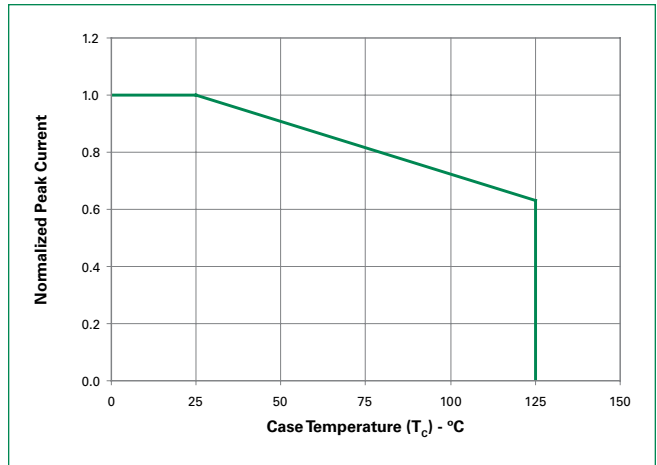
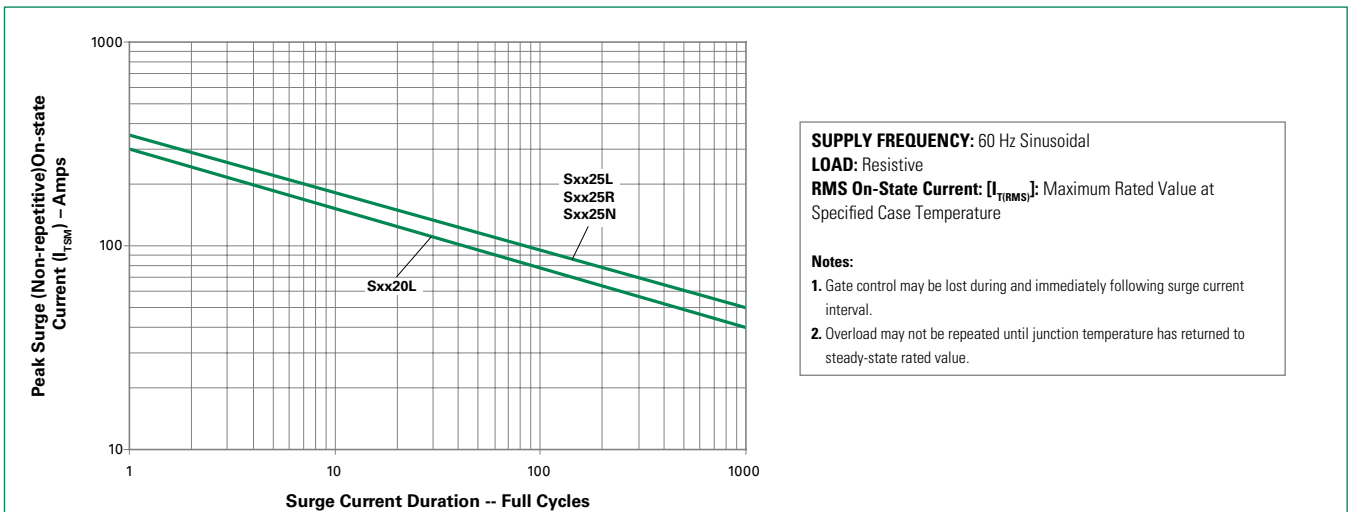
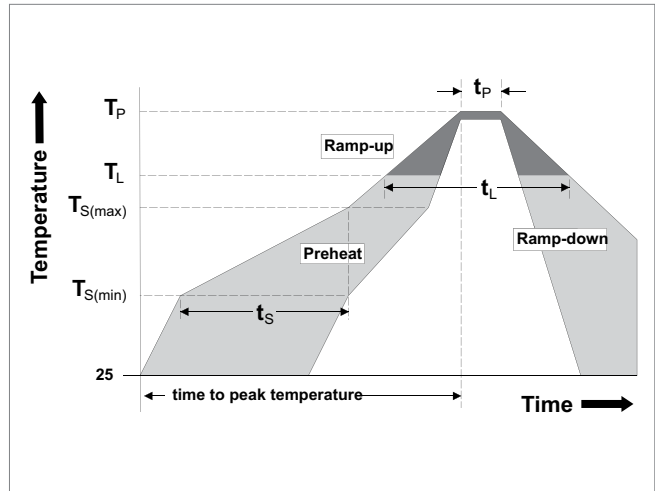

Figure 12: Surge Peak On-State Current vs. Number of Cycles



Soldering Parameters

| | | |
|--|------------------------------------|-------------------------|
| Reflow Condition | | Pb – Free assembly |
| Pre Heat | - Temperature Min ($T_{s(min)}$) | 150°C |
| | - Temperature Max ($T_{s(max)}$) | 200°C |
| | - Time (min to max) (t_s) | 60 – 180 secs |
| Average ramp up rate (Liquidus Temp) (T_L) to peak | | 5°C/second max |
| $T_{s(max)}$ to T_L - Ramp-up Rate | | 5°C/second max |
| Reflow | - Temperature (T_L) (Liquidus) | 217°C |
| | - Temperature (t_L) | 60 – 150 seconds |
| Peak Temperature (T_p) | | 260 ^{+0/-5} °C |
| Time within 5°C of actual peak Temperature (t_p) | | 20 – 40 seconds |
| Ramp-down Rate | | 5°C/second max |
| Time 25°C to peak Temperature (T_p) | | 8 minutes Max. |
| Do not exceed | | 280°C |



Physical Specifications

| | |
|------------------------|---|
| Terminal Finish | 100% Matte Tin-plated |
| Body Material | UL recognized epoxy meeting flammability classification 94V-0 |
| Lead Material | Copper Alloy |

Design Considerations

Careful selection of the correct device for the application's operating parameters and environment will go a long way toward extending the operating life of the Thyristor. Good design practice should limit the maximum continuous current through the main terminals to 75% of the device rating. Other ways to ensure long life for a power discrete semiconductor are proper heat sinking and selection of voltage ratings for worst case conditions. Overheating, overvoltage (including dv/dt), and surge currents are the main killers of semiconductors. Correct mounting, soldering, and forming of the leads also help protect against component damage.

Environmental Specifications

| Test | Specifications and Conditions |
|----------------------------------|--|
| AC Blocking | MIL-STD-750, M-1040, Cond A Applied Peak AC voltage @ 125°C for 1008 hours |
| Temperature Cycling | MIL-STD-750, M-1051, 100 cycles; -40°C to +150°C; 15-min dwell-time |
| Temperature/Humidity | EIA / JEDEC, JESD22-A101 1008 hours; 320V - DC: 85°C; 85% rel humidity |
| High Temp Storage | MIL-STD-750, M-1031, 1008 hours; 150°C |
| Low-Temp Storage | 1008 hours; -40°C |
| Resistance to Solder Heat | MIL-STD-750 Method 2031 |
| Solderability | ANSI/J-STD-002, category 3, Test A |
| Lead Bend | MIL-STD-750, M-2036 Cond E |

Dimensions — TO-220AB (R-Package) — Non-Isolated Mounting Tab Common with Center Lead

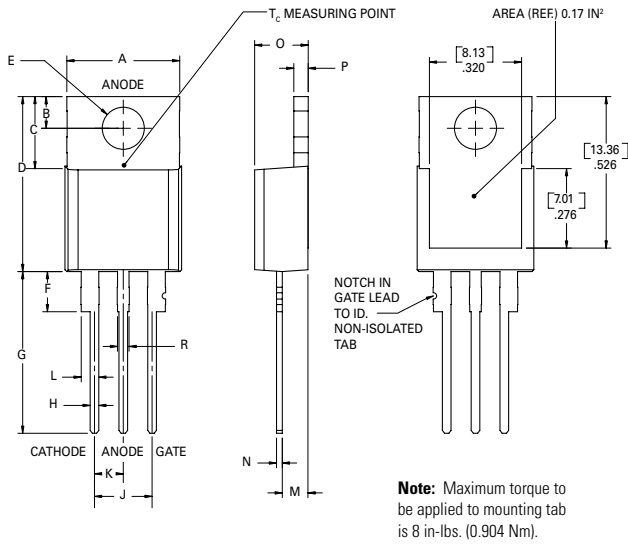

| Dimension | Inches | | Millimeters | |
|-----------|--------|-------|-------------|-------|
| | Min | Max | Min | Max |
| A | 0.380 | 0.420 | 9.65 | 10.67 |
| B | 0.105 | 0.115 | 2.67 | 2.92 |
| C | 0.230 | 0.250 | 5.84 | 6.35 |
| D | 0.590 | 0.620 | 14.99 | 15.75 |
| E | 0.142 | 0.147 | 3.61 | 3.73 |
| F | 0.110 | 0.130 | 2.79 | 3.30 |
| G | 0.540 | 0.575 | 13.72 | 14.61 |
| H | 0.025 | 0.035 | 0.64 | 0.89 |
| J | 0.195 | 0.205 | 4.95 | 5.21 |
| K | 0.095 | 0.105 | 2.41 | 2.67 |
| L | 0.060 | 0.075 | 1.52 | 1.91 |
| M | 0.085 | 0.095 | 2.16 | 2.41 |
| N | 0.018 | 0.024 | 0.46 | 0.61 |
| O | 0.178 | 0.188 | 4.52 | 4.78 |
| P | 0.045 | 0.060 | 1.14 | 1.52 |
| R | 0.038 | 0.048 | 0.97 | 1.22 |

Dimensions — TO-220AB (L-Package) — Isolated Mounting Tab

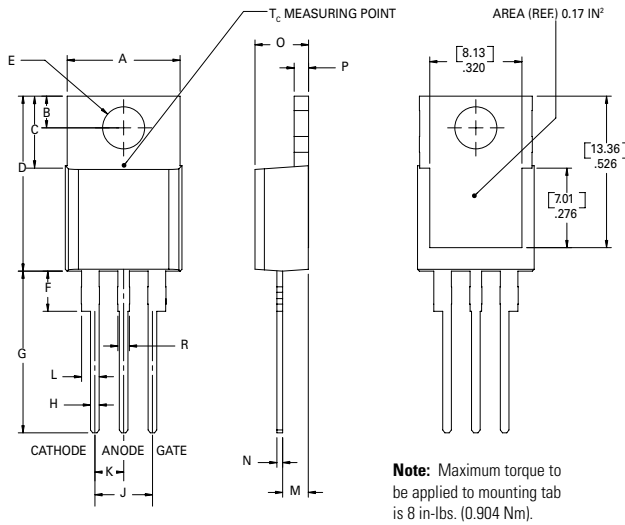

| Dimension | Inches | | Millimeters | |
|-----------|--------|-------|-------------|-------|
| | Min | Max | Min | Max |
| A | 0.380 | 0.420 | 9.65 | 10.67 |
| B | 0.105 | 0.115 | 2.67 | 2.92 |
| C | 0.230 | 0.250 | 5.84 | 6.35 |
| D | 0.590 | 0.620 | 14.99 | 15.75 |
| E | 0.142 | 0.147 | 3.61 | 3.73 |
| F | 0.110 | 0.130 | 2.79 | 3.30 |
| G | 0.540 | 0.575 | 13.72 | 14.61 |
| H | 0.025 | 0.035 | 0.64 | 0.89 |
| J | 0.195 | 0.205 | 4.95 | 5.21 |
| K | 0.095 | 0.105 | 2.41 | 2.67 |
| L | 0.060 | 0.075 | 1.52 | 1.91 |
| M | 0.085 | 0.095 | 2.16 | 2.41 |
| N | 0.018 | 0.024 | 0.46 | 0.61 |
| O | 0.178 | 0.188 | 4.52 | 4.78 |
| P | 0.045 | 0.060 | 1.14 | 1.52 |
| R | 0.038 | 0.048 | 0.97 | 1.22 |

Dimensions –TO- 263AB (N-package) – D²-Pak Surface Mount

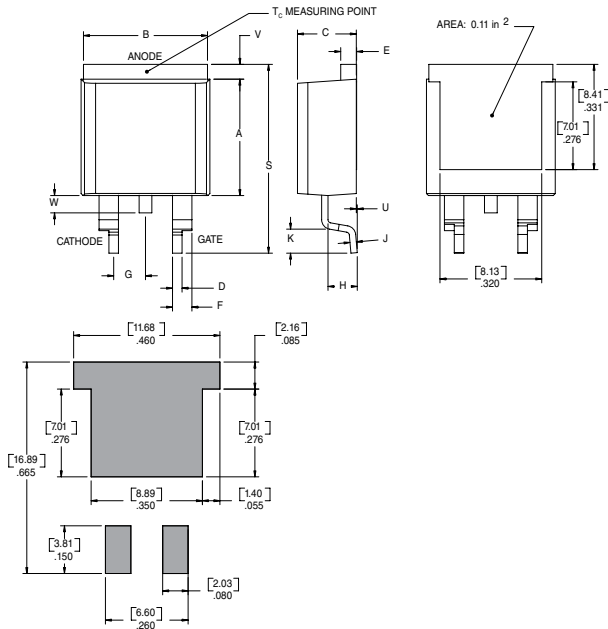

| Dimension | Inches | | Millimeters | |
|-----------|--------|-------|-------------|-------|
| | Min | Max | Min | Max |
| A | 0.360 | 0.370 | 9.14 | 9.40 |
| B | 0.380 | 0.420 | 9.65 | 10.67 |
| C | 0.178 | 0.188 | 4.52 | 4.78 |
| D | 0.025 | 0.035 | 0.64 | 0.89 |
| E | 0.045 | 0.060 | 1.14 | 1.52 |
| F | 0.060 | 0.075 | 1.52 | 1.91 |
| G | 0.095 | 0.105 | 2.41 | 2.67 |
| H | 0.092 | 0.102 | 2.34 | 2.59 |
| J | 0.018 | 0.024 | 0.46 | 0.61 |
| K | 0.090 | 0.110 | 2.29 | 2.79 |
| S | 0.590 | 0.625 | 14.99 | 15.88 |
| V | 0.035 | 0.045 | 0.89 | 1.14 |
| U | 0.002 | 0.010 | 0.05 | 0.25 |
| W | 0.040 | 0.070 | 1.016 | 1.78 |

Product Selector

| Part Number | Voltage | | | | Gate Sensitivity | Type | Package |
|-------------|---------|------|------|-------|------------------|--------------|---------|
| | 400V | 600V | 800V | 1000V | | | |
| Sxx20L | X | X | X | X | 30mA | Standard SCR | TO-220L |
| Sxx25L | X | X | X | X | 35mA | Standard SCR | TO-220L |
| Sxx25R | X | X | X | X | 35mA | Standard SCR | TO-220R |
| Sxx25N | X | X | X | X | 35mA | Standard SCR | TO-263 |

Note: xx = Voltage

Packing Options

| Part Number | Marking | Weight | Packing Mode | Base Quantity |
|-------------|---------|--------|------------------|--------------------|
| Sxx20LTP | Sxx20L | 2.2g | Tube | 1000 (50 per tube) |
| Sxx25LTP | Sxx25L | 2.2g | Tube | 1000 (50 per tube) |
| Sxx25RTP | Sxx25R | 2.2g | Tube | 1000 (50 per tube) |
| Sxx25NTP | Sxx25N | 1.6g | Tube | 1000 (50 per tube) |
| Sxx25NRP | Sxx25N | 1.6g | Embossed Carrier | 500 |

Note: xx = Voltage

TO-263 Embossed Carrier Reel Pack (RP) Specifications

Meets all EIA-481-2 Standards

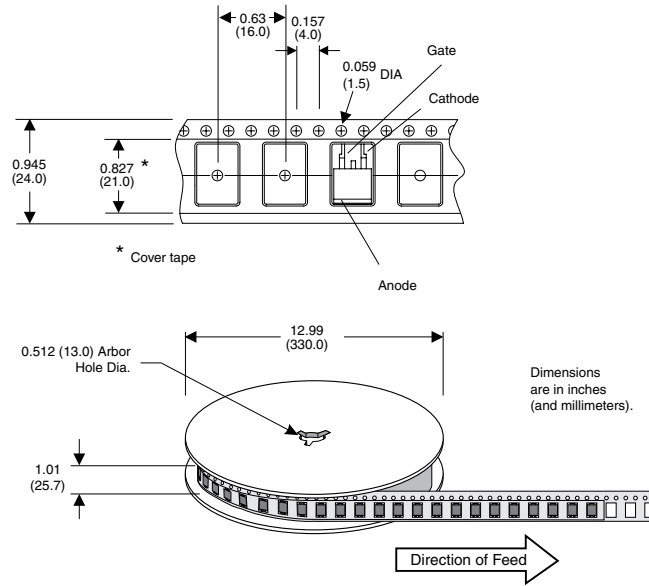

Dimensions are in inches (and millimeters).

Part Numbering System

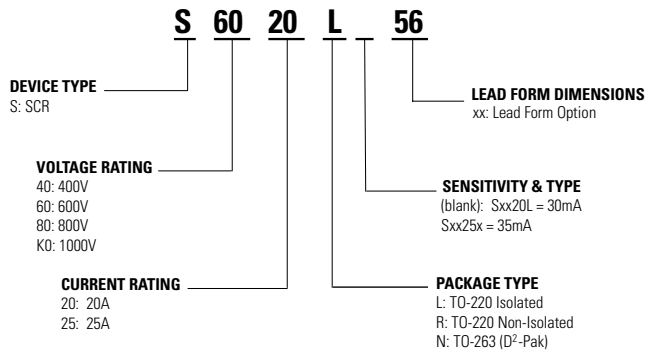

Part Marking System

TO-220 AB - (L and R Package)
TO-263 AB - (N Package)

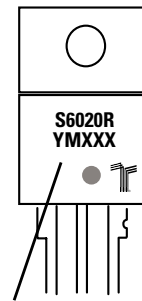

Date Code Marking
Y: Year Code
M: Month Code
XXX: Lot Trace Code

Looking for pricing, stock, or lifecycle information?

Click below to explore more details on WIN SOURCE:

 [View S8025R on WIN SOURCE](#)

 [Littelfuse Inc. Information](#)

Optimize Your Supply Chain with WIN SOURCE Solutions

-  Global Sourcing Solution
-  Obsolete Management
-  Cost Control Management
-  Shortage Management
-  Alternative Solution
-  Excess Inventory Management