



**THE DATASHEET OF  
ADS8326IBDRBT**



# 16-Bit, High-Speed, 2.7V to 5.5V *microPower* Sampling ANALOG-TO-DIGITAL CONVERTER

Check for Samples: [ADS8326](#)

## FEATURES

- 16 Bits No Missing Codes (Full-Supply Range, High or Low Grade)
- Very Low Noise: 3LSB<sub>PP</sub>
- Excellent Linearity:  
±1LSB typ, ±1.5LSB max INL  
±0.6LSB typ, ±1LSB max DNL  
±1mV max Offset  
±12LSB typ Gain Error
- *microPower*:  
10mW at 5V, 250kHz  
4mW at 2.7V, 200kHz  
2mW at 2.7V, 100kHz  
0.2mW at 2.7V, 10kHz
- MSOP-8 and SON-8 Packages (SON-8 package same as 3x3 QFN)
- 16-Bit Upgrade to the 12-Bit ADS7816 and ADS7822
- Pin-Compatible with the [ADS7816](#), [ADS7822](#), [ADS7826](#), [ADS7827](#), [ADS7829](#), [ADS8320](#), and [ADS8325](#)
- Serial ( SPI™/SSI ) Interface

## APPLICATIONS

- Battery-Operated Systems
- Remote Data Acquisition
- Isolated Data Acquisition
- Simultaneous Sampling, Multichannel Systems
- Industrial Controls
- Robotics
- Vibration Analysis

## DESCRIPTION

The ADS8326 is a 16-bit, sampling, analog-to-digital (A/D) converter specified for a supply voltage range from 2.7V to 5.5V. It requires very little power, even when operating at the full data rate. At lower data rates, the high speed of the device enables it to spend most of its time in the power-down mode. For example, the average power dissipation is less than 0.2mW at a 10kHz data rate.

The ADS8326 offers excellent linearity and very low noise and distortion. It also features a synchronous serial (SPI/SSI-compatible) interface and a differential input. The reference voltage can be set to any level within the range of 0.1V to V<sub>DD</sub>.

Low power and small size make the ADS8326 ideal for portable and battery-operated systems. It is also a perfect fit for remote data-acquisition modules, simultaneous multichannel systems, and isolated data acquisition. The ADS8326 is available in either an MSOP-8 and an SON-8 package.

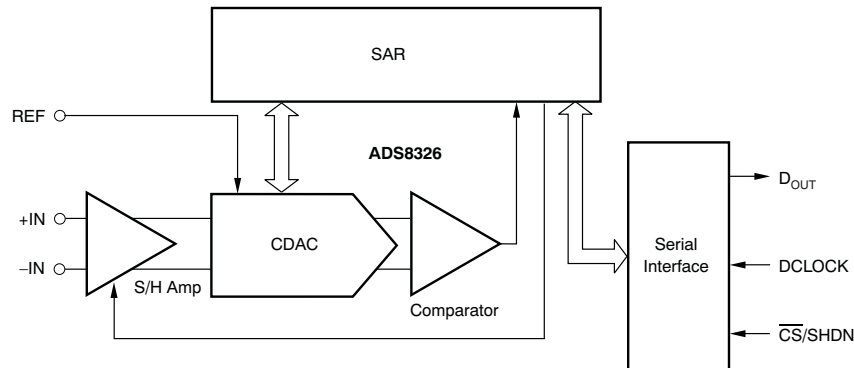

Please be aware that an important notice concerning availability, standard warranty, and use in critical applications of Texas Instruments semiconductor products and disclaimers thereto appears at the end of this data sheet.

SPI is a trademark of Motorola, Inc.

All other trademarks are the property of their respective owners.



This integrated circuit can be damaged by ESD. Texas Instruments recommends that all integrated circuits be handled with appropriate precautions. Failure to observe proper handling and installation procedures can cause damage.

ESD damage can range from subtle performance degradation to complete device failure. Precision integrated circuits may be more susceptible to damage because very small parametric changes could cause the device not to meet its published specifications.

**ORDERING INFORMATION<sup>(1)</sup>**

PRODUCT	MAXIMUM INTEGRAL LINEARITY ERROR (LSB) <sup>(2)</sup>	NO MISSING CODES ERROR (LSB)	PACKAGE-LEAD	PACKAGE DESIGNATOR	SPECIFIED TEMPERATURE RANGE	PACKAGE MARKING	ORDERING NUMBER	TRANSPORT MEDIA, QUANTITY
ADS8326I	±3	16	MSOP-8	DGK	-40°C to +85°C	D26	ADS8326IDGKT	Tape and Reel, 250
							ADS8326IDGKR	Tape and Reel, 2500
ADS8326IB	±1.5	16	MSOP-8	DGK	-40°C to +85°C	D26	ADS8326IBDGKT	Tape and Reel, 250
							ADS8326IBDGKR	Tape and Reel, 2500
ADS8326I	±3	16	SON-8	DRB	-40°C to +85°C	D26	ADS8326IDRBT	Tape and Reel, 250
							ADS8326IDRBR	Tape and Reel, 2500
ADS8326IB	±1.5	16	SON-8	DRB	-40°C to +85°C	D26	ADS8326IBDRBT	Tape and Reel, 250
							ADS8326IBDRBR	Tape and Reel, 2500

- (1) For the most current package and ordering information, see the Package Option Addendum located at the end of this data sheet, or see the TI website at [www.ti.com](http://www.ti.com).
- (2) **Maximum Integral Linearity Error** specifies a 5V power supply and reference voltage.

**ABSOLUTE MAXIMUM RATINGS<sup>(1)</sup>**

Over operating free-air temperature range (unless otherwise noted).

	ADS8326	UNIT
Supply voltage, V <sub>DD</sub> to GND	-0.3 to +7	V
Analog input voltage <sup>(2)</sup>	-0.3 to V <sub>DD</sub> + 0.3	V
Reference input voltage <sup>(2)</sup>	-0.3 to V <sub>DD</sub> + 0.3	V
Digital input voltage <sup>(2)</sup>	-0.3 to V <sub>DD</sub> + 0.3	V
Input current to any pin except supply	-20 to +20	mA
Power dissipation	See <a href="#">Dissipation Ratings Table</a>	
Operating virtual junction temperature range, T <sub>J</sub>	-40 to +150	°C
Operating free-air temperature range, T <sub>A</sub>	-40 to +85	°C
Storage temperature range, T <sub>STG</sub>	-65 to +150	°C
Lead Temperature 1.6mm (1/16 inch) from case for 10sec	+260	°C

- (1) Stresses beyond those listed under Absolute Maximum Ratings may cause permanent damage to the device. These are stress ratings only, and functional operation of the device at these or any other conditions beyond those indicated under Recommended Operating Conditions is not implied. Exposure to absolute-maximum rated conditions for extended periods may affect device reliability.
- (2) All voltage values are with respect to ground terminal.

**DISSIPATION RATINGS**

PACKAGE	$R_{\theta JC}$	$R_{\theta JA}$	DERATING FACTOR ABOVE $T_A = +25^\circ\text{C}$	$T_A \leq +25^\circ\text{C}$ POWER RATING	$T_A = +70^\circ\text{C}$ POWER RATING	$T_A = +85^\circ\text{C}$ POWER RATING
DGK	+39.1°C/W	+206.3°C/W	4.847mW/°C	606mW	388mW	315mW
DRB	+5°C/W	+45.8°C/W	3.7mW/°C	370mW	204mW	148mW

**RECOMMENDED OPERATING CONDITIONS**

	MIN	TYP	MAX	UNIT	
Supply voltage, GND to $V_{DD}$	2.7		3.6	V	
Supply voltage, GND to $V_{DD}$	4.5	5.0	5.5	V	
Reference input voltage	0.1		$V_{DD}$	V	
Analog input voltage	–IN to GND	–0.3	0	0.5	V
	+IN to GND	–0.3		$V_{DD} + 0.2$	V
	+IN – (–IN)	0		$V_{REF}$	V
Operating junction temperature, $T_J$	–40		+125	°C	

**ELECTRICAL CHARACTERISTICS:  $V_{DD} = +5V$** 

 At  $-40^\circ\text{C}$  to  $+85^\circ\text{C}$ ,  $V_{REF} = +5V$ ,  $-IN = GND$ ,  $f_{SAMPLE} = 250\text{kHz}$ , and  $f_{DCLOCK} = 24 \times f_{SAMPLE}$ , unless otherwise noted.

PARAMETER	TEST CONDITIONS	ADS8326I			ADS8326IB			UNIT	
		MIN	TYP	MAX	MIN	TYP	MAX		
<b>ANALOG INPUT</b>									
Full-scale range	FSR	+IN – (–IN)	0		$V_{REF}$	0		$V_{REF}$	V
Operating common-mode signal			–0.3		0.5	–0.3		0.5	V
Input resistance	$R_{ON}$	–IN = GND, off		5		5			GΩ
		–IN = GND, on		50	100	50	100		Ω
Input capacitance		–IN = GND, during sampling		48		48			pF
Input leakage current		–IN = GND		±50		±50			nA
Differential input capacitance		+IN to –IN, during sampling		20		20			pF
Full-power bandwidth	FSBW	FS sinewave, SINAD = –60dB		500		500			kHz
<b>DC ACCURACY</b>									
Resolution			16			16			Bits
No missing codes	NMC		16			16			Bits
Integral linearity error	INL		–3	±2	+3	–1.5	±1	+1.5	LSB
Differential linearity error	DNL		–1	±0.5	+2	–1	±0.4	+1	LSB
Offset error	$V_{OS}$		–1.5	±0.75	+1.5	–1	±0.5	+1	mV
Offset error drift	$TCV_{OS}$			±0.2			±0.2		ppm/°C
Gain error	$G_{ERR}$		–24		+24	–12		+12	LSB
Gain error drift	$TCG_{ERR}$			±0.3			±0.3		ppm/°C
Noise				30		30			μVRMS
Power-supply rejection		$4.75V \leq V_{DD} \leq 5.25V$		0.5		0.5			LSB
<b>SAMPLING DYNAMICS</b>									
Conversion time (16 DCLOCKS)	$t_{CONV}$	$24\text{kHz} \leq f_{DCLOCK} \leq 6\text{MHz}$	2.667		666.7	2.667		666.7	μs
Acquisition time (4.5 DCLOCKS)	$t_{AQ}$	$f_{DCLOCK} = 6\text{MHz}$	0.75			0.75			μs
Throughput rate (22 DCLOCKS)					250			250	kSPS
Clock frequency	$f_{DCLOCK}$		0.024		6	0.024		6	MHz

**ELECTRICAL CHARACTERISTICS:  $V_{DD} = +5V$  (continued)**At  $-40^{\circ}C$  to  $+85^{\circ}C$ ,  $V_{REF} = +5V$ ,  $-IN = GND$ ,  $f_{SAMPLE} = 250kHz$ , and  $f_{DLOCK} = 24 \times f_{SAMPLE}$ , unless otherwise noted.

PARAMETER	TEST CONDITIONS	ADS8326I			ADS8326IB			UNIT
		MIN	TYP	MAX	MIN	TYP	MAX	
<b>AC ACCURACY</b>								
Total harmonic distortion	THD	5V <sub>PP</sub> sinewave at 2kHz		-98	-99		dB	
		5V <sub>PP</sub> sinewave at 10kHz		-90	-91		dB	
Spurious-free dynamic range	SFDR	5V <sub>PP</sub> sinewave at 2kHz		102	103		dB	
		5V <sub>PP</sub> sinewave at 10kHz		94	95		dB	
Signal-to-noise ratio	SNR	5V <sub>PP</sub> sinewave at 2kHz		91	91.5		dB	
		5V <sub>PP</sub> sinewave at 10kHz		91	91.5		dB	
Signal-to-noise + distortion	SINAD	5V <sub>PP</sub> sinewave at 2kHz		90	91		dB	
		5V <sub>PP</sub> sinewave at 10kHz		87.5	88		dB	
Effective number of bits	ENOB	5V <sub>PP</sub> sinewave at 2kHz		14.69	14.86		Bits	
		5V <sub>PP</sub> sinewave at 10kHz		14.28	14.35		Bits	
<b>VOLTAGE REFERENCE INPUT</b>								
Reference voltage		0.1		V <sub>DD</sub>	0.1		V <sub>DD</sub>	V
Reference input resistance		$\overline{CS} = GND$ , $f_{SAMPLE} = 0Hz$		5	5		GΩ	
		$\overline{CS} = V_{DD}$		5	5		GΩ	
Reference input capacitance		24			24		pF	
Reference input current		$f_S = 250kHz$		170	220	170	220	μA
		$f_S = 200kHz$		140	180	140	180	μA
		$f_S = 100kHz$		70	90	70	90	μA
		$f_S = 10kHz$		11	14	11	14	μA
		$\overline{CS} = V_{DD}$		0.1		0.1		μA
<b>DIGITAL INPUTS<sup>(1)</sup></b>								
Logic family		CMOS			CMOS			
High-level input voltage	V <sub>IH</sub>	0.7 × V <sub>DD</sub>		V <sub>DD</sub> + 0.3	0.7 × V <sub>DD</sub>		V <sub>DD</sub> + 0.3	V
Low-level input voltage	V <sub>IL</sub>	-0.3		0.3 × V <sub>DD</sub>	-0.3		0.3 × V <sub>DD</sub>	V
Input current	I <sub>IN</sub>	V <sub>I</sub> = V <sub>DD</sub> or GND		-50	+50		+50	nA
Input capacitance	C <sub>I</sub>	5			5		pF	
<b>DIGITAL OUTPUTS<sup>(1)</sup></b>								
Logic family		CMOS			CMOS			
High-level output voltage	V <sub>OH</sub>	V <sub>DD</sub> = 4.5V, I <sub>OH</sub> = -100μA		4.44	4.44		V	
Low-level output voltage	V <sub>OL</sub>	V <sub>DD</sub> = 4.5V, I <sub>OL</sub> = 100μA		0.5	0.5		V	
High-impedance state output current	I <sub>OZ</sub>	$\overline{CS} = V_{DD}$ , V <sub>I</sub> = V <sub>DD</sub> or GND		-50	+50		nA	
Output capacitance	C <sub>O</sub>	5			5		pF	
Load capacitance	C <sub>L</sub>	30			30		pF	
Data format		Straight binary			Straight binary			

(1) Applies for 5.0V nominal supply: V<sub>DD</sub> (min) = 4.5V and V<sub>DD</sub> (max) = 5.5V.

**ELECTRICAL CHARACTERISTICS:  $V_{DD} = +2.7V$** 

 At  $-40^{\circ}C$  to  $+85^{\circ}C$ ,  $V_{REF} = +2.5V$ ,  $-IN = GND$ ,  $f_{SAMPLE} = 200kHz$ , and  $f_{DCLOCK} = 24 \times f_{SAMPLE}$ , unless otherwise noted.

PARAMETER	TEST CONDITIONS	ADS8326I			ADS8326IB			UNIT	
		MIN	TYP	MAX	MIN	TYP	MAX		
<b>ANALOG INPUT</b>									
Full-scale range	FSR	+IN – (–IN)	0		$V_{REF}$	0		$V_{REF}$	V
Operating common-mode signal			–0.3		0.5	–0.3		0.5	V
Input resistance	$R_{ON}$	–IN = GND, off		5		5			G $\Omega$
		–IN = GND, on		100	150	100	150		$\Omega$
Input capacitance		–IN = GND, during sampling		48		48			pF
Input leakage current		–IN = GND		$\pm 50$		$\pm 50$			nA
Differential input capacitance		+IN to –IN, during sampling		20		20			pF
Full-power bandwidth	FSBW	FS sinewave, SINAD = –60dB		60		60			kHz
<b>DC ACCURACY</b>									
Resolution			16			16			Bits
No missing codes	NMC		16			16			Bits
Integral linearity error	INL		–3	$\pm 2$	+3	–2.5	$\pm 1$	+2.5	LSB
Differential linearity error	DNL		–1	$\pm 0.5$	+2	–1	$\pm 0.4$	+1	LSB
Offset error	$V_{OS}$		–1.5	$\pm 0.75$	+1.5	–1	$\pm 0.5$	+1	mV
Offset error drift	$TCV_{OS}$			$\pm 0.2$		$\pm 0.2$			ppm/ $^{\circ}C$
Gain error	$G_{ERR}$			$\pm 33$		$\pm 16$			LSB
Gain error drift	$TCG_{ERR}$			$\pm 0.3$		$\pm 0.3$			ppm/ $^{\circ}C$
Noise				30		30			$\mu V_{RMS}$
Power-supply rejection		$2.7V \leq V_{DD} \leq 3.6V$		0.5		0.5			LSB
<b>SAMPLING DYNAMICS</b>									
Conversion time (16 DCLOCKs)	$t_{CONV}$	$24kHz \leq f_{DCLOCK} \leq 4.8MHz$	3.333		666.7	3.333		666.7	$\mu s$
Acquisition time (4.5 DCLOCKs)	$t_{AQ}$	$f_{DCLOCK} = 4.8MHz$	0.9375			0.9375			$\mu s$
Throughput rate (22 DCLOCKs)					200			200	kSPS
Clock frequency	$f_{DCLOCK}$		0.024		4.8	0.024		4.8	MHz
<b>AC ACCURACY</b>									
Total harmonic distortion	THD	2.5V <sub>pp</sub> sinewave at 2kHz		–88		–88.5			dB
		2.5V <sub>pp</sub> sinewave at 10kHz		–75		–75.5			dB
Spurious-free dynamic range	SFDR	2.5V <sub>pp</sub> sinewave at 2kHz		91		91.5			dB
		2.5V <sub>pp</sub> sinewave at 10kHz		77.5		78			dB
Signal-to-noise ratio	SNR	2.5V <sub>pp</sub> sinewave at 2kHz		86.5		87			dB
		2.5V <sub>pp</sub> sinewave at 10kHz		86		86.5			dB
Signal-to-noise + distortion	SINAD	2.5V <sub>pp</sub> sinewave at 2kHz		85		85.5			dB
		2.5V <sub>pp</sub> sinewave at 10kHz		74.5		75			dB
Effective number of bits	ENOB	2.5V <sub>pp</sub> sinewave at 2kHz		13.86		13.94			Bits
		2.5V <sub>pp</sub> sinewave at 10kHz		12.12		12.20			Bits
<b>VOLTAGE REFERENCE INPUT</b>									
Reference voltage			0.1		$V_{DD}$	0.1		$V_{DD}$	V
Reference input resistance		$\overline{CS} = GND$ , $f_{SAMPLE} = 0Hz$		5		5			G $\Omega$
		$\overline{CS} = V_{DD}$		5		5			G $\Omega$
Reference input capacitance				24		24			pF
Reference input current		$f_S = 200kHz$		70	90	70	90		$\mu A$
		$f_S = 100kHz$		25	33	25	33		$\mu A$
		$f_S = 10kHz$		5	7	5	7		$\mu A$
		$\overline{CS} = V_{DD}$		0.1		0.1			$\mu A$

**ELECTRICAL CHARACTERISTICS:  $V_{DD} = +2.7V$  (continued)**At  $-40^{\circ}C$  to  $+85^{\circ}C$ ,  $V_{REF} = +2.5V$ ,  $-IN = GND$ ,  $f_{SAMPLE} = 200kHz$ , and  $f_{DCLOCK} = 24 \times f_{SAMPLE}$ , unless otherwise noted.

PARAMETER	TEST CONDITIONS	ADS8326I			ADS8326IB			UNIT
		MIN	TYP	MAX	MIN	TYP	MAX	
<b>DIGITAL INPUTS<sup>(1)</sup></b>								
Logic family		LVCMOS			LVCMOS			
High-level input voltage	$V_{IH}$ $V_{DD} = 3.6V$	2		$V_{DD} + 0.3$	2		$V_{DD} + 0.3$	V
Low-level input voltage	$V_{IL}$ $V_{DD} = 2.7V$	-0.3		0.8	-0.3		0.8	V
Input current	$I_{IN}$ $V_I = V_{DD}$ or GND	-50		+50	-50		+50	nA
Input capacitance	$C_I$		5			5		pF
<b>DIGITAL OUTPUTS<sup>(1)</sup></b>								
Logic family		LVCMOS			LVCMOS			
High-level output voltage	$V_{OH}$ $V_{DD} = 2.7V$ , $I_{OH} = -100\mu A$	$V_{DD} - 0.2$			$V_{DD} - 0.2$			V
Low-level output voltage	$V_{OL}$ $V_{DD} = 2.7V$ , $I_{OL} = 100\mu A$				0.2			V
High-impedance state output current	$I_{OZ}$ $\overline{CS} = V_{DD}$ , $V_I = V_{DD}$ or GND	-50		+50	-50		+50	nA
Output capacitance	$C_O$		5			5		pF
Load capacitance	$C_L$			30			30	pF
Data format		Straight binary			Straight binary			

(1) Applies for 3.0V nominal supply:  $V_{DD}$  (min) = 2.7V and  $V_{DD}$  (max) = 3.6V.**ELECTRICAL CHARACTERISTICS**At  $-40^{\circ}C$  to  $+85^{\circ}C$ ,  $-IN = GND$ , and  $f_{DCLOCK} = 24 \times f_{SAMPLE}$ , unless otherwise noted.

PARAMETER	TEST CONDITIONS	ADS8326I			ADS8326IB			UNIT	
		MIN	TYP	MAX	MIN	TYP	MAX		
<b>ANALOG INPUT</b>									
Power supply	$V_{DD}$	Low-voltage levels	2.7		3.6	2.7		3.6	V
		5V logic levels	4.5		5.5	4.5		5.5	V
Operating supply current	$I_{DD}$	$V_{DD} = 2.7V$ , $f_S = 10kHz$ , $f_{DCLOCK} = 4.8MHz$		0.065	0.085		0.065	0.085	mA
		$V_{DD} = 2.7V$ , $f_S = 100kHz$ , $f_{DCLOCK} = 4.8MHz$		0.69	1.0		0.69	1.0	mA
		$V_{DD} = 2.7V$ , $f_S = 200kHz$ , $f_{DCLOCK} = 4.8MHz$		1.38	2.0		1.38	2.0	mA
		$V_{DD} = 5V$ , $f_S = 200kHz$ , $f_{DCLOCK} = 6MHz$		1.9	2.7		1.9	2.7	mA
		$V_{DD} = 5V$ , $f_S = 250kHz$ , $f_{DCLOCK} = 6MHz$		2.0	3.0		2.0	3.0	mA
Power-down supply current	$I_{DD}$	$V_{DD} = 2.7V$		0.1		0.1		$\mu A$	
		$V_{DD} = 5V$		0.2		0.2		$\mu A$	
Power dissipation		$V_{DD} = 2.7V$ , $f_S = 10kHz$ , $f_{DCLOCK} = 4.8MHz$		0.18	0.23		0.18	0.23	mW
		$V_{DD} = 2.7V$ , $f_S = 100kHz$ , $f_{DCLOCK} = 4.8MHz$		1.86	2.7		1.86	2.7	mW
		$V_{DD} = 2.7V$ , $f_S = 200kHz$ , $f_{DCLOCK} = 4.8MHz$		3.73	5.4		3.73	5.4	mW
		$V_{DD} = 5V$ , $f_S = 200kHz$ , $f_{DCLOCK} = 6MHz$		9.5	13.5		9.5	13.5	mW
		$V_{DD} = 5V$ , $f_S = 250kHz$ , $f_{DCLOCK} = 6MHz$		10	15		10	15	mW
Power dissipation in power-down		$V_{DD} = 2.7V$ , $\overline{CS} = V_{DD}$		0.3		0.3		$\mu W$	
		$V_{DD} = 5V$ , $\overline{CS} = V_{DD}$		0.6		0.6		$\mu W$	

## PIN CONFIGURATION

### DGK PACKAGE MSOP-8 (TOP VIEW)

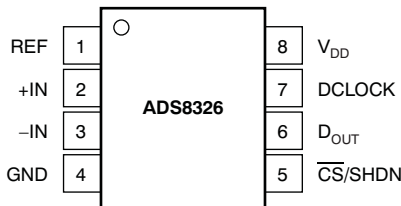

### DRB PACKAGE SON-8 (TOP VIEW)

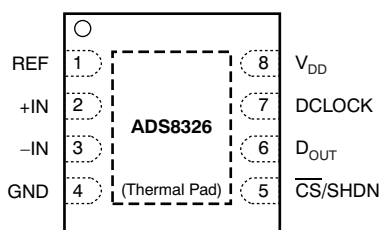

- (1) The thermal pad is internally connected to the substrate. This pad can be connected to the analog ground or left floating. Keep the thermal pad separate from the digital ground, if possible.

## PIN ASSIGNMENTS

PIN		I/O	DESCRIPTION
NAME	NO.		
REF	1	Analog input	Reference input
+IN	2	Analog input	Noninverting input
-IN	3	Analog input	Inverting analog input
GND	4	Power-supply connection	Ground
$\overline{\text{CS}}/\text{SHDN}$	5	Digital input	Chip select when low; Shutdown mode when high.
D <sub>OUT</sub>	6	Digital output	Serial output data word
DCLOCK	7	Digital input	Data clock synchronizes the serial data transfer and determines conversion speed.
V <sub>DD</sub>	8	Power-supply connection	Power supply

### Equivalent Input Circuit ( $V_{DD} = 5.0\text{V}$ )

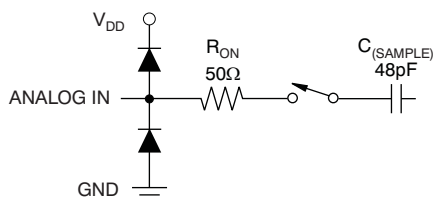

Diode Turn-On Voltage: 0.35V  
Equivalent Analog Input Circuit

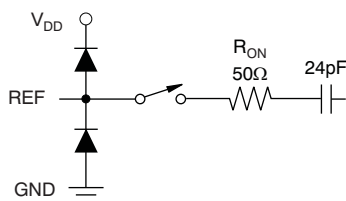

Equivalent Reference Input Circuit

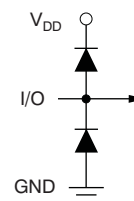

Equivalent Digital Input/Output Circuit

**TIMING INFORMATION**

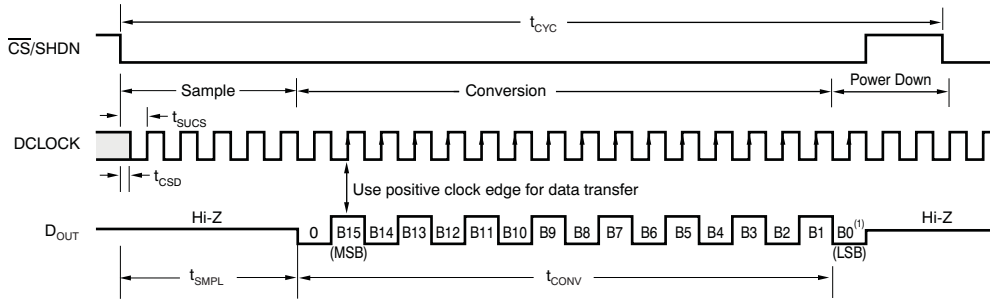

NOTE: (1) A minimum of 22 clock cycles are required for 16-bit conversion; 24 clock cycles are shown. If CS remains low at the end of conversion, a new data stream is shifted out with LSB-first data followed by zeroes indefinitely.

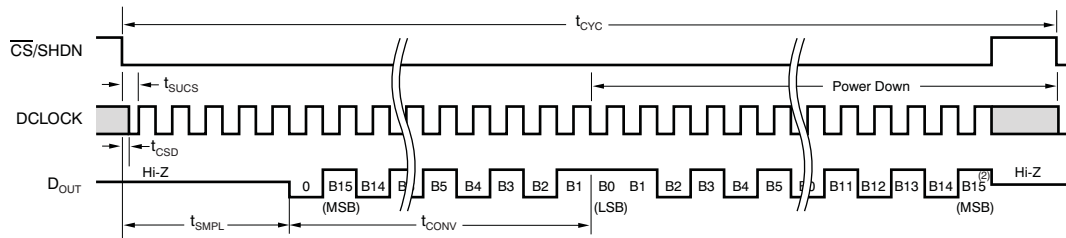

NOTE: (2) After completing the data transfer, if further clocks are applied with CS low, the A/D converter will output zeroes indefinitely.

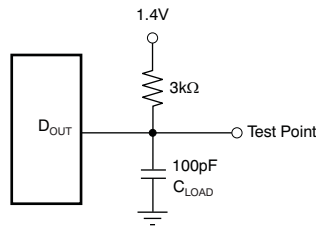

Load Circuit for  $t_{idO}$ ,  $t_r$ , and  $t_f$

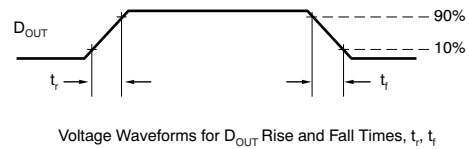

Voltage Waveforms for  $D_{OUT}$  Rise and Fall Times,  $t_r$ ,  $t_f$

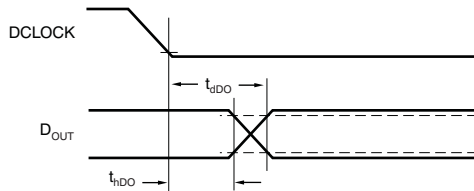

Voltage Waveforms for  $D_{OUT}$  Delay Times,  $t_{idO}$

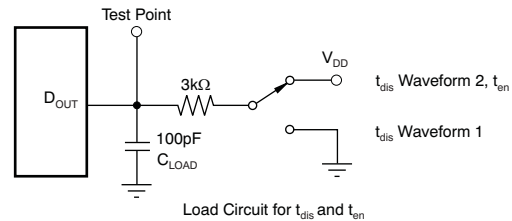

Load Circuit for  $t_{dis}$  and  $t_{en}$

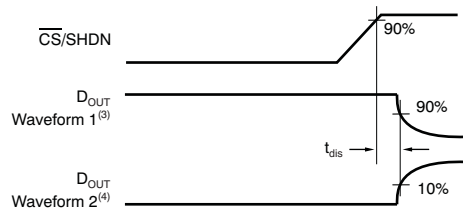

Voltage Waveforms for  $t_{dis}$

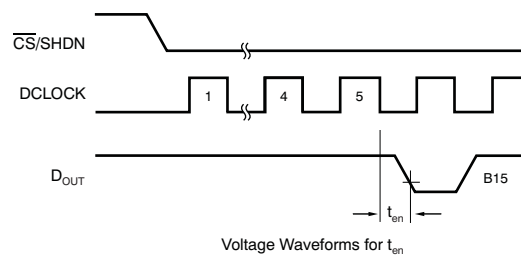

Voltage Waveforms for  $t_{en}$

NOTES: (3) Waveform 1 is for an output with internal conditions such that the output is high unless disabled by the output control.  
 (4) Waveform 2 is for an output with internal conditions such that the output is low unless disabled by the output control.

**Figure 1. Timing Diagrams and Test Circuits for the Parameters in Table 1**

**TIMING INFORMATION (continued)**
**Table 1. Timing Characteristics**

<b>SYMBOL</b>	<b>DESCRIPTION</b>	<b>MIN</b>	<b>TYP</b>	<b>MAX</b>	<b>UNIT</b>
$t_{\text{SMPL}}$	Analog input sample time	4.5		5.0	DCLOCKs
$t_{\text{CONV}}$	Conversion time		16		DCLOCKs
$t_{\text{CYC}}$	Complete cycle time	22			DCLOCKs
$t_{\text{CSD}}$	$\overline{\text{CS}}$ falling to DCLOCK low			0	ns
$t_{\text{SUCS}}$	$\overline{\text{CS}}$ falling to DCLOCK rising	20			ns
$t_{\text{HDO}}$	DCLOCK falling to current $D_{\text{OUT}}$ not valid	5	15		ns
$t_{\text{DIS}}$	$\overline{\text{CS}}$ rising to $D_{\text{OUT}}$ tri-state		70	100	ns
$t_{\text{EN}}$	DCLOCK falling to $D_{\text{OUT}}$ enabled		20	50	ns
$t_{\text{F}}$	$D_{\text{OUT}}$ fall time		5	25	ns
$t_{\text{R}}$	$D_{\text{OUT}}$ rise time		7	25	ns

**TYPICAL CHARACTERISTICS:  $V_{DD} = +5V$**

At  $T_A = +25^\circ C$ ,  $V_{DD} = +5V$ ,  $V_{REF} = +5V$ .  $f_{SAMPLE} = 250kHz$ ,  $f_{CLK} = 24 \times f_{SAMPLE}$ , unless otherwise noted.

**INTEGRAL LINEARITY ERROR  
vs  
CODE**

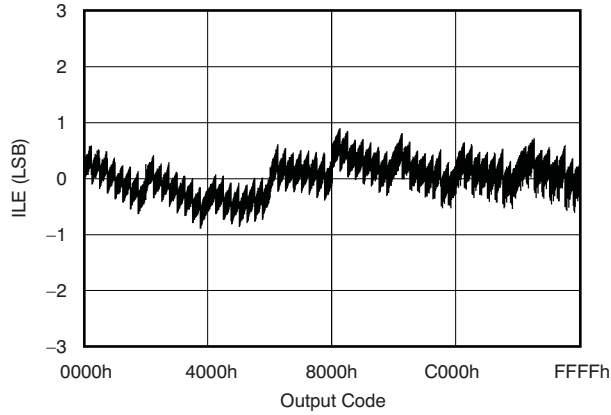

**Figure 2.**

**DIFFERENTIAL LINEARITY ERROR  
vs  
CODE**

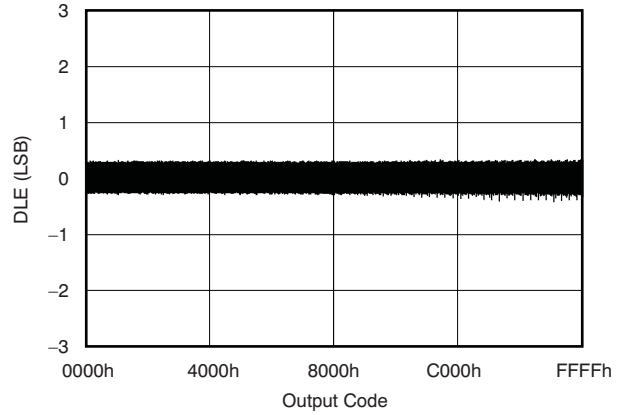

**Figure 3.**

**CHANGE IN OFFSET  
vs  
TEMPERATURE**

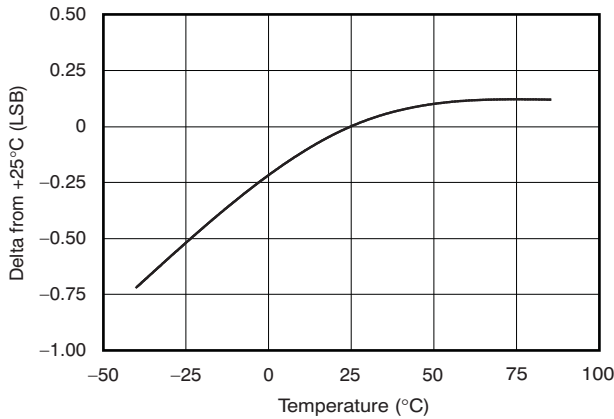

**Figure 4.**

**CHANGE IN GAIN  
vs  
TEMPERATURE**

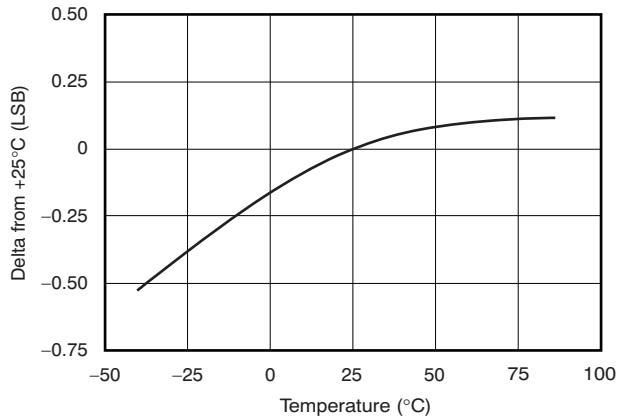
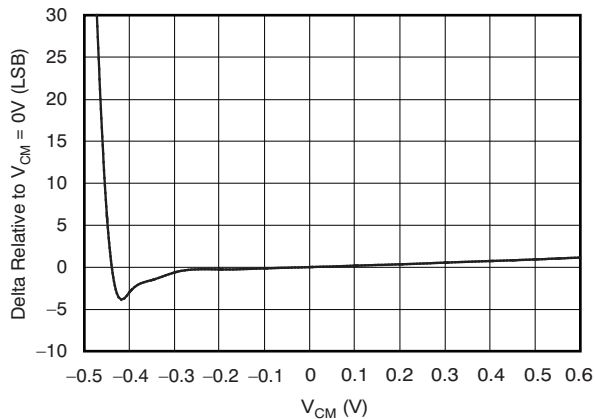

**Figure 5.**

**TYPICAL CHARACTERISTICS:  $V_{DD} = +5V$  (continued)**

At  $T_A = +25^\circ C$ ,  $V_{DD} = +5V$ ,  $V_{REF} = +5V$ .  $f_{SAMPLE} = 250kHz$ ,  $f_{CLK} = 24 \times f_{SAMPLE}$ , unless otherwise noted.

**CHANGE IN OFFSET  
vs  
COMMON-MODE VOLTAGE**



**Figure 6.**

**CHANGE IN GAIN  
vs  
COMMON-MODE VOLTAGE**

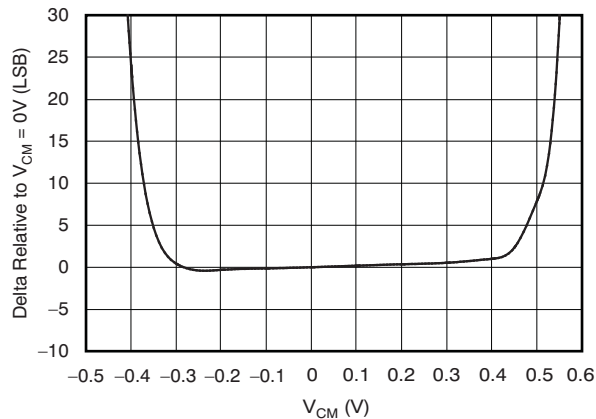

**Figure 7.**

**FREQUENCY SPECTRUM  
(8192 point FFT,  $f_{IN} = 1.9836kHz$ ,  $-0.2dB$ )**

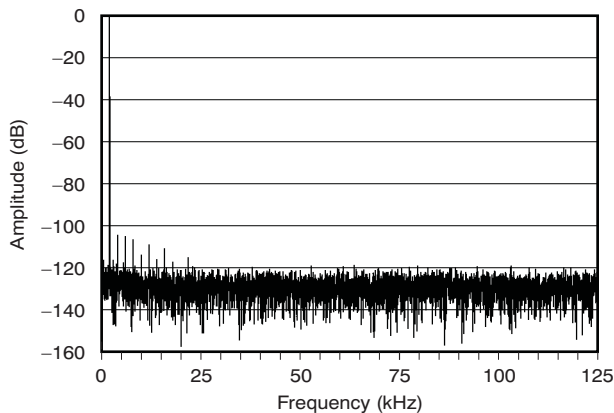

**Figure 8.**

**FREQUENCY SPECTRUM  
(8192 point FFT,  $f_{IN} = 9.9792kHz$ ,  $-0.2dB$ )**

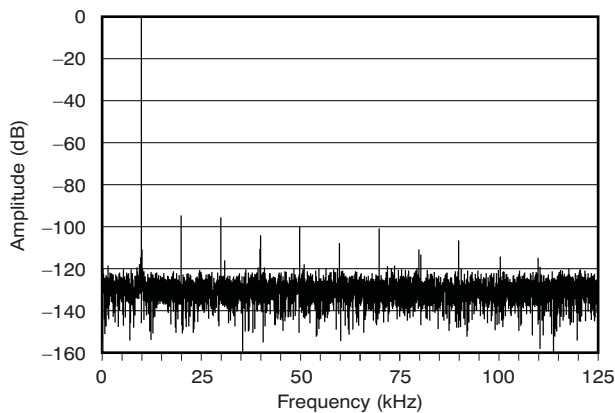

**Figure 9.**

**TYPICAL CHARACTERISTICS:  $V_{DD} = +5V$  (continued)**

At  $T_A = +25^\circ C$ ,  $V_{DD} = +5V$ ,  $V_{REF} = +5V$ .  $f_{SAMPLE} = 250kHz$ ,  $f_{CLK} = 24 \times f_{SAMPLE}$ , unless otherwise noted.

**SIGNAL-TO-NOISE AND  
SIGNAL-TO-NOISE + DISTORTION  
vs  
INPUT FREQUENCY**

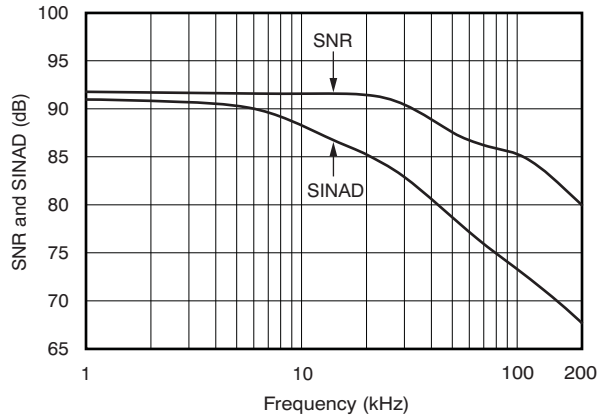

Figure 10.

**SPURIOUS-FREE DYNAMIC RANGE AND  
TOTAL HARMONIC DISTORTION  
vs  
INPUT FREQUENCY**

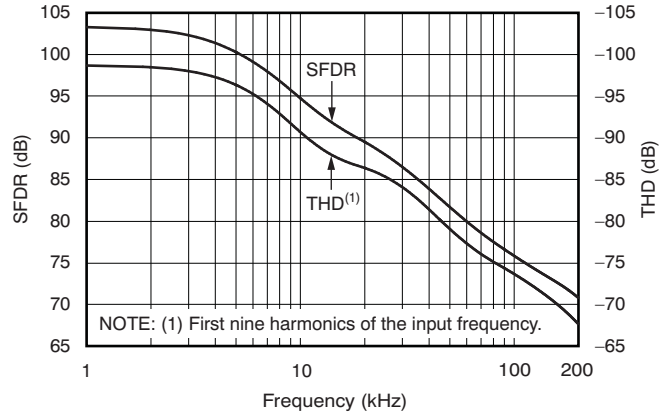

Figure 11.

**EFFECTIVE NUMBER OF BITS  
vs  
INPUT FREQUENCY**

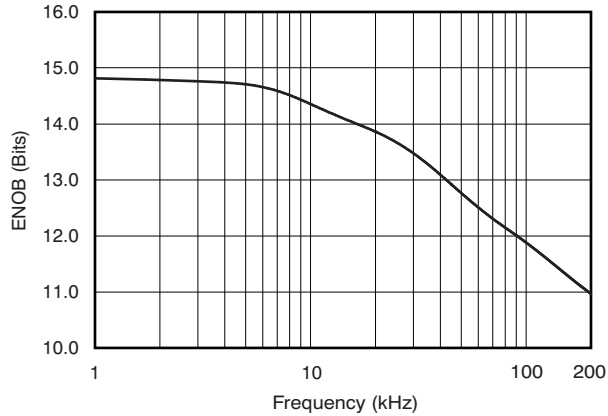

Figure 12.

**CHANGE IN SIGNAL-TO-NOISE + DISTORTION  
vs  
TEMPERATURE**

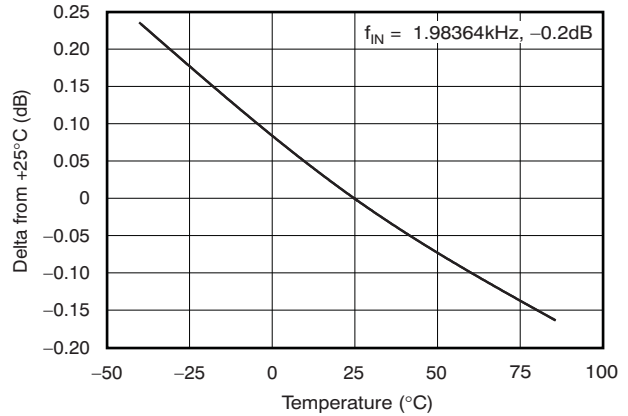
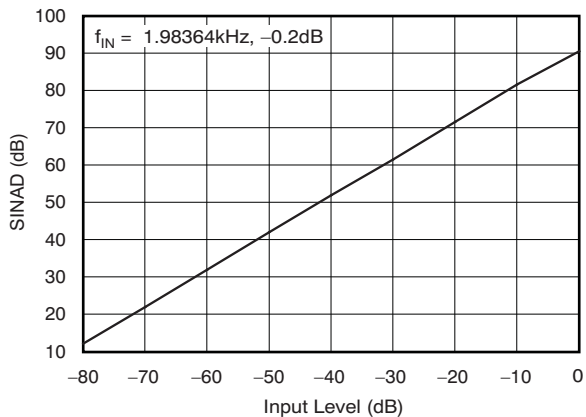

Figure 13.

**TYPICAL CHARACTERISTICS:  $V_{DD} = +5V$  (continued)**

At  $T_A = +25^\circ C$ ,  $V_{DD} = +5V$ ,  $V_{REF} = +5V$ .  $f_{SAMPLE} = 250kHz$ ,  $f_{CLK} = 24 \times f_{SAMPLE}$ , unless otherwise noted.

**SIGNAL-TO-NOISE + DISTORTION  
vs  
INPUT LEVEL**



**Figure 14.**

**PEAK-TO-PEAK NOISE FOR A DC INPUT  
vs  
REFERENCE VOLTAGE**

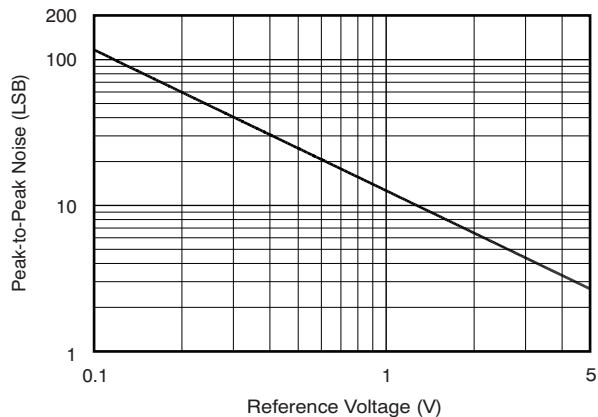

**Figure 15.**

**SUPPLY CURRENT  
vs  
TEMPERATURE**

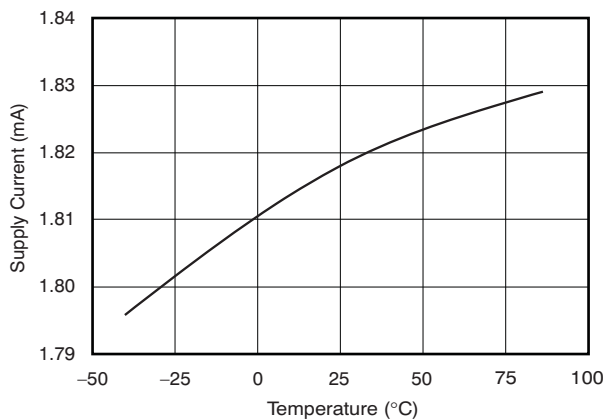

**Figure 16.**

**SUPPLY CURRENT  
vs  
SAMPLING RATE**

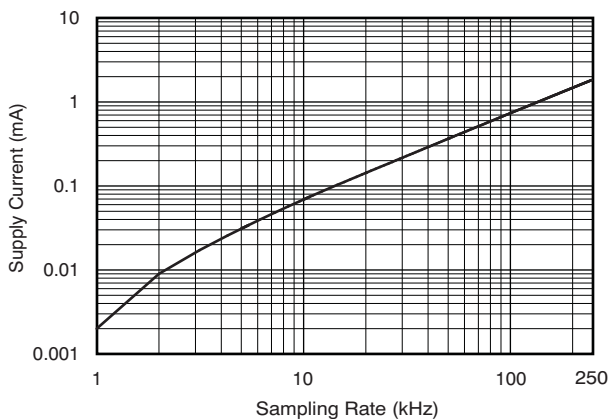
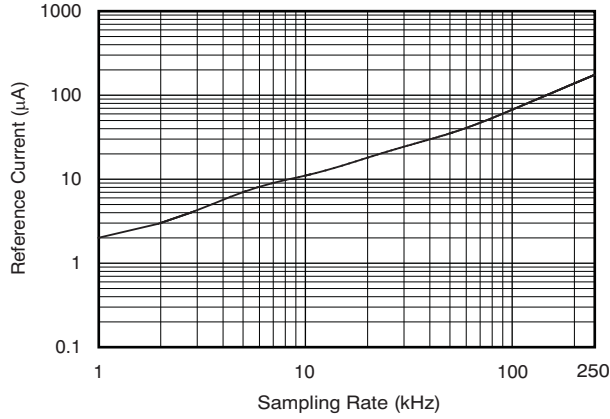

**Figure 17.**

**TYPICAL CHARACTERISTICS:  $V_{DD} = +5V$  (continued)**

At  $T_A = +25^\circ C$ ,  $V_{DD} = +5V$ ,  $V_{REF} = +5V$ .  $f_{SAMPLE} = 250kHz$ ,  $f_{CLK} = 24 \times f_{SAMPLE}$ , unless otherwise noted.

**REFERENCE CURRENT  
vs  
SAMPLING RATE**



**Figure 18.**

**POWER-DOWN CURRENT  
vs  
TEMPERATURE**

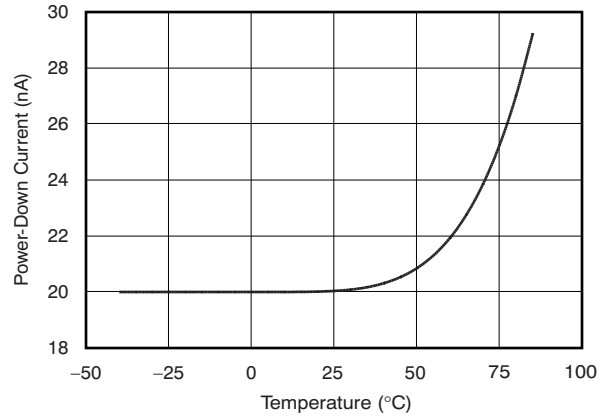

**Figure 19.**

**OUTPUT CODE HISTOGRAM FOR A DC INPUT  
(8192 Conversions)**

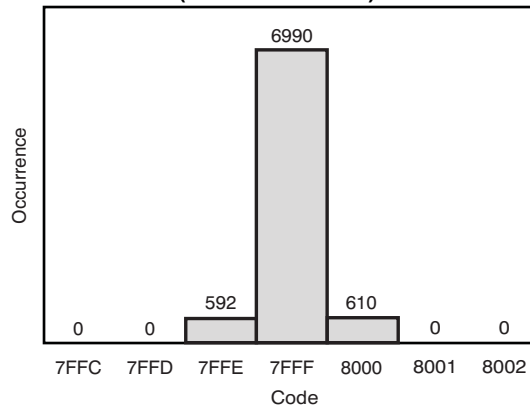

**Figure 20.**

**TYPICAL CHARACTERISTICS:  $V_{DD} = +2.7V$**

At  $T_A = +25^\circ C$ ,  $V_{DD} = +2.7V$ ,  $V_{REF} = +2.5V$ .  $f_{SAMPLE} = 200kHz$ ,  $f_{CLK} = 24 \times f_{SAMPLE}$ , unless otherwise noted.

**INTEGRAL LINEARITY ERROR  
vs  
CODE**

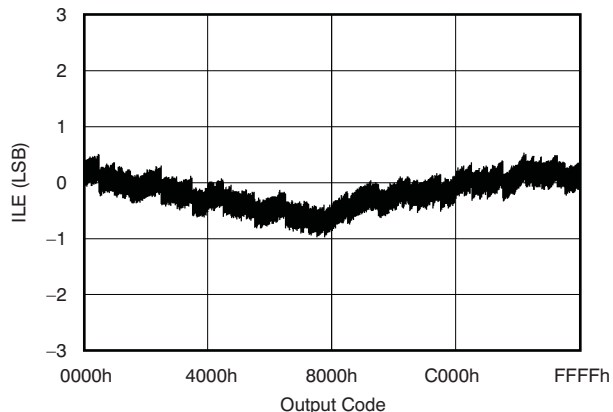

Figure 21.

**DIFFERENTIAL LINEARITY ERROR  
vs  
CODE**

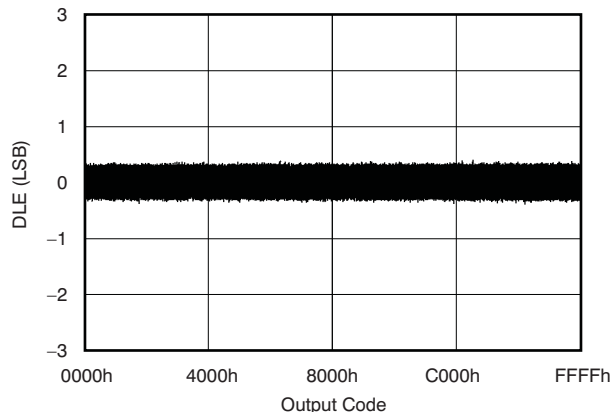

Figure 22.

**CHANGE IN OFFSET  
vs  
TEMPERATURE**

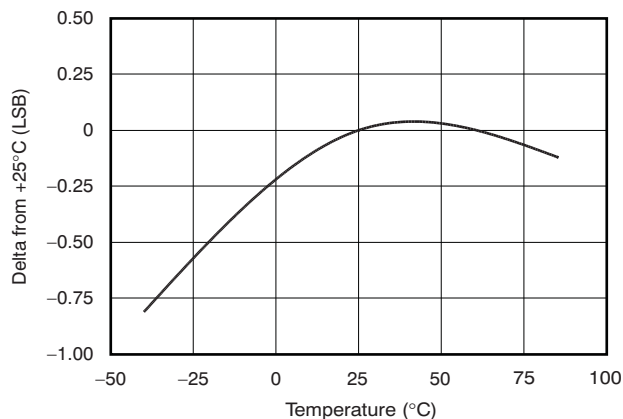

Figure 23.

**CHANGE IN GAIN  
vs  
TEMPERATURE**

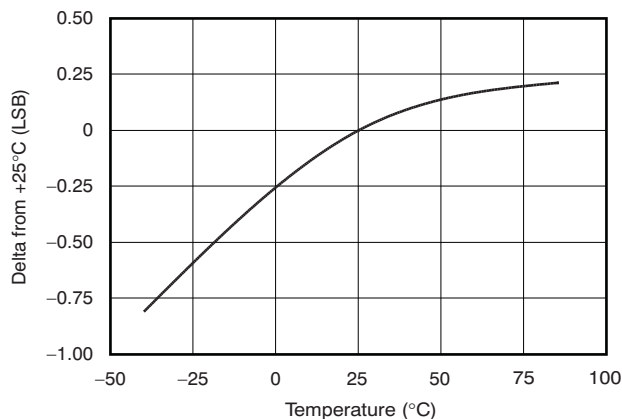

Figure 24.

**TYPICAL CHARACTERISTICS:  $V_{DD} = +2.7V$  (continued)**

At  $T_A = +25^\circ C$ ,  $V_{DD} = +2.7V$ ,  $V_{REF} = +2.5V$ .  $f_{SAMPLE} = 200kHz$ ,  $f_{CLK} = 24 \times f_{SAMPLE}$ , unless otherwise noted.

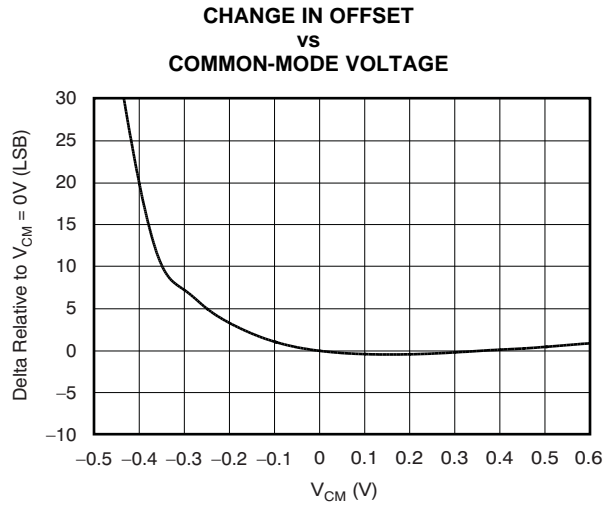

Figure 25.

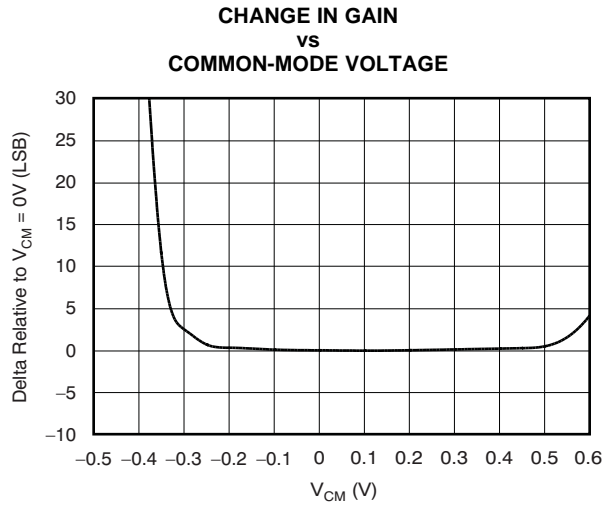

Figure 26.

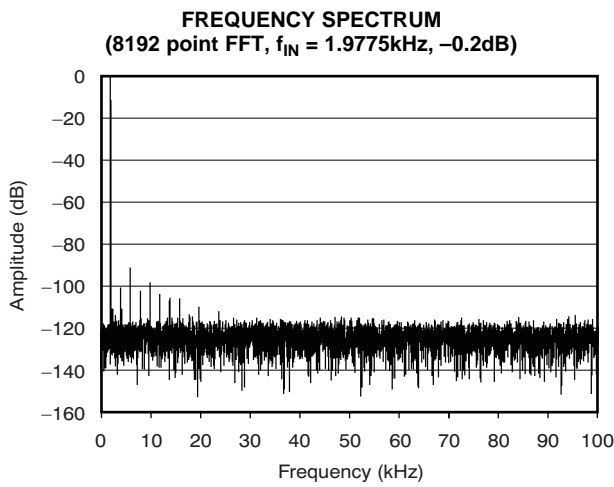

Figure 27.

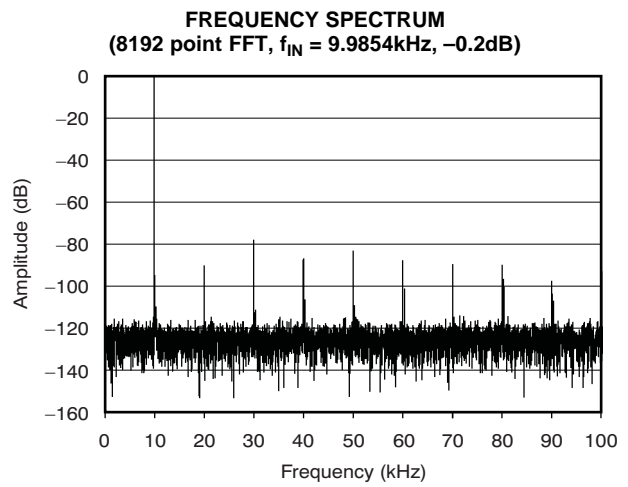
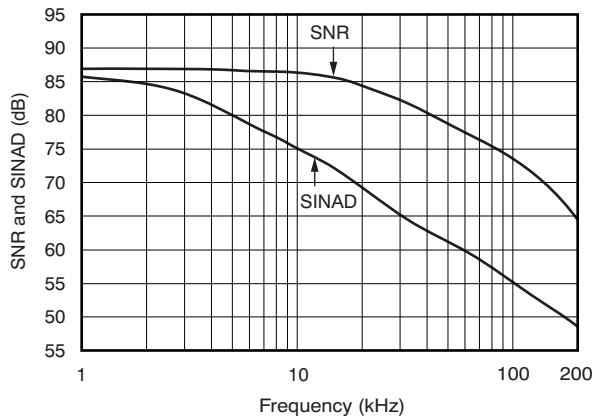

Figure 28.

**TYPICAL CHARACTERISTICS:  $V_{DD} = +2.7V$  (continued)**

At  $T_A = +25^\circ C$ ,  $V_{DD} = +2.7V$ ,  $V_{REF} = +2.5V$ .  $f_{SAMPLE} = 200kHz$ ,  $f_{CLK} = 24 \times f_{SAMPLE}$ , unless otherwise noted.

**SIGNAL-TO-NOISE AND  
SIGNAL-TO-NOISE + DISTORTION  
vs  
INPUT FREQUENCY**



**Figure 29.**

**SPURIOUS-FREE DYNAMIC RANGE AND  
TOTAL HARMONIC DISTORTION  
vs  
INPUT FREQUENCY**

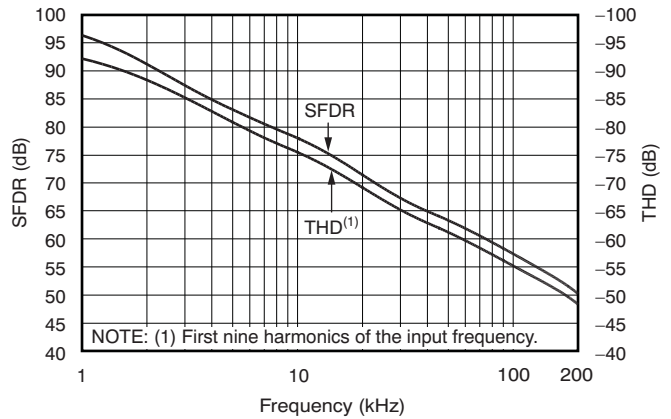

**Figure 30.**

**EFFECTIVE NUMBER OF BITS  
vs  
INPUT FREQUENCY**

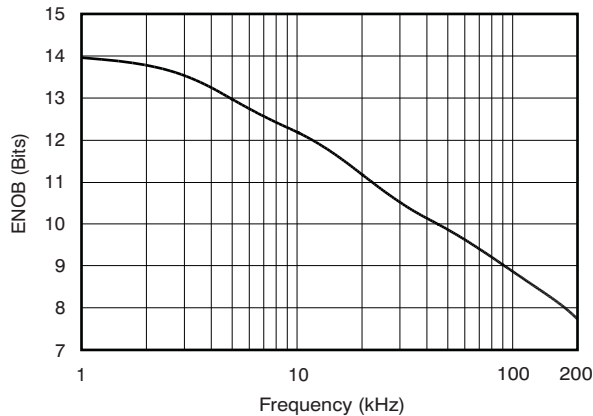

**Figure 31.**

**CHANGE IN SIGNAL-TO-NOISE + DISTORTION  
vs  
TEMPERATURE**

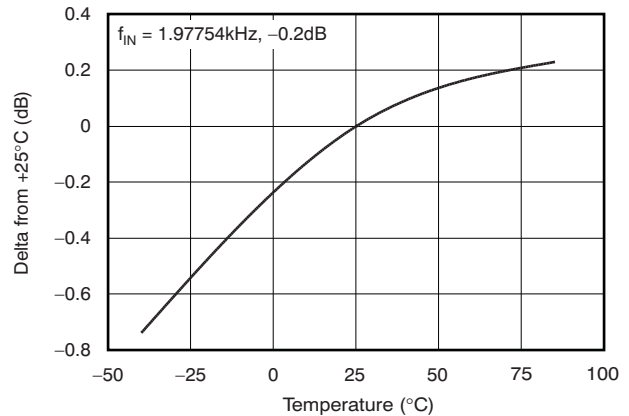

**Figure 32.**

**TYPICAL CHARACTERISTICS:  $V_{DD} = +2.7V$  (continued)**

At  $T_A = +25^\circ C$ ,  $V_{DD} = +2.7V$ ,  $V_{REF} = +2.5V$ .  $f_{SAMPLE} = 200kHz$ ,  $f_{CLK} = 24 \times f_{SAMPLE}$ , unless otherwise noted.

**SIGNAL-TO-NOISE + DISTORTION  
vs  
INPUT LEVEL**

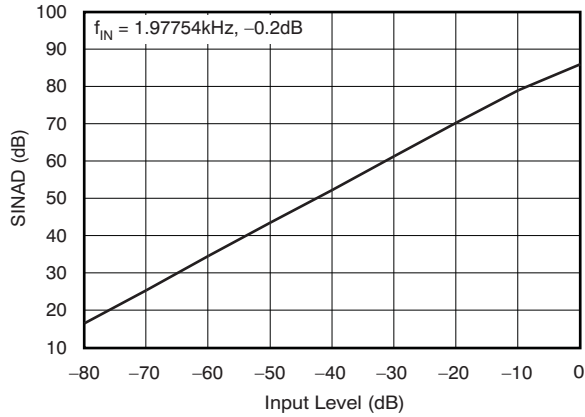

Figure 33.

**SUPPLY CURRENT  
vs  
TEMPERATURE**

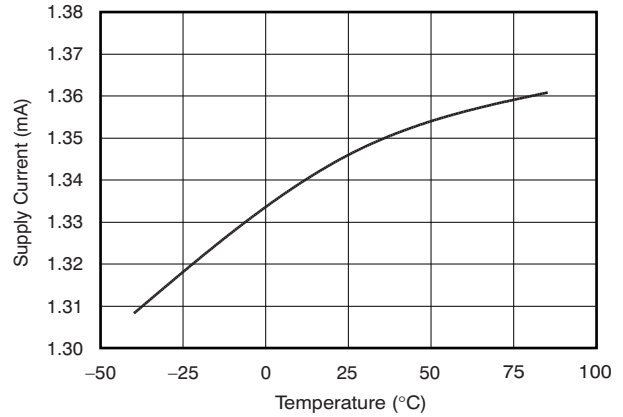

Figure 34.

**SUPPLY CURRENT  
vs  
SAMPLING RATE**

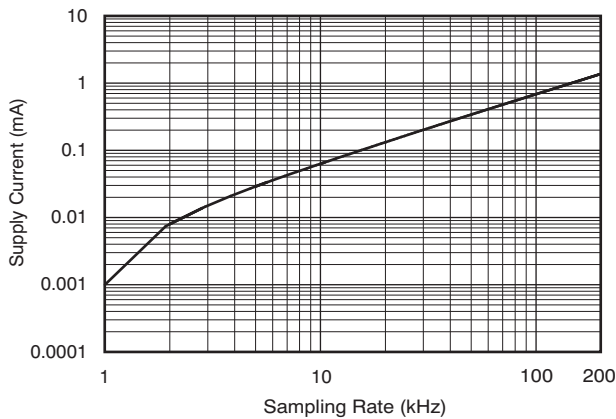

Figure 35.

**REFERENCE CURRENT  
vs  
SAMPLING RATE**

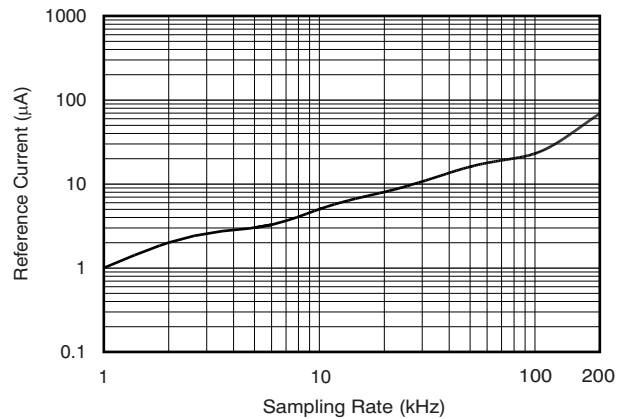

Figure 36.

**OUTPUT CODE HISTOGRAM FOR A DC INPUT  
(8192 Conversions)**

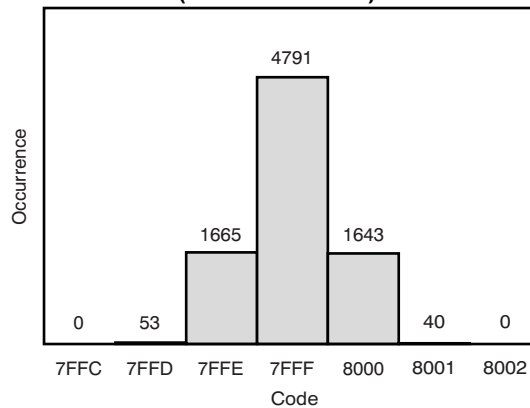

Figure 37.

## THEORY OF OPERATION

The ADS8326 is a classic Successive Approximation Register (SAR) Analog-to-Digital (A/D) converter. The architecture is based on capacitive redistribution that inherently includes a sample-and-hold function. The converter is fabricated on a 0.6 $\mu$  CMOS process. The architecture and process allow the ADS8326 to acquire and convert an analog signal at up to 250,000 conversions per second while consuming less than 10mW from  $V_{DD}$ .

Differential linearity for the ADS8326 is factory-adjusted via a package-level trim procedure. The state of the trim elements is stored in non-volatile memory and is continuously updated after each acquisition cycle, just prior to the start of the successive approximation operation. This process ensures that one complete conversion cycle always returns the part to its factory-adjusted state in the event of a power interruption.

The ADS8326 requires an external reference, an external clock, and a single power source ( $V_{DD}$ ). The external reference can be any voltage between 0.1V and  $V_{DD}$ . The value of the reference voltage directly sets the range of the analog input. The reference input current depends on the conversion rate of the ADS8326.

The external clock can vary between 24kHz (1kHz throughput) and 6.0MHz (250kHz throughput). The duty cycle of the clock is essentially unimportant, as long as the minimum high and low times are at least 200ns ( $V_{DD} = 4.75V$  or greater). The minimum clock frequency is set by the leakage on the internal capacitors to the ADS8326.

The analog input is provided to two input pins: +IN and -IN. When a conversion is initiated, the differential input on these pins is sampled on the internal capacitor array. While a conversion is in progress, both inputs are disconnected from any internal function.

The digital result of the conversion is clocked out by the DCLOCK input and is provided serially (most significant bit first) on the  $D_{OUT}$  pin.

The digital data that is provided on the  $D_{OUT}$  pin is for the conversion currently in progress—there is no pipeline delay. It is possible to continue to clock the ADS8326 after the conversion is complete and to obtain the serial data least significant bit first. See the [Timing Information](#) section for more information.

### ANALOG INPUT

The analog input of ADS8326 is differential. The +IN and –IN input pins allow for a differential input signal. The amplitude of the input is the difference between the +IN and –IN input, or (+IN) – (–IN). Unlike some converters of this type, the –IN input is not resampled later in the conversion cycle. When the converter goes into Hold mode or conversion, the voltage difference between +IN and –IN is captured on the internal capacitor array.

The range of the –IN input is limited to –0.3V to +0.5V. As a result of this limitation, the differential input could be used to reject signals that are common to both inputs in the specified range. Thus, the –IN input is best used to sense a remote signal ground that may move slightly with respect to the local ground potential.

The general method for driving the analog input of the ADS8326 is shown in Figure 38 and Figure 40. The –IN input is held at the common-mode voltage. The +IN input swings from –IN (or common-mode voltage) to –IN + V<sub>REF</sub> (or common-mode voltage + V<sub>REF</sub>), and the peak-to-peak amplitude is +V<sub>REF</sub>. The value of V<sub>REF</sub> determines the range over which the common-mode voltage may vary, as shown in Figure 39. Figure 6 and Figure 7 (+5V), and Figure 25 and Figure 26 (+2.7V) illustrate the typical change in gain and offset as a function of the common-mode voltage applied to the –IN pin.

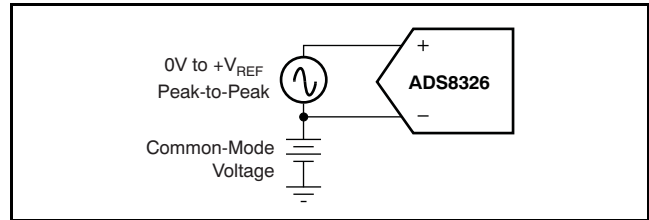

Figure 38. Methods of Driving the ADS8326

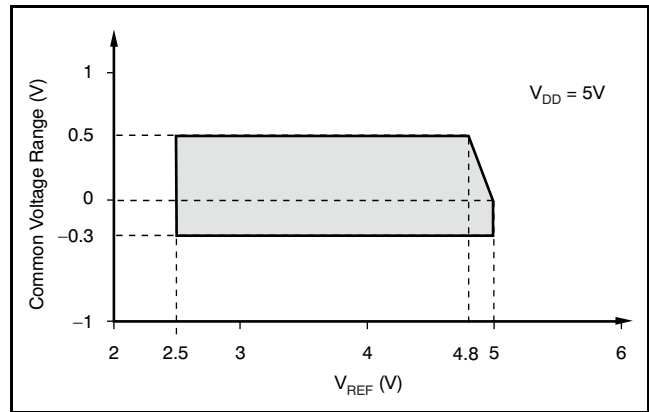
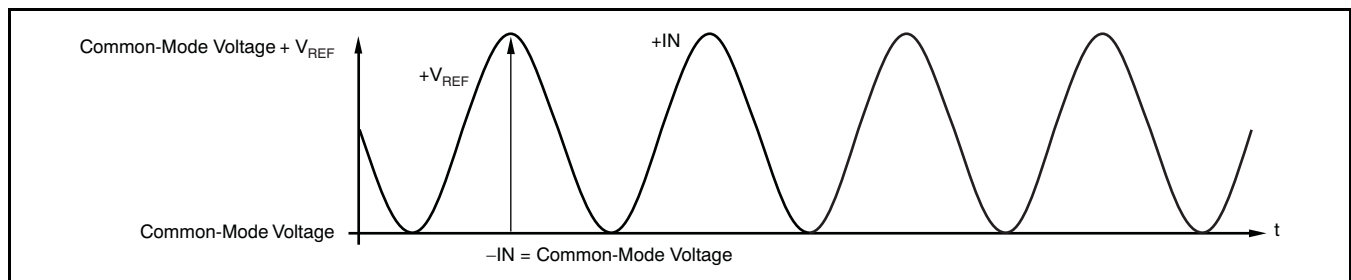

Figure 39. +IN Analog Input: Common-Mode Voltage Range vs V<sub>REF</sub>



NOTE: The maximum differential voltage between +IN and –IN of the ADS8326 is V<sub>REF</sub>. See Figure 39 for a further explanation of the common-mode voltage range for differential inputs.

Figure 40. Differential Input Mode of the ADS8326

The input current required by the analog inputs depends on a number of factors: sample rate, input voltage, source impedance, and power-down mode. Essentially, the current into the ADS8326 charges the internal capacitor array during the sample period. After this capacitance has been fully charged, there is no further input current. The source of the analog input voltage must be able to charge the input capacitance (48pF) to a 16-bit settling level within 4.5 clock cycles (0.750μs). When the converter goes into Hold mode, or while it is in Power-Down mode, the input impedance is greater than 1GΩ.

Care must be taken regarding the absolute analog input voltage. To maintain the linearity of the converter, the –IN input should not drop below GND – 0.3V or exceed GND + 0.5V. The +IN input should always remain within the range of GND – 0.3V to  $V_{DD} + 0.3V$ , or –IN to  $-IN + V_{REF}$ , whichever limit is reached first. Outside of these ranges, the converter linearity may not meet specifications. To minimize noise, low bandwidth input signals with low-pass filters should be used. In each case, care should be taken to ensure that the output impedance of the sources driving the +IN and –IN inputs are matched. Often, a small capacitor (20pF) between the positive and negative inputs helps to match their impedance. To obtain maximum performance from the ADS8326, the input circuit from [Figure 41](#) is recommended.

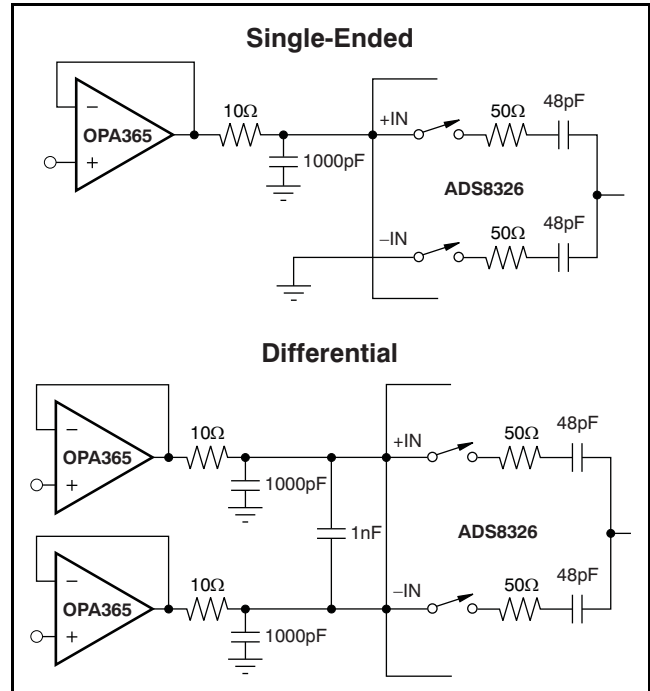

**Figure 41. Single-Ended and Differential Methods of Interfacing the ADS8326**

## REFERENCE INPUT

The external reference sets the analog input range. The ADS8326 operates with a reference in the range of 0.1V to  $V_{DD}$ . There are several important implications to this.

As the reference voltage is reduced, the analog voltage weight of each digital output code is reduced. This is often referred to as the least significant bit (LSB) size and is equal to the reference voltage divided by 65,536. This means that any offset or gain error inherent in the A/D converter will appear to increase (in terms of LSB size) as the reference voltage is reduced. For a reference voltage of 2.5V, the value of the LSB is 38.15 $\mu$ V, and for a reference voltage of 5V, the LSB is 76.3 $\mu$ V.

The noise inherent in the converter will also appear to increase with a lower LSB size. With a 5V reference, the internal noise of the converter typically contributes only 1.5LSB peak-to-peak of potential error to the output code. When the external reference is 2.5V, the potential error contribution from the internal noise will be two times larger (3LSB). The errors arising from the internal noise are Gaussian in nature and can be reduced by averaging consecutive conversion results.

For more information regarding noise, see [Figure 15](#), *Peak-to-Peak Noise for a DC Input vs Reference Voltage*. Note that the Effective Number Of Bits (ENOB) figure is calculated based on the converter signal-to-(noise + distortion) ratio with a 1kHz, 0dB input signal. SINAD is related to ENOB as follows:

$$\text{SINAD} = 6.02 \times \text{ENOB} + 1.76$$

With lower reference voltages, extra care should be taken to provide a clean layout including adequate bypassing, a clean power supply, a low-noise reference, and a low-noise input signal. Due to the lower LSB size, the converter is also more sensitive to external sources of error, such as nearby digital signals and electromagnetic interference.

The equivalent input circuit for the reference voltage is presented in [Figure 42](#). During the conversion process, an equivalent capacitor of 24pF is switched on. To obtain optimum performance from the ADS8326, special care must be taken in designing the interface circuit to the reference input pin. To ensure a stable reference voltage, a 47 $\mu$ F tantalum capacitor with low ESR should be connected as close as possible to the input pin. If a high output impedance reference source is used, an additional operational amplifier with a current-limiting resistor must be placed in front of the capacitors.

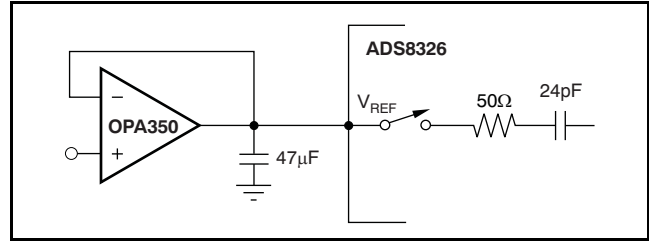

**Figure 42. Input Reference Circuit and Interface**

When the ADS8326 is in Power-Down mode, the input resistance of the reference pin will have a value of 5G $\Omega$ . Since the input capacitors must be recharged before the next conversion starts, an operational amplifier with good dynamic characteristics must be used to buffer the reference input.

### Noise

The transition noise of the ADS8326 itself is extremely low, as shown in [Figure 20](#) (+5V) and [Figure 37](#) (+2.7V); it is much lower than competing A/D converters. These histograms were generated by applying a low-noise DC input and initiating 8192 conversions. The digital output of the A/D converter will vary in output code because of the internal noise of the ADS8326. This is true for all 16-bit, SAR-type A/D converters. Using a histogram to plot the output codes, the distribution should appear bell-shaped with the peak of the bell curve representing the nominal code for the input value. The  $\pm 1\sigma$ ,  $\pm 2\sigma$ , and  $\pm 3\sigma$  distributions will represent 68.3%, 95.5%, and 99.7%, respectively, of all codes. The transition noise can be calculated by dividing the number of codes measured by 6, which yields the  $\pm 3\sigma$  distribution, or 99.7%, of all codes. Statistically, up to three codes could fall outside the distribution when executing 1000 conversions. The ADS8326, with < 3 output codes for the  $\pm 3\sigma$  distribution, yields <  $\pm 0.5$ LSB of transition noise. Remember, to achieve this low-noise performance, the peak-to-peak noise of the input signal and reference must be < 50 $\mu$ V.

### Averaging

The noise of the A/D converter can be compensated by averaging the digital codes. By averaging conversion results, transition noise is reduced by a factor of  $1/\sqrt{n}$ , where  $n$  is the number of averages. For example, averaging four conversion results reduces the transition noise from  $\pm 0.5$ LSB to  $\pm 0.25$ LSB. Averaging should only be used for input signals with frequencies near DC.

For AC signals, a digital filter can be used to low-pass filter and decimate the output codes. This works in a similar manner to averaging; for every decimation by 2, the signal-to-noise ratio improves by 3dB.

## DIGITAL INTERFACE

### Signal Levels

The ADS8326 has a wide range of power-supply voltage. The A/D converter, as well as the digital interface circuit, is designed to accept and operate from 2.7V up to 5.5V. This voltage range will accommodate different logic levels. When the ADS8326 power-supply voltage is in the range of 4.5V to 5.5V (5V logic level), the ADS8326 can be connected directly to another 5V, CMOS-integrated circuit. When the ADS8326 power-supply voltage is in the range of 2.7V to 3.6V (3V logic level), the ADS8326 can be connected directly to another 3.3V LVCMOS integrated circuit.

### Serial Interface

The ADS8326 communicates with microprocessors and other digital systems via a synchronous 3-wire serial interface, as illustrated in the [Timing Information](#) section. The DCLOCK signal synchronizes the data transfer, with each bit being transmitted on the falling edge of DCLOCK. Most receiving systems will capture the bitstream on the rising edge of DCLOCK. However, if the minimum hold time for D<sub>OUT</sub> is acceptable, the system can use the falling edge of DCLOCK to capture each bit.

A falling  $\overline{CS}$  signal initiates the conversion and data transfer. The first 4.5 to 5.0 clock periods of the conversion cycle are used to sample the input signal. After the fifth falling DCLOCK edge, D<sub>OUT</sub> is enabled and will output a low value for one clock period. For the next 16 DCLOCK periods, D<sub>OUT</sub> will output the conversion result, most significant bit first. After the least significant bit (B0) has been output, subsequent clocks will repeat the output data, but in a least significant bit first format.

After the most significant bit (B15) has been repeated, D<sub>OUT</sub> will tri-state. Subsequent clocks will have no effect on the converter. A new conversion is initiated only when  $\overline{CS}$  has been taken high and returned low.

### Data Format

The output data from the ADS8326 is in Straight Binary format, as shown in [Figure 43](#). This figure represents the ideal output code for a given input voltage and does not include the effects of offset, gain error, or noise.

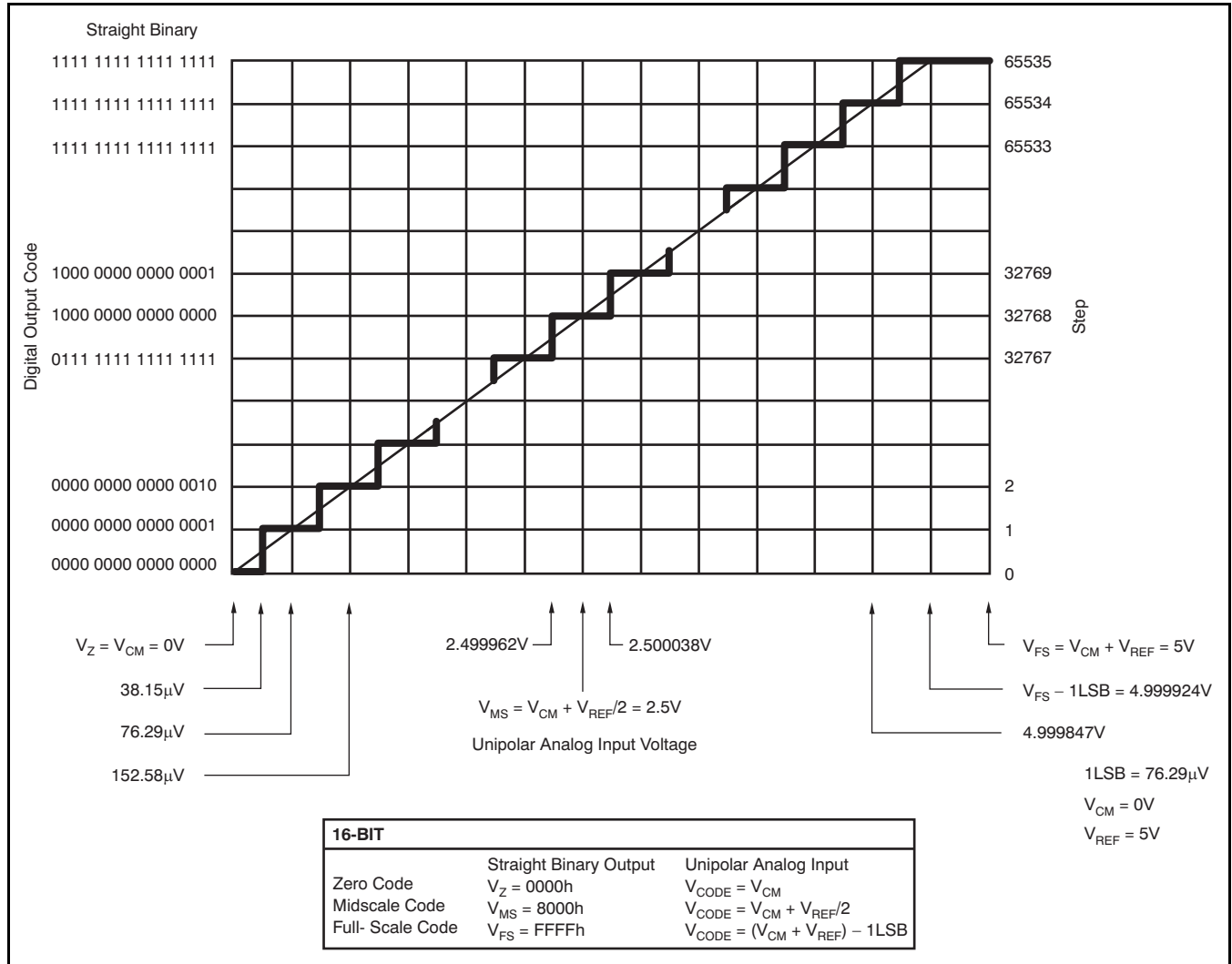

Figure 43. Ideal Conversion Characteristics (Conditions:  $V_{CM} = 0V$ ,  $V_{REF} = 5V$ )

## POWER DISSIPATION

The architecture of the converter, the semiconductor fabrication process, and a careful design allow the ADS8326 to convert at up to a 250kHz rate while requiring very little power. However, for the absolute lowest power dissipation, there are several things to keep in mind.

The power dissipation of the ADS8326 scales directly with conversion rate. Therefore, the first step to achieving the lowest power dissipation is to find the lowest conversion rate that will satisfy the requirements of the system.

In addition, the ADS8326 goes into Power-Down mode under two conditions: when the conversion is complete and whenever  $\overline{CS}$  is high (see the [Timing Information](#) section). Ideally, each conversion should occur as quickly as possible, preferably at a 6.0MHz clock rate. This way, the converter spends the longest possible time in Power-Down mode. This is very important because the converter not only uses power on each DCLOCK transition (as is typical for digital CMOS components), but also uses some current for the analog circuitry, such as the comparator. The analog section dissipates power continuously until Power-Down mode is entered.

[Figure 17](#) and [Figure 18](#) (+5V), and [Figure 35](#) and [Figure 36](#) illustrate the current consumption of the ADS8326 versus sample rate. For these graphs, the converter is clocked at maximum speed regardless of the sample rate.  $\overline{CS}$  is held high during the remaining sample period.

There is an important distinction between the power-down mode that is entered after a conversion is complete and the full power-down mode that is enabled when  $\overline{CS}$  is high.  $\overline{CS}$  low will only shut down the analog section. The digital section is completely shut down only when  $\overline{CS}$  is high. Thus, if  $\overline{CS}$  is left low at the end of a conversion, and the converter is continually clocked, the power consumption will not be as low as when  $\overline{CS}$  is high.

## Short Cycling

Another way to save power is to use the  $\overline{CS}$  signal to short-cycle the conversion. The ADS8326 places the latest data bit on the  $D_{OUT}$  line as it is generated; therefore, the converter can easily be short-cycled. This term means that the conversion can be terminated at any time. For example, if only 14 bits of the conversion result are needed, then the conversion can be terminated (by pulling  $\overline{CS}$  high) after the 14th bit has been clocked out.

This technique can also be used to lower the power dissipation (or to increase the conversion rate) in those applications where an analog signal is being monitored until some condition becomes true. For example, if the signal is outside a predetermined range, the full 16-bit conversion result may not be needed. If so, the conversion can be terminated after the first  $n$  bits, where  $n$  might be as low as 3 or 4. This results in lower power dissipation in both the converter and the rest of the system because they spend more time in Power-Down mode.

## POWER-ON RESET

The ADS8326 bias circuit is self-starting. There may be a static current (approximately 1.5mA with  $V_{DD} = 5V$ ) after power-on, unless the circuit is powered down. It is recommended to run a single test conversion (configured the same as any regular conversion) after the power supply reaches at least 2.4V to ensure the device is put into power-down mode.

## LAYOUT

For optimum performance, care should be taken with the physical layout of the ADS8326 circuitry. This is particularly true if the reference voltage is low and/or the conversion rate is high. At a 250kHz conversion rate, the ADS8326 makes a bit decision every 167ns. That is, for each subsequent bit decision, the digital output must be updated with the results of the last bit decision, the capacitor array appropriately switched and charged, and the input to the comparator settled to a 16-bit level, all within one clock cycle.

The basic SAR architecture is sensitive to spikes on the power supply, reference, and ground connections that occur just prior to latching the comparator output. Thus, during any single conversion for an  $n$ -bit SAR converter, there are  $n$  windows in which large external transient voltages can easily affect the conversion result. Such spikes might originate from switching power supplies, digital logic, and high-power devices, to name a few potential sources. This particular source of error can be very difficult to track down if the glitch is almost synchronous to the converter DCLOCK signal because the phase difference between the two changes with time and temperature, causing sporadic misoperation.

With this in mind, power to the ADS8326 should be clean and well-bypassed. A 0.1 $\mu$ F ceramic bypass capacitor should be placed as close as possible to the ADS8326 package. In addition, a 1 $\mu$ F to 10 $\mu$ F capacitor and a 5 $\Omega$  or 10 $\Omega$  series resistor may be used to low-pass filter a noisy supply.

The reference should be similarly bypassed with a 47 $\mu$ F capacitor. Again, a series resistor and large capacitor can be used to low-pass filter the reference voltage. If the reference voltage originates from an op amp, make sure that the op amp can drive the bypass capacitor without oscillation (the series

resistor can help in this case). Keep in mind that while the ADS8326 draws very little current from the reference on average, there are still instantaneous current demands placed on the external input and reference circuitry.

Texas Instruments' [OPA365](#) op amp provides optimum performance for buffering the signal inputs; the [OPA350](#) can be used to effectively buffer the reference input.

Also, keep in mind that the ADS8326 offers no inherent rejection of noise or voltage variation in regards to the reference input. This is of particular concern when the reference input is tied to the power supply. Any noise and ripple from the supply will appear directly in the digital results. While high-frequency noise can be filtered out, as described in the previous paragraph, voltage variation resulting from the line frequency (50Hz or 60Hz) can be difficult to remove.

The GND pin on the ADS8326 should be placed on a clean ground point. In many cases, this will be the analog ground. Avoid connecting the GND pin too close to the grounding point for a microprocessor, microcontroller, or digital signal processor. If needed, run a ground trace directly from the converter to the power-supply connection point. The ideal layout will include an analog ground plane for the converter and associated analog circuitry.

APPLICATION CIRCUITS

Figure 44 and Figure 45 show two examples of a basic data acquisition system. The ADS8326 input range is connected to 2.5V or 4.096V. The 5Ω resistor and 1μF to 10μF capacitor filters the microcontroller noise on the supply, as well as any

high-frequency noise from the supply itself. The exact values should be picked such that the filter provides adequate rejection of noise. Operational amplifiers and voltage reference are connected to analog power supply, AV<sub>DD</sub>.

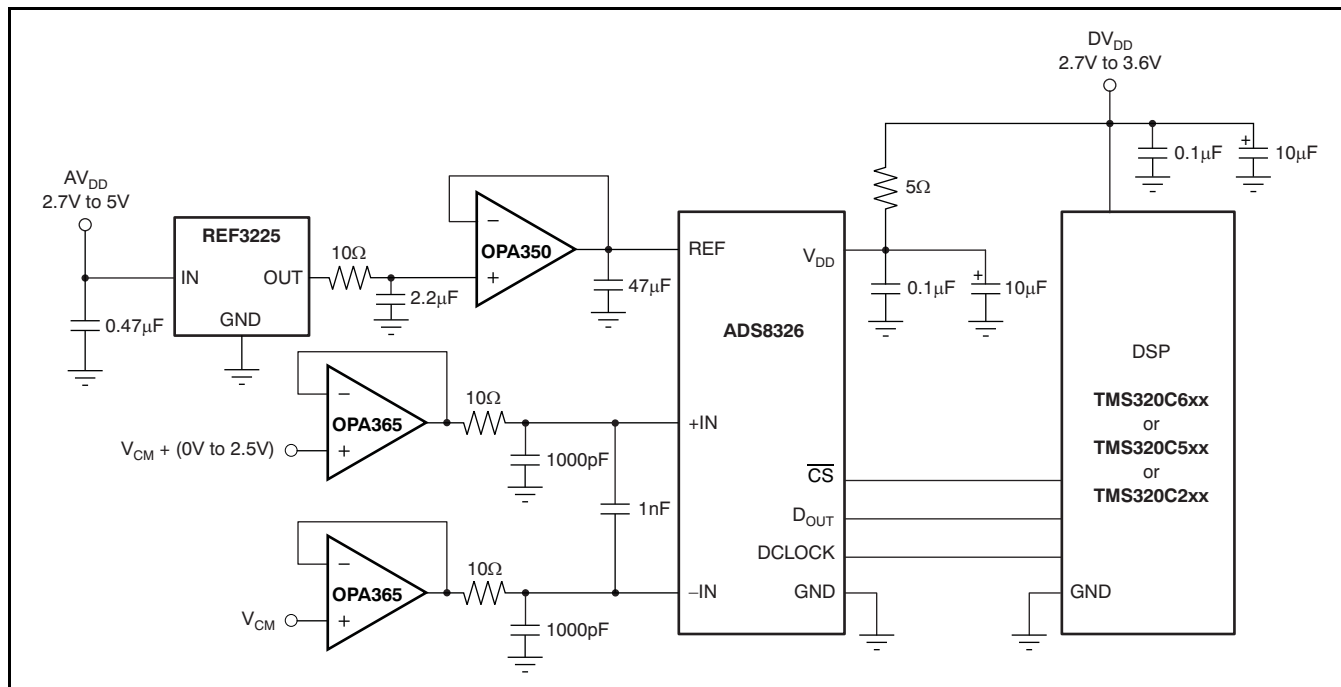

Figure 44. Basic Data Acquisition System: Example 1

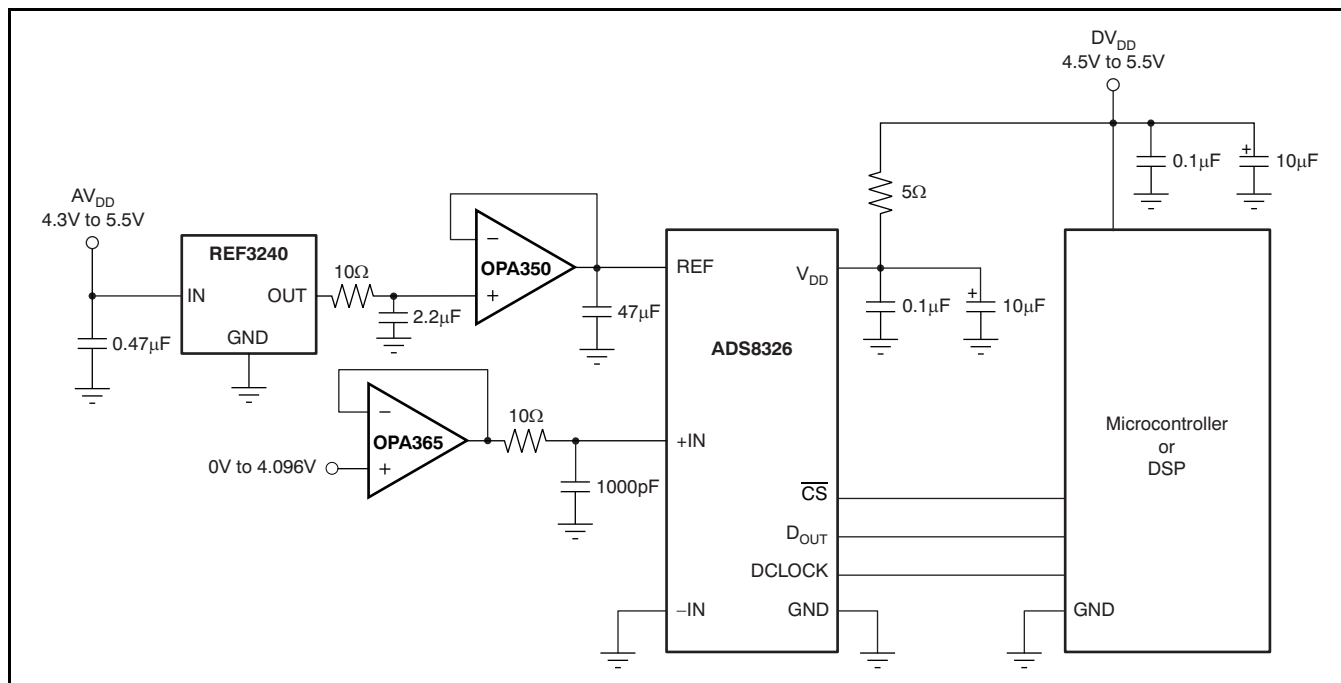

Figure 45. Basic Data Acquisition System: Example 2

## REVISION HISTORY

NOTE: Page numbers for previous revisions may differ from page numbers in the current version.

<b>Changes from Revision B (May, 2008) to Revision C</b>	<b>Page</b>
• Released SON-8 package; changed statements regarding SON-8 package availability .....	1
• Deleted footnote about SON-8 package availability .....	2
• Deleted footnote about SON-8 package availability .....	3
• Deleted footnote about SON-8 package availability .....	7

<b>Changes from Revision A (August, 2007) to Revision B</b>	<b>Page</b>
• Changed SON-8 package availability to Q3, 2008 .....	1
• Changed y-axis unit in <a href="#">Figure 35</a> from $\mu\text{A}$ to mA .....	18
• Added <i>Power-On Reset</i> section .....	25

**PACKAGING INFORMATION**

Orderable Device	Status (1)	Package Type	Package Drawing	Pins	Package Qty	Eco Plan (2)	Lead/Ball Finish (6)	MSL Peak Temp (3)	Op Temp (°C)	Device Marking (4/5)	Samples
ADS8326IBDGKR	ACTIVE	VSSOP	DGK	8	2500	Green (RoHS & no Sb/Br)	CU NIPDAUAG	Level-2-260C-1 YEAR	-40 to 85	D26	<a href="#">Samples</a>
ADS8326IBDGKT	ACTIVE	VSSOP	DGK	8	250	Green (RoHS & no Sb/Br)	CU NIPDAUAG	Level-2-260C-1 YEAR	-40 to 85	D26	<a href="#">Samples</a>
ADS8326IBDGKTG4	ACTIVE	VSSOP	DGK	8	250	Green (RoHS & no Sb/Br)	CU NIPDAUAG	Level-2-260C-1 YEAR	-40 to 85	D26	<a href="#">Samples</a>
ADS8326IBDRBR	ACTIVE	SON	DRB	8	3000	Green (RoHS & no Sb/Br)	CU NIPDAU	Level-2-260C-1 YEAR	-40 to 85	D26	<a href="#">Samples</a>
ADS8326IBDRBT	ACTIVE	SON	DRB	8	250	Green (RoHS & no Sb/Br)	CU NIPDAU	Level-2-260C-1 YEAR	-40 to 85	D26	<a href="#">Samples</a>
ADS8326IDGKR	ACTIVE	VSSOP	DGK	8	2500	Green (RoHS & no Sb/Br)	CU NIPDAUAG	Level-2-260C-1 YEAR	-40 to 85	D26	<a href="#">Samples</a>
ADS8326IDGKT	ACTIVE	VSSOP	DGK	8	250	Green (RoHS & no Sb/Br)	CU NIPDAUAG	Level-2-260C-1 YEAR	-40 to 85	D26	<a href="#">Samples</a>
ADS8326IDRBR	ACTIVE	SON	DRB	8	3000	Green (RoHS & no Sb/Br)	CU NIPDAU	Level-2-260C-1 YEAR	-40 to 85	D26	<a href="#">Samples</a>
ADS8326IDRBT	ACTIVE	SON	DRB	8	250	Green (RoHS & no Sb/Br)	CU NIPDAU	Level-2-260C-1 YEAR	-40 to 85	D26	<a href="#">Samples</a>

(1) The marketing status values are defined as follows:

**ACTIVE:** Product device recommended for new designs.

**LIFEBUY:** TI has announced that the device will be discontinued, and a lifetime-buy period is in effect.

**NRND:** Not recommended for new designs. Device is in production to support existing customers, but TI does not recommend using this part in a new design.

**PREVIEW:** Device has been announced but is not in production. Samples may or may not be available.

**OBSOLETE:** TI has discontinued the production of the device.

(2) **RoHS:** TI defines "RoHS" to mean semiconductor products that are compliant with the current EU RoHS requirements for all 10 RoHS substances, including the requirement that RoHS substance do not exceed 0.1% by weight in homogeneous materials. Where designed to be soldered at high temperatures, "RoHS" products are suitable for use in specified lead-free processes. TI may reference these types of products as "Pb-Free".

**RoHS Exempt:** TI defines "RoHS Exempt" to mean products that contain lead but are compliant with EU RoHS pursuant to a specific EU RoHS exemption.

**Green:** TI defines "Green" to mean the content of Chlorine (Cl) and Bromine (Br) based flame retardants meet JS709B low halogen requirements of <=1000ppm threshold. Antimony trioxide based flame retardants must also meet the <=1000ppm threshold requirement.

(3) MSL, Peak Temp. - The Moisture Sensitivity Level rating according to the JEDEC industry standard classifications, and peak solder temperature.

(4) There may be additional marking, which relates to the logo, the lot trace code information, or the environmental category on the device.

(5) Multiple Device Markings will be inside parentheses. Only one Device Marking contained in parentheses and separated by a "~" will appear on a device. If a line is indented then it is a continuation of the previous line and the two combined represent the entire Device Marking for that device.

(6) Lead/Ball Finish - Orderable Devices may have multiple material finish options. Finish options are separated by a vertical ruled line. Lead/Ball Finish values may wrap to two lines if the finish value exceeds the maximum column width.

**Important Information and Disclaimer:**The information provided on this page represents TI's knowledge and belief as of the date that it is provided. TI bases its knowledge and belief on information provided by third parties, and makes no representation or warranty as to the accuracy of such information. Efforts are underway to better integrate information from third parties. TI has taken and continues to take reasonable steps to provide representative and accurate information but may not have conducted destructive testing or chemical analysis on incoming materials and chemicals. TI and TI suppliers consider certain information to be proprietary, and thus CAS numbers and other limited information may not be available for release.

In no event shall TI's liability arising out of such information exceed the total purchase price of the TI part(s) at issue in this document sold by TI to Customer on an annual basis.

## TAPE AND REEL INFORMATION



### QUADRANT ASSIGNMENTS FOR PIN 1 ORIENTATION IN TAPE



\*All dimensions are nominal

Device	Package Type	Package Drawing	Pins	SPQ	Reel Diameter (mm)	Reel Width W1 (mm)	A0 (mm)	B0 (mm)	K0 (mm)	P1 (mm)	W (mm)	Pin1 Quadrant
ADS8326IBDGKR	VSSOP	DGK	8	2500	330.0	12.4	5.3	3.4	1.4	8.0	12.0	Q1
ADS8326IBDGKT	VSSOP	DGK	8	250	180.0	12.4	5.3	3.4	1.4	8.0	12.0	Q1
ADS8326IBDRBR	SON	DRB	8	3000	330.0	12.4	3.3	3.3	1.1	8.0	12.0	Q2
ADS8326IBDRBT	SON	DRB	8	250	180.0	12.4	3.3	3.3	1.1	8.0	12.0	Q2
ADS8326IDGKR	VSSOP	DGK	8	2500	330.0	12.4	5.3	3.4	1.4	8.0	12.0	Q1
ADS8326IDGKT	VSSOP	DGK	8	250	180.0	12.4	5.3	3.4	1.4	8.0	12.0	Q1
ADS8326IDRBR	SON	DRB	8	3000	330.0	12.4	3.3	3.3	1.1	8.0	12.0	Q2
ADS8326IDRBT	SON	DRB	8	250	180.0	12.4	3.3	3.3	1.1	8.0	12.0	Q2

**TAPE AND REEL BOX DIMENSIONS**

\*All dimensions are nominal

Device	Package Type	Package Drawing	Pins	SPQ	Length (mm)	Width (mm)	Height (mm)
ADS8326IBDGKR	VSSOP	DGK	8	2500	350.0	350.0	43.0
ADS8326IBDGKT	VSSOP	DGK	8	250	210.0	185.0	35.0
ADS8326IBDRBR	SON	DRB	8	3000	350.0	350.0	43.0
ADS8326IBDRBT	SON	DRB	8	250	210.0	185.0	35.0
ADS8326IDGKR	VSSOP	DGK	8	2500	350.0	350.0	43.0
ADS8326IDGKT	VSSOP	DGK	8	250	210.0	185.0	35.0
ADS8326IDRBR	SON	DRB	8	3000	350.0	350.0	43.0
ADS8326IDRBT	SON	DRB	8	250	210.0	185.0	35.0

**DRB 8**

**GENERIC PACKAGE VIEW**

**VSON - 1 mm max height**

PLASTIC SMALL OUTLINE - NO LEAD



Images above are just a representation of the package family, actual package may vary.  
Refer to the product data sheet for package details.

4203482/L

DRB0008B



# PACKAGE OUTLINE

VSON - 1 mm max height

PLASTIC SMALL OUTLINE - NO LEAD

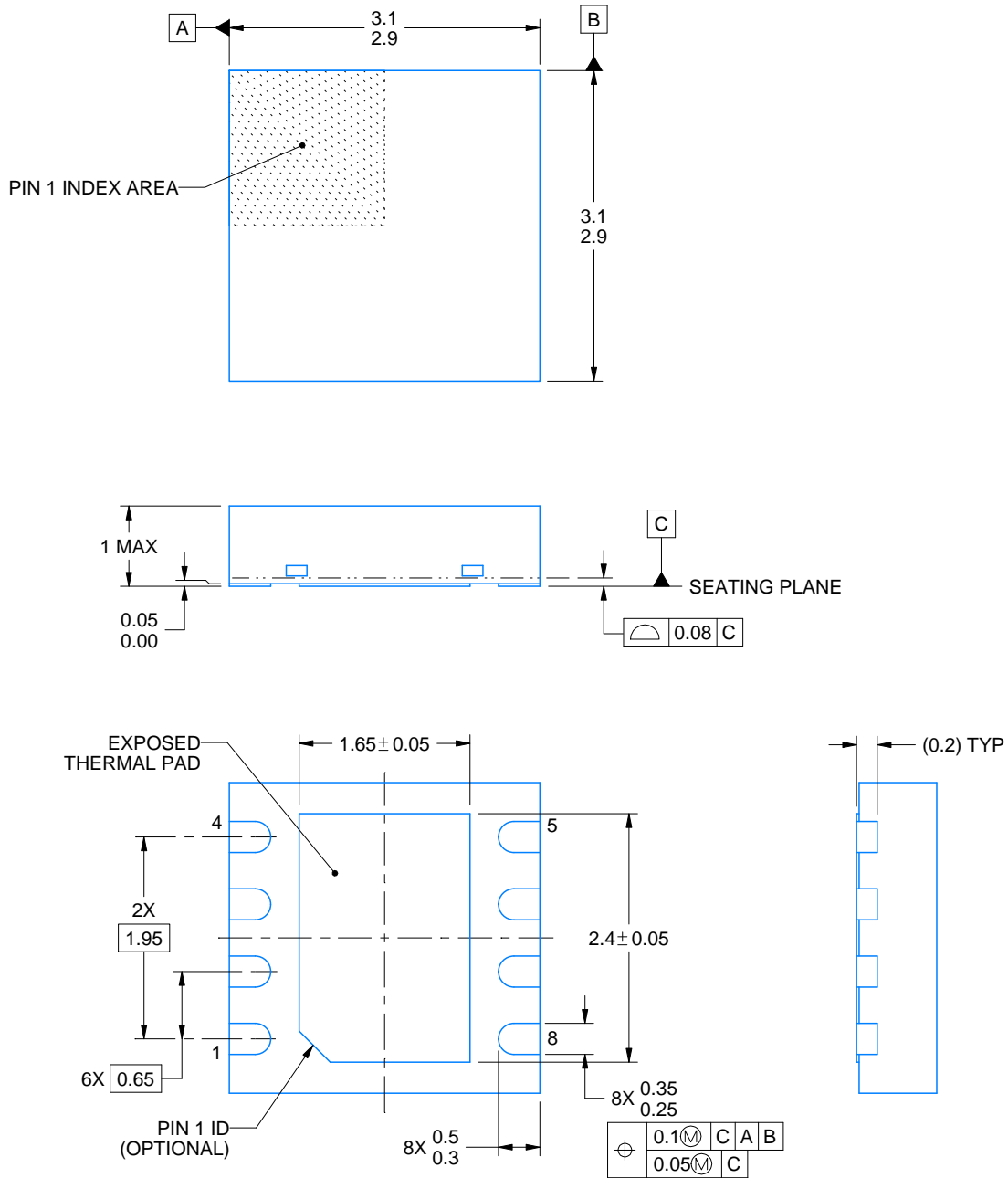

4218876/A 12/2017

**NOTES:**

1. All linear dimensions are in millimeters. Any dimensions in parenthesis are for reference only. Dimensioning and tolerancing per ASME Y14.5M.
2. This drawing is subject to change without notice.
3. The package thermal pad must be soldered to the printed circuit board for thermal and mechanical performance.

# EXAMPLE BOARD LAYOUT

DRB0008B

VSON - 1 mm max height

PLASTIC SMALL OUTLINE - NO LEAD



LAND PATTERN EXAMPLE  
SCALE:20X



SOLDER MASK DETAILS

4218876/A 12/2017

NOTES: (continued)

4. This package is designed to be soldered to a thermal pad on the board. For more information, see Texas Instruments literature number SLUA271 ([www.ti.com/lit/sluea271](http://www.ti.com/lit/sluea271)).
5. Vias are optional depending on application, refer to device data sheet. If any vias are implemented, refer to their locations shown on this view. It is recommended that vias under paste be filled, plugged or tented.

# EXAMPLE STENCIL DESIGN

DRB0008B

VSON - 1 mm max height

PLASTIC SMALL OUTLINE - NO LEAD



SOLDER PASTE EXAMPLE  
BASED ON 0.125 mm THICK STENCIL

EXPOSED PAD  
81% PRINTED SOLDER COVERAGE BY AREA  
SCALE:25X

4218876/A 12/2017

NOTES: (continued)

6. Laser cutting apertures with trapezoidal walls and rounded corners may offer better paste release. IPC-7525 may have alternate design recommendations.

DGK (S-PDSO-G8)

PLASTIC SMALL-OUTLINE PACKAGE

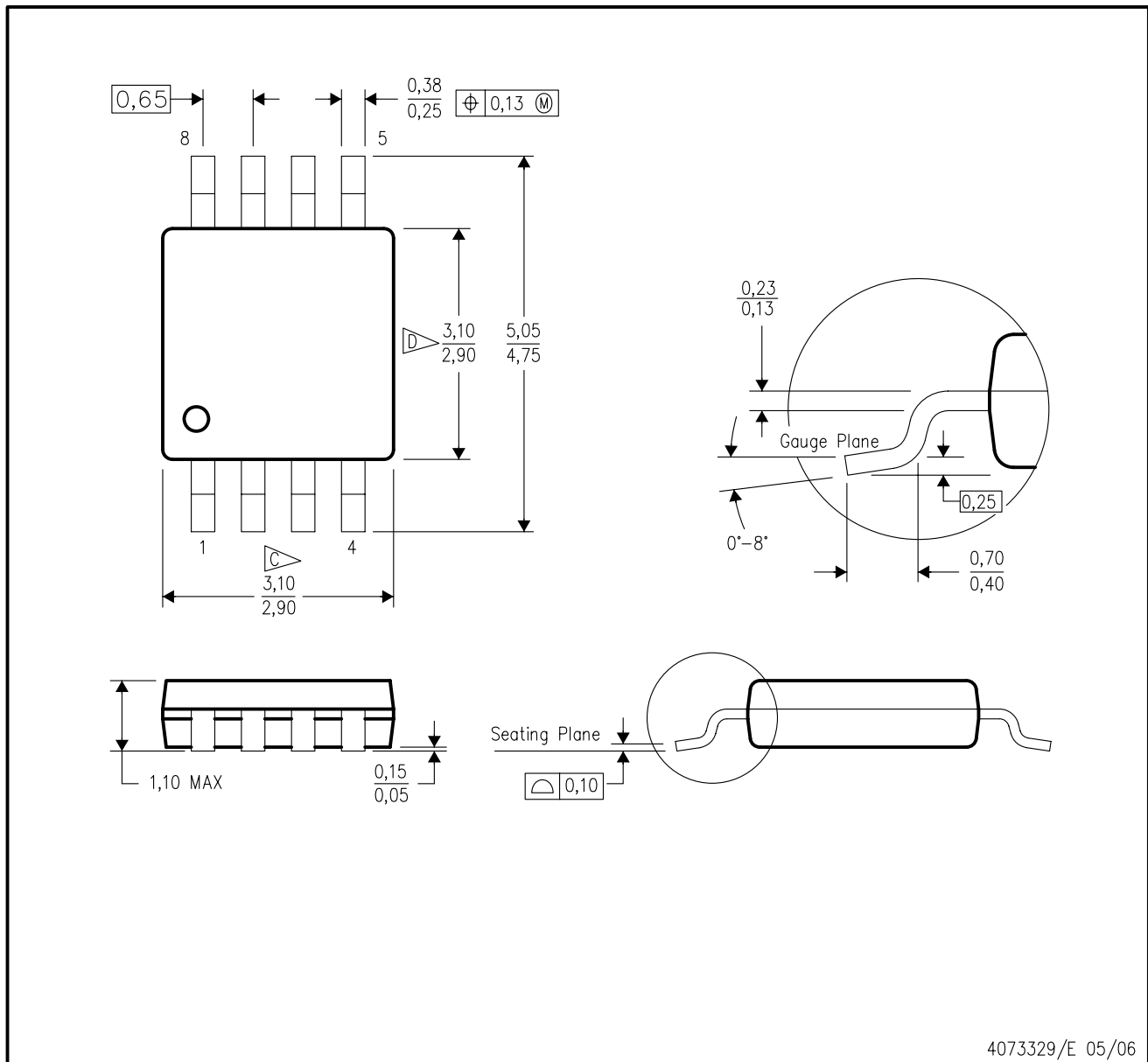

- NOTES:
- A. All linear dimensions are in millimeters.
  - B. This drawing is subject to change without notice.
  - C. Body length does not include mold flash, protrusions, or gate burrs. Mold flash, protrusions, or gate burrs shall not exceed 0.15 per end.
  - D. Body width does not include interlead flash. Interlead flash shall not exceed 0.50 per side.
  - E. Falls within JEDEC MO-187 variation AA, except interlead flash.



- NOTES:
- A. All linear dimensions are in millimeters.
  - B. This drawing is subject to change without notice.
  - C. Publication IPC-7351 is recommended for alternate designs.
  - D. Laser cutting apertures with trapezoidal walls and also rounding corners will offer better paste release. Customers should contact their board assembly site for stencil design recommendations. Refer to IPC-7525 for other stencil recommendations.
  - E. Customers should contact their board fabrication site for solder mask tolerances between and around signal pads.

## IMPORTANT NOTICE AND DISCLAIMER

TI PROVIDES TECHNICAL AND RELIABILITY DATA (INCLUDING DATASHEETS), DESIGN RESOURCES (INCLUDING REFERENCE DESIGNS), APPLICATION OR OTHER DESIGN ADVICE, WEB TOOLS, SAFETY INFORMATION, AND OTHER RESOURCES "AS IS" AND WITH ALL FAULTS, AND DISCLAIMS ALL WARRANTIES, EXPRESS AND IMPLIED, INCLUDING WITHOUT LIMITATION ANY IMPLIED WARRANTIES OF MERCHANTABILITY, FITNESS FOR A PARTICULAR PURPOSE OR NON-INFRINGEMENT OF THIRD PARTY INTELLECTUAL PROPERTY RIGHTS.

These resources are intended for skilled developers designing with TI products. You are solely responsible for (1) selecting the appropriate TI products for your application, (2) designing, validating and testing your application, and (3) ensuring your application meets applicable standards, and any other safety, security, or other requirements. These resources are subject to change without notice. TI grants you permission to use these resources only for development of an application that uses the TI products described in the resource. Other reproduction and display of these resources is prohibited. No license is granted to any other TI intellectual property right or to any third party intellectual property right. TI disclaims responsibility for, and you will fully indemnify TI and its representatives against, any claims, damages, costs, losses, and liabilities arising out of your use of these resources.

TI's products are provided subject to TI's Terms of Sale ([www.ti.com/legal/termsofsale.html](http://www.ti.com/legal/termsofsale.html)) or other applicable terms available either on [ti.com](http://ti.com) or provided in conjunction with such TI products. TI's provision of these resources does not expand or otherwise alter TI's applicable warranties or warranty disclaimers for TI products.

Mailing Address: Texas Instruments, Post Office Box 655303, Dallas, Texas 75265  
Copyright © 2019, Texas Instruments Incorporated

## Looking for pricing, stock, or lifecycle information?

Click below to explore more details on WIN SOURCE:

 [View ADS8326IBDRBT on WIN SOURCE](#)

 [Texas Instruments](#) Information

## Optimize Your Supply Chain with WIN SOURCE Solutions

-  Global Sourcing Solution
-  Obsolete Management
-  Cost Control Management
-  Shortage Management
-  Alternative Solution
-  Excess Inventory Management