



**THE DATASHEET OF  
ADS7866IDBVR**





## 1.2-V, 12-/10-/8-BIT, 200-KSPS/100-KSPS, MICRO-POWER, MINIATURE ANALOG-TO-DIGITAL CONVERTER WITH SERIAL INTERFACE

### FEATURES

- **Single 1.2-V to 3.6-V Supply Operation**
- **High Throughput**
  - 200/240/280KSPS for 12/10/8-Bit  $V_{DD} \geq 1.6$  V
  - 100/120/140KSPS for 12/10/8-Bit  $V_{DD} \geq 1.2$  V
- $\pm 1.5$ LSB INL, 12-Bit NMC (ADS7866)
- 71 dB SNR,  $-83$  dB THD at  $f_{IN} = 30$  kHz (ADS7866)
- **Synchronized Conversion with SCLK**
- **SPI Compatible Serial Interface**
- **No Pipeline Delays**
- **Low Power**
  - 1.39 mW Typ at 200 KSPS,  $V_{DD} = 3.6$  V
  - 0.39 mW Typ at 200 KSPS,  $V_{DD} = 1.6$  V
  - 0.22 mW Typ at 100 KSPS,  $V_{DD} = 1.2$  V
- **Auto Power-Down: 8 nA Typ, 300 nA Max**
- **0 V to  $V_{DD}$  Unipolar Input Range**
- **6-Pin SOT-23 Package**

### APPLICATIONS

- **Battery Powered Systems**
- **Isolated Data Acquisition**
- **Medical Instruments**
- **Portable Communication**
- **Portable Data Acquisition Systems**
- **Automatic Test Equipment**

### DESCRIPTION

The ADS7866/67/68 are low power, miniature, 12/10/8-bit A/D converters each with a unipolar, single-ended input. These devices can operate from a single 1.6 V to 3.6 V supply with a 200-KSPS throughput for ADS7866. In addition, these devices can maintain at least a 100-KSPS throughput with a supply as low as 1.2 V.

The sampling, conversion, and activation of digital output SDO are initiated on the falling edge of  $\overline{CS}$ . The serial clock SCLK is used for controlling the conversion rate and shifting data out of the converter. Furthermore, SCLK provides a mechanism to allow digital host processors to synchronize with the converter. These converters interface with micro-processors or DSPs through a high-speed SPI compatible serial interface. There are no pipeline delays associated with the device.

The minimum conversion time is determined by the frequency of the serial clock input, SCLK, while the maximum frequency of SCLK is determined by the minimum sampling time required to charge the input capacitance to 12/10/8-bit accuracy for the ADS7866/67/68, respectively. The maximum throughput is determined by how often a conversion is initiated when the minimum sampling time is met and the maximum SCLK frequency is used. Each device automatically powers down after each conversion, which allows each device to save power when the throughput is reduced while using the maximum SCLK frequency.

The converter reference is taken internally from the supply. Hence, the analog input range for these devices is 0 V to  $V_{DD}$ .

These devices are available in a 6-pin SOT-23 package and are characterized over the industrial  $-40^{\circ}\text{C}$  to  $85^{\circ}\text{C}$  temperature range.

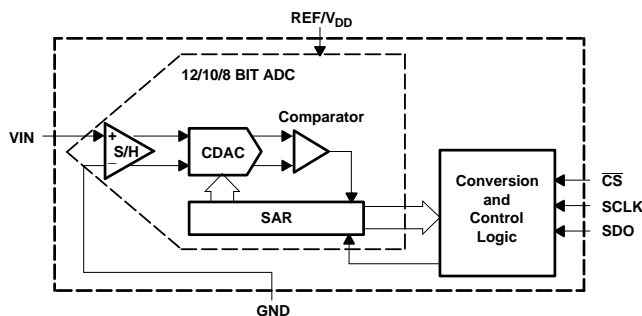

### Micro-Power Miniature SAR Converter Family

RESOLUTION/SPEED	< 200 KSPS	1 MSPS – 1.25 MSPS
12-Bit	ADS7866 (1.2 $V_{DD}$ to 3.6 $V_{DD}$ )	ADS7886 (2.35 $V_{DD}$ to 5.25 $V_{DD}$ )
10-Bit	ADS7867 (1.2 $V_{DD}$ to 3.6 $V_{DD}$ )	ADS7887 (2.35 $V_{DD}$ to 5.25 $V_{DD}$ )
8-Bit	ADS7868 (1.2 $V_{DD}$ to 3.6 $V_{DD}$ )	ADS7888 (2.35 $V_{DD}$ to 5.25 $V_{DD}$ )



Please be aware that an important notice concerning availability, standard warranty, and use in critical applications of Texas Instruments semiconductor products and disclaimers thereto appears at the end of this data sheet.



These devices have limited built-in ESD protection. The leads should be shorted together or the device placed in conductive foam during storage or handling to prevent electrostatic damage to the MOS gates.

### ORDERING INFORMATION<sup>(1)</sup>

MODEL	MAXIMUM INTEGRAL LINEARITY (LSB)	MAXIMUM DIFFERENTIAL LINEARITY (LSB)	NO MISSING CODES RESOLUTION (BIT)	PACKAGE TYPE	PACKAGE MARKING (SYMBOL)	PACKAGE DESIGNATOR	SPECIFIED TEMPERATURE RANGE	ORDERING NUMBER	TRANSPORT MEDIA, QUANTITY
ADS7866I	±1.5	-1/+1.5	12	SOT23-6	A66Y	DBV	-40°C to 85°C	ADS7866IDBVT	Small tape and reel, 250
ADS7866I	±1.5	-1/+1.5	12	SOT23-6	A66Y	DBV	-40°C to 85°C	ADS7866IDBVR	Tape and reel, 3000
ADS7867I	±0.5	±0.5	10	SOT23-6	A67Y	DBV	-40°C to 85°C	ADS7867IDBVT	Small tape and reel, 250
ADS7867I	±0.5	±0.5	10	SOT23-6	A67Y	DBV	-40°C to 85°C	ADS7867IDBVR	Tape and reel, 3000
ADS7868I	±0.5	±0.5	8	SOT23-6	A68Y	DBV	-40°C to 85°C	ADS7868IDBVT	Small tape and reel, 250
ADS7868I	±0.5	±0.5	8	SOT23-6	A68Y	DBV	-40°C to 85°C	ADS7868IDBVR	Tape and reel, 3000

(1) For the most current package and ordering information, see the Package Option Addendum at the end of this document, or see the TI web site at [www.ti.com](http://www.ti.com).

### ABSOLUTE MAXIMUM RATINGS

over operating free-air temperature range (unless otherwise noted)

		RATING
$V_{DD}$ to GND		-0.3 V to 4.0 V
Analog input voltage to GND		-0.3 V to $V_{DD} + 0.3$ V
Digital input voltage to GND		-0.3 V to 4.0 V
Digital output voltage to GND		-0.3 V to $V_{DD} + 0.3$ V
$T_A$	Operating free-air temperature range	-40°C to 85°C
$T_{STORAGE}$	Storage temperature range	-65°C to 150°C
$T_J$	Junction temperature	150°C
SOT-23 Package	$\theta_{JA}$ Thermal impedance	110.9°C/W
	$\theta_{JC}$ Thermal impedance	22.31°C/W
Lead temperature, soldering	Vapor phase (10–40 sec)	250°C
	Infrared (10–30 sec)	260°C
ESD		3 kV

**SPECIFICATIONS, ADS7866**

At  $-40^{\circ}\text{C}$  to  $85^{\circ}\text{C}$ ,  $f_{\text{SAMPLE}} = 200 \text{ KSPS}$  and  $f_{\text{SCLK}} = 3.4 \text{ MHz}$  if  $1.6 \text{ V} \leq V_{\text{DD}} \leq 3.6 \text{ V}$ ;  $f_{\text{SAMPLE}} = 100 \text{ KSPS}$  and  $f_{\text{SCLK}} = 1.7 \text{ MHz}$  if  $1.2 \text{ V} \leq V_{\text{DD}} < 1.6 \text{ V}$  (unless otherwise noted)

PARAMETER	TEST CONDITIONS	MIN	TYP	MAX	UNIT
<b>SYSTEM PERFORMANCE</b>					
Resolution			12		Bits
No missing codes		12			Bits
Integral linearity		-1.5		1.5	LSB <sup>(1)</sup>
Differential linearity		-1		1.5	LSB
Offset error <sup>(2)</sup>	$1.2 \text{ V} \leq V_{\text{DD}} < 1.6 \text{ V}$	-2		2	LSB
	$1.6 \text{ V} \leq V_{\text{DD}} \leq 3.6 \text{ V}$	-3		3	
Gain error <sup>(3)</sup>	$1.2 \text{ V} \leq V_{\text{DD}} < 1.6 \text{ V}$	-2		2	LSB
	$1.6 \text{ V} \leq V_{\text{DD}} \leq 3.6 \text{ V}$	-2		2	
Total unadjusted error <sup>(4)</sup>	$1.2 \text{ V} \leq V_{\text{DD}} < 1.6 \text{ V}$	-2.5		2.5	LSB
	$1.6 \text{ V} \leq V_{\text{DD}} \leq 3.6 \text{ V}$	-3.5		3.5	
<b>SAMPLING DYNAMICS (See Timing Characteristics Section)</b>					
$t_{\text{CONVERT}}$	Conversion time	$f_{\text{SCLK}} = 3.4 \text{ MHz}$ , 13 SCLK cycles		3.82	$\mu\text{s}$
$t_{\text{SAMPLE}}$	Acquisition time	$f_{\text{SCLK}} = 3.4 \text{ MHz}$ , $1.6 \text{ V} \leq V_{\text{DD}} \leq 3.6 \text{ V}$		0.64	$\mu\text{s}$
$f_{\text{SAMPLE}}$	Throughput rate	$f_{\text{SCLK}} = 3.4 \text{ MHz}$ , $1.6 \text{ V} \leq V_{\text{DD}} \leq 3.6 \text{ V}$		200	KSPS
	Aperture delay		10		ns
	Aperture jitter		40		ps
<b>DYNAMIC CHARACTERISTICS</b>					
SINAD	Signal-to-noise and distortion	$f_{\text{IN}} = 30 \text{ kHz}$ , $1.2 \text{ V} \leq V_{\text{DD}} < 1.6 \text{ V}$		68	dB
		$f_{\text{IN}} = 30 \text{ kHz}$ , $1.6 \text{ V} \leq V_{\text{DD}} \leq 3.6 \text{ V}$		69	
SNR	Signal-to-noise ratio	$f_{\text{IN}} = 30 \text{ kHz}$ , $1.2 \text{ V} \leq V_{\text{DD}} < 1.6 \text{ V}$		70	dB
		$f_{\text{IN}} = 30 \text{ kHz}$ , $1.6 \text{ V} \leq V_{\text{DD}} \leq 3.6 \text{ V}$		70	
THD	Total harmonic distortion <sup>(5)</sup>	$f_{\text{IN}} = 30 \text{ kHz}$ , $1.2 \text{ V} \leq V_{\text{DD}} < 1.6 \text{ V}$		-70	dB
		$f_{\text{IN}} = 30 \text{ kHz}$ , $1.6 \text{ V} \leq V_{\text{DD}} \leq 3.6 \text{ V}$		-83	
SFDR	Spurious free dynamic range	$f_{\text{IN}} = 30 \text{ kHz}$ , $1.2 \text{ V} \leq V_{\text{DD}} < 1.6 \text{ V}$		75	dB
		$f_{\text{IN}} = 30 \text{ kHz}$ , $1.6 \text{ V} \leq V_{\text{DD}} \leq 3.6 \text{ V}$		85	
	Full-power bandwidth <sup>(6)</sup>	At 0.1 dB, $1.2 \text{ V} \leq V_{\text{DD}} < 1.6 \text{ V}$		2	MHz
		At 0.1 dB, $1.6 \text{ V} \leq V_{\text{DD}} \leq 3.6 \text{ V}$		4	
		At 3 dB, $1.2 \text{ V} \leq V_{\text{DD}} < 1.6 \text{ V}$		3	
		At 3 dB, $1.6 \text{ V} \leq V_{\text{DD}} \leq 3.6 \text{ V}$		8	
<b>ANALOG INPUT</b>					
	Full-scale input span <sup>(7)</sup>	VIN – GND		0	$V_{\text{DD}}$
$C_{\text{S}}$	Input capacitance		12		pF
	Input leakage current	-1		1	$\mu\text{A}$
<b>DIGITAL INPUT</b>					
	Logic family, CMOS				
$V_{\text{IH}}$	Input logic high level	$1.2 \text{ V} \leq V_{\text{DD}} < 1.6 \text{ V}$		$0.7 \times V_{\text{DD}}$	3.6
		$1.6 \text{ V} \leq V_{\text{DD}} < 1.8 \text{ V}$		$0.7 \times V_{\text{DD}}$	3.6
		$1.8 \text{ V} \leq V_{\text{DD}} < 2.5 \text{ V}$		$0.7 \times V_{\text{DD}}$	3.6
		$2.5 \text{ V} \leq V_{\text{DD}} \leq 3.6 \text{ V}$		2	3.6

(1) LSB = Least Significant Bit

(2) The difference in the first code transition 000...000 to 000...001 from the ideal value of GND + 1 LSB.

(3) The difference in the last code transition 011...111 to 111...111 from the ideal value of  $V_{\text{DD}} - 1 \text{ LSB}$  with the offset error removed.

(4) The absolute difference from the ideal transfer function of the converter. This specification is similar to INL error except the effects of offset error and gain error are included.

(5) The 2nd through 10th harmonics are used to determine THD.

(6) Input frequency where the amplitude of the digitized signal has decreased by 0.1 dB or 3 dB.

(7) Ideal input span which does not include gain or offset errors.

**SPECIFICATIONS, ADS7866 (continued)**

At  $-40^{\circ}\text{C}$  to  $85^{\circ}\text{C}$ ,  $f_{\text{SAMPLE}} = 200$  KSPS and  $f_{\text{SCLK}} = 3.4$  MHz if  $1.6\text{ V} \leq V_{\text{DD}} \leq 3.6\text{ V}$ ;  $f_{\text{SAMPLE}} = 100$  KSPS and  $f_{\text{SCLK}} = 1.7$  MHz if  $1.2\text{ V} \leq V_{\text{DD}} < 1.6\text{ V}$  (unless otherwise noted)

PARAMETER	TEST CONDITIONS	MIN	TYP	MAX	UNIT	
$V_{\text{IL}}$ Input logic low level	$1.2\text{ V} \leq V_{\text{DD}} < 1.6\text{ V}$	-0.2		$0.2 \times V_{\text{DD}}$	V	
	$1.6\text{ V} \leq V_{\text{DD}} < 1.8\text{ V}$	-0.2		$0.2 \times V_{\text{DD}}$		
	$1.8\text{ V} \leq V_{\text{DD}} < 2.5\text{ V}$	-0.2		$0.3 \times V_{\text{DD}}$		
	$2.5\text{ V} \leq V_{\text{DD}} \leq 3.6\text{ V}$	-0.2		0.8		
$I_{\text{SCLK}}$ SCLK pin leakage current	Digital input = 0 V or $V_{\text{DD}}$	-1	0.02	1	$\mu\text{A}$	
$I_{\text{CS}}$ $\overline{\text{CS}}$ pin leakage current			$\pm 1$		$\mu\text{A}$	
$C_{\text{IN}}$ Digital input pin capacitance				10	pF	
<b>DIGITAL OUTPUT</b>						
$V_{\text{OH}}$ Output logic high level	$I_{\text{SOURCE}} = 200\ \mu\text{A}$	$V_{\text{DD}} - 0.2$		$V_{\text{DD}}$	V	
$V_{\text{OL}}$ Output logic low level	$I_{\text{SINK}} = 200\ \mu\text{A}$	0		0.2	V	
$I_{\text{SDO}}$ SDO pin leakage current	Floating output	-1		1	$\mu\text{A}$	
$C_{\text{OUT}}$ Digital output pin capacitance	Floating output			10	pF	
Data format, straight binary						
<b>POWER SUPPLY REQUIREMENTS</b>						
$V_{\text{DD}}$ Supply voltage		1.2		3.6	V	
$I_{\text{DD}}$ Supply current, normal operation	Digital inputs = 0 V or $V_{\text{DD}}$	$f_{\text{SAMPLE}} = 200$ KSPS, $f_{\text{SCLK}} = 3.4$ MHz, $V_{\text{DD}} = 3.6\text{ V}$		385	500	$\mu\text{A}$
		$f_{\text{SAMPLE}} = 100$ KSPS, $f_{\text{SCLK}} = 3.4$ MHz, $V_{\text{DD}} = 3.6\text{ V}$		193		
		$f_{\text{SAMPLE}} = 50$ KSPS, $f_{\text{SCLK}} = 3.4$ MHz, $V_{\text{DD}} = 3.6\text{ V}$		97		
		$f_{\text{SAMPLE}} = 20$ KSPS, $f_{\text{SCLK}} = 3.4$ MHz, $V_{\text{DD}} = 3.6\text{ V}$		39		
		$f_{\text{SAMPLE}} = 200$ KSPS, $f_{\text{SCLK}} = 3.4$ MHz, $V_{\text{DD}} = 3\text{ V}$		340		$\mu\text{A}$
		$f_{\text{SAMPLE}} = 100$ KSPS, $f_{\text{SCLK}} = 3.4$ MHz, $V_{\text{DD}} = 3\text{ V}$		170		
		$f_{\text{SAMPLE}} = 50$ KSPS, $f_{\text{SCLK}} = 3.4$ MHz, $V_{\text{DD}} = 3\text{ V}$		85		
		$f_{\text{SAMPLE}} = 20$ KSPS, $f_{\text{SCLK}} = 3.4$ MHz, $V_{\text{DD}} = 3\text{ V}$		35		
		$f_{\text{SAMPLE}} = 200$ KSPS, $f_{\text{SCLK}} = 3.4$ MHz, $V_{\text{DD}} = 2.5\text{ V}$		305		$\mu\text{A}$
		$f_{\text{SAMPLE}} = 100$ KSPS, $f_{\text{SCLK}} = 3.4$ MHz, $V_{\text{DD}} = 2.5\text{ V}$		153		
		$f_{\text{SAMPLE}} = 50$ KSPS, $f_{\text{SCLK}} = 3.4$ MHz, $V_{\text{DD}} = 2.5\text{ V}$		77		
		$f_{\text{SAMPLE}} = 20$ KSPS, $f_{\text{SCLK}} = 3.4$ MHz, $V_{\text{DD}} = 2.5\text{ V}$		31		
		$f_{\text{SAMPLE}} = 200$ KSPS, $f_{\text{SCLK}} = 3.4$ MHz, $V_{\text{DD}} = 1.8\text{ V}$		256		$\mu\text{A}$
		$f_{\text{SAMPLE}} = 100$ KSPS, $f_{\text{SCLK}} = 3.4$ MHz, $V_{\text{DD}} = 1.8\text{ V}$		128		
		$f_{\text{SAMPLE}} = 50$ KSPS, $f_{\text{SCLK}} = 3.4$ MHz, $V_{\text{DD}} = 1.8\text{ V}$		65		
		$f_{\text{SAMPLE}} = 20$ KSPS, $f_{\text{SCLK}} = 3.4$ MHz, $V_{\text{DD}} = 1.8\text{ V}$		26		
		$f_{\text{SAMPLE}} = 200$ KSPS, $f_{\text{SCLK}} = 3.4$ MHz, $V_{\text{DD}} = 1.6\text{ V}$		241	330	$\mu\text{A}$
		$f_{\text{SAMPLE}} = 100$ KSPS, $f_{\text{SCLK}} = 3.4$ MHz, $V_{\text{DD}} = 1.6\text{ V}$		121		
		$f_{\text{SAMPLE}} = 50$ KSPS, $f_{\text{SCLK}} = 3.4$ MHz, $V_{\text{DD}} = 1.6\text{ V}$		61		
		$f_{\text{SAMPLE}} = 20$ KSPS, $f_{\text{SCLK}} = 3.4$ MHz, $V_{\text{DD}} = 1.6\text{ V}$		25		
$f_{\text{SAMPLE}} = 100$ KSPS, $f_{\text{SCLK}} = 1.7$ MHz, $V_{\text{DD}} = 1.2\text{ V}$		186	250	$\mu\text{A}$		
$f_{\text{SAMPLE}} = 50$ KSPS, $f_{\text{SCLK}} = 1.7$ MHz, $V_{\text{DD}} = 1.2\text{ V}$		93				
$f_{\text{SAMPLE}} = 20$ KSPS, $f_{\text{SCLK}} = 1.7$ MHz, $V_{\text{DD}} = 1.2\text{ V}$		37				
$I_{\text{DD}}$ Power-down mode	SCLK on or off		0.008	0.3	$\mu\text{A}$	
<b>POWER DISSIPATION</b>						
Normal operation	$f_{\text{SAMPLE}} = 200$ KSPS, $f_{\text{SCLK}} = 3.4$ MHz, $V_{\text{DD}} = 3.6\text{ V}$		1.39	1.80	mW	
	$f_{\text{SAMPLE}} = 200$ KSPS, $f_{\text{SCLK}} = 3.4$ MHz, $V_{\text{DD}} = 1.6\text{ V}$		0.39	0.53		
	$f_{\text{SAMPLE}} = 100$ KSPS, $f_{\text{SCLK}} = 1.7$ MHz, $V_{\text{DD}} = 1.2\text{ V}$		0.22	0.3		
Power-down mode	SCLK on or off, $V_{\text{DD}} = 3.6\text{ V}$		1.08		$\mu\text{W}$	
<b>TEMPERATURE RANGE</b>						
Specified performance		-40		85	$^{\circ}\text{C}$	

**SPECIFICATIONS, ADS7867**

At  $-40^{\circ}\text{C}$  to  $85^{\circ}\text{C}$ ,  $f_{\text{SAMPLE}} = 240$  KSPS and  $f_{\text{SCLK}} = 3.4$  MHz if  $1.6\text{ V} \leq V_{\text{DD}} \leq 3.6\text{ V}$ ;  $f_{\text{SAMPLE}} = 120$  KSPS and  $f_{\text{SCLK}} = 1.7$  MHz if  $1.2\text{ V} \leq V_{\text{DD}} < 1.6\text{ V}$  (unless otherwise noted)

PARAMETER		TEST CONDITIONS	MIN	TYP	MAX	UNIT
<b>SYSTEM PERFORMANCE</b>						
Resolution				10		Bits
No missing codes			10			Bits
Integral linearity			-0.5		0.5	LSB <sup>(1)</sup>
Differential linearity			-0.5		0.5	LSB
Offset error <sup>(2)</sup>	$1.2\text{ V} \leq V_{\text{DD}} < 1.6\text{ V}$		-0.75		0.75	LSB
	$1.6\text{ V} \leq V_{\text{DD}} \leq 3.6\text{ V}$		-1		1	
Gain error <sup>(3)</sup>	$1.2\text{ V} \leq V_{\text{DD}} < 1.6\text{ V}$		-0.5		0.5	LSB
	$1.6\text{ V} \leq V_{\text{DD}} \leq 3.6\text{ V}$		-0.5		0.5	
Total unadjusted error <sup>(4)</sup>	$1.2\text{ V} \leq V_{\text{DD}} < 1.6\text{ V}$		-2		2	LSB
	$1.6\text{ V} \leq V_{\text{DD}} \leq 3.6\text{ V}$		-2		2	
<b>SAMPLING DYNAMICS (See Timing Characteristics Section)</b>						
$t_{\text{CONVERT}}$	Conversion time	$f_{\text{SCLK}} = 3.4$ MHz, 11 SCLK cycles	3.235			$\mu\text{s}$
$t_{\text{SAMPLE}}$	Acquisition time	$f_{\text{SCLK}} = 3.4$ MHz, $1.6\text{ V} \leq V_{\text{DD}} \leq 3.6\text{ V}$	0.64			$\mu\text{s}$
$f_{\text{SAMPLE}}$	Throughput rate	$f_{\text{SCLK}} = 3.4$ MHz, $1.6\text{ V} \leq V_{\text{DD}} \leq 3.6\text{ V}$			240	KSPS
Aperture delay				10		ns
Aperture jitter				40		ps
<b>DYNAMIC CHARACTERISTICS</b>						
SINAD	Signal-to-noise and distortion	$f_{\text{SAMPLE}} = 100$ KSPS, $f_{\text{IN}} = 30$ kHz, $1.2\text{ V} \leq V_{\text{DD}} < 1.6\text{ V}$		61		dB
		$f_{\text{SAMPLE}} = 200$ KSPS, $f_{\text{IN}} = 30$ kHz, $1.6\text{ V} \leq V_{\text{DD}} \leq 3.6\text{ V}$	61	61.7		
SNR	Signal-to-noise ratio	$f_{\text{SAMPLE}} = 100$ KSPS, $f_{\text{IN}} = 30$ kHz, $1.2\text{ V} \leq V_{\text{DD}} < 1.6\text{ V}$		61.5		dB
		$f_{\text{SAMPLE}} = 200$ KSPS, $f_{\text{IN}} = 30$ kHz, $1.6\text{ V} \leq V_{\text{DD}} \leq 3.6\text{ V}$		61.8		
THD	Total harmonic distortion <sup>(5)</sup>	$f_{\text{SAMPLE}} = 100$ KSPS, $f_{\text{IN}} = 30$ kHz, $1.2\text{ V} \leq V_{\text{DD}} < 1.6\text{ V}$		-68		dB
		$f_{\text{SAMPLE}} = 200$ KSPS, $f_{\text{IN}} = 30$ kHz, $1.6\text{ V} \leq V_{\text{DD}} \leq 3.6\text{ V}$		-78	-72	
SFDR	Spurious free dynamic range	$f_{\text{SAMPLE}} = 100$ KSPS, $f_{\text{IN}} = 30$ kHz, $1.2\text{ V} \leq V_{\text{DD}} < 1.6\text{ V}$		73		dB
		$f_{\text{SAMPLE}} = 200$ KSPS, $f_{\text{IN}} = 30$ kHz, $1.6\text{ V} \leq V_{\text{DD}} \leq 3.6\text{ V}$	74	80		
Full-power bandwidth <sup>(6)</sup>		At 0.1 dB, $1.2\text{ V} \leq V_{\text{DD}} < 1.6\text{ V}$		2		MHz
		At 0.1 dB, $1.6\text{ V} \leq V_{\text{DD}} \leq 3.6\text{ V}$		4		
		At 3 dB, $1.2\text{ V} \leq V_{\text{DD}} < 1.6\text{ V}$		3		
		At 3 dB, $1.6\text{ V} \leq V_{\text{DD}} \leq 3.6\text{ V}$		8		
<b>ANALOG INPUT</b>						
Full-scale input span <sup>(7)</sup>		$V_{\text{IN}} - \text{GND}$	0		$V_{\text{DD}}$	V
$C_{\text{S}}$	Input capacitance			12		pF
Input leakage current			-1		1	$\mu\text{A}$
<b>DIGITAL INPUT</b>						
Logic family, CMOS						
$V_{\text{IH}}$	Input logic high level	$1.2\text{ V} \leq V_{\text{DD}} < 1.6\text{ V}$		$0.7 \times V_{\text{DD}}$		3.6
		$1.6\text{ V} \leq V_{\text{DD}} < 1.8\text{ V}$		$0.7 \times V_{\text{DD}}$		3.6
		$1.8\text{ V} \leq V_{\text{DD}} < 2.5\text{ V}$		$0.7 \times V_{\text{DD}}$		3.6
		$2.5\text{ V} \leq V_{\text{DD}} \leq 3.6\text{ V}$		2		3.6

(1) LSB = Least Significant Bit

(2) The difference in the first code transition 000...000 to 000...001 from the ideal value of  $\text{GND} + 1$  LSB.

(3) The difference in the last code transition 011...111 to 111...111 from the ideal value of  $V_{\text{DD}} - 1$  LSB with the offset error removed.

(4) The absolute difference from the ideal transfer function of the converter. This specification is similar to INL error except the effects of offset error and gain error are included.

(5) The 2nd through 10th harmonics are used to determine THD.

(6) Input frequency where the amplitude of the digitized signal has decreased by 0.1 dB or 3 dB.

(7) Ideal input span which does not include gain or offset errors.

## SPECIFICATIONS, ADS7867 (continued)

At  $-40^{\circ}\text{C}$  to  $85^{\circ}\text{C}$ ,  $f_{\text{SAMPLE}} = 240$  KSPS and  $f_{\text{SCLK}} = 3.4$  MHz if  $1.6\text{ V} \leq V_{\text{DD}} \leq 3.6\text{ V}$ ;  $f_{\text{SAMPLE}} = 120$  KSPS and  $f_{\text{SCLK}} = 1.7$  MHz if  $1.2\text{ V} \leq V_{\text{DD}} < 1.6\text{ V}$  (unless otherwise noted)

PARAMETER	TEST CONDITIONS	MIN	TYP	MAX	UNIT
$V_{\text{IL}}$ Input logic low level	$1.2\text{ V} \leq V_{\text{DD}} < 1.6\text{ V}$	-0.2		$0.2 \times V_{\text{DD}}$	V
	$1.6\text{ V} \leq V_{\text{DD}} < 1.8\text{ V}$	-0.2		$0.2 \times V_{\text{DD}}$	
	$1.8\text{ V} \leq V_{\text{DD}} < 2.5\text{ V}$	-0.2		$0.3 \times V_{\text{DD}}$	
	$2.5\text{ V} \leq V_{\text{DD}} \leq 3.6\text{ V}$	-0.2		0.8	
$I_{\text{SCLK}}$ SCLK pin leakage current	Digital input = 0 V or $V_{\text{DD}}$	-1	0.02	1	$\mu\text{A}$
$I_{\text{CS}}$ $\overline{\text{CS}}$ pin leakage current			$\pm 1$		$\mu\text{A}$
$C_{\text{IN}}$ Digital input pin capacitance				10	pF
<b>DIGITAL OUTPUT</b>					
$V_{\text{OH}}$ Output logic high level	$I_{\text{SOURCE}} = 200\ \mu\text{A}$	$V_{\text{DD}} - 0.2$		$V_{\text{DD}}$	V
$V_{\text{OL}}$ Output logic low level	$I_{\text{SINK}} = 200\ \mu\text{A}$	0		0.2	V
$I_{\text{SDO}}$ SDO pin leakage current	Floating output	-1		1	$\mu\text{A}$
$C_{\text{OUT}}$ Digital output pin capacitance	Floating output			10	pF
	Data format, straight binary				
<b>POWER SUPPLY REQUIREMENTS</b>					
$V_{\text{DD}}$ Supply voltage		1.2		3.6	V
$I_{\text{DD}}$ Supply current, normal operation	Digital Inputs = 0 V or $V_{\text{DD}}$	$f_{\text{SAMPLE}} = 240$ KSPS, $f_{\text{SCLK}} = 3.4$ MHz, $V_{\text{DD}} = 3.6\text{ V}$	420	500	$\mu\text{A}$
		$f_{\text{SAMPLE}} = 100$ KSPS, $f_{\text{SCLK}} = 3.4$ MHz, $V_{\text{DD}} = 3.6\text{ V}$	172		
		$f_{\text{SAMPLE}} = 240$ KSPS, $f_{\text{SCLK}} = 3.4$ MHz, $V_{\text{DD}} = 1.6\text{ V}$	261	330	$\mu\text{A}$
		$f_{\text{SAMPLE}} = 100$ KSPS, $f_{\text{SCLK}} = 3.4$ MHz, $V_{\text{DD}} = 1.6\text{ V}$	107		
		$f_{\text{SAMPLE}} = 120$ KSPS, $f_{\text{SCLK}} = 1.7$ MHz, $V_{\text{DD}} = 1.2\text{ V}$	202	250	$\mu\text{A}$
		$f_{\text{SAMPLE}} = 50$ KSPS, $f_{\text{SCLK}} = 1.7$ MHz, $V_{\text{DD}} = 1.2\text{ V}$	83		
$I_{\text{DD}}$ Power-down mode	SCLK on or off		0.008	0.3	$\mu\text{A}$
<b>POWER DISSIPATION</b>					
Normal operation	$f_{\text{SAMPLE}} = 240$ KSPS, $f_{\text{SCLK}} = 3.4$ MHz, $V_{\text{DD}} = 3.6\text{ V}$		1.51	1.80	mW
	$f_{\text{SAMPLE}} = 240$ KSPS, $f_{\text{SCLK}} = 3.4$ MHz, $V_{\text{DD}} = 1.6\text{ V}$		0.42	0.53	
	$f_{\text{SAMPLE}} = 120$ KSPS, $f_{\text{SCLK}} = 1.7$ MHz, $V_{\text{DD}} = 1.2\text{ V}$		0.24	0.30	
Power-down mode	SCLK on or off, $V_{\text{DD}} = 3.6\text{ V}$			1.08	$\mu\text{W}$
<b>TEMPERATURE RANGE</b>					
Specified performance		-40		85	$^{\circ}\text{C}$

**SPECIFICATIONS, ADS7868**

At  $-40^{\circ}\text{C}$  to  $85^{\circ}\text{C}$ ,  $f_{\text{SAMPLE}} = 280 \text{ KSPS}$  and  $f_{\text{SCLK}} = 3.4 \text{ MHz}$  if  $1.6 \text{ V} \leq V_{\text{DD}} \leq 3.6 \text{ V}$ ;  $f_{\text{SAMPLE}} = 140 \text{ KSPS}$  and  $f_{\text{SCLK}} = 1.7 \text{ MHz}$  if  $1.2 \text{ V} \leq V_{\text{DD}} < 1.6 \text{ V}$  (unless otherwise noted)

PARAMETER		TEST CONDITIONS	MIN	TYP	MAX	UNIT
<b>SYSTEM PERFORMANCE</b>						
Resolution				8		Bits
No missing codes			8			Bits
Integral linearity			-0.5		0.5	LSB <sup>(1)</sup>
Differential linearity			-0.5		0.5	LSB
Offset error <sup>(2)</sup>		$1.2 \text{ V} \leq V_{\text{DD}} < 1.6 \text{ V}$	-0.5		0.5	LSB
		$1.6 \text{ V} \leq V_{\text{DD}} \leq 3.6 \text{ V}$	-0.5		0.5	
Gain error <sup>(3)</sup>		$1.2 \text{ V} \leq V_{\text{DD}} < 1.6 \text{ V}$	-0.5		0.5	LSB
		$1.6 \text{ V} \leq V_{\text{DD}} \leq 3.6 \text{ V}$	-0.5		0.5	
Total unadjusted error <sup>(4)</sup>		$1.2 \text{ V} \leq V_{\text{DD}} < 1.6 \text{ V}$	-1		1	LSB
		$1.6 \text{ V} \leq V_{\text{DD}} \leq 3.6 \text{ V}$	-1		1	
<b>SAMPLING DYNAMICS (See Timing Characteristics Section)</b>						
$t_{\text{CONVERT}}$	Conversion time	$f_{\text{SCLK}} = 3.4 \text{ MHz}$ , 9 SCLK cycles	2.647			$\mu\text{s}$
$t_{\text{SAMPLE}}$	Acquisition time	$f_{\text{SCLK}} = 3.4 \text{ MHz}$ , $1.6 \text{ V} \leq V_{\text{DD}} \leq 3.6 \text{ V}$	0.64			$\mu\text{s}$
$f_{\text{SAMPLE}}$	Throughput rate	$f_{\text{SCLK}} = 3.4 \text{ MHz}$ , $1.6 \text{ V} \leq V_{\text{DD}} \leq 3.6 \text{ V}$			280	KSPS
Aperture delay				10		ns
Aperture jitter				40		ps
<b>DYNAMIC CHARACTERISTICS</b>						
SINAD	Signal-to-noise and distortion	$f_{\text{SAMPLE}} = 100 \text{ KSPS}$ , $f_{\text{IN}} = 30 \text{ kHz}$ , $1.2 \text{ V} \leq V_{\text{DD}} < 1.6 \text{ V}$		49		dB
		$f_{\text{SAMPLE}} = 200 \text{ KSPS}$ , $f_{\text{IN}} = 30 \text{ kHz}$ , $1.6 \text{ V} \leq V_{\text{DD}} \leq 3.6 \text{ V}$	49	49.4		
SNR	Signal-to-noise ratio	$f_{\text{SAMPLE}} = 100 \text{ KSPS}$ , $f_{\text{IN}} = 30 \text{ kHz}$ , $1.2 \text{ V} \leq V_{\text{DD}} < 1.6 \text{ V}$		49.4		dB
		$f_{\text{SAMPLE}} = 200 \text{ KSPS}$ , $f_{\text{IN}} = 30 \text{ kHz}$ , $1.6 \text{ V} \leq V_{\text{DD}} \leq 3.6 \text{ V}$		49.8		
THD	Total harmonic distortion <sup>(5)</sup>	$f_{\text{SAMPLE}} = 100 \text{ KSPS}$ , $f_{\text{IN}} = 30 \text{ kHz}$ , $1.2 \text{ V} \leq V_{\text{DD}} < 1.6 \text{ V}$		-65		dB
		$f_{\text{SAMPLE}} = 200 \text{ KSPS}$ , $f_{\text{IN}} = 30 \text{ kHz}$ , $1.6 \text{ V} \leq V_{\text{DD}} \leq 3.6 \text{ V}$		-72	-66	
SFDR	Spurious free dynamic range	$f_{\text{SAMPLE}} = 100 \text{ KSPS}$ , $f_{\text{IN}} = 30 \text{ kHz}$ , $1.2 \text{ V} \leq V_{\text{DD}} < 1.6 \text{ V}$		67		dB
		$f_{\text{SAMPLE}} = 200 \text{ KSPS}$ , $f_{\text{IN}} = 30 \text{ kHz}$ , $1.6 \text{ V} \leq V_{\text{DD}} \leq 3.6 \text{ V}$	66	67		
	Full-power bandwidth <sup>(6)</sup>	At 0.1 dB, $1.2 \text{ V} \leq V_{\text{DD}} < 1.6 \text{ V}$		2		MHz
		At 0.1 dB, $1.6 \text{ V} \leq V_{\text{DD}} \leq 3.6 \text{ V}$		4		
		At 3 dB, $1.2 \text{ V} \leq V_{\text{DD}} < 1.6 \text{ V}$		3		
		At 3 dB, $1.6 \text{ V} \leq V_{\text{DD}} \leq 3.6 \text{ V}$		8		
<b>ANALOG INPUT</b>						
	Full-scale input span <sup>(7)</sup>	$V_{\text{IN}} - \text{GND}$	0		$V_{\text{DD}}$	V
$C_{\text{S}}$	Input capacitance			12		pF
	Input leakage current		-1		1	$\mu\text{A}$
<b>DIGITAL INPUT</b>						
	Logic family, CMOS					
$V_{\text{IH}}$	Input logic high level	$1.2 \text{ V} \leq V_{\text{DD}} < 1.6 \text{ V}$		$0.7 \times V_{\text{DD}}$	3.6	V
		$1.6 \text{ V} \leq V_{\text{DD}} < 1.8 \text{ V}$		$0.7 \times V_{\text{DD}}$	3.6	
		$1.8 \text{ V} \leq V_{\text{DD}} < 2.5 \text{ V}$		$0.7 \times V_{\text{DD}}$	3.6	
		$2.5 \text{ V} \leq V_{\text{DD}} \leq 3.6 \text{ V}$	2		3.6	

(1) LSB = Least Significant Bit

(2) The difference in the first code transition 000...000 to 000...001 from the ideal value of  $\text{GND} + 1 \text{ LSB}$ .

(3) The difference in the last code transition 011...111 to 111...111 from the ideal value of  $V_{\text{DD}} - 1 \text{ LSB}$  with the offset error removed.

(4) The absolute difference from the ideal transfer function of the converter. This specification is similar to INL error except the effects of offset error and gain error are included.

(5) The 2nd through 10th harmonics are used to determine THD.

(6) Input frequency where the amplitude of the digitized signal has decreased by 0.1 dB or 3 dB.

(7) Ideal input span which does not include gain or offset errors.

**SPECIFICATIONS, ADS7868 (continued)**

At  $-40^{\circ}\text{C}$  to  $85^{\circ}\text{C}$ ,  $f_{\text{SAMPLE}} = 280$  KSPS and  $f_{\text{SCLK}} = 3.4$  MHz if  $1.6\text{ V} \leq V_{\text{DD}} \leq 3.6\text{ V}$ ;  $f_{\text{SAMPLE}} = 140$  KSPS and  $f_{\text{SCLK}} = 1.7$  MHz if  $1.2\text{ V} \leq V_{\text{DD}} < 1.6\text{ V}$  (unless otherwise noted)

PARAMETER	TEST CONDITIONS		MIN	TYP	MAX	UNIT
$V_{\text{IL}}$ Input logic low level	$1.2\text{ V} \leq V_{\text{DD}} < 1.6\text{ V}$		-0.2		$0.2 \times V_{\text{DD}}$	V
	$1.6\text{ V} \leq V_{\text{DD}} < 1.8\text{ V}$		-0.2		$0.2 \times V_{\text{DD}}$	
	$1.8\text{ V} \leq V_{\text{DD}} < 2.5\text{ V}$		-0.2		$0.3 \times V_{\text{DD}}$	
	$2.5\text{ V} \leq V_{\text{DD}} \leq 3.6\text{ V}$		-0.2		0.8	
$I_{\text{SCLK}}$ SCLK pin leakage current	Digital input = 0 V or $V_{\text{DD}}$		-1	0.02	1	$\mu\text{A}$
$I_{\text{CS}}$ $\overline{\text{CS}}$ pin leakage current				$\pm 1$		$\mu\text{A}$
$C_{\text{IN}}$ Digital input pin capacitance					10	pF
<b>DIGITAL OUTPUT</b>						
$V_{\text{OH}}$ Output logic high level	$I_{\text{SOURCE}} = 200\ \mu\text{A}$		$V_{\text{DD}} - 0.2$		$V_{\text{DD}}$	V
$V_{\text{OL}}$ Output logic low level	$I_{\text{SINK}} = 200\ \mu\text{A}$		0		0.2	V
$I_{\text{SDO}}$ SDO pin leakage current	Floating output		-1		1	$\mu\text{A}$
$C_{\text{OUT}}$ Digital output pin capacitance	Floating output				10	pF
Data format, straight binary						
<b>POWER SUPPLY REQUIREMENTS</b>						
$V_{\text{DD}}$ Supply voltage			1.2		3.6	V
$I_{\text{DD}}$ Supply current, normal operation	Digital Inputs = 0 V or $V_{\text{DD}}$	$f_{\text{SAMPLE}} = 280$ KSPS, $f_{\text{SCLK}} = 3.4$ MHz, $V_{\text{DD}} = 3.6\text{ V}$		439	500	$\mu\text{A}$
		$f_{\text{SAMPLE}} = 100$ KSPS, $f_{\text{SCLK}} = 3.4$ MHz, $V_{\text{DD}} = 3.6\text{ V}$		154		
		$f_{\text{SAMPLE}} = 280$ KSPS, $f_{\text{SCLK}} = 3.4$ MHz, $V_{\text{DD}} = 1.6\text{ V}$		264	330	$\mu\text{A}$
		$f_{\text{SAMPLE}} = 100$ KSPS, $f_{\text{SCLK}} = 3.4$ MHz, $V_{\text{DD}} = 1.6\text{ V}$		93		
		$f_{\text{SAMPLE}} = 140$ KSPS, $f_{\text{SCLK}} = 1.7$ MHz, $V_{\text{DD}} = 1.2\text{ V}$		201	250	$\mu\text{A}$
		$f_{\text{SAMPLE}} = 50$ KSPS, $f_{\text{SCLK}} = 1.7$ MHz, $V_{\text{DD}} = 1.2\text{ V}$		70		
$I_{\text{DD}}$ Power-down mode	SCLK on or off			0.008	0.3	$\mu\text{A}$
<b>POWER DISSIPATION</b>						
Normal operation	$f_{\text{SAMPLE}} = 280$ KSPS, $f_{\text{SCLK}} = 3.4$ MHz, $V_{\text{DD}} = 3.6\text{ V}$			1.58	1.8	mW
	$f_{\text{SAMPLE}} = 280$ KSPS, $f_{\text{SCLK}} = 3.4$ MHz, $V_{\text{DD}} = 1.6\text{ V}$			0.42	0.53	
	$f_{\text{SAMPLE}} = 140$ KSPS, $f_{\text{SCLK}} = 1.7$ MHz, $V_{\text{DD}} = 1.2\text{ V}$			0.24	0.3	
Power-down mode	SCLK on or off, $V_{\text{DD}} = 3.6\text{ V}$				1.08	$\mu\text{W}$
<b>TEMPERATURE RANGE</b>						
Specified performance			-40		85	$^{\circ}\text{C}$

## TIMING REQUIREMENTS<sup>(1)(2)</sup>

At  $-40^{\circ}\text{C}$  to  $85^{\circ}\text{C}$ ,  $f_{\text{SCLK}} = 3.4 \text{ MHz}$  if  $1.6 \text{ V} \leq V_{\text{DD}} \leq 3.6 \text{ V}$ ;  $f_{\text{SCLK}} = 1.7 \text{ MHz}$  if  $1.2 \text{ V} \leq V_{\text{DD}} < 1.6 \text{ V}$ , 50-pF Load on SDO Pin, unless otherwise noted

PARAMETER	TEST CONDITIONS	MIN	TYP	MAX	UNIT
$t_{\text{sample}}$	Sample time	$t_{\text{SU(CSF-FSCLKF)}} + 2 \times t_{\text{C(SCLK)}}$			$\mu\text{s}$
$t_{\text{convert}}$	Conversion time	ADS7866	$13 \times t_{\text{C(SCLK)}}$		$\mu\text{s}$
		ADS7867	$11 \times t_{\text{C(SCLK)}}$		
		ADS7868	$9 \times t_{\text{C(SCLK)}}$		
$t_{\text{C(SCLK)}}$	Cycle time	$1.2 \text{ V} \leq V_{\text{DD}} < 1.6 \text{ V}$	See (3)		$\mu\text{s}$
		$1.6 \text{ V} \leq V_{\text{DD}} < 1.8 \text{ V}$	See (3)		
		$1.8 \text{ V} \leq V_{\text{DD}} < 2.5 \text{ V}$	See (3)		
		$2.5 \text{ V} \leq V_{\text{DD}} \leq 3.6 \text{ V}$	See (3)		
$t_{\text{WH(SCLK)}}$	Pulse duration	$0.4 \times t_{\text{C(SCLK)}}$		$0.6 \times t_{\text{C(SCLK)}}$	ns
$t_{\text{WL(SCLK)}}$	Pulse duration	$0.4 \times t_{\text{C(SCLK)}}$		$0.6 \times t_{\text{C(SCLK)}}$	ns
$t_{\text{SU(CSF-FSCLKF)}}$	Setup time	$1.2 \text{ V} \leq V_{\text{DD}} < 1.6 \text{ V}$	192		ns
		$1.6 \text{ V} \leq V_{\text{DD}} < 1.8 \text{ V}$	55		
		$1.8 \text{ V} \leq V_{\text{DD}} \leq 3.6 \text{ V}$	55		
$t_{\text{D(CSF-SDOVALID)}}$	Delay time	$1.2 \text{ V} \leq V_{\text{DD}} < 1.6 \text{ V}$			ns
		$1.6 \text{ V} \leq V_{\text{DD}} < 1.8 \text{ V}$	65		
		$1.8 \text{ V} \leq V_{\text{DD}} \leq 3.6 \text{ V}$	55		
$t_{\text{H(SCLKF-SDOVALID)}}$	Hold time	$1.2 \text{ V} \leq V_{\text{DD}} < 1.6 \text{ V}$	20		ns
		$1.6 \text{ V} \leq V_{\text{DD}} < 1.8 \text{ V}$	10		
		$1.8 \text{ V} \leq V_{\text{DD}} \leq 3.6 \text{ V}$	10		
$t_{\text{D(SCLKF-SDOVALID)}}$	Delay time	$1.2 \text{ V} \leq V_{\text{DD}} < 1.6 \text{ V}$			ns
		$1.6 \text{ V} \leq V_{\text{DD}} < 1.8 \text{ V}$	140		
		$1.8 \text{ V} \leq V_{\text{DD}} \leq 3.6 \text{ V}$	140		
$t_{\text{DIS(EOC-SDOZ)}}$	Disable time	$1.2 \text{ V} \leq V_{\text{DD}} < 1.6 \text{ V}$	10		ns
		$1.6 \text{ V} \leq V_{\text{DD}} < 1.8 \text{ V}$	7		
		$1.8 \text{ V} \leq V_{\text{DD}} \leq 3.6 \text{ V}$	7		
$t_{\text{WH(CS)}}$	Pulse duration	$1.2 \text{ V} \leq V_{\text{DD}} < 1.6 \text{ V}$	20		ns
		$1.6 \text{ V} \leq V_{\text{DD}} < 1.8 \text{ V}$	10		
		$1.8 \text{ V} \leq V_{\text{DD}} \leq 3.6 \text{ V}$	10		
$t_{\text{SU(LSBZ-CSF)}}$	Setup time	$1.2 \text{ V} \leq V_{\text{DD}} < 1.6 \text{ V}$	20		ns
		$1.6 \text{ V} \leq V_{\text{DD}} < 1.8 \text{ V}$	10		
		$1.8 \text{ V} \leq V_{\text{DD}} \leq 3.6 \text{ V}$	10		

(1) All input signals are specified with  $t_r = t_f = 5 \text{ ns}$  (10% to 90% of  $V_{\text{DD}}$ ) and timed from a voltage level of  $(V_{\text{L}} + V_{\text{H}})/2$ .

(2) See timing diagram in Figure 1.

(3) Min  $t_{\text{C(SCLK)}}$  is determined by the Min  $t_{\text{SAMPLE}}$  of the specific resolution and supply voltage. See *Acquisition Time, Conversion Time, and Total Cycle Time* section for further details.

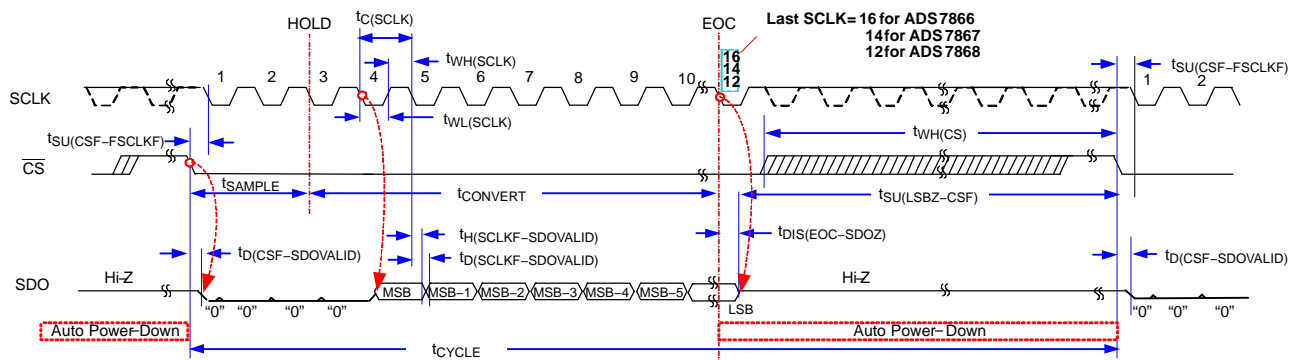
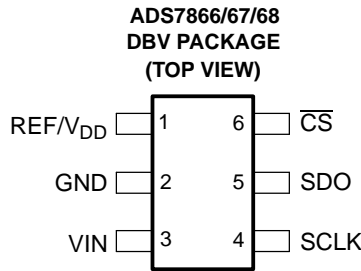

Figure 1. Timing Diagram

**PIN CONFIGURATION**



**TERMINAL FUNCTIONS**

TERMINAL		DESCRIPTION
NAME	NO.	
REF/V <sub>DD</sub>	1	External reference input and power supply
GND	2	Ground for signal and power supply. All analog and digital signals are referred with respect to this pin.
VIN	3	Analog signal input
SCLK	4	Serial clock input. This clock is used for clocking data out, and it is the source of conversion clock.
SDO	5	This is the serial data output of the conversion result. The serial stream comes with MSB first. The MSB is clocked out (changed) on the falling edge one SCLK after the sampling period ends. This results in four leading zeros after $\overline{\text{CS}}$ becomes active. SDO is 3-stated once all the valid bits are clocked out (12 for ADS7866, 10 for ADS7867, and 8 for ADS7868).
$\overline{\text{CS}}$	6	This is an active low input signal. It is used as a chip select to gate the SCLK input, to initiate a conversion, and to frame output data.

**TYPICAL CHARACTERISTICS ADS7866**

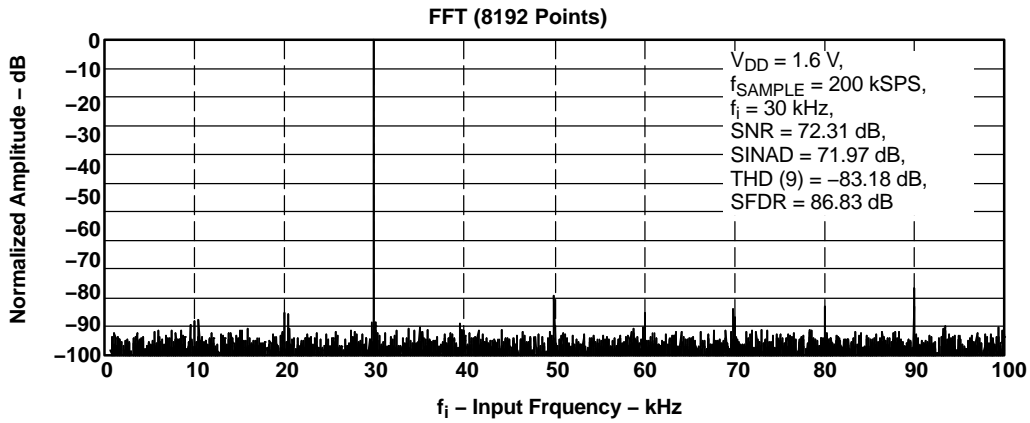

Figure 2.

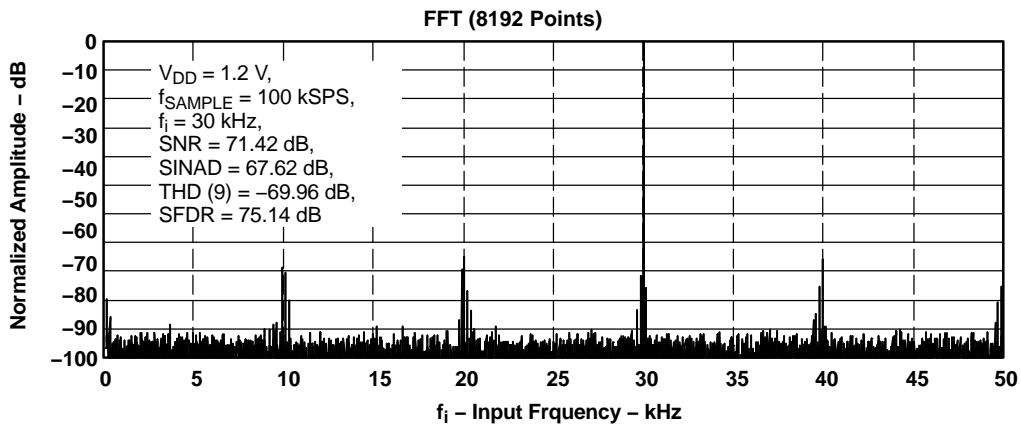

Figure 3.

**SIGNAL-TO-NOISE RATIO vs INPUT FREQUENCY**

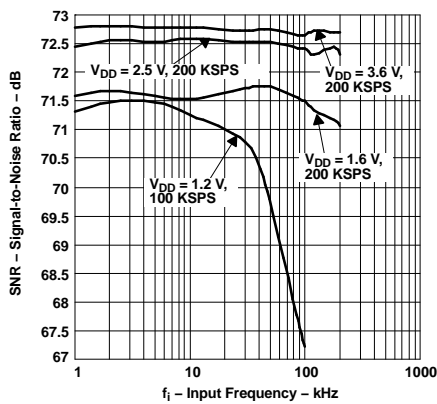

Figure 4.

**SIGNAL-TO-NOISE AND DISTORTION vs INPUT FREQUENCY**

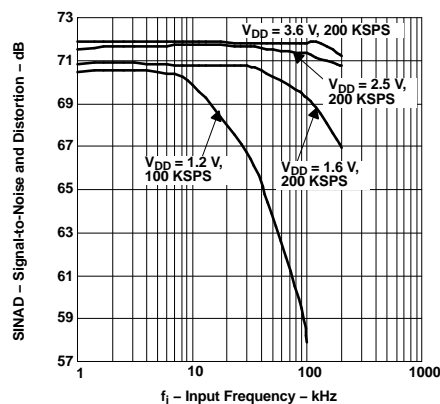

Figure 5.

**TOTAL HARMONIC DISTORTION vs INPUT FREQUENCY**

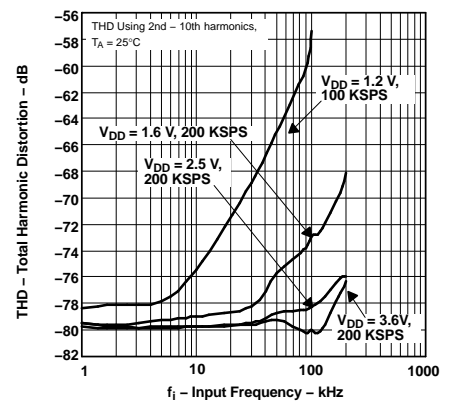

Figure 6.

TYPICAL CHARACTERISTICS ADS7866 (continued)

SPURIOUS FREE DYNAMIC RANGE  
 VS  
 INPUT FREQUENCY

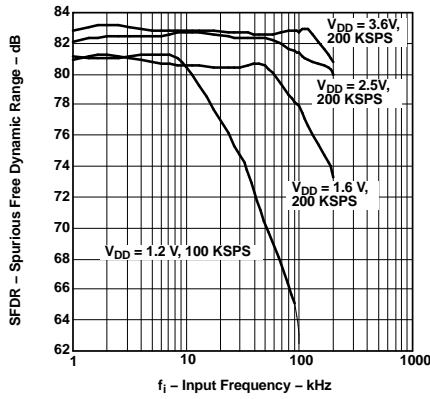

Figure 7.

SUPPLY CURRENT  
 VS  
 SCLK FREQUENCY

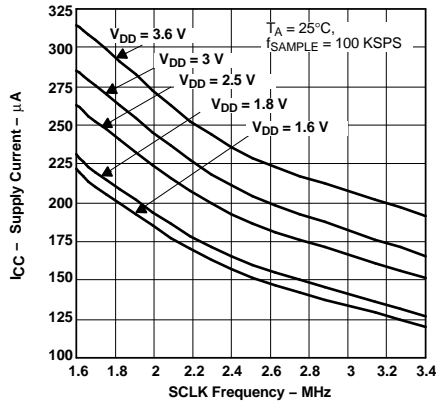

Figure 8.

SUPPLY CURRENT  
 VS  
 SUPPLY VOLTAGE

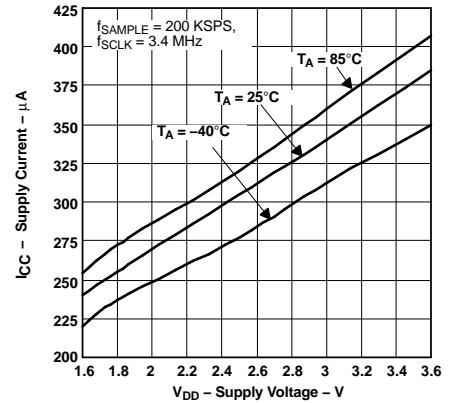

Figure 9.

POWER CONSUMPTION  
 VS  
 THROUGHPUT

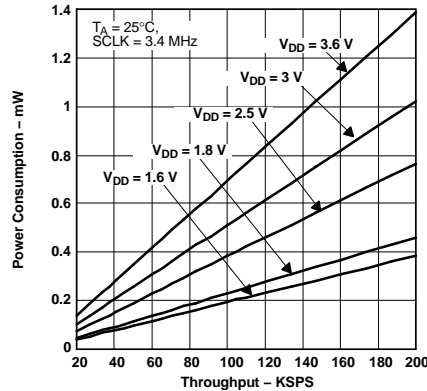

Figure 10.

TOTAL HARMONIC DISTORTION  
 VS  
 INPUT FREQUENCY

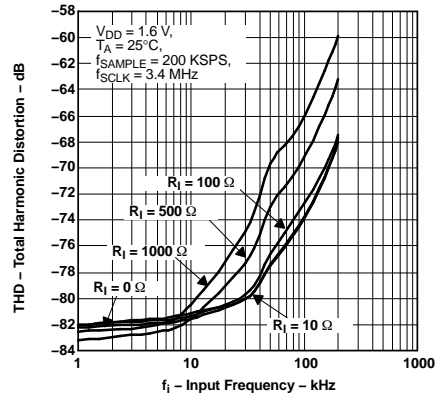

Figure 11.

INL

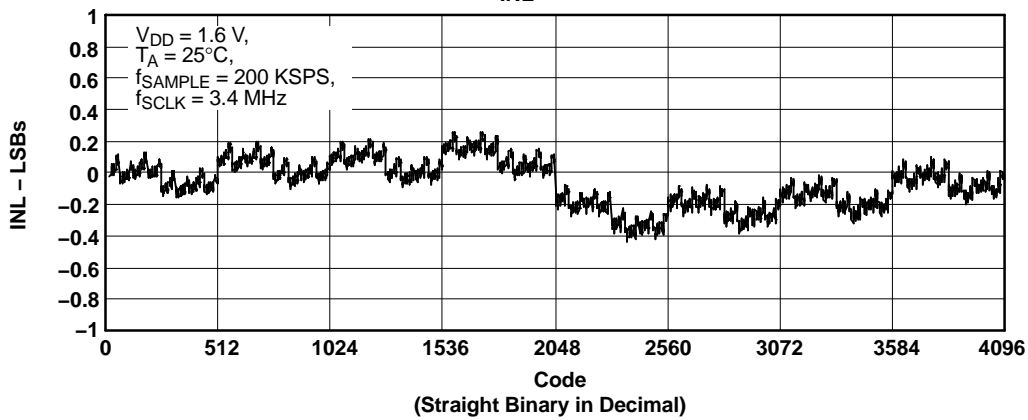

Figure 12.

**TYPICAL CHARACTERISTICS ADS7866 (continued)**

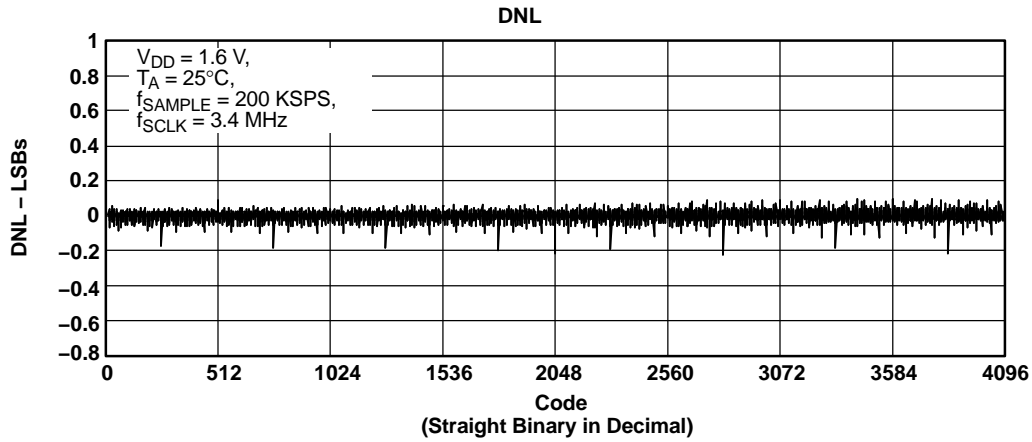

Figure 13.

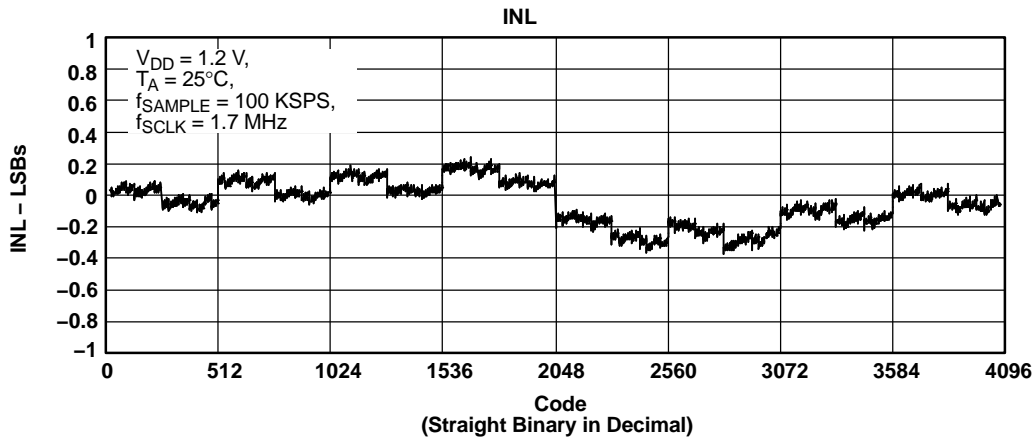

Figure 14.

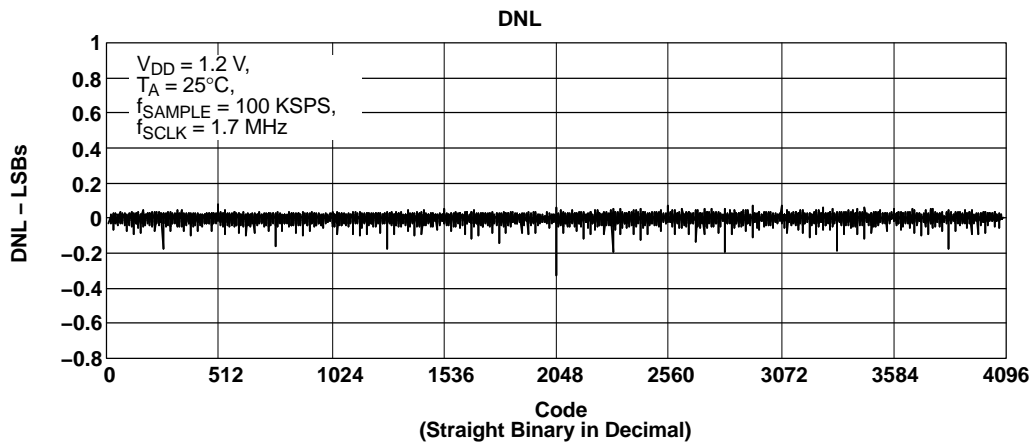

Figure 15.

TYPICAL CHARACTERISTICS ADS7866 (continued)

MAX SUPPLY CURRENT  
 VS  
 SUPPLY VOLTAGE

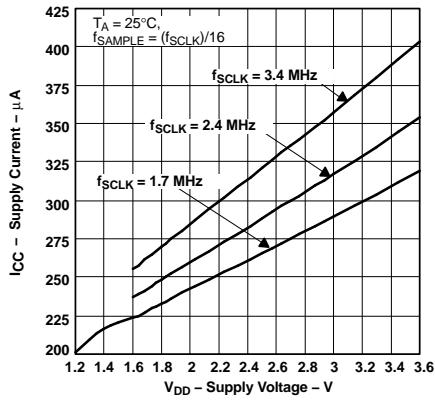

Figure 16.

THROUGHPUT RATE  
 VS  
 SUPPLY VOLTAGE

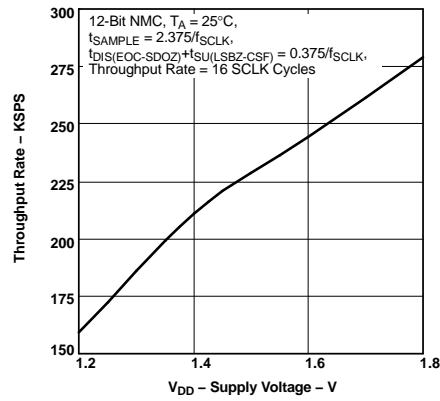

Figure 17.

THROUGHPUT RATE  
 VS  
 SUPPLY VOLTAGE

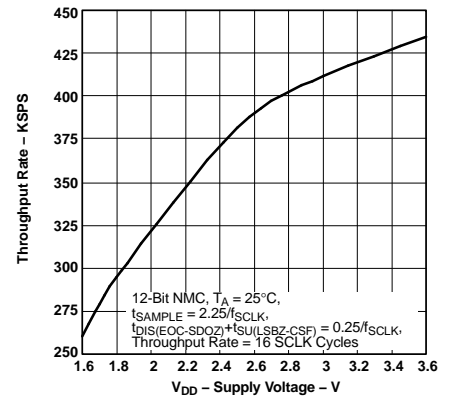

Figure 18.

**TYPICAL CHARACTERISTICS ADS7867**

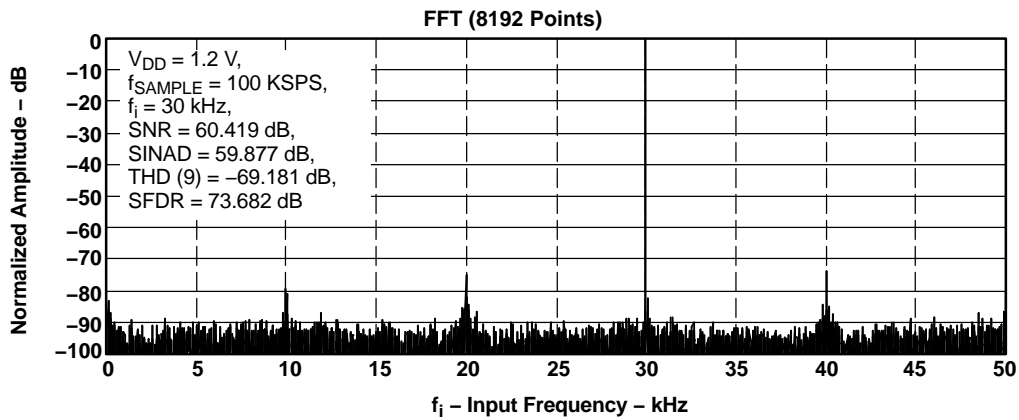

Figure 19.

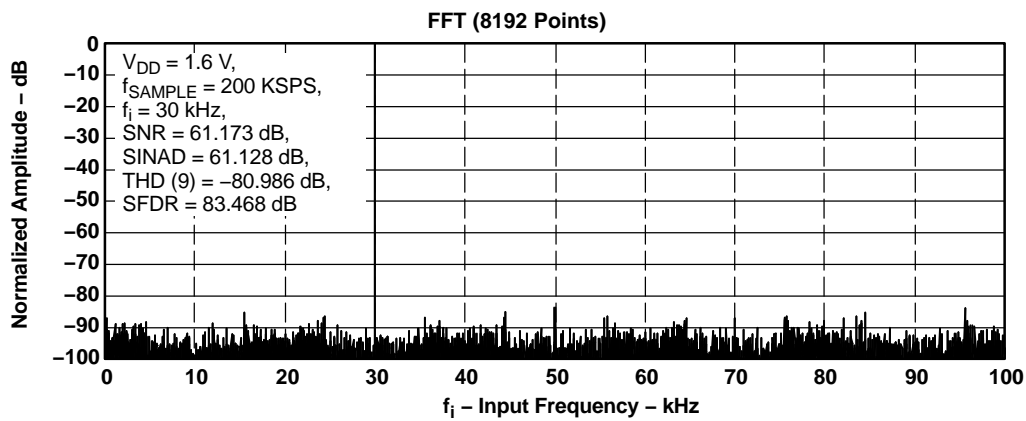

Figure 20.

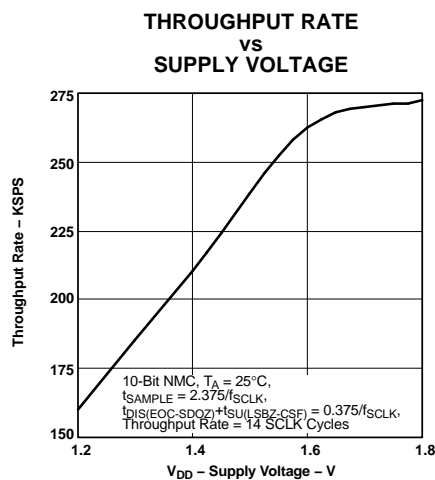

Figure 21.

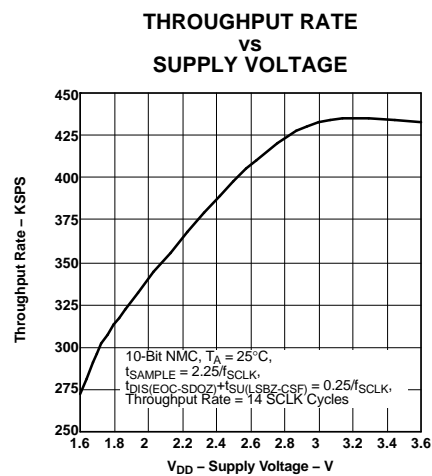

Figure 22.

**TYPICAL CHARACTERISTICS ADS7868**

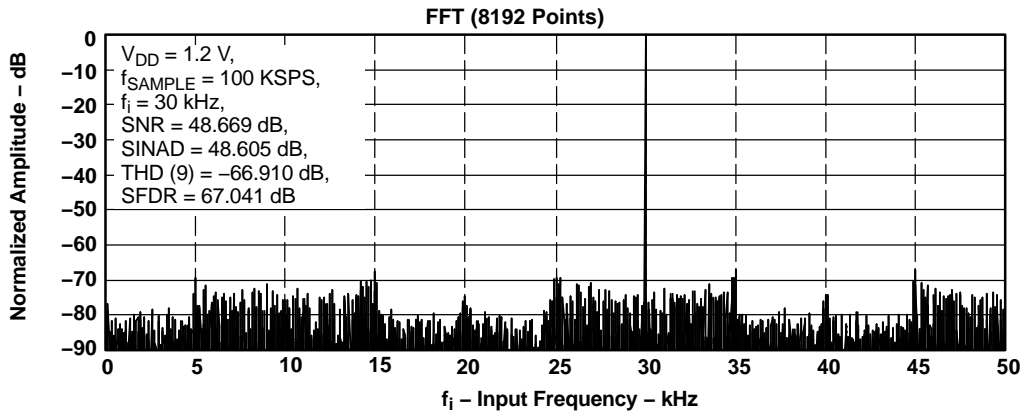

Figure 23.

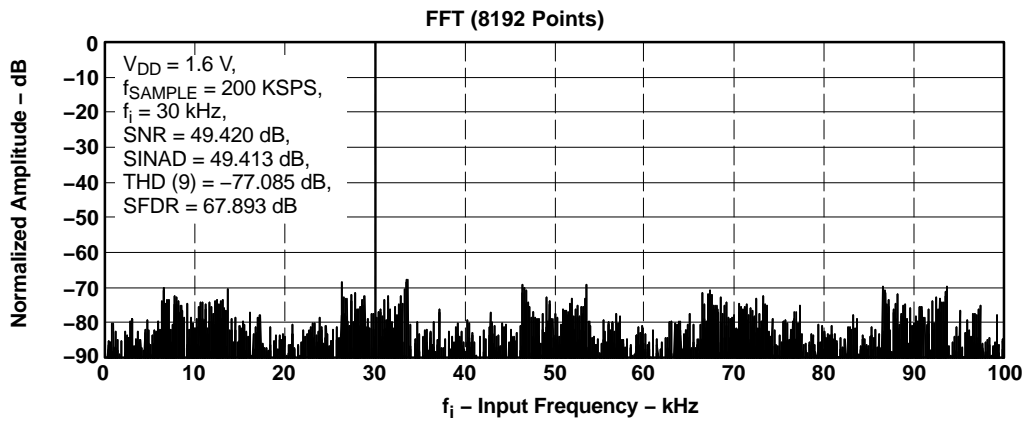

Figure 24.

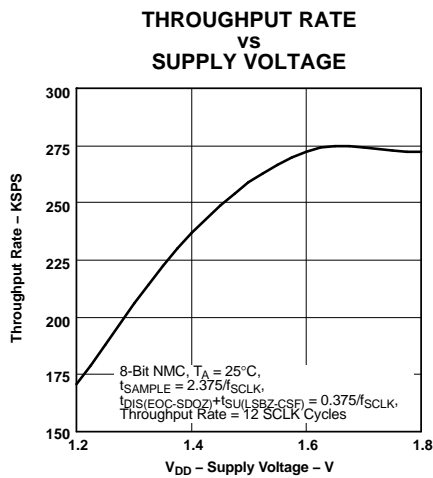

Figure 25.

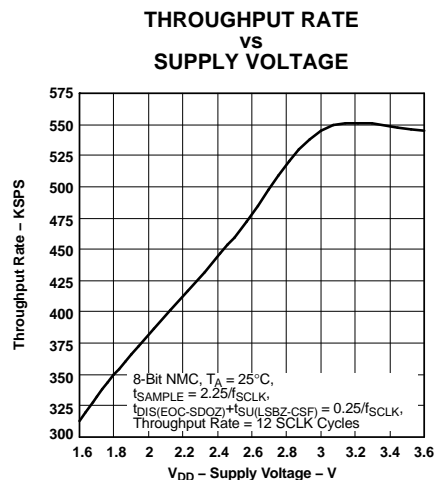

Figure 26.

## THEORY OF OPERATION

The ADS7866/67/68 is a family of low supply voltage, low power, high-speed successive approximation register (SAR) analog-to-digital converters (ADCs). The devices can be operated from a supply range from 1.2 V to 3.6 V. There is no need for an external reference. The reference is derived internally from the supply voltage, so the analog input range can be from 0 V to  $V_{DD}$ . These ADCs use a charge redistribution architecture, which inherently includes a sample/hold function.

### START OF A CONVERSION CYCLE

A conversion cycle is initiated by bringing the  $\overline{CS}$  pin low and supplying the serial clock SCLK. The time between the falling edge of  $\overline{CS}$  and the third falling edge of SCLK after  $\overline{CS}$  falls is used to acquire the input signal. This must be greater than or equal to the minimum acquisition time (MIN  $t_{SAMPLE}$  in [Table 1](#)) specified for the desired resolution and supply voltage. On the third falling edge of SCLK after  $\overline{CS}$  falls, the device goes into hold mode and the process of digitizing the sampled input signal starts.

### Acquisition Time, Conversion Time, and Total Cycle Time

The maximum SCLK frequency is determined by the minimum acquisition time (MIN  $t_{SAMPLE}$ ) specified for the specific resolution and supply voltage of the device. The conversion time is determined by the frequency of SCLK since this is a synchronous converter. The conversion time is 13 times the SCLK cycle time  $t_{C(SCLK)}$  for the ADS7866, 11 times for the ADS7867, and 9 times for the ADS7868. The acquisition time, which is also the power up time, is the set-up time between the first falling edge of SCLK after  $\overline{CS}$  falls ( $t_{SU(CSF-FSCLKF)}$ ) plus 2 times  $t_{C(SCLK)}$ .

The total cycle time,  $t_{CYCLE}$ , which is the inverse of the maximum sample rate, can be calculated as follows:

$$\begin{aligned}
 t_{CYCLE} &= t_{SAMPLE} + t_{CONVERT} + 0.5 \times t_{C(SCLK)} \\
 &\quad \text{if } t_{DIS(EOC-SDOZ)} + t_{SU(LSBZ-CSF)} \leq 0.5 \times t_{C(SCLK)} \\
 t_{CYCLE} &= t_{SAMPLE} + t_{CONVERT} + t_{DIS(EOC-SDOZ)} + t_{SU(LSBZ-CSF)} \\
 &\quad \text{if } t_{DIS(EOC-SDOZ)} + t_{SU(LSBZ-CSF)} > 0.5 \times t_{C(SCLK)}
 \end{aligned}$$

**THEORY OF OPERATION (continued)**

**Table 1. Acquisition, Conversion, SCLK, and Potential Throughput Calculation**

PARAMETER		SUPPLY VOLTAGE	ADS7866	ADS7867	ADS7868	UNIT
MIN $t_{SU(CSF-FSCLKF)}$	Setup time	$1.2\text{ V} \leq V_{DD} < 1.6\text{ V}$	192	192	192	ns
		$1.6\text{ V} \leq V_{DD} < 1.8\text{ V}$	55	55	55	
		$1.8\text{ V} \leq V_{DD} \leq 3.6\text{ V}$	55	55	55	
MAX $t_{DIS(EOC-SDOZ)}$	Disable time	$1.2\text{ V} \leq V_{DD} < 1.6\text{ V}$	80	80	80	ns
		$1.6\text{ V} \leq V_{DD} < 1.8\text{ V}$	60	60	60	
		$1.8\text{ V} \leq V_{DD} \leq 3.6\text{ V}$	60	60	60	
MIN $t_{SU(LSBZ-CSF)}$	Setup time	$1.2\text{ V} \leq V_{DD} < 1.6\text{ V}$	20	20	20	ns
		$1.6\text{ V} \leq V_{DD} < 1.8\text{ V}$	10	10	10	
		$1.8\text{ V} \leq V_{DD} \leq 3.6\text{ V}$	10	10	10	
MAX $f_{SCLK}$	Frequency	$1.2\text{ V} \leq V_{DD} < 1.6\text{ V}$	1.7	1.7	1.7	MHz
		$1.6\text{ V} \leq V_{DD} < 1.8\text{ V}$	3.4	3.4	3.4	
		$1.8\text{ V} \leq V_{DD} \leq 3.6\text{ V}$	3.4	3.4	3.4	
MIN $t_{sample}$	Sample time	$1.2\text{ V} \leq V_{DD} < 1.6\text{ V}$	1368	1368	1368	ns
		$1.6\text{ V} \leq V_{DD} < 1.8\text{ V}$	643	643	643	
		$1.8\text{ V} \leq V_{DD} \leq 3.6\text{ V}$	643	643	643	
MIN $t_{convert}$	Conversion time	$1.2\text{ V} \leq V_{DD} < 1.6\text{ V}$	7647	6471	5294	ns
		$1.6\text{ V} \leq V_{DD} < 1.8\text{ V}$	3824	3235	2647	
		$1.8\text{ V} \leq V_{DD} \leq 3.6\text{ V}$	3824	3235	2647	
MIN $t_{CYCLE}$	Cycle time	$1.2\text{ V} \leq V_{DD} < 1.6\text{ V}$	9116	7939	6763	ns
		$1.6\text{ V} \leq V_{DD} < 1.8\text{ V}$	4537	3949	3360	
		$1.8\text{ V} \leq V_{DD} \leq 3.6\text{ V}$	4537	3949	3360	
$f_{sample}$	Theoretical sample frequency	$1.2\text{ V} \leq V_{DD} < 1.6\text{ V}$	110	126	148	KSPS
		$1.6\text{ V} \leq V_{DD} < 1.8\text{ V}$	220	253	298	
		$1.8\text{ V} \leq V_{DD} \leq 3.6\text{ V}$	220	253	298	

**TYPICAL CONNECTION**

For a typical connection circuit for the ADS7866/67/68 see [Figure 27](#). A REF3112 is used to supply 1.2 V to the device. A 0.1- $\mu\text{F}$  decoupling capacitor is required between the REF/ $V_{DD}$  and GND pins of the converter. This capacitor should be placed as close as possible to the pins of the device. Designers should strive to minimize the routing length of the traces that connect the terminals of the capacitor to the pins of the converter.

Keep in mind the converter offers no inherent rejection of noise or voltage variation in regards to the reference input. This is of particular concern because the reference input is tied to the power supply. Any noise and ripple from the supply appears directly in the digital results. While high frequency noise can be filtered out as described in the previous paragraph, voltage variation due to the line frequency (50 Hz or 60 Hz) can be difficult to remove.

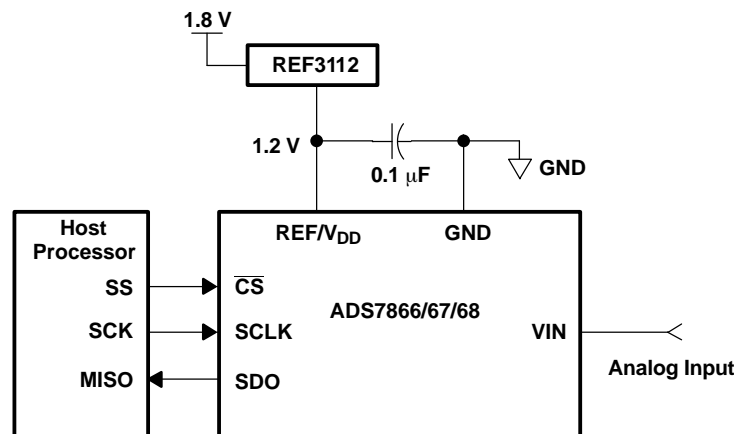

**Figure 27. Typical Circuit Configuration**

## ANALOG INPUT

Figure 28 shows the analog input equivalent circuit for the ADS7866/67/68. The analog input is provided between the VIN and GND pins. When a conversion is initiated, the input signal is sampled on the internal capacitor array. When the converter enters hold mode, the input signal is captured on the internal capacitor array. The VIN input range is limited to 0 V to  $V_{DD}$  because the reference is derived from the supply.

The current flowing into the analog input depends upon a number of factors, such as the sample rate, the input voltage, and the input source impedance. The current from the input source charges the internal capacitor array during the sample period. After this capacitance has been fully charged, there is no further input current. The source of the analog input voltage must be able to charge the input capacitance  $C_S$  (12 pF typical) within the minimum acquisition time (MIN  $t_{SAMPLE}$ ) specified for the desired resolution and supply voltage. In the case of the ADS7866, the MIN  $t_{SAMPLE}$  for 12-bit resolution is 643 ns ( $V_{DD}$  between 1.6 V and 3.6 V). When the converter goes into hold mode, the input impedance is greater than 1 G $\Omega$ .

Care must be taken regarding the absolute analog input voltage. In order to maintain the linearity of the converter, the span ( $V_{IN} - GND$ ) should be within the limits specified. Outside of these limits, the converter's linearity may not meet specifications. Noise introduced into the converter from the input source may be minimized by using low bandwidth input signals along with low-pass filters.

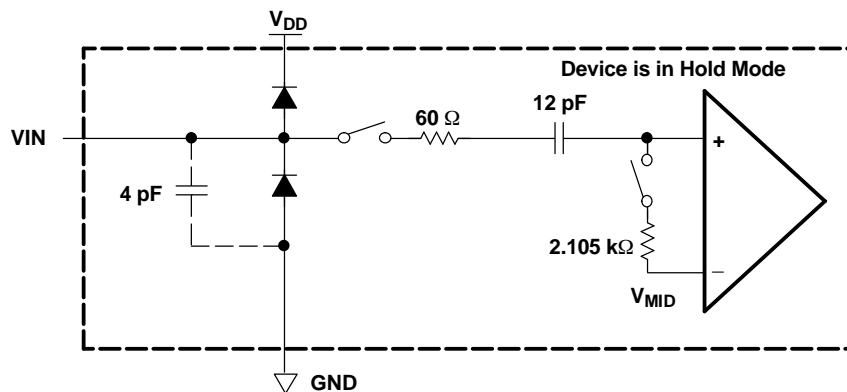

Figure 28. Analog Input Equivalent Circuit (Typical Impedance Values at  $V_{DD} = 1.6$  V,  $T_A = 27^\circ\text{C}$ )

### Choice of Input Driving Amplifier

The analog input to the converter needs to be driven with a low noise, low voltage op amp like the OPA364 or OPA333. An RC filter is recommended at the input pin to low-pass filter the noise from the source. The input to the converter is a unipolar input voltage in the range 0 V to  $V_{DD}$ .

## DIGITAL INTERFACE

The ADS7866/67/68 interface with microprocessors or DSPs through a high-speed SPI compatible serial interface with CPOL = 1 (inactive SCLK returns to logic high or SCLK leading edge is the rising edge), CPHA = 1 (output data changes on falling edge of SCLK and is available on the rising edge of SCLK). The sampling, conversion, and activation of SDO are initiated on the falling edge of  $\overline{CS}$ . The serial clock (SCLK) is used for controlling the rate of conversion. It also provides a mechanism allowing synchronization with digital host processors.

The digital inputs,  $\overline{CS}$  and SCLK, can exceed the supply voltage  $V_{DD}$  as long as they do not exceed the maximum  $V_{IH}$  of 3.6 V. This allows the ADS7866/67/68 family to interface with host processors which use a different supply voltage than the converter without requiring external level-shifting circuitry. Furthermore, the digital inputs can be applied to  $\overline{CS}$  and SCLK before the supply voltage of the converter is activated without the risk of creating a latch-up condition.

### Conversion Result

The ADS7866/67/68 outputs 12/10/8-bit data after 4 leading zeros, respectively. These codes are in straight binary format as shown in Table 2.

The serial output SDO is activated on the falling edge of  $\overline{CS}$ . The first leading zero is available on SDO until the first falling edge of SCLK after  $\overline{CS}$  falls. The remaining 3 leading zeros are shifted out on SDO on the first, second, and third falling edges of SCLK after  $\overline{CS}$  falls. The MSB of the converted result follows 4 leading zeros and is clocked out on the fourth falling edge of SCLK. The rising edge of  $\overline{CS}$  or the falling edge of SCLK when the EOC occurs puts SDO output into 3-state. Refer to [Table 2](#) for ideal output codes versus input voltages.

**Table 2. ADS7866/67/68 Ideal Output Codes Versus Input Voltages**

DESCRIPTION	ANALOG INPUT VOLTAGE	DIGITAL OUTPUT STRAIGHT BINARY	
		BINARY CODE	HEX CODE
<b>ADS7866</b>			
Least Significant Bit (LSB)	$V_{DD}/4096$		
Full Scale	$V_{DD} - 1\text{LSB}$	1111 1111 1111	FFF
Midscale	$V_{DD}/2$	1000 0000 0000	800
Midscale – 1LSB	$V_{DD}/2 - 1\text{LSB}$	0111 1111 1111	7FF
Zero	0V	0000 0000 0000	000
<b>ADS7867</b>			
Least Significant Bit (LSB)	$V_{DD}/1024$		
Full Scale	$V_{DD} - 1\text{LSB}$	11 1111 1111	3FF
Midscale	$V_{DD}/2$	10 0000 0000	200
Midscale – 1LSB	$V_{DD}/2 - 1\text{LSB}$	01 1111 1111	1FF
Zero	0V	00 0000 0000	000
<b>ADS7868</b>			
Least Significant Bit (LSB)	$V_{DD}/256$		
Full Scale	$V_{DD} - 1\text{LSB}$	1111 1111	FF
Midscale	$V_{DD}/2$	1000 0000	80
Midscale – 1LSB	$V_{DD}/2 - 1\text{LSB}$	0111 1111	7F
Zero	0V	0000 0000	00

## POWER DISSIPATION

The ADS7866/67/68 family is capable of operating with very low supply voltages while drawing a fraction of a milliamp. Furthermore, there is an auto power-down mode to reduce the power dissipation between conversion cycles. Carefully selected system design can take advantage of these features to achieve optimum power performance.

### Auto Power-Down Mode

The ADS7866/67/68 family has an auto power-down feature. Besides powering down all circuitry, the converter consumes only 8 nA typically in this mode. The device automatically wakes up when  $\overline{CS}$  falls. However, not all of the functional blocks are fully powered until sometime before the third falling edge of SCLK. The device powers down once it reaches the end of conversion (EOC) which is the 16th falling edge of SCLK for the ADS7866 (the 14th and 12th for the ADS7867 and ADS7868, respectively). If  $\overline{CS}$  is pulled high before the device reaches the EOC, the converter goes into power-down mode and the ongoing conversion is aborted. Refer to the timing diagram in [Figure 1](#) for further information.

### Power Saving: SCLK Frequency and Throughput

These converters achieve lower power dissipation for a fixed throughput rate  $f_{\text{sample}} = 1/t_{\text{cycle}}$  by using higher SCLK frequencies. Higher SCLK frequencies reduce the acquisition time ( $t_{\text{sample}}$ ) and conversion time ( $t_{\text{convert}}$ ). This means the converters spend more time in auto power-down mode per conversion cycle. This can be observed in [Figure 8](#) which shows the ADS7866 supply current versus SCLK frequency for  $f_{\text{sample}} = 100$  KSPS. For a particular SCLK frequency, the acquisition time and conversion time are fixed. Therefore, a lower throughput increases the proportion of the time the converters are in power down. [Figure 10](#) shows this case for the ADS7866 power consumption versus throughput rate for  $f_{\text{SCLK}} = 3.4$  MHz.

### Power-On Initialization

There is no specific initialization requirement for these converters after power-on, but the first conversion might not yield a valid result. In order to set the converter in a known state,  $\overline{CS}$  should be toggled low then high after  $V_{DD}$  has stabilized during power-on. By doing this, the converter is placed in auto power-down mode, and the serial data output (SDO) is 3-stated.

**PACKAGING INFORMATION**

Orderable Device	Status (1)	Package Type	Package Drawing	Pins	Package Qty	Eco Plan (2)	Lead/Ball Finish (6)	MSL Peak Temp (3)	Op Temp (°C)	Device Marking (4/5)	Samples
ADS7866IDBVR	ACTIVE	SOT-23	DBV	6	3000	Green (RoHS & no Sb/Br)	CU NIPDAU	Level-2-260C-1 YEAR	-40 to 85	A66Y	<a href="#">Samples</a>
ADS7866IDBVRG4	ACTIVE	SOT-23	DBV	6	3000	Green (RoHS & no Sb/Br)	CU NIPDAU	Level-2-260C-1 YEAR	-40 to 85	A66Y	<a href="#">Samples</a>
ADS7866IDBVT	ACTIVE	SOT-23	DBV	6	250	Green (RoHS & no Sb/Br)	CU NIPDAU	Level-2-260C-1 YEAR	-40 to 85	A66Y	<a href="#">Samples</a>
ADS7866IDBVTG4	ACTIVE	SOT-23	DBV	6	250	Green (RoHS & no Sb/Br)	CU NIPDAU	Level-2-260C-1 YEAR	-40 to 85	A66Y	<a href="#">Samples</a>
ADS7867IDBVR	ACTIVE	SOT-23	DBV	6	3000	Green (RoHS & no Sb/Br)	CU NIPDAU	Level-2-260C-1 YEAR	-40 to 85	A67Y	<a href="#">Samples</a>
ADS7867IDBVT	ACTIVE	SOT-23	DBV	6	250	Green (RoHS & no Sb/Br)	CU NIPDAU	Level-2-250C-1 YEAR	-40 to 85	A67Y	<a href="#">Samples</a>
ADS7868IDBVR	ACTIVE	SOT-23	DBV	6	3000	Green (RoHS & no Sb/Br)	CU NIPDAU	Level-2-260C-1 YEAR	-40 to 85	A68Y	<a href="#">Samples</a>
ADS7868IDBVT	ACTIVE	SOT-23	DBV	6	250	Green (RoHS & no Sb/Br)	CU NIPDAU	Level-2-260C-1 YEAR	-40 to 85	A68Y	<a href="#">Samples</a>
ADS7868IDBVTG4	ACTIVE	SOT-23	DBV	6	250	Green (RoHS & no Sb/Br)	CU NIPDAU	Level-2-260C-1 YEAR	-40 to 85	A68Y	<a href="#">Samples</a>

(1) The marketing status values are defined as follows:

**ACTIVE:** Product device recommended for new designs.

**LIFEBUY:** TI has announced that the device will be discontinued, and a lifetime-buy period is in effect.

**NRND:** Not recommended for new designs. Device is in production to support existing customers, but TI does not recommend using this part in a new design.

**PREVIEW:** Device has been announced but is not in production. Samples may or may not be available.

**OBSOLETE:** TI has discontinued the production of the device.

(2) **RoHS:** TI defines "RoHS" to mean semiconductor products that are compliant with the current EU RoHS requirements for all 10 RoHS substances, including the requirement that RoHS substance do not exceed 0.1% by weight in homogeneous materials. Where designed to be soldered at high temperatures, "RoHS" products are suitable for use in specified lead-free processes. TI may reference these types of products as "Pb-Free".

**RoHS Exempt:** TI defines "RoHS Exempt" to mean products that contain lead but are compliant with EU RoHS pursuant to a specific EU RoHS exemption.

**Green:** TI defines "Green" to mean the content of Chlorine (Cl) and Bromine (Br) based flame retardants meet JS709B low halogen requirements of <=1000ppm threshold. Antimony trioxide based flame retardants must also meet the <=1000ppm threshold requirement.

(3) MSL, Peak Temp. - The Moisture Sensitivity Level rating according to the JEDEC industry standard classifications, and peak solder temperature.

(4) There may be additional marking, which relates to the logo, the lot trace code information, or the environmental category on the device.

(5) Multiple Device Markings will be inside parentheses. Only one Device Marking contained in parentheses and separated by a "~" will appear on a device. If a line is indented then it is a continuation of the previous line and the two combined represent the entire Device Marking for that device.

(6) Lead/Ball Finish - Orderable Devices may have multiple material finish options. Finish options are separated by a vertical ruled line. Lead/Ball Finish values may wrap to two lines if the finish value exceeds the maximum column width.

**Important Information and Disclaimer:**The information provided on this page represents TI's knowledge and belief as of the date that it is provided. TI bases its knowledge and belief on information provided by third parties, and makes no representation or warranty as to the accuracy of such information. Efforts are underway to better integrate information from third parties. TI has taken and continues to take reasonable steps to provide representative and accurate information but may not have conducted destructive testing or chemical analysis on incoming materials and chemicals. TI and TI suppliers consider certain information to be proprietary, and thus CAS numbers and other limited information may not be available for release.

In no event shall TI's liability arising out of such information exceed the total purchase price of the TI part(s) at issue in this document sold by TI to Customer on an annual basis.

# DBV0006A



# PACKAGE OUTLINE

SOT-23 - 1.45 mm max height

SMALL OUTLINE TRANSISTOR



4214840/B 03/2018

**NOTES:**

1. All linear dimensions are in millimeters. Any dimensions in parenthesis are for reference only. Dimensioning and tolerancing per ASME Y14.5M.
2. This drawing is subject to change without notice.
3. Body dimensions do not include mold flash or protrusion. Mold flash and protrusion shall not exceed 0.15 per side.
4. Leads 1,2,3 may be wider than leads 4,5,6 for package orientation.
5. Reference JEDEC MO-178.

# EXAMPLE BOARD LAYOUT

DBV0006A

SOT-23 - 1.45 mm max height

SMALL OUTLINE TRANSISTOR



LAND PATTERN EXAMPLE  
EXPOSED METAL SHOWN  
SCALE:15X



SOLDER MASK DETAILS

4214840/B 03/2018

NOTES: (continued)

- 6. Publication IPC-7351 may have alternate designs.
- 7. Solder mask tolerances between and around signal pads can vary based on board fabrication site.

# EXAMPLE STENCIL DESIGN

DBV0006A

SOT-23 - 1.45 mm max height

SMALL OUTLINE TRANSISTOR



SOLDER PASTE EXAMPLE  
BASED ON 0.125 mm THICK STENCIL  
SCALE:15X

4214840/B 03/2018

NOTES: (continued)

8. Laser cutting apertures with trapezoidal walls and rounded corners may offer better paste release. IPC-7525 may have alternate design recommendations.
9. Board assembly site may have different recommendations for stencil design.

## IMPORTANT NOTICE AND DISCLAIMER

TI PROVIDES TECHNICAL AND RELIABILITY DATA (INCLUDING DATASHEETS), DESIGN RESOURCES (INCLUDING REFERENCE DESIGNS), APPLICATION OR OTHER DESIGN ADVICE, WEB TOOLS, SAFETY INFORMATION, AND OTHER RESOURCES "AS IS" AND WITH ALL FAULTS, AND DISCLAIMS ALL WARRANTIES, EXPRESS AND IMPLIED, INCLUDING WITHOUT LIMITATION ANY IMPLIED WARRANTIES OF MERCHANTABILITY, FITNESS FOR A PARTICULAR PURPOSE OR NON-INFRINGEMENT OF THIRD PARTY INTELLECTUAL PROPERTY RIGHTS.

These resources are intended for skilled developers designing with TI products. You are solely responsible for (1) selecting the appropriate TI products for your application, (2) designing, validating and testing your application, and (3) ensuring your application meets applicable standards, and any other safety, security, or other requirements. These resources are subject to change without notice. TI grants you permission to use these resources only for development of an application that uses the TI products described in the resource. Other reproduction and display of these resources is prohibited. No license is granted to any other TI intellectual property right or to any third party intellectual property right. TI disclaims responsibility for, and you will fully indemnify TI and its representatives against, any claims, damages, costs, losses, and liabilities arising out of your use of these resources.

TI's products are provided subject to TI's Terms of Sale ([www.ti.com/legal/termsofsale.html](http://www.ti.com/legal/termsofsale.html)) or other applicable terms available either on [ti.com](http://ti.com) or provided in conjunction with such TI products. TI's provision of these resources does not expand or otherwise alter TI's applicable warranties or warranty disclaimers for TI products.

Mailing Address: Texas Instruments, Post Office Box 655303, Dallas, Texas 75265  
Copyright © 2019, Texas Instruments Incorporated

## Looking for pricing, stock, or lifecycle information?

Click below to explore more details on WIN SOURCE:

 [View ADS7866IDBVR on WIN SOURCE](#)

 [Texas Instruments](#) Information

## Optimize Your Supply Chain with WIN SOURCE Solutions

-  Global Sourcing Solution
-  Obsolete Management
-  Cost Control Management
-  Shortage Management
-  Alternative Solution
-  Excess Inventory Management