



**THE DATASHEET OF
SMB10J6.0A**



SMAHS5.0A THRU SMAHS170A

List

List..... 1

Package outline..... 2

Features..... 2

Mechanical data..... 2

Maximum ratings 2

Electrical characteristics..... 3~4

Rating and characteristic curves..... 4~5

Pinning information..... 6

Marking..... 6

Suggested solder pad layout..... 6

Packing information..... 7

Reel packing..... 8

Suggested thermal profiles for soldering processes..... 8

High reliability test capabilities..... 9

SMAHS5.0A THRU SMAHS170A

400W Surface Mount Transient Voltage Suppressors 5.0V-170V

Features

- Uni-directional
- Very low profile - typical height of 1.0 mm
- 400W peak pulse power capability with a 10/1000µs waveform, repetition rate (duty cycle): 0.01%
- Excellent clamping capability
- Low incremental surge resistance
- Fast response time from 0V to VBR, typically less than 1 ps for uni-directional
- Lead-free parts meet RoHS requirements
- Suffix "-H" indicates Halogen-free part, ex. SMAHS5.0A-H

Mechanical data

- Epoxy:UL94-V0 rated flame retardant
- Case : Molded plastic,DO-221AC / SMA-HS
- Terminals : Solder plated, solderable per MIL-STD-750, Method 2026
- Polarity : Indicated by cathode band
- Mounting Position : Any
- Weight : Approximated 0.037 gram

Package outline

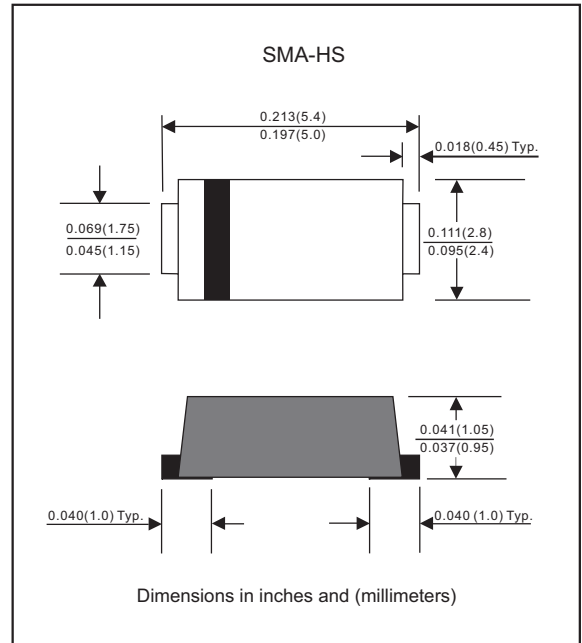

Maximum ratings (AT T_A=25°C unless otherwise noted)

Parameter	Conditions	Symbol	Value	Unit
Peak power dissipation	with a 10/1000µs waveform, Note 1, 2 & Fig. 1	PPPM	400	W
Peak pulse current	with a 10/1000µs waveform	I _{PPM}	See Table 1	A
Steady state power dissipation	at T _L =75°C, Note 2	P _{M(AV)}	2.0	W
Peak forward surge current	8.3ms single half sine-wave, Note 3	I _{FSM}	40	A
Maximum instantaneous forward voltage	at I _F =25A For uni-directional types only, Note 4	V _F	3.5/6.5	V
Typical thermal resistance	Junction to case Junction to ambient	R _{θJC} R _{θJA}	32 54	°C/W
Operating junction temperature range		T _J	-55 to +150	°C
Storage temperature range		T _{STG}	-65 to +175	°C

Notes 1. Non-repetitive current pulse, per Fig. 3 and derated above T_A=25°C per Fig. 2
 2. Mounted on copper pad area of minimum recommended pad layout per Fig 5
 3. Measured on 8.3 ms single half sine-wave or equivalent square wave, duty cycle=4 pulses per minute maximum
 4. V_F < 3.5V for V_{BR} < 200V and V_F < 6.5V for V_{BR} > 201V

Electrical characteristics (at $T_A=25^{\circ}\text{C}$ unless otherwise noted)

Part No. (Uni)	Reverse Stand-off Voltage	Breakdown Voltage @ I_T		Test Current	Maximum Clamping Voltage @ I_{PP}		Maximum Reverse Leakage Current	Marking Code
	V_{RWM}	$V_{BR\text{Min}}$	$V_{BR\text{Max}}$	I_T	V_c	I_{PP}	$I_R@V_{RWM}$	
	Volts	Volts	Volts	mA	Volts	A	μA	
SMAHS5.0A	5.0	6.40	7.00	10	9.2	43.5	800	AE
SMAHS6.0A	6.0	6.67	7.37	10	10.3	38.8	800	AG
SMAHS6.5A	6.5	7.22	7.98	10	11.2	35.7	500	AK
SMAHS7.0A	7.0	7.78	8.60	10	12.0	33.3	200	AM
SMAHS7.5A	7.5	8.33	9.21	1.0	12.9	31.0	100	AP
SMAHS8.0A	8.0	8.89	9.83	1.0	13.6	29.4	50	AR
SMAHS8.5A	8.5	9.44	10.4	1.0	14.4	27.7	20	AT
SMAHS9.0A	9.0	10.0	11.1	1.0	15.4	26.0	10	AV
SMAHS10A	10	11.1	12.3	1.0	17.0	23.5	5	AX
SMAHS11A	11	12.2	13.5	1.0	18.2	22.0	5	AZ
SMAHS12A	12	13.3	14.7	1.0	19.9	20.1	5	BE
SMAHS13A	13	14.4	15.9	1.0	21.5	18.6	5	BG
SMAHS14A	14	15.6	17.2	1.0	23.2	17.2	5	BK
SMAHS15A	15	16.7	18.5	1.0	24.4	16.4	5	BM
SMAHS16A	16	17.8	19.7	1.0	26.0	15.4	5	BP
SMAHS17A	17	18.9	20.9	1.0	27.6	14.5	5	BR
SMAHS18A	18	20.0	22.1	1.0	29.2	13.7	5	BT
SMAHS20A	20	22.2	24.5	1.0	32.4	12.3	5	BV
SMAHS22A	22	24.4	26.9	1.0	35.5	11.2	5	BX
SMAHS24A	24	26.7	29.5	1.0	38.9	10.3	5	BZ
SMAHS26A	26	28.9	31.9	1.0	42.1	9.5	5	CE
SMAHS28A	28	31.1	34.4	1.0	45.4	8.8	5	CG
SMAHS30A	30	33.3	36.8	1.0	48.4	8.3	5	CK
SMAHS33A	33	36.7	40.6	1.0	53.3	7.5	5	CM
SMAHS36A	36	40.0	44.2	1.0	58.1	6.9	5	CP
SMAHS40A	40	44.4	49.1	1.0	64.5	6.2	5	CR
SMAHS43A	43	47.8	52.8	1.0	69.4	5.7	5	CT
SMAHS45A	45	50.0	55.3	1.0	72.7	5.5	5	CV
SMAHS48A	48	53.3	58.9	1.0	77.4	5.1	5	CX
SMAHS51A	51	56.7	62.7	1.0	82.4	4.8	5	CZ
SMAHS54A	54	60.0	66.3	1.0	87.1	4.6	5	RE
SMAHS58A	58	64.4	71.2	1.0	93.6	4.3	5	RG
SMAHS60A	60	66.7	73.7	1.0	96.8	4.1	5	RK
SMAHS64A	64	71.1	78.6	1.0	103.0	3.8	5	RM
SMAHS70A	70	77.8	86.0	1.0	113.0	3.5	5	RP
SMAHS75A	75	83.3	92.1	1.0	121.0	3.3	5	RR
SMAHS78A	78	86.7	95.8	1.0	126.0	3.1	5	RT
SMAHS85A	85	94.4	104	1.0	137.0	2.9	5	RV

Electrical characteristics (at $T_A=25^{\circ}\text{C}$ unless otherwise noted)

Part No. (Uni)	Reverse Stand-off Voltage	Breakdown Voltage @ I_T		Test Current	Maximum Clamping Voltage @ I_{PP}		Maximum Reverse Leakage Current	Marking Code
	V_{RWM}	V_{BRMin}	V_{BRMax}	I_T	V_C	I_{PP}	$I_R@V_{RWM}$	
	Volts	Volts	Volts	mA	Volts	A	μA	
SMAHS90A	90	100	111	1.0	146.0	2.7	5	RX
SMAHS100A	100	111	123	1.0	162.0	2.4	5	RZ
SMAHS110A	110	122	135	1.0	177.0	2.2	5	SE
SMAHS120A	120	133	147	1.0	193.0	2.0	5	SG
SMAHS130A	130	144	159	1.0	209.0	1.9	5	SK
SMAHS150A	150	167	185	1.0	243.0	1.6	5	SM
SMAHS160A	160	178	197	1.0	259.0	1.5	5	SP
SMAHS170A	170	189	209	1.0	275.0	1.4	5	SR

- Notes 1. V_{BR} measured after I_T applied for $300\mu\text{s}$, I_T =square wave pulse or equivalent
 2. Surge current waveform per Fig. 3 and derated per Fig. 2
 3. Suffix 'A' denotes 5% tolerance devices
 4. All terms and symbols are consistent with ANS/IEEE C62.35
 5. Transient Voltage Suppressors (TVS) are devices used to protect vulnerable circuits from electrical overstress such as that caused by electrostatic discharge, inductive load switching and induced lightning. Within the TVS, damaging voltage spikes are limited by clamping or avalanche action of a rugged silicon pn junction which reduces the amplitude of the transient to a nondestructive level. See Fig. 7 & Fig. 8

Rating and characteristic curves (SMAHS SERIES)

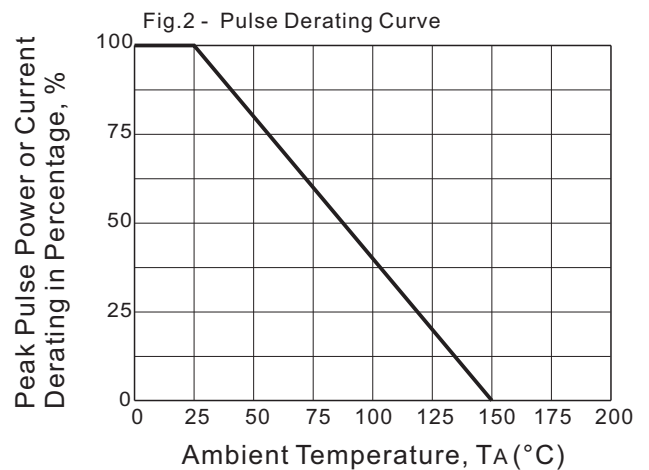
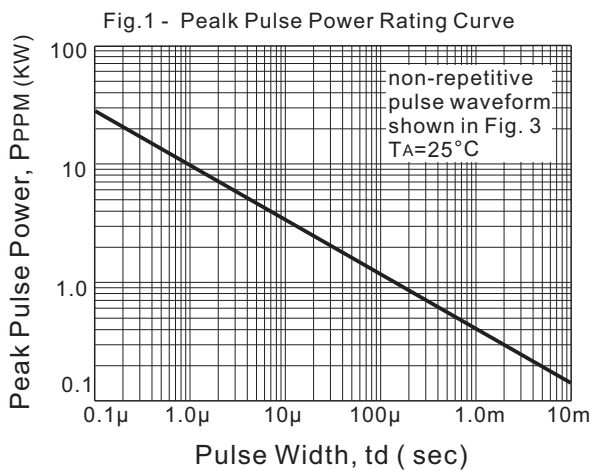

Rating and characteristic curves (SMAHS SERIES)

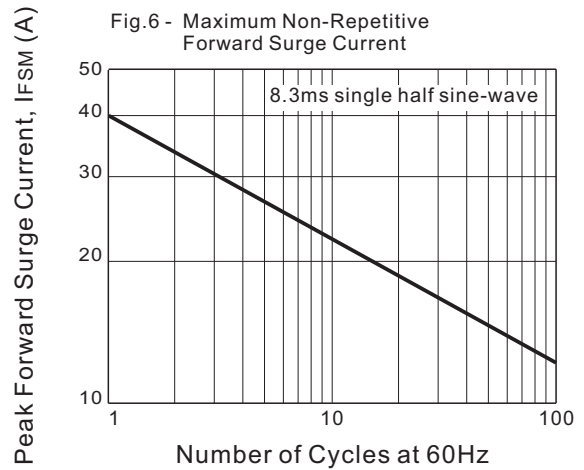
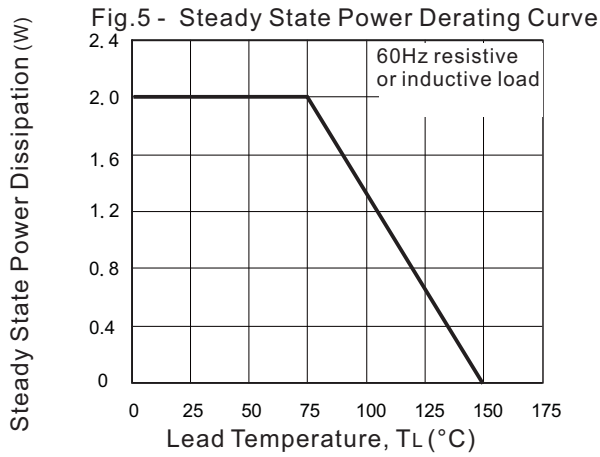
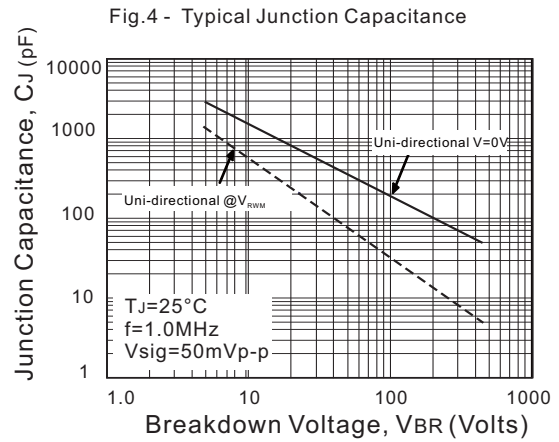
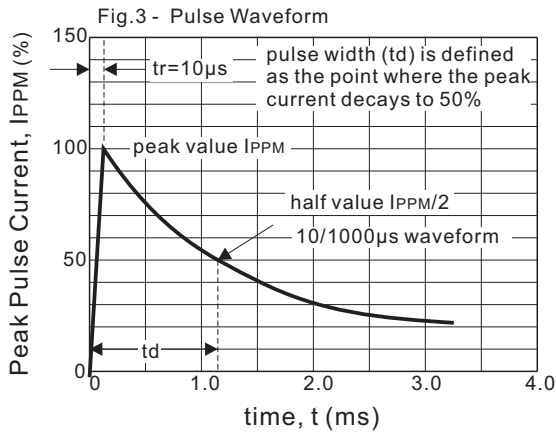

Fig. 7 - Transients of several thousand volts can be clamped to a safe level by the TVS

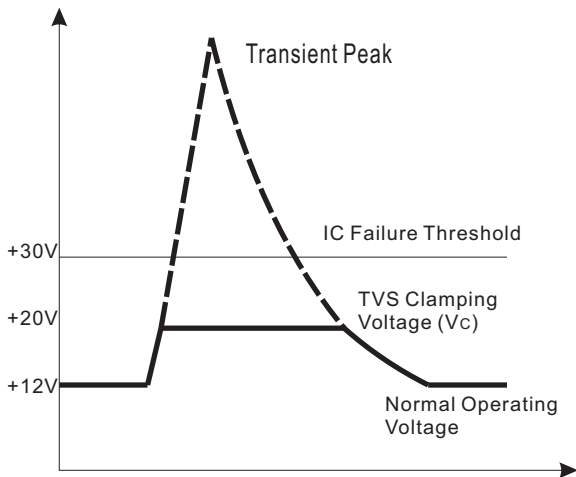
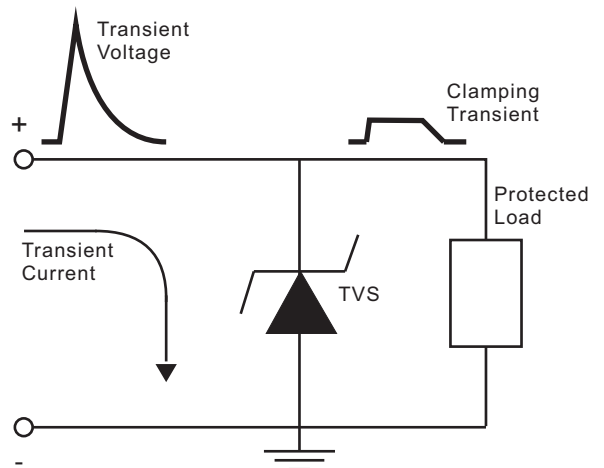



Fig. 8 - Transient current is diverted to ground thru TVS; the voltage seen by the protected load is limited to the clamping voltage level



SMAHS5.0A THRU SMAHS170A

Pinning information

Pin	Simplified outline	Symbol
Uni-Directional Pin1 cathode Pin2 anode		

Marking

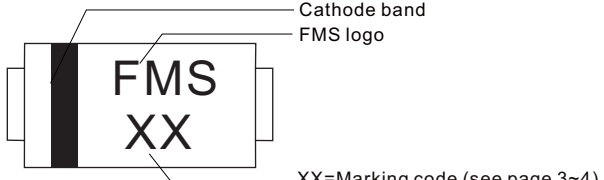
Type number	Example
Uni-Directional	

Suggested solder pad layout

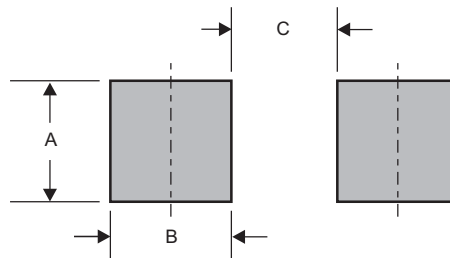

Dimensions in inches and (millimeters)

PACKAGE	A	B	C
SMA-HS	0.060 (1.52)	0.048 (1.20)	0.123 (3.12)

SMAHS5.0A THRU SMAHS170A

Packing information

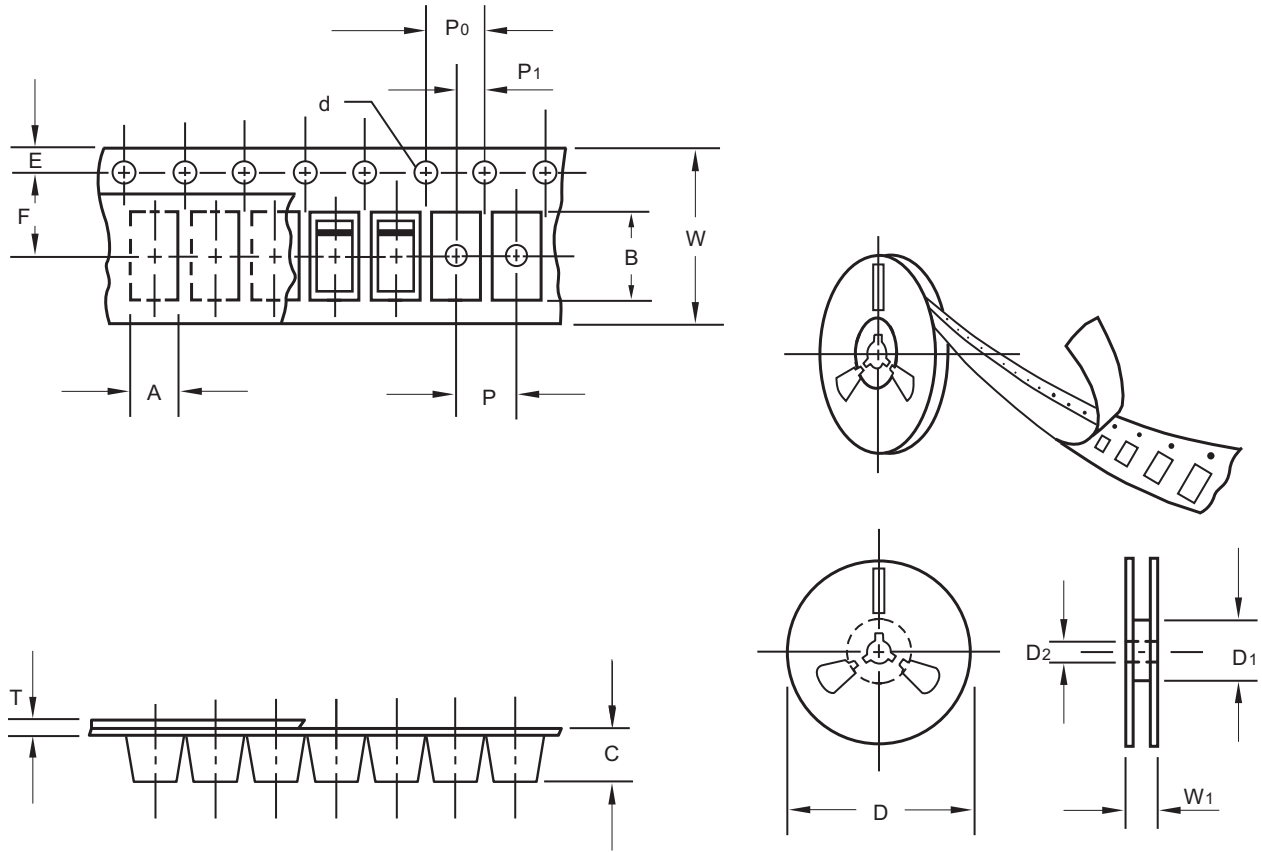

unit:mm

Item	Symbol	Tolerance	SMA-HS
Carrier width	A	0.1	3.00
Carrier length	B	0.1	5.50
Carrier depth	C	0.1	1.20
Sprocket hole	d	0.1	1.50
13" Reel outside diameter	D	2.0	330.00
13" Reel inner diameter	D1	min	50.00
7" Reel outside diameter	D	2.0	178.00
7" Reel inner diameter	D1	min	62.00
Feed hole diameter	D2	0.5	13.00
Sprocket hole position	E	0.1	1.75
Punch hole position	F	0.1	5.50
Punch hole pitch	P	0.1	4.00
Sprocket hole pitch	P0	0.1	4.00
Embossment center	P1	0.1	2.00
Overall tape thickness	T	0.1	0.25
Tape width	W	0.3	12.00
Reel width	W1	1.0	11.40

Note: Devices are packed in accordance with EIA standard RS-481-A and specifications listed above.

SMAHS5.0A THRU SMAHS170A

Reel packing

PACKAGE	REEL SIZE	REEL (pcs)	COMPONENT SPACING (m/m)	BOX (pcs)	INNER BOX (m/m)	REEL DIA, (m/m)	CARTON SIZE (m/m)	CARTON (pcs)	APPROX. GROSS WEIGHT (kg)
SMA-HS	7"	3,000	4.0	30,000	183*155*183	178	382*356*392	240,000	18.0
	13"	10,000	4.0	20,000	335*335*38	330	350*330*360	160,000	15.5

Suggested thermal profiles for soldering processes

- 1.Storage environment: Temperature=5°C~40°C Humidity=55%±25%
- 2.Reflow soldering of surface-mount devices

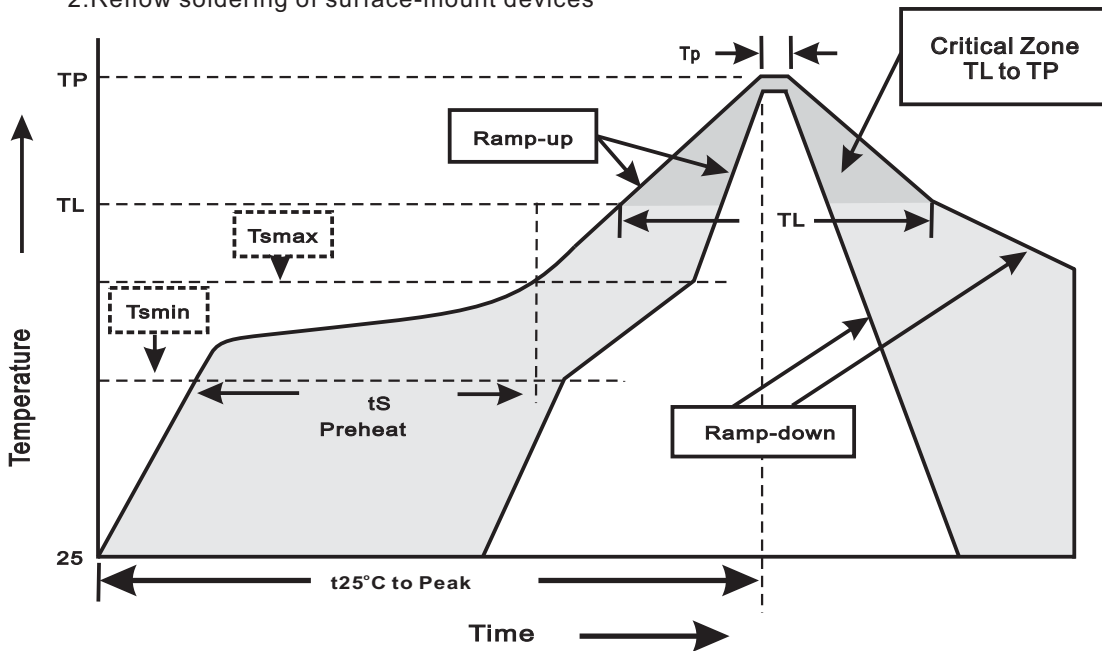

3.Reflow soldering

Profile Feature	Soldering Condition
Average ramp-up rate(TL to TP)	<3°C/sec
Preheat -Temperature Min(Tsmin) -Temperature Max(Tsmax) -Time(min to max)(ts)	150°C 200°C 60~120sec
Tsmax to TL -Ramp-upRate	<3°C/sec
Time maintained above: -Temperature(TL) -Time(tL)	217°C 60~260sec
Peak Temperature(TP)	255°C-0/+5°C
Time within 5°C of actual Peak Temperature(tP)	10~30sec
Ramp-down Rate	<6°C/sec
Time 25°C to Peak Temperature	<6minutes

SMAHS5.0A THRU SMAHS170A**High reliability test capabilities**

Item Test	Conditions	Reference
1. Solder Resistance	at 260±5°C for 10±2sec.	MIL-STD-750D METHOD-2031
2. Solderability	at 245±5°C for 5 sec.	MIL-STD-202F METHOD-208
3. High Temperature Reverse Bias	$V_{BR}=V_{BR\ NOM} * 80\%$ at $T_J=150^\circ\text{C}$ for 168 hrs.	MIL-STD-750D METHOD-1038
4. Pressure Cooker	15P _{SIG} at $T_A=121^\circ\text{C}$ for 4 hrs.	JESD22-A102
5. Temperature Cycling	-55°C to +125°C dwelled for 30 min. and transferred for 5min. total 10 cycles.	MIL-STD-750D METHOD-1051
6. Humidity	at $T_A=85^\circ\text{C}$, RH=85% for 1000hrs.	MIL-STD-750D METHOD-1021
7. High Temperature Storage Life	at 175°C for 1000 hrs.	MIL-STD-750D METHOD-1031

Looking for pricing, stock, or lifecycle information?

Click below to explore more details on WIN SOURCE:

- ⊖ [View SMB10J6.0A on WIN SOURCE](#)
- ⊖ [Formosa MS Information](#)

Optimize Your Supply Chain with WIN SOURCE Solutions

- ✓ Global Sourcing Solution
- ✓ Obsolete Management
- ✓ Cost Control Management
- ✓ Shortage Management
- ✓ Alternative Solution
- ✓ Excess Inventory Management