





THE DATASHEET OF SL1045



SPECIFICATION SHEET

SPECIFICATION SHEET NO.	P0115- TO277SL1045S45
DATE	Jan. 15, 2022
REVISION	A0
DESCRIPTION	SMD Schottky Barrier Rectifier, TO-277 series, SL1045 Type, Reverse Voltage 45V Max. Forward Current 10A Max. Operating Temp. Range -55°C ~+150°C, Package in Tape/Reel, 5000pcs/Reel RoHS/RoHS III compliant
CUSTOMER	
CUSTOMER PART NUMBER	
CROSS REF. PART NUMBER	
ORIGINAL PART NUMBER	MDD SL1045
PART CODE	TO277SL1045S45

VENDOR APPROVE			
Issued/Checked/Approved			
DATE: Jan. 15, 2022			

CUSTOMER APPROVE	
DATE:	

1/16/2022

SMD SCHOTTKY BARRIER RECTIFIER TO-277 SERIES



MAIN FEATURE

- Plastic Material - UL Flammability Classification 94V-0
- Schottky Barrier Chip
- High Thermal Reliability
- Patented Super Barrier Rectifier Technology
- High Forward Surge Current Capability
- High Temperature Soldering
- Ultra Power Loss, High Efficiency

APPLICATION

- For surface mounted applications

RFQ

[Request For Quotation](#)

PART CODE GUIDE

TO277	SL1045	S	45
1	2	3	4

- 1) **TO277**: SMD Schottky Barrier Rectifier, Package TO-277 series
- 2) **SL1045**: Specification code for original part number SL1045 type, Forward Current 10A Max.
- 3) **S**: Package code, Tape/Reel, 5000pcs/reel.
- 4) **45**: Specification code for Reverse Voltage 45V Max.

SMD SCHOTTKY BARRIER RECTIFIER TO-277 SERIES

DIMENSION (Unit: Inch/mm)

Image for reference



Marking: SL1045

TO-277

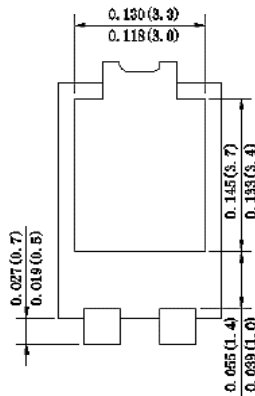
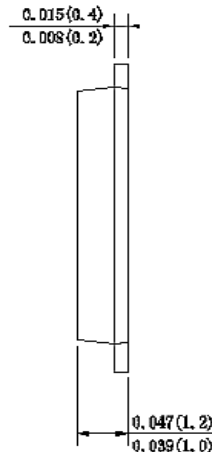
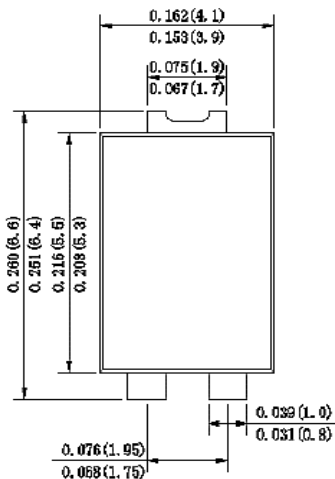

Recommend Pad Layout

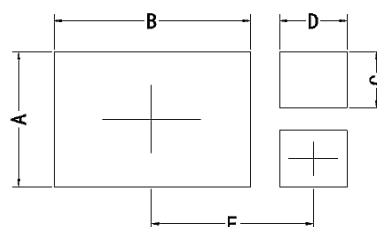

Symbol	Unit (inch)	Unit (mm)
A	0.142	3.60
B	0.211	5.35
C	0.059	1.50
D	0.073	1.85
E	0.169	4.30

SMD SCHOTTKY BARRIER RECTIFIER TO-277 SERIES
MECHANICAL DATA

Case	Terminals	Polarity	Mounting Position	Weight per piece
JEDEC TO-277 molded plastic body	Plated Leads Solderable per MIL-STD-202 Method 208	Polarity symbol marking on case	Any	0.003 Ounce, 0.092 grams

MAX. RATING & CHARACTERISTICS

Parameter	SYMBOLS	VALUE			UNITS
		Min.	Typical	Max.	
Repetitive Peak Reverse Voltage	V _{RRM}			45	Volts
RMS Voltage	V _{RMS}			32	Volts
DC Blocking Voltage	V _{DC}			45	Volts
Average Rectified Output Current	I _(O)			10	A
Non- Repetitive Peak Forward Surge Current 8.3ms Single Half Sine-wave Superimposed On Rated Load (JEDEC Method)	I _{FSM}		250		A
Forward Voltage Drop At 10A	V _F			0.45	Volts
Peak Reverse Current At Rated DC Blocking Voltage	I _R			0.3	mA
				15	mA
Thermal Resistance	R _{QJA}		80		°C/W
Junction To Ambient	R _{QJL}		15		°C/W
Operating Junction Temperature Range	T _J	-55		+150	°C
Storage Temperature Range	T _{STG}	-55		+150	°C

Note

1. Ratings at 25 C ambient temperature unless otherwise specified. Single phase half-wave 60Hz, resistive or inductive load, for capacitive load current derate by 20%.
2. Valid provided that are kept at ambient temperature at a distance of 9.5mm from the case
3. Fr-4pcs. 2 oz. copper, Min. recommend pad layout. 18.8*14.4mm, Anode pad dimensions 5.6*14.4mm.

SMD SCHOTTKY BARRIER RECTIFIER TO-277 SERIES
RELIABILITY

Number	Experiment Items	Experiment Method And Conditions	Reference Documents
1	Solder Resistance Test	Test 250°C± 5°C for 10 ± 2 sec. Immerse body into solder 1/16" ± 1/32"	MIL-STD-750D METHOD-2031.2
2	Solderability Test	230°C ±5°C for 5 sec.	MIL-STD-750D METHOD-2026.1 0
3	Pull Test	1 kg in axial lead direction for 10 sec.	MIL-STD-750D METHOD-2036.4
4	Bend Test	0.5Kg Weight Applied To Each Lead, Bending Arcs 90 °C ± 5 °C For 3 Times	MIL-STD-750D METHOD-2036.4
5	High Temperature Reverse Bias Test	TA=100°C for 1000 Hours at VR=80% Rated VR	MIL-STD-750D METHOD-1038.4
6	Forward Operation Life Test	TA=25°C Rated Average Rectified Current	MIL-STD-750D METHOD-1027.3
7	Intermittent Operation Life Test	On state: 5 min with rated IRMS Power Off state: 5 min with Cool Forced Air. On and off for 1000 cycles.	MIL-STD-750D METHOD-1036.3
8	Pressure Cooker Test	15 PSIG, TA=121°C, 4 hours	MIL-S-19500 APPENOIXC
9	Temperature Cycling Test	-55°C~+125°C; 30 Minutes For Dwelled Time 5 minutes for transferred time. Total: 10 cycles.	MIL-STD-750D METHOD-1051.7
10	Thermal Shock Test	0°C for 5 minutes., 100°C for 5minutes, Total: 10 cycles	MIL-STD-750D METHOD-1056.7
11	Forward Surge Test	8.3ms Single Sale Sine-wave One Surge.	MIL-STD-750D METHOD-4066.4
12	Humidity Test	TA=65°C, RH=98% for 1000 hours.	MIL-STD-750D METHOD-1021.3
13	High Temperature Storage life Test	150°C for 1000 Hours	MIL-STD-750D METHOD-1031.5

SMD SCHOTTKY BARRIER RECTIFIER TO-277 SERIES

SUGGESTED REFLOW PROFILE (For Reference Only)

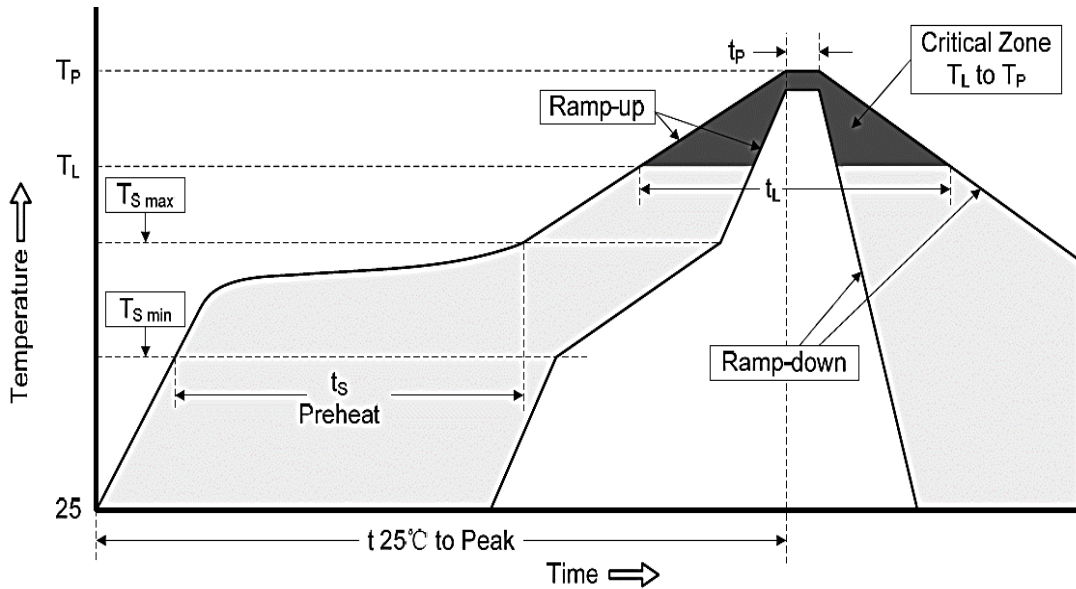

Profile Feature		Pb-Free Assembly
Average Ramp-up Rate (Ts Max to Tp)		3°C/second Max
Preheat	Temperature Min (Ts Min.)	150°C
	Temperature Max (Ts Max.)	200°C
	Time (ts Min. to ts Max.)	60 ~ 180 seconds
Time maintained above	Temperature (Tl)	217°C
	Time (tl)	60 ~ 150 seconds
Peak/Classification Temperature (Tp)		260 °C
Time within 5°C of actual Peak Temperature (tp)		10 seconds
Ramp-down rate		6 °C /Second Max.
Time 25 °C to Peak Temperature		6 minutes Max.
Suggest reflow times		3 Times Max.

SMD SCHOTTKY BARRIER RECTIFIER TO-277 SERIES

RATINGS AND CHARACTERISTIC CURVES (For Reference Only)

Fig.1 - Forward Current Derating Curve

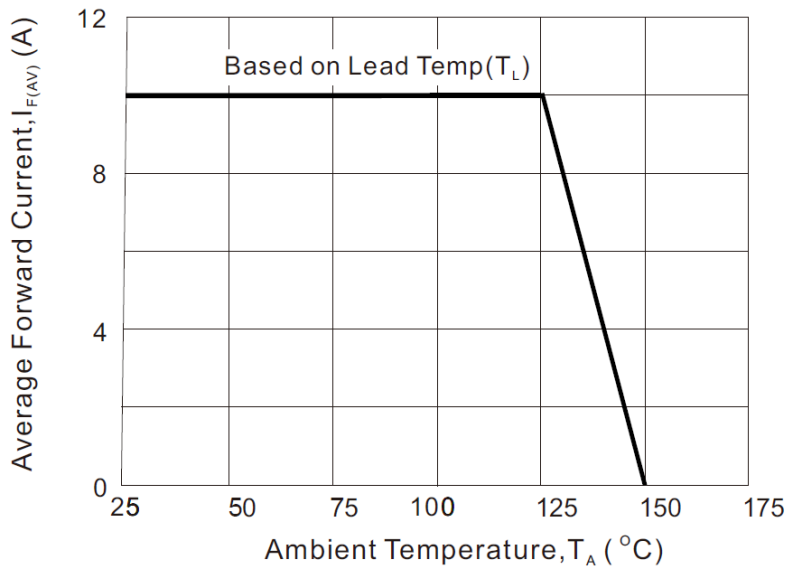
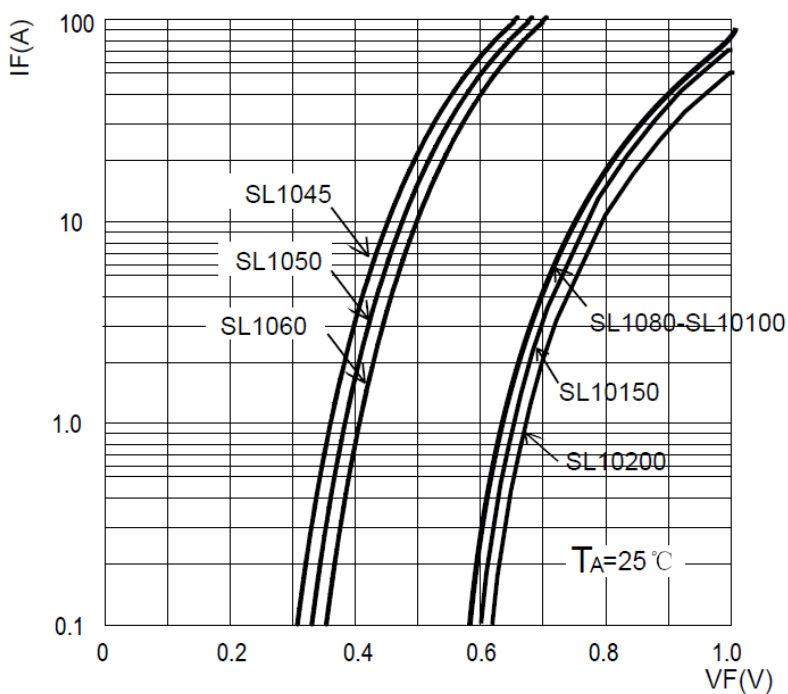

Fig2 : Instantaneous Forward Voltage



SMD SCHOTTKY BARRIER RECTIFIER TO-277 SERIES

RATINGS AND CHARACTERISTIC CURVES (For Reference Only)

Fig3: Surge Forward Current Capability

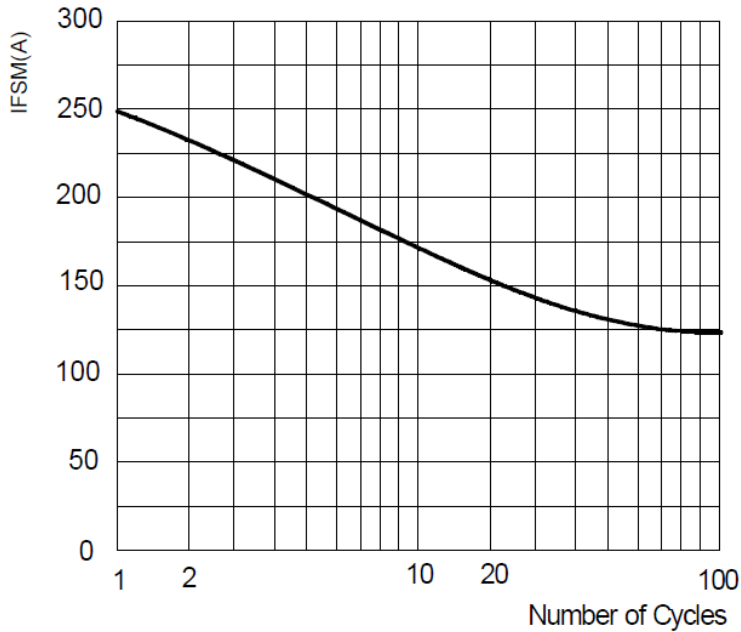
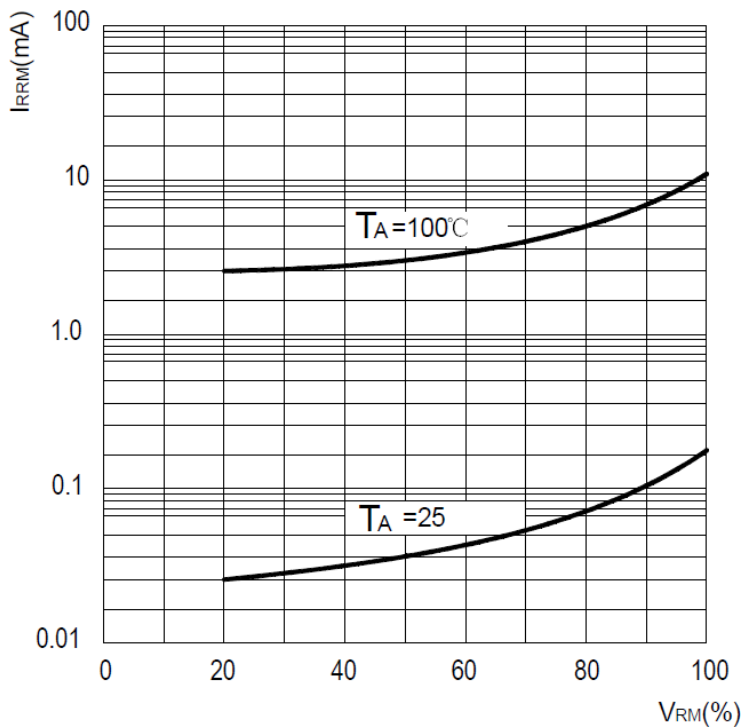

Fig4: Typical Reverse Characteristics



SMD SCHOTTKY BARRIER RECTIFIER TO-277 SERIES

TAPE/REEL (Unit: mm)

All Devices are packed in accordance with EIA standard RS-481-A and specifications.

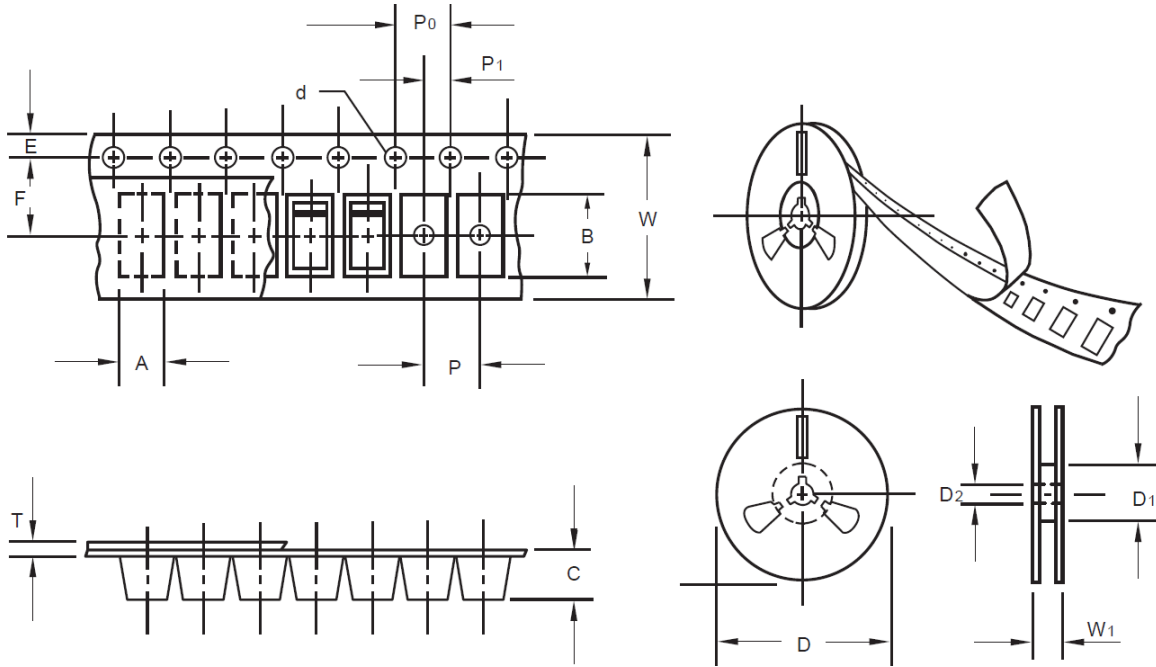

Item	Symbol	Tolerance	TO-277
Carrier width	A	0.1	4.45
Carrier Length	B	0.1	7.0
Carrier Depth	C	0.1	1.60
Sprocket hole	d	0.05	1.55
13" Reel outside diameter	D	2.0	330.00
13" Reel inner diameter	D1	Min.	50.00
7" Reel outside diameter	-	-	-
7" Reel inner diameter	-	-	-
Feed hole diameter	D2	0.5	13.00
Sprocket hole position	E	0.1	1.75
Punch hole position	F	0.1	7.50
Punch hole pitch	P	0.1	8.00
Sprocket hole pitch	P0	0.1	4.00
Embossment center	P1	0.1	2.00
Overall tape thickness	T	0.1	0.25
Tape width	W	0.3	12.00
Reel width	W1	1.0	12.30

SMD SCHOTTKY BARRIER RECTIFIER TO-277 SERIES

PACKAGE For Reference

Case Code	TO-277
Reel Size	13"
Reel Size	330 mm
MPQ/Reel	5000 pcs
Qty. /Box	10000 pcs
G.W/Box	6 lbs

DISCLAIMER

NextGen Component, Inc. reserves the right to make changes to the product(s) and or information contained herein without notice. No liability is assumed as a result of their use or application. No rights under any patent accompany the sale of any such product(s) or information







Looking for pricing, stock, or lifecycle information?

Click below to explore more details on WIN SOURCE:

 [View SL1045 on WIN SOURCE](#)

 [MDD Information](#)

Optimize Your Supply Chain with WIN SOURCE Solutions

-  Global Sourcing Solution
-  Obsolete Management
-  Cost Control Management
-  Shortage Management
-  Alternative Solution
-  Excess Inventory Management