



**THE DATASHEET OF
ADR366WAUJZ-REEL7**





Low Power, Low Noise Voltage References with Sink/Source Capability

Data Sheet

ADR360/ADR361/ADR363/ADR364/ADR365/ADR366

FEATURES

Compact TSOT package

Low temperature coefficient

A grade: 25 ppm/°C

B grade: 9 ppm/°C

H grade: 25 ppm/°C

Initial accuracy

A grade: ±6 mV maximum (ADR360, ADR361, and ADR363)

B grade: ±3 mV maximum (ADR360, ADR361, and ADR363)

Ultralow output voltage noise: 6.8 μV p-p (0.1 Hz to 10 Hz)

Low dropout: 300 mV

Low quiescent current: 190 μA maximum

No external capacitor required

Output current: +5 mA (sourcing), –1 mA (sinking)

Wide temperature range

–40°C to +125°C (A grade, B grade)

–40°C to +150°C (H grade)

Qualified for automotive applications

–40°C to +150°C

ADR365WHUJZ-R7

–40°C to +125°C

ADR365WAUJZ-R7, ADR366WAUJZ-REEL7

APPLICATIONS

Battery-powered instruments

Portable medical instruments

Data acquisition systems

Industrial process controls

Automotive

GENERAL DESCRIPTION

The ADR360/ADR361/ADR363/ADR364/ADR365/ADR366 are precision 2.048 V, 2.500 V, 3.000 V, 4.096 V, 5.000 V, and 3.300 V band gap voltage references that offer low power and high precision in a compact TSOT package. Using proprietary temperature drift curvature correction techniques from Analog Devices, Inc., the ADR360/ADR361/ADR363/ADR364/ADR365/ADR366 references achieve a low temperature drift of 9 ppm/°C in a TSOT package.

The ADR360/ADR361/ADR363/ADR364/ADR365/ADR366 family of micropower, low dropout voltage references provide a

PIN CONFIGURATION

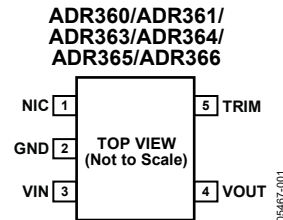

Figure 1. 5-Lead TSOT (UJ-5)

Table 1. ADR360/ADR361/ADR363/ADR364/ADR365/ADR366 Family of Devices

Model	V _{OUT} (V) ¹	Temperature Coefficient (ppm/°C)	Accuracy (mV)
ADR360B	2.048	9	±3
ADR360A	2.048	25	±6
ADR361B	2.500	9	±3
ADR361A	2.500	25	±6
ADR363B	3.000	9	±3
ADR363A	3.000	25	±6
ADR364B	4.096	9	±4
ADR364A	4.096	25	±8
ADR365B	5.000	9	±4
ADR365A	5.000	25	±8
ADR365H	5.000	25	±8
ADR366B	3.300	9	±4
ADR366A	3.300	25	±8

¹ Contact Analog Devices, Inc., for other voltage options.

stable output voltage from a minimum supply of 300 mV greater than the output. The advanced design of the devices eliminates the need for external capacitors, which further reduces board space and system cost. The combination of low power operation, small size, and ease of use makes the ADR360/ADR361/ADR363/ADR364/ADR365/ADR366 precision voltage references ideally suited for battery-operated applications.

See the Ordering Guide for automotive grades.

Rev. E

[Document Feedback](#)

Information furnished by Analog Devices is believed to be accurate and reliable. However, no responsibility is assumed by Analog Devices for its use, nor for any infringements of patents or other rights of third parties that may result from its use. Specifications subject to change without notice. No license is granted by implication or otherwise under any patent or patent rights of Analog Devices. Trademarks and registered trademarks are the property of their respective owners.

One Technology Way, P.O. Box 9106, Norwood, MA 02062-9106, U.S.A.
 Tel: 781.329.4700 ©2005–2019 Analog Devices, Inc. All rights reserved.
 Technical Support www.analog.com

TABLE OF CONTENTS

Features 1
 Applications 1
 Pin Configuration 1
 General Description 1
 Revision History 2
 Specifications 3
 ADR360 Electrical Characteristics 3
 ADR361 Electrical Characteristics 4
 ADR363 Electrical Characteristics 5
 ADR364 Electrical Characteristics 6
 ADR365 Electrical Characteristics 7
 ADR366 Electrical Characteristics 8
 Absolute Maximum Ratings 9
 Thermal Resistance 9

ESD Caution 9
 Pin Configuration and Function Descriptions 10
 Typical Performance Characteristics 11
 Terminology 17
 Theory of Operation 18
 Device Power Dissipation Considerations 18
 Input Capacitor 18
 Output Capacitor 18
 Applications Information 19
 Basic Voltage Reference Connection 19
 Outline Dimensions 20
 Ordering Guide 20
 Automotive Products 20

REVISION HISTORY

3/2019—Rev. D to Rev. E

Changes to Features Section, Figure 1, Table 1, and General Description Section 1
 Changes to Table 2 3
 Changes to Table 3 4
 Changes to Table 4 5
 Changes to Table 5 6
 Changes to Table 6 7
 Changes to Table 7 8
 Changes to Thermal Resistance Section and Table 9 9
 Added Pin Configuration and Function Descriptions Section, Figure 2, and Table 10; Renumbered Sequentially 10
 Added Figure 7 11
 Changes to Figure 9 12
 Added Figure 12 12
 Added Figure 16 13
 Changes to Figure 18 13
 Deleted Negative Precision Reference Without Precision Resistors Section and Figure 35 17
 Changes to Theory of Operation Section, Device Power Dissipation Considerations Section, Input Capacitor Section, Output Capacitor Section, and Figure 36 18
 Changes to Applications Information Section, Figure 37 to Figure 40, Stacking Reference ICs for Arbitrary Outputs Section, General-Purpose Current Source Section, and Trim Terminal Section 19
 Updated Outline Dimensions 20
 Changes to Ordering Guide 20

Changed Supply Voltage Headroom to Dropout Voltage Throughout 3
 Changed 0.1 Hz to 10 Hz to $f = 0.1$ Hz to 10 Hz Throughout 3
 Change to Table 8 9
 Changes to Figure 13 11
 Changes to Figure 14 12
 Changes to Ordering Guide 20
 Added Automotive Products Section 20

7/07—Rev. B to Rev. C

Changes to Ripple Rejection Ratio in Table 2 3
 Changes to Ripple Rejection Ratio in Table 3 4
 Changes to Ripple Rejection Ratio in Table 4 5
 Changes to Ripple Rejection Ratio in Table 5 6
 Changes to Ripple Rejection Ratio in Table 6 7
 Changes to Ripple Rejection Ratio in Table 7 8

2/07—Rev. A to Rev. B

Changes to Table 7 8
 Changes to Figure 6 11
 Changes to Figure 13, Figure 14, Figure 17, and Figure 27 Captions 12
 Changes to Ordering Guide 19

3/06—Rev. 0 to Rev. A

Changes to Figure 15 Caption 13
 Changes to Figure 21 Caption 14
 Changes to Theory of Operation Section 16
 Changes to Figure 36 18

4/05—Revision 0: Initial Version

10/10—Rev. C to Rev. D

Changes to Features Section and General Description Section . 1

SPECIFICATIONS

ADR360 ELECTRICAL CHARACTERISTICS

Input voltage (V_{IN}) = 2.35 V to 15 V, $T_A = 25^\circ\text{C}$, unless otherwise noted.

Table 2.

Parameter	Symbol	Test Conditions/Comments	Min	Typ	Max	Unit
OUTPUT VOLTAGE	V_{OUT}	A grade	2.042	2.048	2.054	V
		B grade	2.045	2.048	2.051	V
INITIAL ACCURACY	V_{OUTERR}	A grade			± 6	mV
		A grade			± 0.29	%
		B grade			± 3	mV
		B grade			± 0.15	%
TEMPERATURE COEFFICIENT	TCV_{OUT}	A grade, $-40^\circ\text{C} < T_A < +125^\circ\text{C}$			25	ppm/ $^\circ\text{C}$
		B grade, $-40^\circ\text{C} < T_A < +125^\circ\text{C}$			9	ppm/ $^\circ\text{C}$
DROPOUT VOLTAGE	$V_{IN} - V_{OUT}$		300			mV
LINE REGULATION	$\Delta V_{OUT}/\Delta V_{IN}$	$V_{IN} = 2.45\text{ V to } 15\text{ V}$, $-40^\circ\text{C} < T_A < +125^\circ\text{C}$			0.105	mV/V
LOAD REGULATION	$\Delta V_{OUT}/\Delta I_{LOAD}$	Load resistance (I_{LOAD}) = 0 mA to 5 mA, $-40^\circ\text{C} < T_A < +125^\circ\text{C}$, $V_{IN} = 3\text{ V}$			0.37	mV/mA
		$I_{LOAD} = -1\text{ mA to } 0\text{ mA}$, $-40^\circ\text{C} < T_A < +125^\circ\text{C}$, $V_{IN} = 3\text{ V}$			0.82	mV/mA
QUIESCENT CURRENT	I_{IN}	$-40^\circ\text{C} < T_A < +125^\circ\text{C}$		150	190	μA
OUTPUT CURRENT	I_{OUT}		5			mA
			-1			mA
VOLTAGE NOISE	$e_{N\text{ p-p}}$	Frequency = 0.1 Hz to 10 Hz		6.8		$\mu\text{V p-p}$
TURN ON SETTLING TIME	t_R			25		μs
LONG-TERM STABILITY ¹	ΔV_{OUT}	1000 hours		50		ppm
OUTPUT VOLTAGE HYSTERESIS	ΔV_{OUT_HYS}			100		ppm
RIPPLE REJECTION RATIO	RRR	Input frequency (f_{IN}) = 60 Hz		-70		dB
SHORT-CIRCUIT TO GND	I_{SC}	$V_{IN} = 5\text{ V}$		25		mA
		$V_{IN} = 15\text{ V}$		30		mA

¹ The long-term stability specification is noncumulative. The drift after the first 1000 hours is significantly lower than the drift is in the first 1000 hours.

ADR361 ELECTRICAL CHARACTERISTICS

$V_{IN} = 2.8 \text{ V to } 15 \text{ V}$, $T_A = 25^\circ\text{C}$, unless otherwise noted.

Table 3.

Parameter	Symbol	Test Conditions/Comments	Min	Typ	Max	Unit
OUTPUT VOLTAGE	V_{OUT}	A grade	2.494	2.500	2.506	V
		B grade	2.497	2.500	2.503	V
INITIAL ACCURACY	V_{OUTERR}	A grade			±6	mV
		A grade			±0.24	%
		B grade			±3	mV
		B grade			±0.12	%
TEMPERATURE COEFFICIENT	TCV_{OUT}	A grade, $-40^\circ\text{C} < T_A < +125^\circ\text{C}$			25	ppm/°C
		B grade, $-40^\circ\text{C} < T_A < +125^\circ\text{C}$			9	ppm/°C
DROPOUT VOLTAGE	$V_{IN} - V_{OUT}$		300			mV
LINE REGULATION	$\Delta V_{OUT}/\Delta V_{IN}$	$V_{IN} = 2.8 \text{ V to } 15 \text{ V}$, $-40^\circ\text{C} < T_A < +125^\circ\text{C}$			0.125	mV/V
LOAD REGULATION	$\Delta V_{OUT}/\Delta I_{LOAD}$	$I_{LOAD} = 0 \text{ mA to } 5 \text{ mA}$, $-40^\circ\text{C} < T_A < +125^\circ\text{C}$, $V_{IN} = 3.5 \text{ V}$			0.45	mV/mA
		$I_{LOAD} = -1 \text{ mA to } 0 \text{ mA}$, $-40^\circ\text{C} < T_A < +125^\circ\text{C}$, $V_{IN} = 3.5 \text{ V}$			1	mV/mA
QUIESCENT CURRENT	I_{IN}	$-40^\circ\text{C} < T_A < +125^\circ\text{C}$		150	190	µA
OUTPUT CURRENT	I_{OUT}		5			mA
			-1			mA
VOLTAGE NOISE	$e_{N \text{ p-p}}$	Frequency = 0.1 Hz to 10 Hz		8.25		µV p-p
TURN ON SETTLING TIME	t_R			25		µs
LONG-TERM STABILITY ¹	ΔV_{OUT}	1000 hours		50		ppm
OUTPUT VOLTAGE HYSTERESIS	ΔV_{OUT_HYS}			100		ppm
RIPPLE REJECTION RATIO	RRR	$f_{IN} = 60 \text{ Hz}$		-70		dB
SHORT-CIRCUIT TO GND	I_{SC}	$V_{IN} = 5 \text{ V}$		25		mA
		$V_{IN} = 15 \text{ V}$		30		mA

¹ The long-term stability specification is noncumulative. The drift after the first 1000 hours is significantly lower than the drift is in the first 1000 hours.

ADR363 ELECTRICAL CHARACTERISTICS

$V_{IN} = 3.3\text{ V to }15\text{ V}$, $T_A = 25^\circ\text{C}$, unless otherwise noted.

Table 4.

Parameter	Symbol	Test Conditions/Comments	Min	Typ	Max	Unit
OUTPUT VOLTAGE	V_{OUT}	A grade	2.994	3.000	3.006	V
		B grade	2.997	3.000	3.003	V
INITIAL ACCURACY	V_{OUTERR}	A grade			±6	mV
		A grade			±0.2	%
		B grade			±3	mV
		B grade			±0.1	%
TEMPERATURE COEFFICIENT	TCV_{OUT}	A grade, $-40^\circ\text{C} < T_A < +125^\circ\text{C}$			25	ppm/°C
		B grade, $-40^\circ\text{C} < T_A < +125^\circ\text{C}$			9	ppm/°C
DROPOUT VOLTAGE	$V_{IN} - V_{OUT}$		300			mV
LINE REGULATION	$\Delta V_{OUT}/\Delta V_{IN}$	$V_{IN} = 3.3\text{ V to }15\text{ V}$, $-40^\circ\text{C} < T_A < +125^\circ\text{C}$			0.15	mV/V
LOAD REGULATION	$\Delta V_{OUT}/\Delta I_{LOAD}$	$I_{LOAD} = 0\text{ mA to }5\text{ mA}$, $-40^\circ\text{C} < T_A < +125^\circ\text{C}$, $V_{IN} = 4\text{ V}$			0.54	mV/mA
		$I_{LOAD} = -1\text{ mA to }0\text{ mA}$, $-40^\circ\text{C} < T_A < +125^\circ\text{C}$, $V_{IN} = 4\text{ V}$			1.2	mV/mA
QUIESCENT CURRENT	I_{IN}	$-40^\circ\text{C} < T_A < +125^\circ\text{C}$		150	190	µA
OUTPUT CURRENT	I_{OUT}		5			mA
			-1			mA
VOLTAGE NOISE	$e_{N\text{ p-p}}$	Frequency = 0.1 Hz to 10 Hz		8.7		µV p-p
TURN ON SETTLING TIME	t_R			25		µs
LONG-TERM STABILITY ¹	ΔV_{OUT}	1000 hours		50		ppm
OUTPUT VOLTAGE HYSTERESIS	ΔV_{OUT_HYS}			100		ppm
RIPPLE REJECTION RATIO	RRR	$f_{IN} = 60\text{ Hz}$		-70		dB
SHORT-CIRCUIT TO GND	I_{SC}	$V_{IN} = 5\text{ V}$		25		mA
		$V_{IN} = 15\text{ V}$		30		mA

¹ The long-term stability specification is noncumulative. The drift after the first 1000 hours is significantly lower than the drift is in the first 1000 hours.

ADR364 ELECTRICAL CHARACTERISTICS

$V_{IN} = 4.4 \text{ V to } 15 \text{ V}$, $T_A = 25^\circ\text{C}$, unless otherwise noted.

Table 5.

Parameter	Symbol	Test Conditions/Comments	Min	Typ	Max	Unit
OUTPUT VOLTAGE	V_{OUT}	A grade	4.088	4.096	4.104	V
		B grade	4.092	4.096	4.100	V
INITIAL ACCURACY	V_{OUTERR}	A grade			±8	mV
		A grade			±0.2	%
		B grade			±4	mV
		B grade			±0.1	%
TEMPERATURE COEFFICIENT	TCV_{OUT}	A grade, $-40^\circ\text{C} < T_A < +125^\circ\text{C}$			25	ppm/°C
		B grade, $-40^\circ\text{C} < T_A < +125^\circ\text{C}$			9	ppm/°C
DROPOUT VOLTAGE	$V_{IN} - V_{OUT}$		300			mV
LINE REGULATION	$\Delta V_{OUT}/\Delta V_{IN}$	$V_{IN} = 4.4 \text{ V to } 15 \text{ V}$, $-40^\circ\text{C} < T_A < +125^\circ\text{C}$			0.205	mV/V
LOAD REGULATION	$\Delta V_{OUT}/\Delta I_{LOAD}$	$I_{LOAD} = 0 \text{ mA to } 5 \text{ mA}$, $-40^\circ\text{C} < T_A < +125^\circ\text{C}$, $V_{IN} = 5 \text{ V}$			0.735	mV/mA
		$I_{LOAD} = -1 \text{ mA to } 0 \text{ mA}$, $-40^\circ\text{C} < T_A < +125^\circ\text{C}$, $V_{IN} = 5 \text{ V}$			1.75	mV/mA
QUIESCENT CURRENT	I_{IN}	$-40^\circ\text{C} < T_A < +125^\circ\text{C}$		150	190	μA
OUTPUT CURRENT	I_{OUT}		5			mA
			-1			mA
VOLTAGE NOISE	$e_{N\text{ p-p}}$	Frequency = 0.1 Hz to 10 Hz		11		μV p-p
TURN ON SETTLING TIME	t_R			25		μs
LONG-TERM STABILITY ¹	ΔV_{OUT}	1000 hours		50		ppm
OUTPUT VOLTAGE HYSTERESIS	ΔV_{OUT_HYS}			100		ppm
RIPPLE REJECTION RATIO	RRR	$f_{IN} = 60 \text{ Hz}$		-70		dB
SHORT-CIRCUIT TO GND	I_{SC}	$V_{IN} = 5 \text{ V}$		25		mA
		$V_{IN} = 15 \text{ V}$		30		mA

¹ The long-term stability specification is noncumulative. The drift after the first 1000 hours is significantly lower than the drift is in the first 1000 hours.

ADR365 ELECTRICAL CHARACTERISTICS

$V_{IN} = 5.3 \text{ V to } 15 \text{ V}$, $T_A = 25^\circ\text{C}$, unless otherwise noted.

Table 6.

Parameter	Symbol	Test Conditions/Comments	Min	Typ	Max	Unit
OUTPUT VOLTAGE	V_{OUT}	A grade	4.992	5.000	5.008	V
		B grade	4.996	5.000	5.004	V
		H grade	4.992	5.000	5.008	V
INITIAL ACCURACY	V_{OUTERR}	A grade			± 8	mV
		A grade			± 0.16	%
		B grade			± 4	mV
		B grade			± 0.08	%
		H grade			± 8	mV
		H grade			± 0.16	%
TEMPERATURE COEFFICIENT	TCV_{OUT}	A grade, $-40^\circ\text{C} < T_A < +125^\circ\text{C}$			25	ppm/ $^\circ\text{C}$
		B grade, $-40^\circ\text{C} < T_A < +125^\circ\text{C}$			9	ppm/ $^\circ\text{C}$
		H grade, $-40^\circ\text{C} < T_A < +150^\circ\text{C}$			25	ppm/ $^\circ\text{C}$
DROPOUT VOLTAGE	$V_{IN} - V_{OUT}$		300			mV
LINE REGULATION	$\Delta V_{OUT}/\Delta V_{IN}$	$V_{IN} = 5.3 \text{ V to } 15 \text{ V}$, $-40^\circ\text{C} < T_A < +125^\circ\text{C}$			0.25	mV/V
		$V_{IN} = 5.3 \text{ V to } 15 \text{ V}$, $-40^\circ\text{C} < T_A < +150^\circ\text{C}$ (H grade only)			1.8	mV/V
LOAD REGULATION	$\Delta V_{OUT}/\Delta I_{LOAD}$	$I_{LOAD} = 0 \text{ mA to } 5 \text{ mA}$, $-40^\circ\text{C} < T_A < +125^\circ\text{C}$, $V_{IN} = 6 \text{ V}$			0.9	mV/mA
		$I_{LOAD} = -1 \text{ mA to } 0 \text{ mA}$, $-40^\circ\text{C} < T_A < +125^\circ\text{C}$, $V_{IN} = 6 \text{ V}$			2	mV/mA
		$I_{LOAD} = 0 \text{ mA to } 5 \text{ mA}$, $-40^\circ\text{C} < T_A < +125^\circ\text{C}$, $V_{IN} = 6 \text{ V}$ (H grade only)			3.6	mV/mA
		$I_{LOAD} = -1 \text{ mA to } 0 \text{ mA}$, $-40^\circ\text{C} < T_A < +125^\circ\text{C}$, $V_{IN} = 6 \text{ V}$ (H grade only)			30	mV/mA
QUIESCENT CURRENT	I_{IN}	$-40^\circ\text{C} < T_A < +125^\circ\text{C}$		150	190	μA
		$-40^\circ\text{C} < T_A < +150^\circ\text{C}$ (H grade only)		150	190	μA
OUTPUT CURRENT	I_{OUT}	Sourcing	5			mA
		Sinking	-1			mA
VOLTAGE NOISE	$e_{N \text{ p-p}}$	Frequency = 0.1 Hz to 10 Hz		12.8		$\mu\text{V p-p}$
TURN ON SETTLING TIME	t_R			20		μs
LONG-TERM STABILITY ¹	ΔV_{OUT}	1000 hours		50		ppm
OUTPUT VOLTAGE HYSTERESIS	ΔV_{OUT_HYS}			100		ppm
RIPPLE REJECTION RATIO	RRR	$f_{IN} = 60 \text{ Hz}$		-70		dB
SHORT-CIRCUIT TO GND	I_{SC}	$V_{IN} = 5 \text{ V}$		25		mA
		$V_{IN} = 15 \text{ V}$		30		mA

¹ The long-term stability specification is noncumulative. The drift after the first 1000 hours is significantly lower than the drift is in the first 1000 hours.

ADR366 ELECTRICAL CHARACTERISTICS

$V_{IN} = 3.6\text{ V to }15\text{ V}$, $T_A = 25^\circ\text{C}$, unless otherwise noted.

Table 7.

Parameter	Symbol	Test Conditions/Comments	Min	Typ	Max	Unit
OUTPUT VOLTAGE	V_{OUT}	A grade	3.292	3.300	3.308	V
		B grade	3.296	3.300	3.304	V
INITIAL ACCURACY	V_{OUTERR}	A grade			±8	mV
		A grade			±0.25	%
		B grade			±4	mV
		B grade			±0.125	%
TEMPERATURE COEFFICIENT	TCV_{OUT}	A grade, $-40^\circ\text{C} < T_A < +125^\circ\text{C}$			25	ppm/°C
		B grade, $-40^\circ\text{C} < T_A < +125^\circ\text{C}$			9	ppm/°C
DROPOUT VOLTAGE	$V_{IN} - V_{OUT}$		300			mV
LINE REGULATION	$\Delta V_{OUT}/\Delta V_{IN}$	$V_{IN} = 3.6\text{ V to }15\text{ V}$, $-40^\circ\text{C} < T_A < +125^\circ\text{C}$			0.165	mV/V
LOAD REGULATION	$\Delta V_{OUT}/\Delta I_{LOAD}$	$I_{LOAD} = 0\text{ mA to }5\text{ mA}$, $-40^\circ\text{C} < T_A < +125^\circ\text{C}$, $V_{IN} = 4.2\text{ V}$			0.6	mV/mA
		$I_{LOAD} = 0\text{ mA to }8\text{ mA}$, $-40^\circ\text{C} < T_A < +125^\circ\text{C}$, $V_{IN} \geq 4.75\text{ V}$			0.6	mV/mA
		$I_{LOAD} = -1\text{ mA to }0\text{ mA}$, $-40^\circ\text{C} < T_A < +125^\circ\text{C}$, $V_{IN} = 4.2\text{ V}$			1.35	mV/mA
QUIESCENT CURRENT	I_{IN}	$-40^\circ\text{C} < T_A < +125^\circ\text{C}$		150	190	µA
OUTPUT CURRENT	I_{OUT}		5			mA
			-1			mA
VOLTAGE NOISE	$e_{N\text{ p-p}}$	Frequency = 0.1 Hz to 10 Hz		9.3		µV p-p
TURN ON SETTLING TIME	t_R			25		µs
LONG-TERM STABILITY ¹	ΔV_{OUT}	1000 hours		50		ppm
OUTPUT VOLTAGE HYSTERESIS	ΔV_{OUT_HYS}			100		ppm
RIPPLE REJECTION RATIO	RRR	$f_{IN} = 60\text{ Hz}$		-70		dB
SHORT-CIRCUIT TO GND	I_{SC}	$V_{IN} = 5\text{ V}$		25		mA
		$V_{IN} = 15\text{ V}$		30		mA

¹ The long-term stability specification is noncumulative. The drift after the first 1000 hours is significantly lower than the drift is in the first 1000 hours.

ABSOLUTE MAXIMUM RATINGS

$T_A = 25^\circ\text{C}$, unless otherwise noted.

Table 8.

Parameter	Rating
Supply Voltage	18 V
Output Short-Circuit Duration to GND	
$V_{IN} < 15\text{ V}$	Indefinite
$V_{IN} > 15\text{ V}$	10 sec
Storage Temperature Range	-65°C to $+125^\circ\text{C}$
Operating Temperature Range	-40°C to $+125^\circ\text{C}$
Junction Temperature Range	-65°C to $+150^\circ\text{C}$
Lead Temperature (Soldering, 60 sec)	300°C

Stresses at or above those listed under Absolute Maximum Ratings may cause permanent damage to the product. This is a stress rating only; functional operation of the product at these or any other conditions above those indicated in the operational section of this specification is not implied. Operation beyond the maximum operating conditions for extended periods may affect product reliability.

THERMAL RESISTANCE

Thermal performance is directly linked to printed circuit board (PCB) design and operating environment. Careful attention to PCB thermal design is required.

θ_{JA} is the natural convection, junction to ambient thermal resistance measured in a one cubic foot sealed enclosure.

θ_{JC} is the junction to case thermal resistance.

Table 9. Thermal Resistance

Package Type	θ_{JA}	θ_{JC}	Unit
UJ-5	230	146	$^\circ\text{C}/\text{W}$

ESD CAUTION



ESD (electrostatic discharge) sensitive device. Charged devices and circuit boards can discharge without detection. Although this product features patented or proprietary protection circuitry, damage may occur on devices subjected to high energy ESD. Therefore, proper ESD precautions should be taken to avoid performance degradation or loss of functionality.

PIN CONFIGURATION AND FUNCTION DESCRIPTIONS



NOTES
1. NIC = NOT INTERNALLY CONNECTED.
THIS PIN IS NOT CONNECTED INTERNALLY.

05467-040

Figure 2. Pin Configuration

Table 10. Pin Function Descriptions

Pin No.	Mnemonic	Description
1	NIC	Not Internally Connected. This pin is not connected internally.
2	GND	Ground.
3	VIN	Input Voltage Connection.
4	VOUT	Output Voltage.
5	TRIM	Output Voltage Trim.

TYPICAL PERFORMANCE CHARACTERISTICS



Figure 3. ADR360 V_{OUT} vs. Temperature

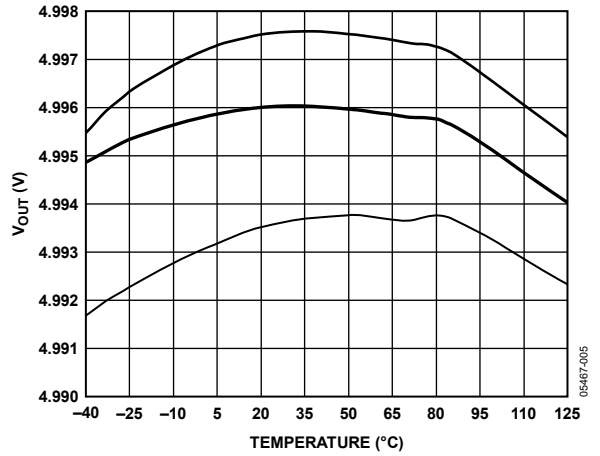

Figure 6. ADR365 V_{OUT} vs. Temperature



Figure 4. ADR361 V_{OUT} vs. Temperature

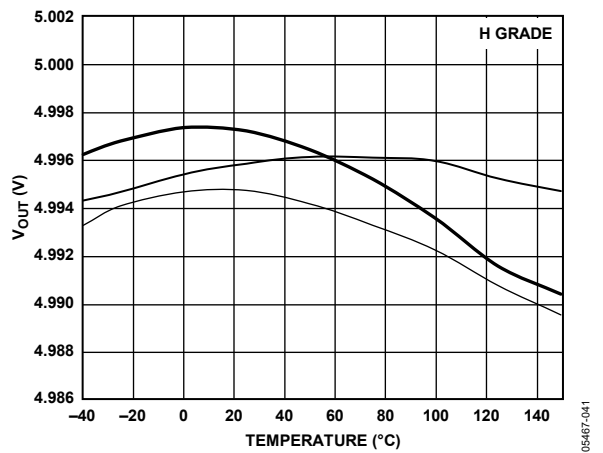

Figure 7. ADR365 H Grade V_{OUT} vs. Temperature

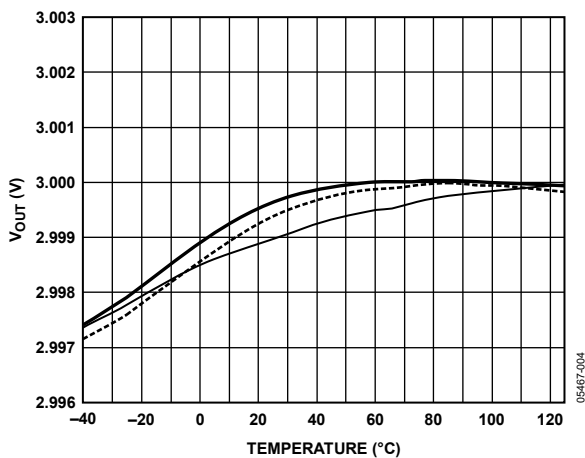

Figure 5. ADR363 V_{OUT} vs. Temperature

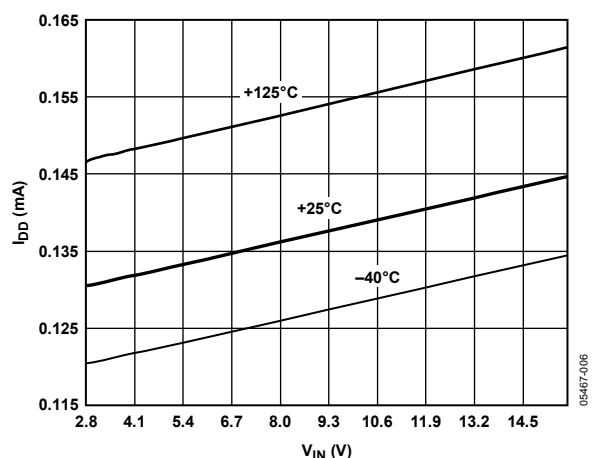

Figure 8. ADR361 Supply Current (I_{DD}) vs. V_{IN}

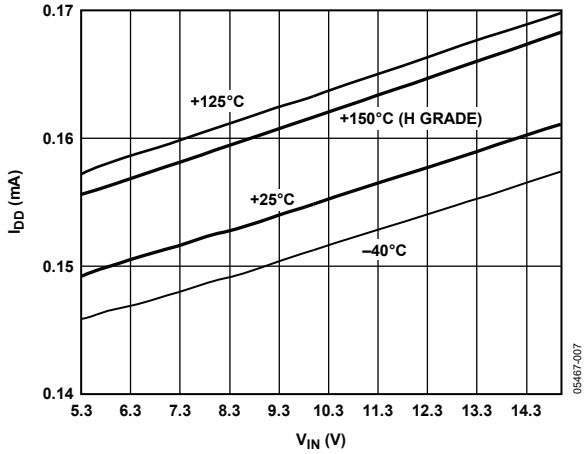

Figure 9. ADR365 I_{DD} vs. V_{IN}



Figure 12. ADR365 H Grade Load Regulation vs. Temperature

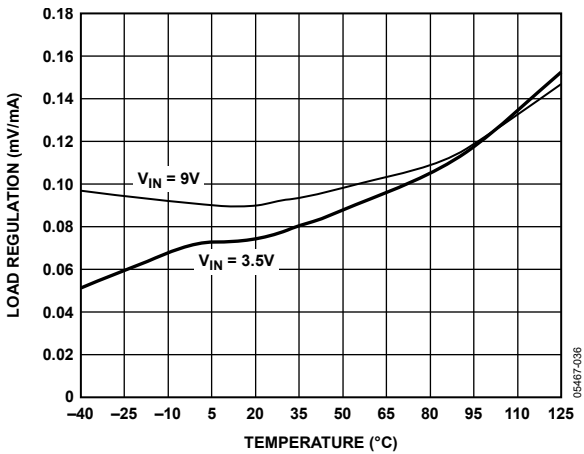

Figure 10. ADR361 Load Regulation vs. Temperature

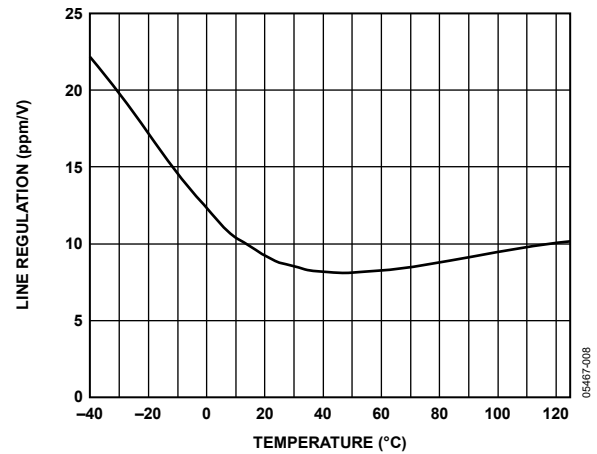

Figure 13. ADR360 Line Regulation vs. Temperature, $V_{IN} = 2.45 V$ to $15 V$

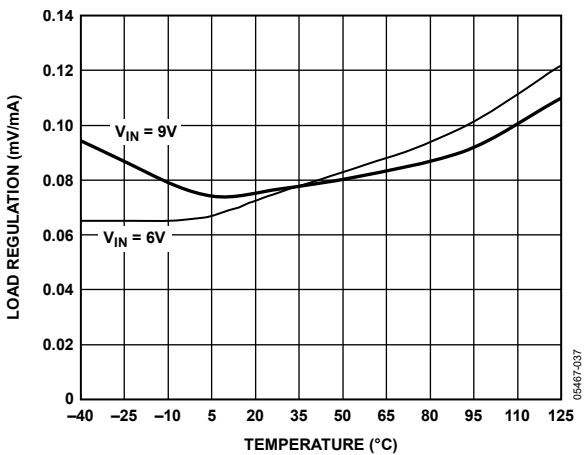

Figure 11. ADR365 Load Regulation vs. Temperature

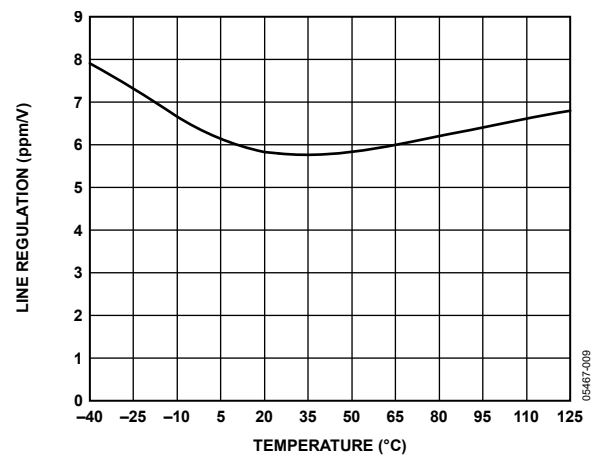

Figure 14. ADR361 Line Regulation vs. Temperature, $V_{IN} = 2.8 V$ to $15 V$

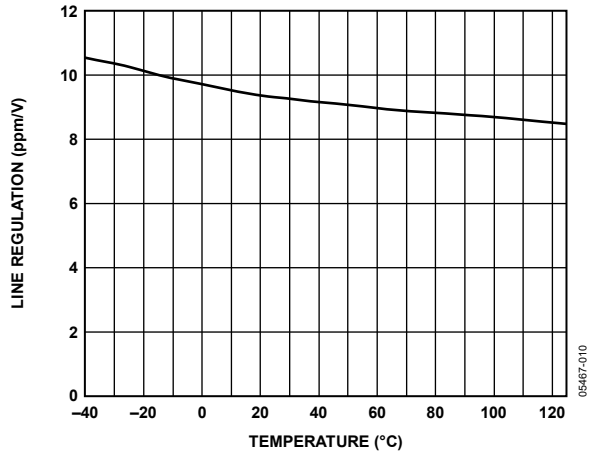

Figure 15. ADR365 Line Regulation vs. Temperature, $V_{IN} = 5.3\text{ V to }15\text{ V}$

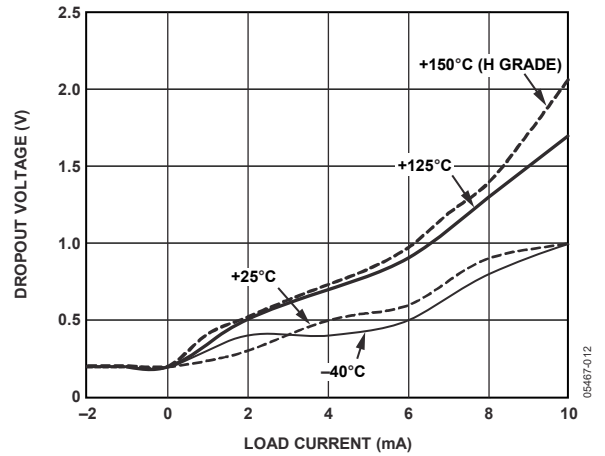

Figure 18. ADR365 Dropout Voltage vs. Load Current

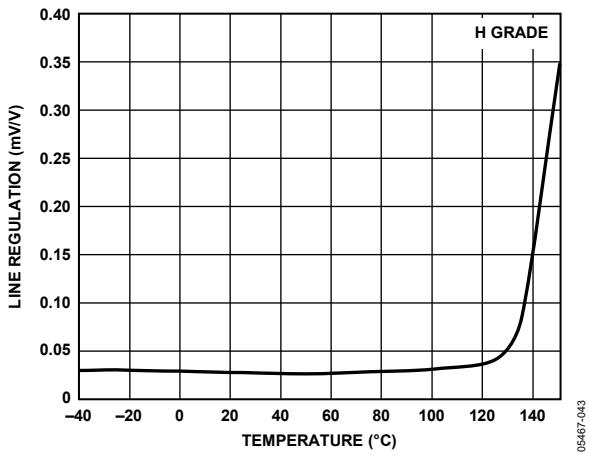

Figure 16. ADR365 H Grade Line Regulation vs. Temperature, $V_{IN} = 5.3\text{ V to }15\text{ V}$

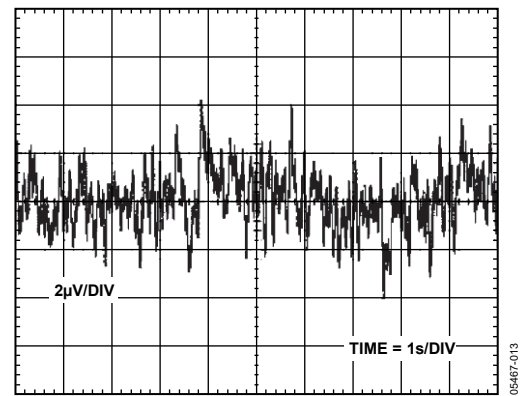

Figure 19. ADR361 0.1 Hz to 10 Hz Noise

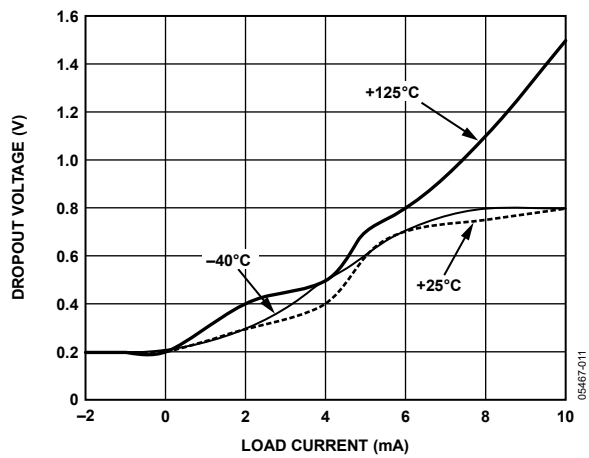

Figure 17. ADR361 Dropout Voltage vs. Load Current

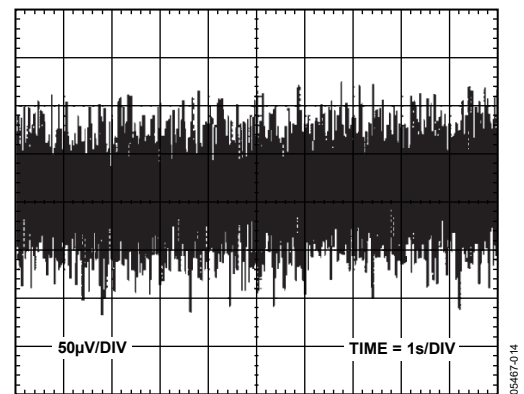

Figure 20. ADR361 10 Hz to 10 kHz Noise

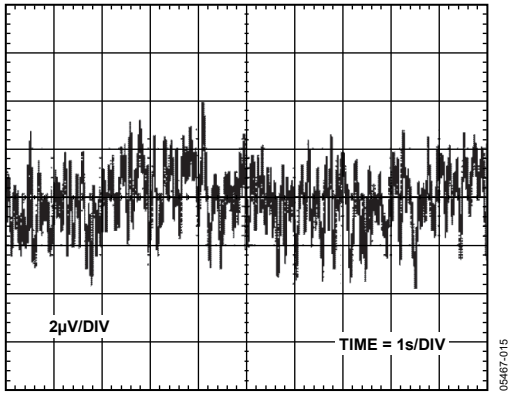

Figure 21. ADR363 0.1 Hz to 10 Hz Noise

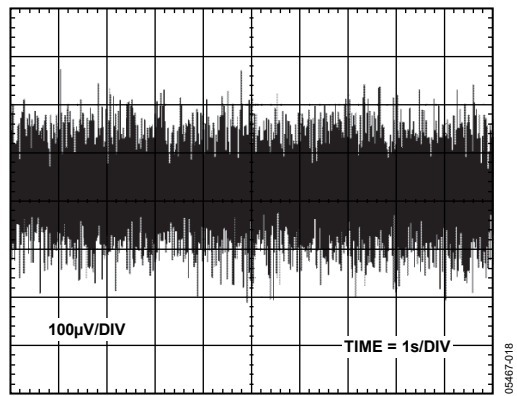

Figure 24. ADR365 10 Hz to 10 kHz Noise

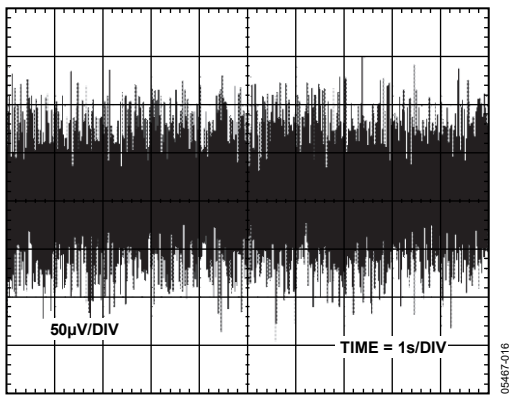

Figure 22. ADR363 10 Hz to 10 kHz Noise

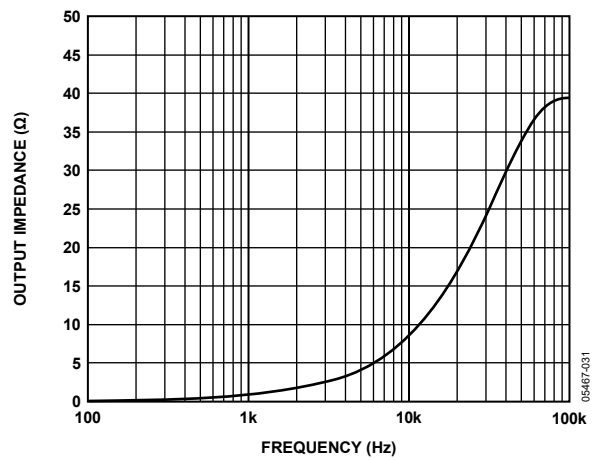

Figure 25. Output Impedance vs. Frequency

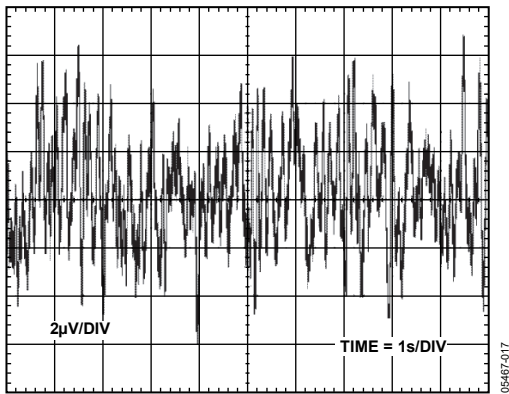

Figure 23. ADR365 0.1 Hz to 10 Hz Noise

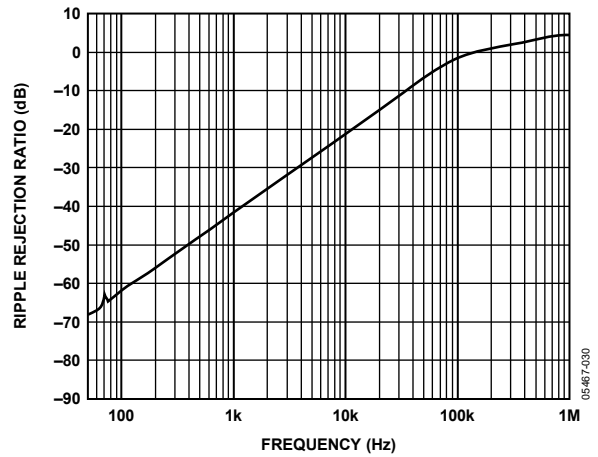

Figure 26. Ripple Rejection Ratio vs. Frequency

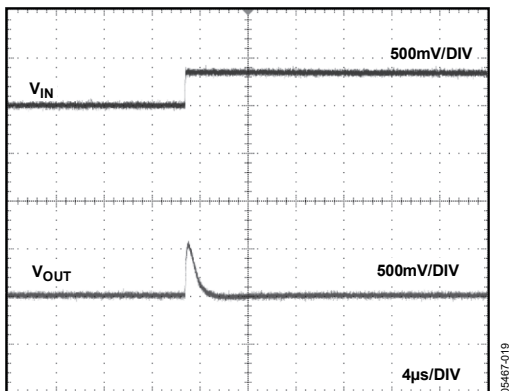

Figure 27. ADR361 Line Transient Response (Increasing), No Capacitors

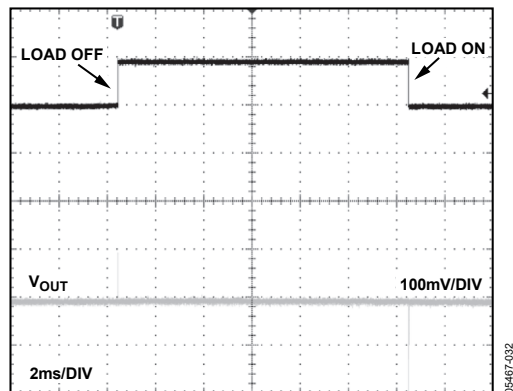

Figure 30. ADR361 Load Transient Response

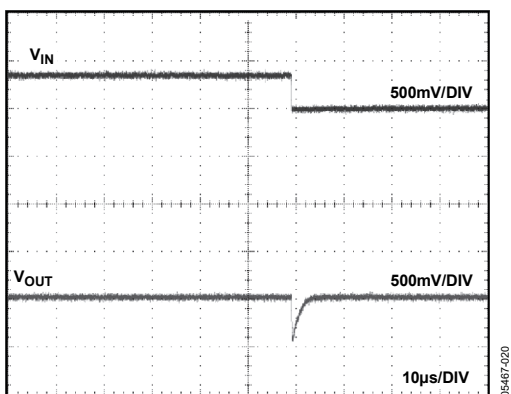

Figure 28. ADR361 Line Transient Response (Decreasing), No Capacitors

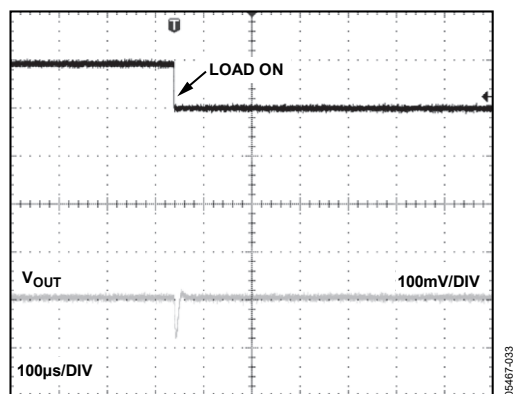

Figure 31. ADR361 Load Transient Response with 0.1 μ F Output Capacitor

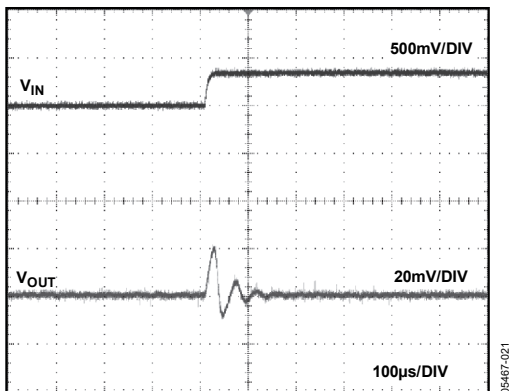

Figure 29. ADR361 Line Transient Response, 0.1 μ F Input Capacitor

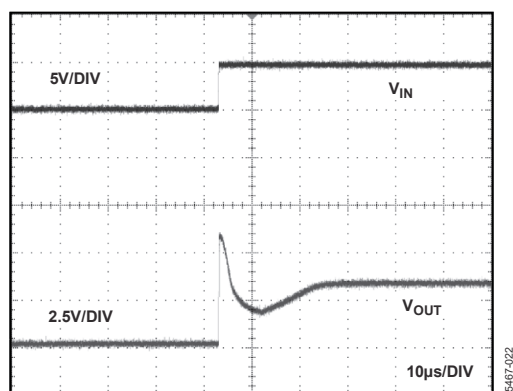

Figure 32. ADR361 Turn On Response Time at 5 V

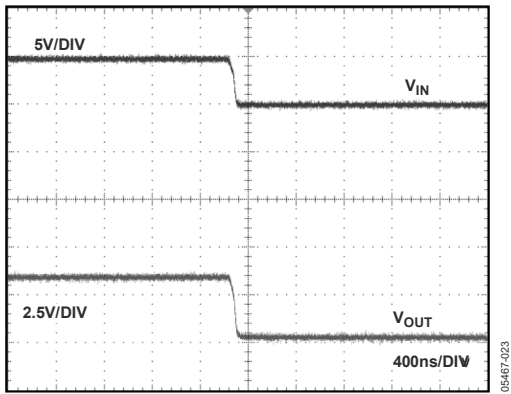

Figure 33. ADR361 Turn Off Response Time at 5 V

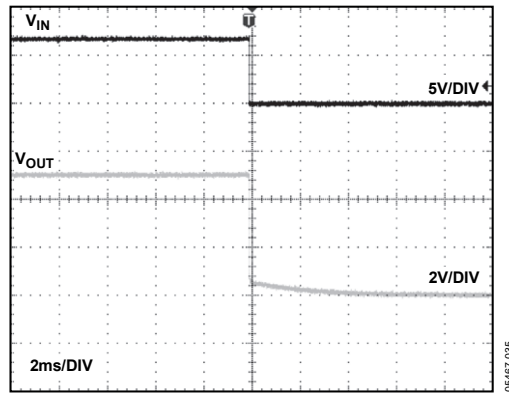

Figure 35. ADR361 Turn Off Response Time, 0.1 μ F Output Capacitor

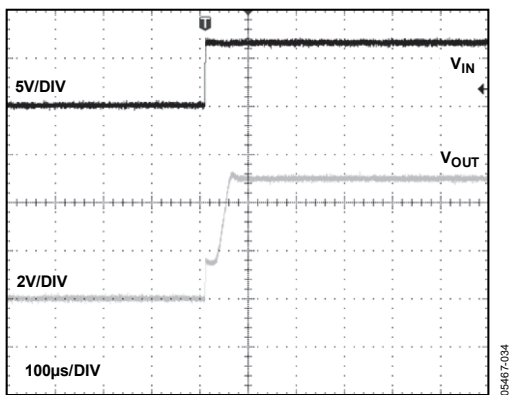

Figure 34. ADR361 Turn On Response Time, 0.1 μ F Output Capacitor

TERMINOLOGY

Temperature Coefficient

The temperature coefficient is the change of output voltage with respect to operating temperature changes normalized by the output voltage at 25°C. This parameter is expressed in ppm/°C and can be determined by

$$TCV_{OUT}(\text{ppm}/^{\circ}\text{C}) = \frac{V_{OUT}(T2) - V_{OUT}(T1)}{V_{OUT}(25^{\circ}\text{C}) \times (T2 - T1)} \times 10^6$$

where:

$V_{OUT}(T2)$ = V_{OUT} at Temperature 2.

$V_{OUT}(T1)$ = V_{OUT} at Temperature 1.

$V_{OUT}(25^{\circ}\text{C})$ = V_{OUT} at 25°C.

Line Regulation

Line regulation is the change in output voltage due to a specified change in input voltage. This parameter accounts for the effects of self heating. Line regulation is expressed in either percent per volt, parts per million per volt, or microvolts per volt change in input voltage.

Load Regulation

Load regulation is the change in output voltage due to a specified change in load current. This parameter accounts for the effects of self heating. Load regulation is expressed in either microvolts per milliampere, parts per million per milliampere, or ohms of dc output resistance.

Long-Term Stability

Long-term stability is the typical shift of output voltage at 25°C on a sample of devices subjected to a test of 1000 hours at 25°C.

$$\Delta V_{OUT} = V_{OUT}(t_0) - V_{OUT}(t_1)$$

$$\Delta V_{OUT}(\text{ppm}) = \left(\frac{V_{OUT}(t_0) - V_{OUT}(t_1)}{V_{OUT}(t_0)} \times 10^6 \right)$$

where:

$V_{OUT}(t_0)$ = V_{OUT} at 25°C at Time 0.

$V_{OUT}(t_1)$ = V_{OUT} at 25°C after 1000 hours operation at 25°C.

Thermal Hysteresis

Thermal hysteresis (V_{OUT_HYS}) is the change of output voltage after the device is cycled from +25°C to -40°C to +125°C and back to +25°C. This is a typical value from a sample of devices put through this cycle.

$$V_{OUT_HYS} = V_{OUT}(25^{\circ}\text{C}) - V_{OUT_TC}$$

$$V_{OUT_HYS}(\text{ppm}) = \frac{V_{OUT}(25^{\circ}\text{C}) - V_{OUT_TC}}{V_{OUT}(25^{\circ}\text{C})} \times 10^6$$

where:

$V_{OUT}(25^{\circ}\text{C})$ = V_{OUT} at 25°C.

V_{OUT_TC} = V_{OUT} at 25°C after a temperature cycle at +25°C to -40°C to +125°C and back to +25°C.

THEORY OF OPERATION

Band gap references are the high performance solution for low supply voltage and low power voltage reference applications, and the ADR360/ADR361/ADR363/ADR364/ADR365/ADR366 family is no exception. The uniqueness of these devices lies in their architecture. The ideal zero temperature coefficient band gap voltage is referenced to the output, not to ground (see Figure 36). Therefore, if noise exists on the ground line, the noise is greatly attenuated on V_{OUT}. The band gap cell consists of the PNP transistor pair, Q53 and Q52, running at unequal current densities. The difference in the base emitter voltage (V_{BE}) of Q53 and Q52 results in a voltage with a positive temperature coefficient, which is amplified by a ratio of

$$2 \times (R59/R54)$$

This proportional to absolute temperature (PTAT) voltage, combined with the V_{BE} of Q53 and Q52, produces the stable band gap voltage.

Reduction in the band gap curvature is performed by the ratio of Resistor R44 and Resistor R59, one of which is linearly temperature dependent. Precision laser trimming and other proprietary circuit techniques are used to further enhance the drift performance.

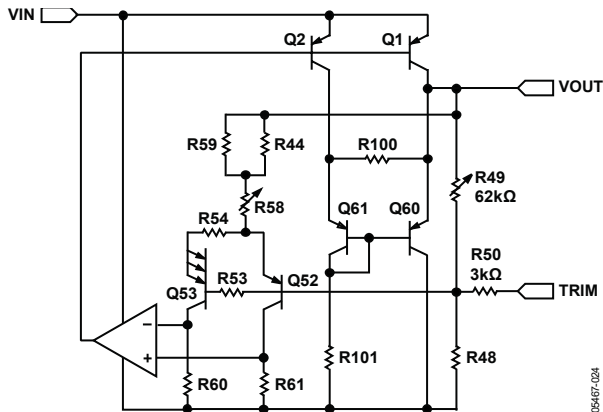

Figure 36. Simplified Schematic

05467-024

DEVICE POWER DISSIPATION CONSIDERATIONS

The ADR360/ADR361/ADR363/ADR364/ADR365/ADR366 family can deliver load currents up to 5 mA with an input voltage ranging from 2.35 V (ADR360 only) to 15 V. When the ADR360/ADR361/ADR363/ADR364/ADR365/ADR366 devices are used in applications with large input voltages, take care to avoid exceeding the specified maximum power dissipation or junction temperature because this may result in premature device failure. Use the following formula to calculate the maximum junction temperature or dissipation of a device:

$$P_D = \frac{T_J - T_A}{\theta_{JA}}$$

where:

P_D is the device power dissipation.

T_J and T_A are the junction and ambient temperatures, respectively.

θ_{JA} is the device package thermal resistance.

INPUT CAPACITOR

Input capacitors are not required on the ADR360/ADR361/ADR363/ADR364/ADR365/ADR366. There is no limit for the value of the capacitor used on the input, but a 1 μF to 10 μF capacitor on the input improves transient response in applications where the supply suddenly changes. An additional 0.1 μF capacitor in parallel also helps reduce noise from the supply.

OUTPUT CAPACITOR

The ADR360/ADR361/ADR363/ADR364/ADR365/ADR366 do not require output capacitors for stability under any load condition. An output capacitor, typically 0.1 μF, filters out low level noise voltage and does not affect the operation of the device. However, the load transient response can improve with an additional 1 μF to 10 μF output capacitor placed in parallel with the 0.1 μF capacitor. The additional capacitor acts as a source of stored energy for a sudden increase in load current, and the only parameter that degrades is the turn on time. The amount of degradation depends on the size of the capacitor chosen.

APPLICATIONS INFORMATION

BASIC VOLTAGE REFERENCE CONNECTION

The circuit in Figure 37 illustrates the basic configuration for the ADR360/ADR361/ADR363/ADR364/ADR365/ADR366 family. Decoupling capacitors are not required for circuit stability. The ADR360/ADR361/ADR363/ADR364/ADR365/ADR366 family can drive capacitive loads from 0 μ F to 10 μ F. However, a 0.1 μ F ceramic output capacitor is recommended to absorb and deliver the charge, as is required by a dynamic load.

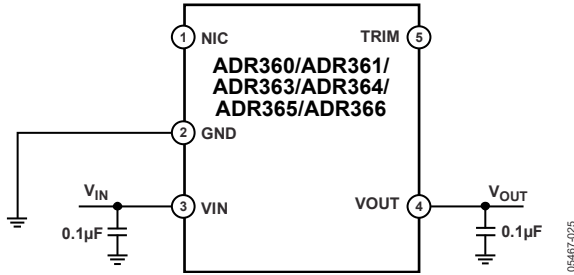

Figure 37. Basic Configuration for the ADR360/ADR361/ADR363/ADR364/ADR365/ADR366 Family

Stacking Reference ICs for Arbitrary Outputs

Some applications require two reference voltage sources, which are a combined sum of standard outputs. Figure 38 shows how this stacked output reference can be implemented.

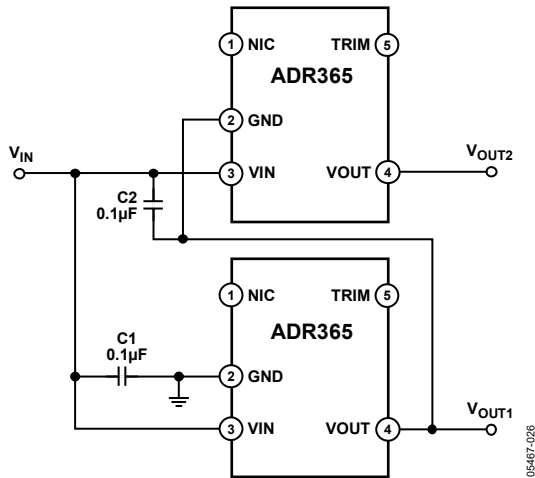

Figure 38. Stacking Voltage References with the ADR365

Two ADR365 devices are used and fed from an unregulated input, V_{IN} . The outputs of the individual ICs are connected in series, which provides two output voltages, V_{OUT1} and V_{OUT2} . V_{OUT1} is the terminal voltage of U1, and V_{OUT2} is the sum of this voltage and the terminal voltage of U2. U1 and U2 are chosen for the two voltages that supply the required outputs (see Table 11). For example, if both U1 and U2 are ADR361 devices, V_{OUT1} is 2.5 V and V_{OUT2} is 5.0 V.

Table 11. Output

U1/U2	V_{OUT1} (V)	V_{OUT2} (V)
ADR361/ADR365	2.5	7.5
ADR361/ADR361	2.5	5.0
ADR365/ADR361	5	7.5

General-Purpose Current Source

Often in low power applications, the need arises for a precision current source that can operate on low supply voltages. The ADR360/ADR361/ADR363/ADR364/ADR365/ADR366 can be configured as a precision current source (see Figure 39). The circuit configuration illustrated in Figure 39 is a floating current source with a grounded load. The output voltage of the reference is bootstrapped across R_{SET} , which sets the output current of the load. With this configuration, circuit precision is maintained for load currents ranging from the supply current of the reference, typically 150 μ A, up to approximately 5 mA. In Figure 39, I_{SY} is the supply current of the reference and I_{SET} is the required current output from the reference.

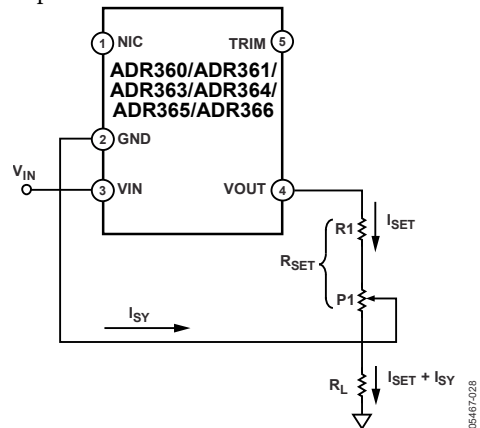

Figure 39. Floating Current Source

Trim Terminal

The ADR360/ADR361/ADR363/ADR364/ADR365/ADR366 trim terminal can be used to adjust the output voltage over a nominal voltage. This feature allows a system designer to trim system errors by setting the reference to a voltage other than the standard voltage option. Resistor R1 is used for fine adjustments and can be omitted if desired. Carefully choose the resistor values to ensure that the maximum current drive of the device is not exceeded.

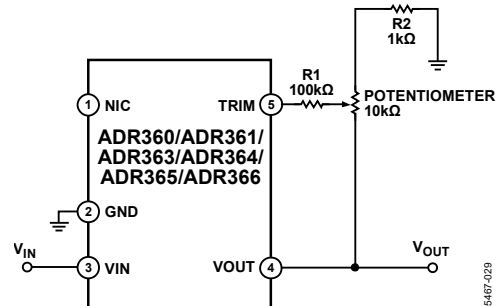

Figure 40. ADR360/ADR361/ADR363/ADR364/ADR365/ADR366 Trim Configuration

OUTLINE DIMENSIONS



COMPLIANT TO JEDEC STANDARDS MO-193-AB

Figure 41. 5-Lead Thin Small Outline Transistor Package [TSOT] (UJ-5)
Dimensions shown in millimeters

ORDERING GUIDE

Model ^{1, 2}	Output Voltage (V _{OUT})	Initial Accuracy, ±		Temperature Coefficient (ppm/°C)	Package Description	Package Option	Temperature Range	Ordering Quantity	Marking Code
		(mV)	(%)						
ADR360AUJZ-REEL7	2.048	6	0.29	25	5-Lead TSOT	UJ-5	-40°C to +125°C	3,000	ROC
ADR360BUJZ-REEL7	2.048	3	0.15	9	5-Lead TSOT	UJ-5	-40°C to +125°C	3,000	ROD
ADR361AUJZ-REEL7	2.5	6	0.24	25	5-Lead TSOT	UJ-5	-40°C to +125°C	3,000	ROE
ADR361BUJZ-REEL7	2.5	3	0.12	9	5-Lead TSOT	UJ-5	-40°C to +125°C	3,000	ROF
ADR363AUJZ-REEL7	3.0	6	0.2	25	5-Lead TSOT	UJ-5	-40°C to +125°C	3,000	ROG
ADR363BUJZ-REEL7	3.0	3	0.1	9	5-Lead TSOT	UJ-5	-40°C to +125°C	3,000	ROH
ADR364AUJZ-REEL7	4.096	8	0.2	25	5-Lead TSOT	UJ-5	-40°C to +125°C	3,000	ROJ
ADR364BUJZ-REEL7	4.096	4	0.1	9	5-Lead TSOT	UJ-5	-40°C to +125°C	3,000	ROK
ADR365AUJZ-REEL7	5.0	8	0.16	25	5-Lead TSOT	UJ-5	-40°C to +125°C	3,000	ROL
ADR365BUJZ-REEL7	5.0	4	0.08	9	5-Lead TSOT	UJ-5	-40°C to +125°C	3,000	ROM
ADR365WUJZ-R7	5.0	8	0.16	25	5-Lead TSOT	UJ-5	-40°C to +125°C	3,000	R0L
ADR365WHUJZ-R7	5.0	8	0.16	25	5-Lead TSOT	UJ-5	-40°C to +150°C	3,000	R3M
ADR366AUJZ-REEL7	3.3	8	0.25	25	5-Lead TSOT	UJ-5	-40°C to +125°C	3,000	R08
ADR366BUJZ-REEL7	3.3	4	0.125	9	5-Lead TSOT	UJ-5	-40°C to +125°C	3,000	R09
ADR366WUJZ-REEL7	3.3	8	0.25	25	5-Lead TSOT	UJ-5	-40°C to +125°C	3,000	R08

¹ Z = RoHS Compliant Part.
² W = Qualified for Automotive Applications.

AUTOMOTIVE PRODUCTS

The ADR365W and ADR366W models are available with controlled manufacturing to support the quality and reliability requirements of automotive applications. Note that these automotive models may have specifications that differ from the commercial models; therefore, designers should review the Specifications section of this data sheet carefully. Only the automotive grade products shown are available for use in automotive applications. Contact your local Analog Devices account representative for specific product ordering information and to obtain the specific Automotive Reliability reports for these models.

Looking for pricing, stock, or lifecycle information?

Click below to explore more details on WIN SOURCE:

 [View ADR366WAUJZ-REEL7 on WIN SOURCE](#)

 [Analog Devices Inc. Information](#)

Optimize Your Supply Chain with WIN SOURCE Solutions

-  Global Sourcing Solution
-  Obsolete Management
-  Cost Control Management
-  Shortage Management
-  Alternative Solution
-  Excess Inventory Management