



**THE DATASHEET OF  
LM27964SQ-A/NOPB**



# LM27964 White LED Driver System with I<sup>2</sup>C Compatible Brightness Control

Check for Samples: [LM27964](#)

## FEATURES

- 87% Peak LED Drive Efficiency
- 0.2% Current Matching between Current Sinks
- Drives 6 LEDs with up to 30mA per LED in Two Distinct Groups, for Backlighting Two Displays (main LCD and sub LCD)
- Dedicated Keypad LED Driver with up to 80mA of Drive Current
- Independent Resistor-Programmable Current Settings
- I<sup>2</sup>C Compatible Brightness Control Interface
- Adaptive 1x- 3/2x Charge Pump
- Extended Li-Ion Input: 2.7V to 5.5V
- Small Low Profile Industry Standard Leadless Package, WQFN-24 : (4mm x 4mm x 0.8mm)
- LM27964SQ-I LED PWM Frequency = 10kHz, LM27964SQ-C LED PWM frequency = 23kHz

## APPLICATIONS

- Mobile Phone Display Lighting
- Mobile Phone Keypad Lighting
- PDAs Backlighting
- General LED Lighting

## DESCRIPTION

The LM27964 is a charge-pump-based white-LED driver that is ideal for mobile phone display backlighting. The LM27964 can drive up to 6 LEDs in parallel along with multiple keypad LEDs, with a total output current up to 180mA. Regulated internal current sources deliver excellent current matching in all LEDs.

The LED driver current sources are split into two independently controlled groups. The primary group (4 LEDs) can be used to backlight the main phone display and the second group (2 LEDs) can be used to backlight a secondary display. A single Keypad LED driver can power up to 16 keypad LEDs with a current of 5mA each. The LM27964 has an I<sup>2</sup>C compatible interface that allows the user to independently control the brightness on each bank of LEDs.

## Typical Application Circuit

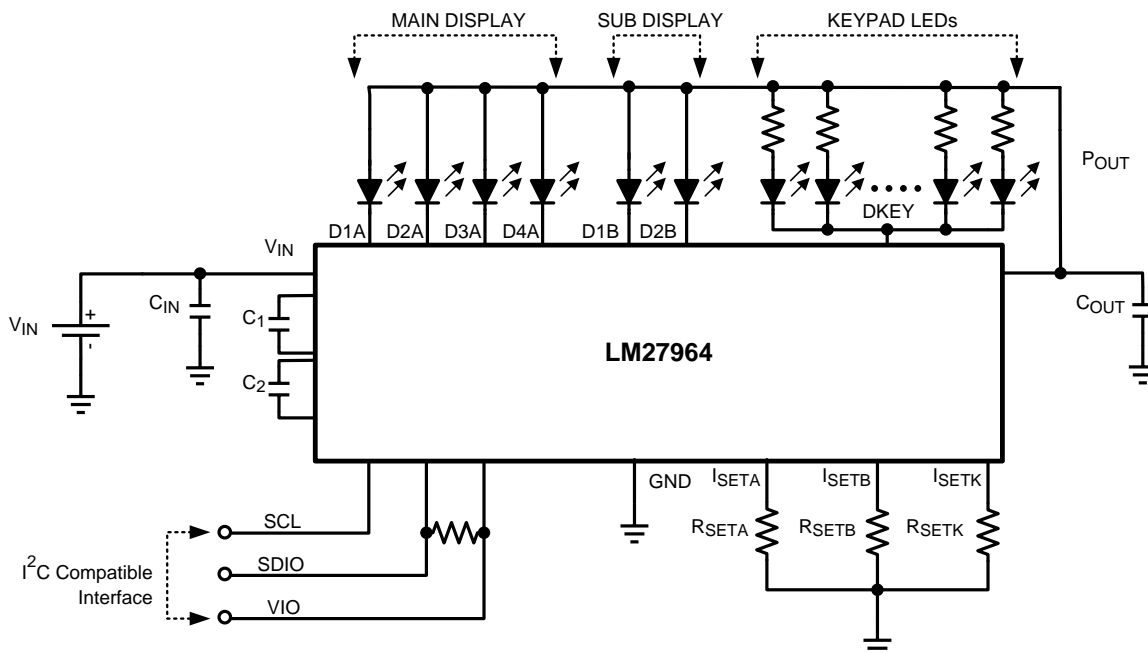

Please be aware that an important notice concerning availability, standard warranty, and use in critical applications of Texas Instruments semiconductor products and disclaimers thereto appears at the end of this data sheet.

All trademarks are the property of their respective owners.

## DESCRIPTION (CONTINUED)

The LM27964 works off an extended Li-Ion input voltage range (2.7V to 5.5V). The device provides excellent efficiency without the use of an inductor by operating the charge pump in a gain of 3/2, or in Pass-Mode. The proper gain for maintaining current regulation is chosen, based on LED forward voltage, so that efficiency is maximized over the input voltage range.

The LM27964 is available in TI's small 24-pin WQFN Package (WQFN-24).

## Connection Diagram

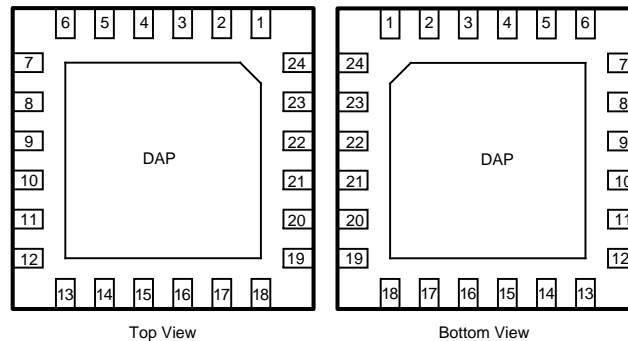

**Figure 1. 24 Pin Quad WQFN Package**  
See Package Number RTW0024A

**Table 1. Pin Descriptions**

Pin #s	Pin Names	Pin Descriptions
24	V <sub>IN</sub>	Input voltage. Input range: 2.7V to 5.5V.
23	P <sub>OUT</sub>	Charge Pump Output Voltage
19, 22 (C1) 20, 21 (C2)	C1, C2	Flying Capacitor Connections
13, 14, 15, 16	D4A, D3A, D2A, D1A	LED Drivers - GroupA
4, 5	D1B, D2B	LED Drivers - GroupB
6	DKEY	LED Driver - KEYPAD
17	I <sub>SETA</sub>	Placing a resistor (R <sub>SETA</sub> ) between this pin and GND sets the full-scale LED current for Group A LEDs. LED Current = $200 \times (1.25V \div R_{SETA})$
3	I <sub>SETB</sub>	Placing a resistor (R <sub>SETB</sub> ) between this pin and GND sets the full-scale LED current for Group B LEDs. LED Current = $200 \times (1.25V \div R_{SETB})$
12	I <sub>SETK</sub>	Placing a resistor (R <sub>SETK</sub> ) between this pin and GND sets the total LED current for the KEYPAD LEDs. Keypad LED Current = $800 \times (1.25V \div R_{SETK})$
1	SCL	Serial Clock Pin
2	SDIO	Serial Data Input/Output Pin
7	VIO	Serial Bus Voltage Level Pin
9, 10, 18, DAP	GND	Ground
8, 11	NC	No Connect

### Absolute Maximum Ratings<sup>(1)(2)(3)</sup>

$V_{IN}$ pin voltage		-0.3V to 6.0V
SCL, SDIO, VIO pin voltages		-0.3V to $(V_{IN}+0.3V)$ w/ 6.0V max
$I_{DXX}$ Pin Voltages		-0.3V to $(V_{POUT}+0.3V)$ w/ 6.0V max
Continuous Power Dissipation <sup>(4)</sup>		Internally Limited
Junction Temperature ( $T_{J-MAX}$ )		150°C
Storage Temperature Range		-65°C to +150° C
Maximum Lead Temperature (Soldering)		See <sup>(5)</sup>
ESD Rating <sup>(6)</sup>	Human Body Model - $I_{DXX}$ Pins:	1.0kV
	Human Body Model - All other Pins:	2.0kV

- (1) Absolute Maximum Ratings indicate limits beyond which damage to the component may occur. Operating Ratings are conditions under which operation of the device is ensured. Operating Ratings do not imply ensured performance limits. For ensured performance limits and associated test conditions, see the Electrical Characteristics tables.
- (2) All voltages are with respect to the potential at the GND pin.
- (3) If Military/Aerospace specified devices are required, please contact the Texas Instruments Sales Office/ Distributors for availability and specifications.
- (4) Internal thermal shutdown circuitry protects the device from permanent damage. Thermal shutdown engages at  $T_J = 170^\circ\text{C}$  (typ.) and disengages at  $T_J = 165^\circ\text{C}$  (typ.).
- (5) For detailed soldering specifications and information, see the TI AN-1187 Application Report ([SNOA401](#)).
- (6) The Human body model is a 100pF capacitor discharged through a 1.5k $\Omega$  resistor into each pin. MIL-STD-883 3015.7

### Operating Rating<sup>(1)(2)</sup>

Input Voltage Range	2.7V to 5.5V
LED Voltage Range	2.0V to 4.0V
Junction Temperature ( $T_J$ ) Range	-30°C to +100°C
Ambient Temperature ( $T_A$ ) Range <sup>(3)</sup>	-30°C to +85°C

- (1) Absolute Maximum Ratings indicate limits beyond which damage to the component may occur. Operating Ratings are conditions under which operation of the device is ensured. Operating Ratings do not imply ensured performance limits. For ensured performance limits and associated test conditions, see the Electrical Characteristics tables.
- (2) All voltages are with respect to the potential at the GND pin.
- (3) In applications where high power dissipation and/or poor package thermal resistance is present, the maximum ambient temperature may have to be derated. Maximum ambient temperature ( $T_{A-MAX}$ ) is dependent on the maximum operating junction temperature ( $T_{J-MAX-OP} = 100^\circ\text{C}$ ), the maximum power dissipation of the device in the application ( $P_{D-MAX}$ ), and the junction-to ambient thermal resistance of the part/package in the application ( $\theta_{JA}$ ), as given by the following equation:  $T_{A-MAX} = T_{J-MAX-OP} - (\theta_{JA} \times P_{D-MAX})$ .

### Thermal Properties

Junction-to-Ambient Thermal Resistance ( $\theta_{JA}$ ), RTW0024A Package <sup>(1)</sup>	41.3°C/W
---	----------

- (1) Junction-to-ambient thermal resistance is highly dependent on application and board layout. In applications where high maximum power dissipation exists, special care must be paid to thermal dissipation issues in board design. For more information, see the TI AN-1187 Application Report ([SNOA401](#)).

## Electrical Characteristics<sup>(1)(2)</sup>

Limits in standard typeface are for  $T_J = 25^\circ\text{C}$ , and limits in boldface type apply over the full operating temperature range. Unless otherwise specified:  $V_{IN} = 3.6\text{V}$ ;  $V_{DxA} = 0.4\text{V}$ ;  $V_{DxB} = 0.4\text{V}$ ;  $V_{DKEY} = 0.4\text{V}$ ;  $R_{SETA} = R_{SETB} = R_{SETK} = 16.9\text{k}\Omega$ ; BankA, BankB, and DKEY = Fullscale Current; ENA, ENB, ENK Bits = "1";  $C_1=C_2=1.0\mu\text{F}$ ,  $C_{IN}=C_{OUT}=2.2\mu\text{F}$ ; Specifications related to output current(s) and current setting pins ( $I_{Dxx}$  and  $I_{SETx}$ ) apply to BankA, BankB and DKEY.<sup>(3)</sup>

Symbol	Parameter	Condition	Min	Typ	Max	Units
$I_{Dxx}$	Output Current Regulation BankA or BankB Enabled	$3.0\text{V} \leq V_{IN} \leq 5.5\text{V}$ BankA or BankB Full-Scale ENA or ENB = "1", ENK = "0"	<b>13.77</b> <b>(-10%)</b>	15.3	<b>16.83</b> <b>(+10%)</b>	mA (%)
		$3.0\text{V} \leq V_{IN} \leq 5.5\text{V}$ BankA or BankB Half-Scale ENA or ENB = "1", ENK = "0"		7.5		mA
		$2.7\text{V} \leq V_{IN} \leq 3.0\text{V}$ BankA or BankB Full-Scale ENA or ENB = "1", ENK = "0"		15		mA
	Output Current Regulation Keypad Driver Enabled	$3.0\text{V} \leq V_{IN} \leq 5.5\text{V}$ DKEY Full-Scale ENA = ENB = "0", ENK = "1"	<b>52.8</b> <b>(-12%)</b>	60	<b>67.2</b> <b>(+12%)</b>	mA (%)
	Output Current Regulation BankA and DKEY Enabled <sup>(4)</sup>	$3.2\text{V} \leq V_{IN} \leq 5.5\text{V}$ $R_{SETA} = 8.3\text{k}\Omega$ , $R_{SETK} = 16.9\text{k}\Omega$ $V_{LED} = 3.6\text{V}$ BankA and DKEY Full-Scale ENA = ENK = "1", ENB = "0"		30 DxA		mA
			60 DKEY			
$R_{OUT}$	Open-Loop Charge Pump Output Resistance	Gain = 3/2		2.75		$\Omega$
		Gain = 1		1		
$V_{DxTH}$	$V_{Dxx}$ 1x to 3/2x Gain Transition Threshold	$V_{DxA}$ and/or $V_{DxB}$ Falling		375		mV
$V_{HR}$	Current Source Headroom Voltage Requirement <sup>(5)</sup>	$I_{Dxx} = 95\% \times I_{Dxx}(\text{nom.})$ ( $I_{Dxx}(\text{nom.}) \approx 15\text{mA}$ ) BankA and/or BankB Full-Scale Gain = 3/2, ENA and/or ENB = "1"		180		mV
		$I_{DKEY} = 95\% \times I_{DKEY}(\text{nom.})$ ( $I_{DKEY}(\text{nom.}) \approx 60\text{mA}$ ) DKEY Full-Scale Gain = 3/2, ENK = "1"		180		
$I_{Dxx-MATCH}$	LED Current Matching	See <sup>(6)</sup>		0.2	<b>2</b>	%
$I_Q$	Quiescent Supply Current	Gain = 1.5x, No Load		1.3	<b>1.7</b>	mA
$I_{SD}$	Shutdown Supply Current	All ENx bits = "0"		3.0	<b>5</b>	$\mu\text{A}$
$V_{SET}$	$I_{SET}$ Pin Voltage	$2.7\text{V} \leq V_{IN} \leq 5.5\text{V}$		1.25		V
$I_{DxA-B} / I_{SETA-B}$	Output Current to Current Set Ratio BankA and BankB			200		
$I_{DKEY} / I_{SETK}$	Output Current to Current Set Ratio DKEY			800		
$f_{SW}$	Switching Frequency		<b>500</b>	700	<b>900</b>	kHz
$t_{START}$	Start-up Time	$P_{OUT} = 90\%$ steady state		250		$\mu\text{s}$

- (1) All voltages are with respect to the potential at the GND pin.
- (2) Min and Max limits are specified by design, test, or statistical analysis. Typical numbers are not ensured, but do represent the most likely norm.
- (3)  $C_{IN}$ ,  $C_{POUT}$ ,  $C_1$ , and  $C_2$  : Low-ESR Surface-Mount Ceramic Capacitors (MLCCs) used in setting electrical characteristics
- (4) The maximum total output current for the LM27964 should be limited to 180mA. The total output current can be split among any of the three banks ( $I_{DxA} = I_{DxB} = 30\text{mA Max.}$ ,  $I_{DKEY} = 80\text{mA Max.}$ ). Under maximum output current conditions, special attention must be given to input voltage and LED forward voltage to ensure proper current regulation. See the Maximum Output Current section of the datasheet for more information.
- (5) For each  $I_{Dxx}$  output pin, headroom voltage is the voltage across the internal current sink connected to that pin. For Group A and B outputs,  $V_{HR} = V_{OUT} - V_{Dxx}$ . If headroom voltage requirement is not met, LED current regulation will be compromised.
- (6) For the two groups of outputs on a part (BankA and BankB), the following are determined: the maximum output current in the group (MAX), the minimum output current in the group (MIN), and the average output current of the group (AVG). For each group, two matching numbers are calculated: (MAX-AVG)/AVG and (AVG-MIN)/AVG. The largest number of the two (worst case) is considered the matching figure for the bank. The matching figure for a given part is considered to be the highest matching figure of the two banks. The typical specification provided is the most likely norm of the matching figure for all parts.

**Electrical Characteristics<sup>(1)(2)</sup>**  
**(continued)**

Limits in standard typeface are for  $T_J = 25^\circ\text{C}$ , and limits in boldface type apply over the full operating temperature range. Unless otherwise specified:  $V_{IN} = 3.6\text{V}$ ;  $V_{DxA} = 0.4\text{V}$ ;  $V_{DxB} = 0.4\text{V}$ ;  $V_{DKEY} = 0.4\text{V}$ ;  $R_{SETA} = R_{SETB} = R_{SETK} = 16.9\text{k}\Omega$ ; BankA, BankB, and DKEY = Fullscale Current; ENA, ENB, ENK Bits = "1";  $C1=C2=1.0\mu\text{F}$ ,  $C_{IN}=C_{OUT}=2.2\mu\text{F}$ ; Specifications related to output current(s) and current setting pins ( $I_{Dxx}$  and  $I_{SETx}$ ) apply to BankA, BankB and DKEY.<sup>(3)</sup>

Symbol	Parameter	Condition	Min	Typ	Max	Units
$f_{PWM}$	Internal Diode Current PWM Frequency	LM27964SQ-I		10		kHz
		LM27964SQ-C		23		
D.C. Step	Diode Current Duty Cycle Step			1/16		Fullscale
<b>I<sup>2</sup>C Compatible Interface Voltage Specifications (SCL, SDIO, VIO)</b>						
$V_{IO}$	Serial Bus Voltage Level		<b>1.8</b>		$V_{IN}$	V
$V_{IL}$	Input Logic Low "0"	$2.7\text{V} \leq V_{IN} \leq 5.5\text{V}$	<b>0</b>		$0.27 \times V_{IO}$	V
$V_{IH}$	Input Logic High "1"	$2.7\text{V} \leq V_{IN} \leq 5.5\text{V}$	$0.73 \times V_{IO}$		$V_{IO}$	V
$V_{OL}$	Output Logic Low "0"	$I_{LOAD} = 2\text{mA}$			<b>400</b>	mV
<b>I<sup>2</sup>C Compatible Interface Timing Specifications (SCL, SDIO, VIO)<sup>(7)</sup></b>						
$t_1$	SCL (Clock Period)		<b>2.5</b>			$\mu\text{s}$
$t_2$	Data In Setup Time to SCL High		<b>100</b>			ns
$t_3$	Data Out stable After SCL Low		<b>0</b>			ns
$t_4$	SDIO Low Setup Time to SCL Low (Start)		<b>100</b>			ns
$t_5$	SDIO High Hold Time After SCL High (Stop)		<b>100</b>			ns

(7) SCL and SDIO should be glitch-free in order for proper brightness control to be realized.

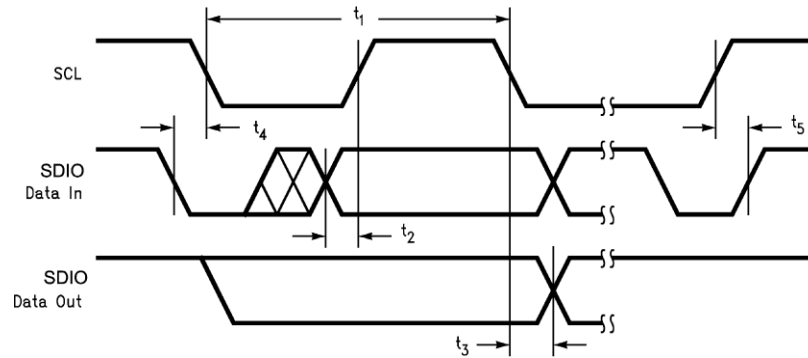

Block Diagram

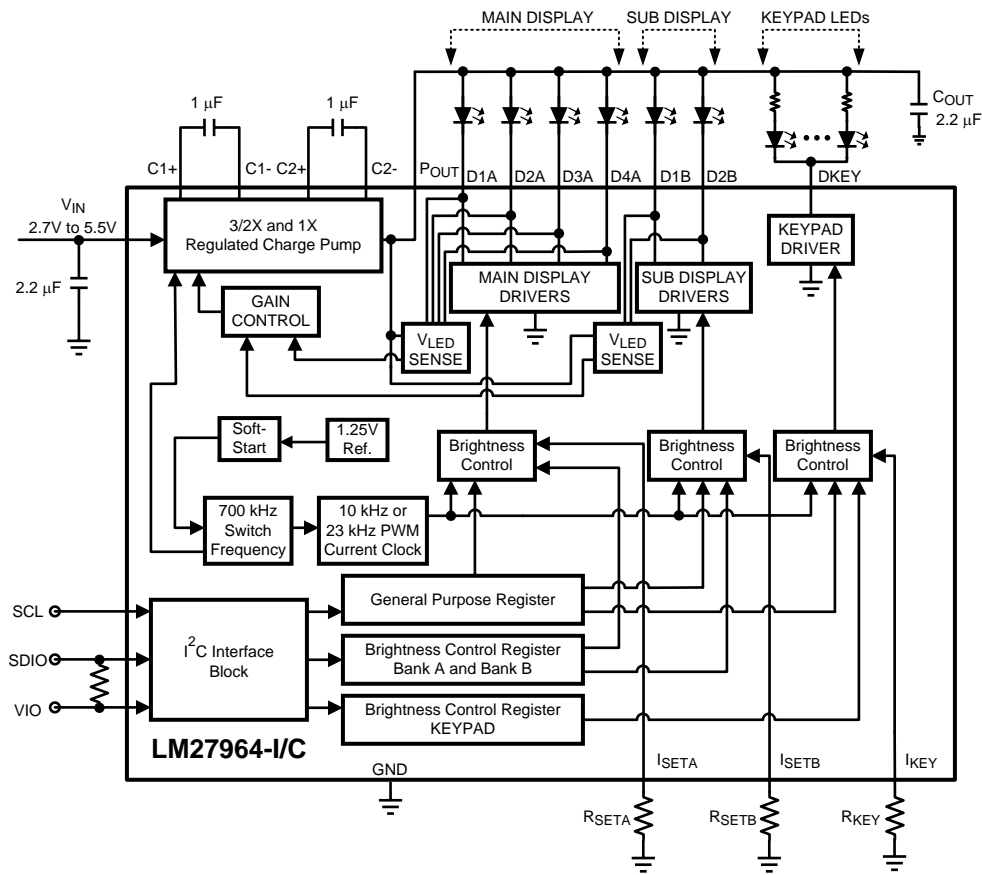

### Typical Performance Characteristics

Unless otherwise specified:  $V_{IN} = 3.6V$ ;  $V_{LEDxA} = 3.6V$ ,  $V_{LEDxB} = 3.6V$ ;  $R_{SETA} = R_{SETB} = R_{SETK} = 16.9k\Omega$ ;  $C_1=C_2=1\mu F$ , and  $C_{IN} = C_{POUT} = 2.2\mu F$ .

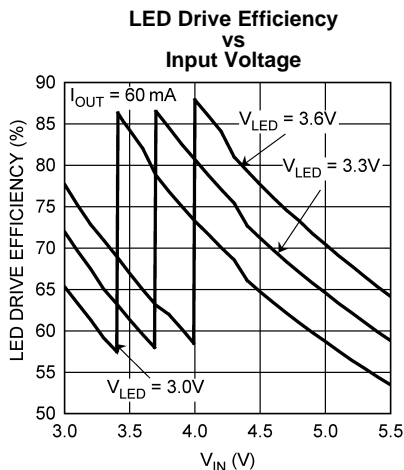

Figure 2.

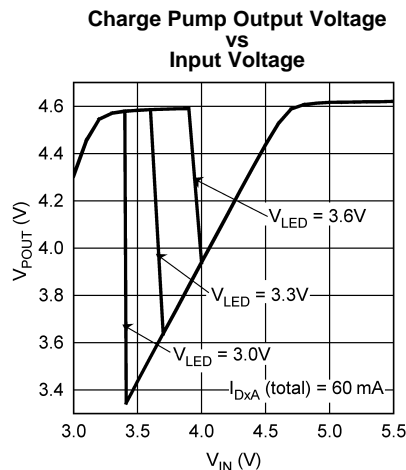

Figure 3.

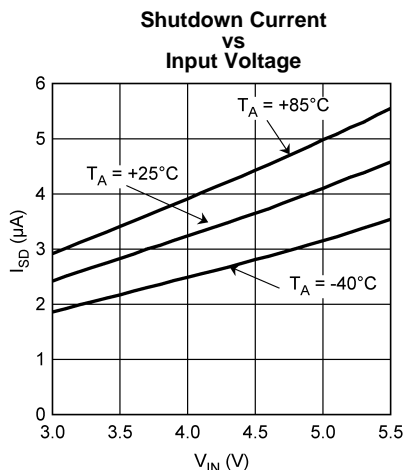

Figure 4.

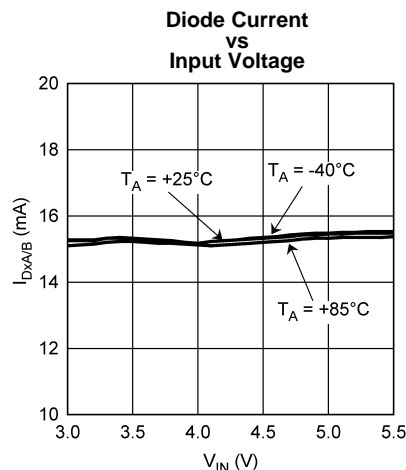

Figure 5.

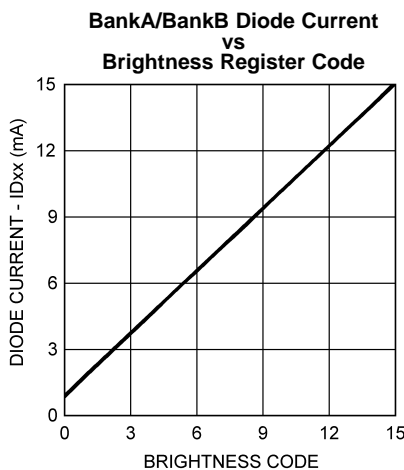

Figure 6.

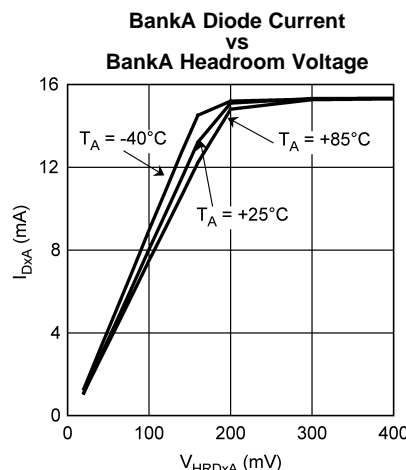

Figure 7.

**Typical Performance Characteristics (continued)**

Unless otherwise specified:  $V_{IN} = 3.6V$ ;  $V_{LEDxA} = 3.6V$ ,  $V_{LEDxB} = 3.6V$ ;  $R_{SETA} = R_{SETB} = R_{SETK} = 16.9k\Omega$ ;  $C_1=C_2=1\mu F$ , and  $C_{IN} = C_{POUT} = 2.2\mu F$ .

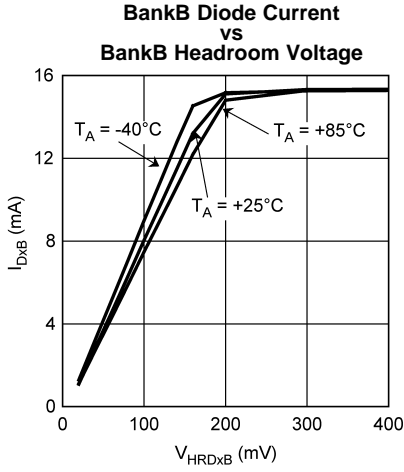

Figure 8.

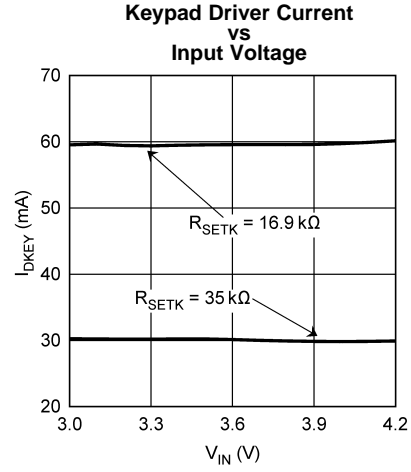

Figure 9.

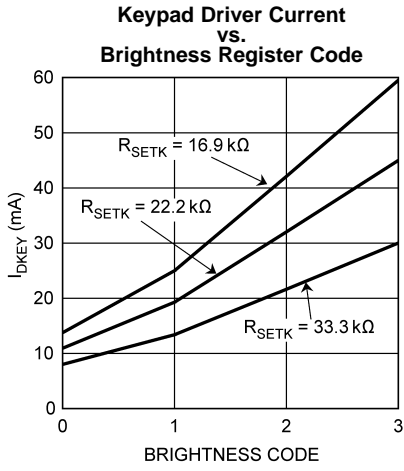

Figure 10.

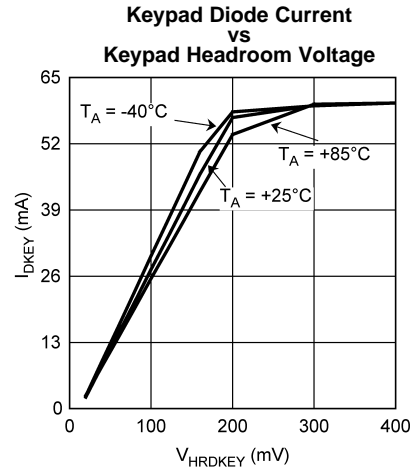

Figure 11.

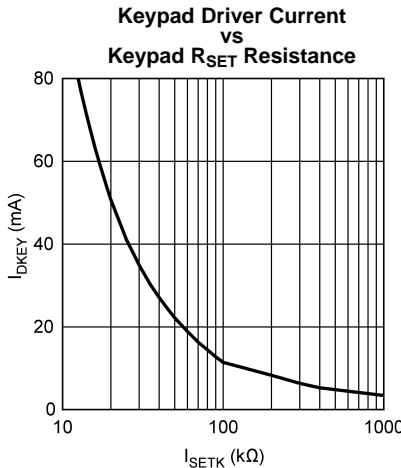

Figure 12.

## Circuit Description

### OVERVIEW

The LM27964 is a white LED driver system based upon an adaptive 1.5x/1x CMOS charge pump capable of supplying up to 180mA of total output current. With three separately controlled banks of constant current sinks, the LM27964 is an ideal solution for platforms requiring a single white LED driver for main and sub displays, as well as other general purpose lighting needs. The tightly matched current sinks ensure uniform brightness from the LEDs across the entire small-format display.

Each LED is configured in a common anode configuration, with the peak drive current being programmed through the use of external  $R_{SETX}$  resistors. An I<sup>2</sup>C compatible interface is used to enable and vary the brightness within the individual current sink banks. For BankA and BankB, 16 levels of PWM brightness control are available, while 4 analog levels are present for the DKEY driver.

### CIRCUIT COMPONENTS

#### Charge Pump

The input to the 1.5x/1x charge pump is connected to the  $V_{IN}$  pin, and the regulated output of the charge pump is connected to the  $V_{OUT}$  pin. The recommended input voltage range of the LM27964 is 3.0V to 5.5V. The device's regulated charge pump has both open loop and closed loop modes of operation. When the device is in open loop, the voltage at  $V_{OUT}$  is equal to the gain times the voltage at the input. When the device is in closed loop, the voltage at  $V_{OUT}$  is regulated to 4.6V (typ.). The charge pump gain transitions are actively selected to maintain regulation based on LED forward voltage and load requirements. This allows the charge pump to stay in the most efficient gain (1x) over as much of the input voltage range as possible, reducing the power consumed from the battery.

#### LED Forward Voltage Monitoring

The LM27964 has the ability to switch converter gains (1x or 3/2x) based on the forward voltage of the LED load. This ability to switch gains maximizes efficiency for a given load. Forward voltage monitoring occurs on all diode pins within BankA and BankB (DKEY is not monitored). At higher input voltages, the LM27964 will operate in pass mode, allowing the POUT voltage to track the input voltage. As the input voltage drops, the voltage on the DXX pins will also drop ( $V_{DXX} = V_{POUT} - V_{LEDx}$ ). Once any of the active Dxx pins reaches a voltage approximately equal to 375mV, the charge pump will then switch to the gain of 3/2. This switchover ensures that the current through the LEDs never becomes pinched off due to a lack of headroom on the current sources.

Only active Dxx pins will be monitored. For example, if only BankA is enabled, the LEDs in BankB will not affect the gain transition point. If both banks are enabled, all diodes will be monitored, and the gain transition will be based upon the diode with the highest forward voltage. The DKEY pin is not monitored as it is intended to be for keypad LEDs. Keypad LEDs generally require lower current, resulting in lower forward voltage compared to the BankA and BankB LEDs that have higher currents. In the event that only the DKEY driver is enabled without either BankA or BankB, the charge pump will default to 3/2 mode to ensure the DKEY driver has enough headroom.

It is not recommended that any of the BankA or BankB drivers be left disconnected if either bank will be used in the application. If Dxx pin/s are left unconnected, the LM27964 will default to the gain of 3/2. If the BankA or BankB drivers are not going to be used in the application, leaving the Dxx pins is acceptable as long as the ENx bit in the general purpose register is set to "0".

### I<sup>2</sup>C Compatible Interface

#### DATA VALIDITY

The data on SDIO line must be stable during the HIGH period of the clock signal (SCL). In other words, state of the data line can only be changed when CLK is LOW.

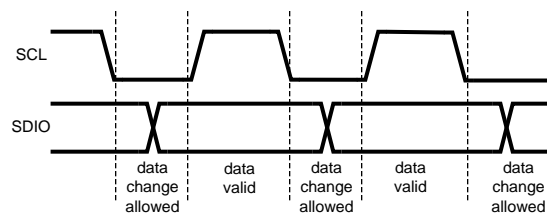
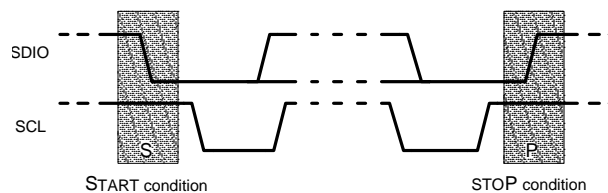

**Figure 13. Data Validity Diagram**

A pull-up resistor between V<sub>IO</sub> and SDIO must be greater than  $[(V_{IO}-V_{OL}) / 2mA]$  to meet the V<sub>OL</sub> requirement on SDIO. Using a larger pull-up resistor results in lower switching current with slower edges, while using a smaller pull-up results in higher switching currents with faster edges.

### START AND STOP CONDITIONS

START and STOP conditions classify the beginning and the end of the I<sup>2</sup>C session. A START condition is defined as SDIO signal transitioning from HIGH to LOW while SCL line is HIGH. A STOP condition is defined as the SDIO transitioning from LOW to HIGH while SCL is HIGH. The I<sup>2</sup>C master always generates START and STOP conditions. The I<sup>2</sup>C bus is considered to be busy after a START condition and free after a STOP condition. During data transmission, the I<sup>2</sup>C master can generate repeated START conditions. First START and repeated START conditions are equivalent, function-wise. The data on SDIO line must be stable during the HIGH period of the clock signal (SCL). In other words, the state of the data line can only be changed when CLK is LOW.

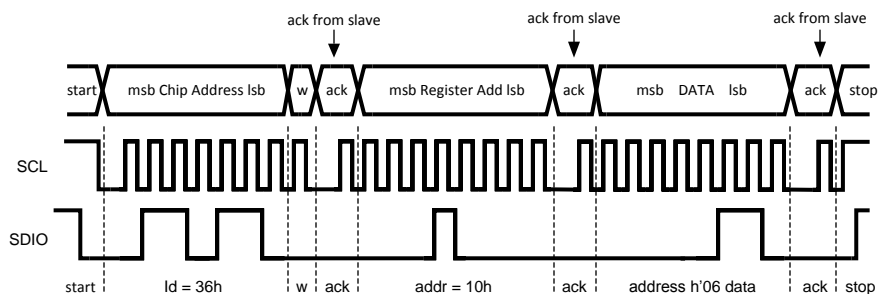

**Figure 14. Start and Stop Conditions**

### TRANSFERRING DATA

Every byte put on the SDIO line must be eight bits long, with the most significant bit (MSB) being transferred first. Each byte of data has to be followed by an acknowledge bit. The acknowledge related clock pulse is generated by the master. The master releases the SDIO line (HIGH) during the acknowledge clock pulse. The LM27964 pulls down the SDIO line during the 9th clock pulse, signifying an acknowledge. The LM27964 generates an acknowledge after each byte has been received.

After the START condition, the I<sup>2</sup>C master sends a chip address. This address is seven bits long followed by an eighth bit which is a data direction bit (R/W). The LM27964 address is 36h. For the eighth bit, a “0” indicates a WRITE and a “1” indicates a READ. The second byte selects the register to which the data will be written. The third byte contains data to write to the selected register.



(1) w = write (SDIO = "0", r = read (SDIO = "1"), ack = acknowledge (SDIO pulled down by either master or slave), rs = repeated start, id = chip address, 36h for LM27964

Figure 15. Write Cycle<sup>(1)</sup>

INTERNAL REGISTERS OF LM27964

Register	Internal Hex Address	Power On Value
General Purpose Register	10h	0000 0000
Bank A and Bank B Brightness Control Register	A0h	0000 0000
KEYPAD Brightness Control	B0h	0000 0000

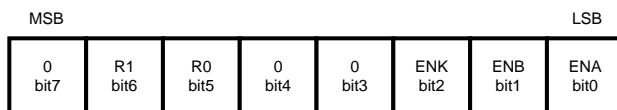

Figure 16. General Purpose Register Description  
Internal Hex Address: 10h

NOTE

ENA: Enables DxA LED drivers (Main Display)

ENB: Enables DxB LED drivers (Sub Display)

ENK: Enables Keypad Driver

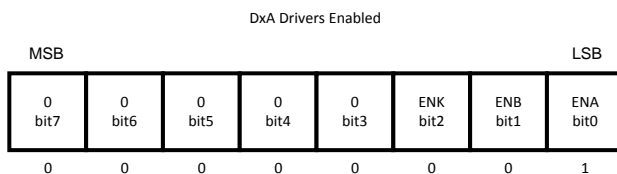
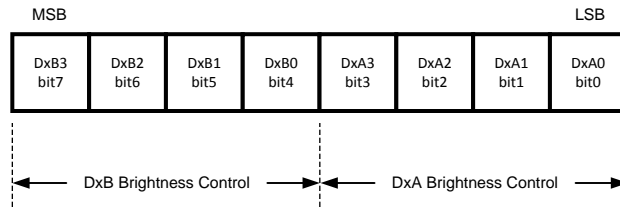

Figure 17. General Purpose Register Example



**Figure 18. Brightness Control Register Description**  
Internal Hex Address: A0h

**NOTE**

DxA3-DxA0: Register Sets Current Level Supplied to DxA LED drivers

DxB3-DxB0: Register Sets Current Level Supplied to DxB LED drivers

Full-Scale Current set externally by the following equation:

$$I_{Dxx} = 200 \times 1.25V / R_{SETx}$$

Brightness Level Segments = 1/16th of Fullscale

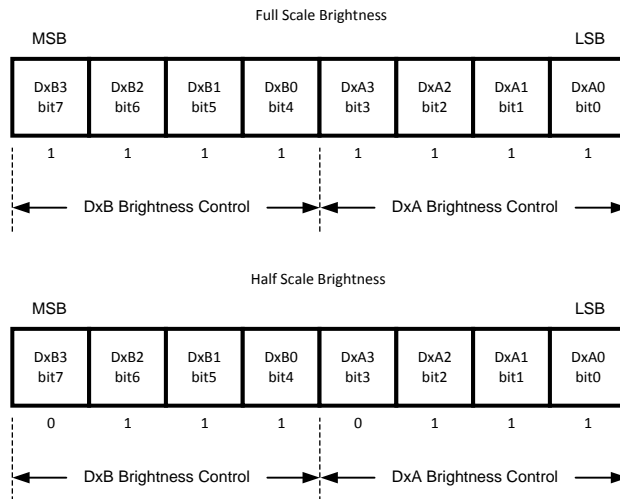

**Figure 19. Brightness Control Register Example**

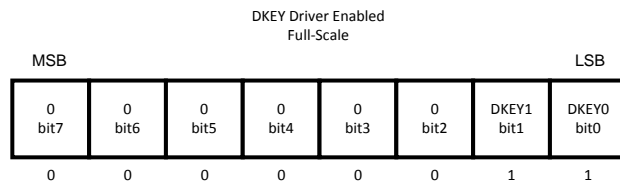

**Figure 20. Internal Hex Address: B0h**

**NOTE**

DKEY1-DKEY0: Sets Brightness for DKEY pin (KEYPAD Driver). 11=Fullscale

Bit 7 to Bit 2: Not Used

Full-Scale Current set externally by the following equation:

$$I_{DKEY} = 800 \times 1.25V / R_{SETx}$$

Brightness Level are= 100% (Fullscale), 70%, 40%, 20%

## APPLICATION INFORMATION

### SETTING LED CURRENT

The current through the LEDs connected to DxA, DxB and DKEY can be set to a desired level simply by connecting an appropriately sized resistor ( $R_{SETX}$ ) between the  $I_{SETX}$  pin of the LM27964 and GND. The DxA and DxB LED currents are proportional to the current that flows out of the  $I_{SETA}$  and  $I_{SETB}$  pins and are a factor of 200 times greater than the  $I_{SETA/B}$  currents. The DKEY current is proportional to the current that flows out of the  $I_{SETK}$  pin and is a factor of 800 times greater than the  $I_{SETK}$  current. The feedback loops of the internal amplifiers set the voltage of the  $I_{SETX}$  pins to 1.25V (typ.). Separate  $R_{SETX}$  resistor should be used on each  $I_{SETX}$  pin. The statements above are simplified in the equations below:

$$I_{DxA/B} = 200 \times (V_{ISET} / R_{SETA/B})$$

$$R_{SETA/B} = 200 \times (1.25V / I_{DxA/B})$$

$$I_{DKEY} = 800 \times (V_{ISET} / R_{SETK})$$

$$R_{SETK} = 800 \times (1.25V / I_{DKEY})$$

Once the desired  $R_{SETX}$  values have been chosen, the LM27964 has the ability to internally dim the LEDs by Pulse Width Modulating (PWM) the current. The PWM duty cycle is set through the I<sup>2</sup>C compatible interface. LEDs connected to BankA and BankB current sinks (DxA and DxB) can be dimmed to 16 different levels/duty-cycles (1/16th of full-scale to full-scale). The internal PWM frequency for BankA and BankB is a fixed 10kHz (LM27964SQ-I) or 23kHz (LM27964SQ-C) depending on the option.

The DKEY current sink uses an analog current scaling method to control LED brightness. The brightness levels are 100% (Fullscale), 70%, 40%, and 20%. When connecting multiple LEDs in parallel to the DKEY current sink, it is recommended that ballast resistors be placed in series with the LEDs. The ballast resistors help reduce the affect of LED forward voltage mismatch, and help equalize the diode currents. Ballast resistor values must be carefully chosen to ensure that the current source headroom voltage is sufficient to supply the desired current.

Please refer to the I<sup>2</sup>C Compatible Interface section of this datasheet for detailed instructions on how to adjust the brightness control registers.

### MAXIMUM OUTPUT CURRENT, MAXIMUM LED VOLTAGE, MINIMUM INPUT VOLTAGE

The LM27964 can drive 4 LEDs at 30mA each (BankA) and 12 keypad LEDs at 5mA each (60mA total at DKEY) from an input voltage as low as 3.2V, so long as the LEDs have a forward voltage of 3.6V or less (room temperature).

The statement above is a simple example of the LED drive capabilities of the LM27964. The statement contains the key application parameters that are required to validate an LED-drive design using the LM27964: LED current ( $I_{LEDx}$ ), number of active LEDs ( $N_x$ ), LED forward voltage ( $V_{LED}$ ), and minimum input voltage ( $V_{IN-MIN}$ ).

The equation below can be used to estimate the maximum output current capability of the LM27964:

$$I_{LED\_MAX} = [(1.5 \times V_{IN}) - V_{LED} - (I_{ADDITIONAL} \times R_{OUT})] / [(N_x \times R_{OUT}) + k_{HRx}] \quad (1)$$

$$I_{LED\_MAX} = [(1.5 \times V_{IN}) - V_{LED} - (I_{ADDITIONAL} \times 2.75\Omega)] / [(N_x \times 2.75\Omega) + k_{HRx}] \quad (2)$$

$I_{ADDITIONAL}$  is the additional current that could be delivered to the other LED banks.

**$R_{OUT}$**  – Output resistance. This parameter models the internal losses of the charge pump that result in voltage droop at the pump output  $P_{OUT}$ . Since the magnitude of the voltage droop is proportional to the total output current of the charge pump, the loss parameter is modeled as a resistance. The output resistance of the LM27964 is typically 2.75 $\Omega$  ( $V_{IN} = 3.6V$ ,  $T_A = 25^\circ C$ ). In equation form:

$$V_{POUT} = (1.5 \times V_{IN}) - [(N_A \times I_{LEDA} + N_B \times I_{LEDB} + N_K \times I_{LEDK}) \times R_{OUT}] \quad (3)$$

**$k_{HR}$**  – Headroom constant. This parameter models the minimum voltage required to be present across the current sources for them to regulate properly. This minimum voltage is proportional to the programmed LED current, so the constant has units of mV/mA. The typical  $k_{HR}$  of the LM27964 is 12mV/mA. In equation form:

$$(V_{POUT} - V_{LEDx}) > k_{HRx} \times I_{LEDx} \quad (4)$$

#### Typical Headroom Constant Values

$$k_{HRA} = 12\text{mV/mA}$$

$$k_{HRB} = 12\text{ mV/mA}$$

$$k_{HRK} = 3\text{ mV/mA}$$

The " $I_{LED-MAX}$ " Equation 1 is obtained from combining the  $R_{OUT}$  Equation 3 with the  $k_{HRx}$  Equation 4 and solving for  $I_{LEDx}$ . Maximum LED current is highly dependent on minimum input voltage and LED forward voltage. Output current capability can be increased by raising the minimum input voltage of the application, or by selecting an LED with a lower forward voltage. Excessive power dissipation may also limit output current capability of an application.

### Total Output Current Capability

The maximum output current that can be drawn from the LM27964 is 180mA. Each driver bank has a maximum allotted current per Dxx sink that must not be exceeded.

**Table 2. Driver Bank Maximum Allotted Current per Dxx Sink**

DRIVER TYPE	MAXIMUM Dxx CURRENT
DxA	30mA per DxA Pin
DxB	30mA per DxB Pin
DKEY	80mA

The 180mA load can be distributed in many different configurations. Special care must be taken when running the LM27964 at the maximum output current to ensure proper functionality.

### PARALLEL CONNECTED OUTPUTS

Outputs D1A-4A or D1B-D2B may be connected together to drive one or two LEDs at higher currents. In such a configuration, all four parallel current sinks (BankA) of equal value can drive a single LED. The LED current programmed for BankA should be chosen so that the current through each of the outputs is programmed to 25% of the total desired LED current. For example, if 60mA is the desired drive current for a single LED,  $R_{SETA}$  should be selected such that the current through each of the current sink inputs is 15mA. Similarly, if two LEDs are to be driven by pairing up the D1A-4A inputs (i.e D1A-2A, D3A-4A),  $R_{SETA}$  should be selected such that the current through each current sink input is 50% of the desired LED current. The same RSETx selection guidelines apply to BankB diodes.

Connecting the outputs in parallel does not affect internal operation of the LM27964 and has no impact on the Electrical Characteristics and limits previously presented. The available diode output current, maximum diode voltage, and all other specifications provided in the Electrical Characteristics table apply to this parallel output configuration, just as they do to the standard 4-LED application circuit.

Both BankA and BankB utilize LED forward voltage sensing circuitry on each Dxx pin to optimize the charge-pump gain for maximum efficiency. Due to the nature of the sensing circuitry, it is not recommended to leave any of the DxA or DxB pins unused if either diode bank is going to be used during normal operation. Leaving DxA and/or DxB pins unconnected will force the charge-pump into 3/2x mode over the entire  $V_{IN}$  range negating any efficiency gain that could be achieved by switching to 1x mode at higher input voltages.

Care must be taken when selecting the proper  $R_{SETx}$  value. The current on any Dxx pin must not exceed the maximum current rating for any given current sink pin.

### POWER EFFICIENCY

Efficiency of LED drivers is commonly taken to be the ratio of power consumed by the LEDs ( $P_{LED}$ ) to the power drawn at the input of the part ( $P_{IN}$ ). With a 1.5x/1x charge pump, the input current is equal to the charge pump gain times the output current (total LED current). The efficiency of the LM27964 can be predicted as follows:

$$P_{LEDTOTAL} = (V_{LEDA} \times N_A \times I_{LEDA}) + (V_{LEDB} \times N_B \times I_{LEDB}) + (V_{LEDK} \times N_K \times I_{LEDK}) \quad (5)$$

$$P_{IN} = V_{IN} \times I_{IN} \quad (6)$$

$$P_{IN} = V_{IN} \times (GAIN \times I_{LEDTOTAL} + I_Q) \quad (7)$$

$$E = (P_{LEDTOTAL} \div P_{IN}) \quad (8)$$

It is also worth noting that efficiency as defined here is in part dependent on LED voltage. Variation in LED voltage does not affect power consumed by the circuit and typically does not relate to the brightness of the LED. For an advanced analysis, it is recommended that power consumed by the circuit ( $V_{IN} \times I_{IN}$ ) be evaluated rather than power efficiency.

## POWER DISSIPATION

The power dissipation ( $P_{DISS}$ ) and junction temperature ( $T_J$ ) can be approximated with the equations below.  $P_{IN}$  is the power generated by the 1.5x/1x charge pump,  $P_{LED}$  is the power consumed by the LEDs,  $T_A$  is the ambient temperature, and  $\theta_{JA}$  is the junction-to-ambient thermal resistance for the WQFN-24 package.  $V_{IN}$  is the input voltage to the LM27964,  $V_{LED}$  is the nominal LED forward voltage,  $N$  is the number of LEDs and  $I_{LED}$  is the programmed LED current.

$$P_{DISS} = P_{IN} - P_{LEDA} - P_{LEDB} - P_{LEDK} \quad (9)$$

$$P_{DISS} = (GAIN \times V_{IN} \times I_{LEDA} + I_{LEDB} + I_{LEDK}) - (V_{LEDA} \times N_A \times I_{LEDA}) - (V_{LEDB} \times N_B \times I_{LEDB}) - (V_{LEDK} \times N_K \times I_{LEDK}) \quad (10)$$

$$T_J = T_A + (P_{DISS} \times \theta_{JA}) \quad (11)$$

The junction temperature rating takes precedence over the ambient temperature rating. The LM27964 may be operated outside the ambient temperature rating, so long as the junction temperature of the device does not exceed the maximum operating rating of 100°C. The maximum ambient temperature rating must be derated in applications where high power dissipation and/or poor thermal resistance causes the junction temperature to exceed 100°C.

## THERMAL PROTECTION

Internal thermal protection circuitry disables the LM27964 when the junction temperature exceeds 170°C (typ.). This feature protects the device from being damaged by high die temperatures that might otherwise result from excessive power dissipation. The device will recover and operate normally when the junction temperature falls below 165°C (typ.). It is important that the board layout provide good thermal conduction to keep the junction temperature within the specified operating ratings.

## CAPACITOR SELECTION

The LM27964 requires 4 external capacitors for proper operation ( $C_1 = C_2 = 1\mu\text{F}$ ,  $C_{IN} = C_{OUT} = 2.2\mu\text{F}$ ). Surface-mount multi-layer ceramic capacitors are recommended. These capacitors are small, inexpensive and have very low equivalent series resistance (ESR <20mΩ typ.). Tantalum capacitors, OS-CON capacitors, and aluminum electrolytic capacitors are not recommended for use with the LM27964 due to their high ESR, as compared to ceramic capacitors.

For most applications, ceramic capacitors with X7R or X5R temperature characteristic are preferred for use with the LM27964. These capacitors have tight capacitance tolerance (as good as ±10%) and hold their value over temperature (X7R: ±15% over -55°C to 125°C; X5R: ±15% over -55°C to 85°C).

Capacitors with Y5V or Z5U temperature characteristic are generally not recommended for use with the LM27964. Capacitors with these temperature characteristics typically have wide capacitance tolerance (+80%, -20%) and vary significantly over temperature (Y5V: +22%, -82% over -30°C to +85°C range; Z5U: +22%, -56% over +10°C to +85°C range). Under some conditions, a nominal 1μF Y5V or Z5U capacitor could have a capacitance of only 0.1μF. Such detrimental deviation is likely to cause Y5V and Z5U capacitors to fail to meet the minimum capacitance requirements of the LM27964.

The minimum voltage rating acceptable for all capacitors is 6.3V. The recommended voltage rating of the output capacitor is 10V to account for DC bias capacitance losses.

## PCB LAYOUT CONSIDERATIONS

The WQFN is a leadframe based Chip Scale Package (CSP) with very good thermal properties. This package has an exposed DAP (die attach pad) at the center of the package measuring 2.6mm x 2.5mm. The main advantage of this exposed DAP is to offer lower thermal resistance when it is soldered to the thermal land on the PCB. For PCB layout, TI highly recommends a 1:1 ratio between the package and the PCB thermal land. To further enhance thermal conductivity, the PCB thermal land may include vias to a ground plane. For more detailed instructions on mounting WQFN packages, see the TI AN-1187 Application Report ([SNOA401](#)).

### REVISION HISTORY

Changes from Revision C (May 2013) to Revision D	Page
• Changed layout of National Data Sheet to TI format .....	<a href="#">15</a>

**PACKAGING INFORMATION**

Orderable Device	Status (1)	Package Type	Package Drawing	Pins	Package Qty	Eco Plan (2)	Lead/Ball Finish (6)	MSL Peak Temp (3)	Op Temp (°C)	Device Marking (4/5)	Samples
LM27964SQ-A/NOPB	ACTIVE	WQFN	RTW	24	1000	Green (RoHS & no Sb/Br)	CU SN	Level-1-260C-UNLIM	-30 to 85	27964-A	<a href="#">Samples</a>

(1) The marketing status values are defined as follows:

**ACTIVE:** Product device recommended for new designs.

**LIFEBUY:** TI has announced that the device will be discontinued, and a lifetime-buy period is in effect.

**NRND:** Not recommended for new designs. Device is in production to support existing customers, but TI does not recommend using this part in a new design.

**PREVIEW:** Device has been announced but is not in production. Samples may or may not be available.

**OBSOLETE:** TI has discontinued the production of the device.

(2) **RoHS:** TI defines "RoHS" to mean semiconductor products that are compliant with the current EU RoHS requirements for all 10 RoHS substances, including the requirement that RoHS substance do not exceed 0.1% by weight in homogeneous materials. Where designed to be soldered at high temperatures, "RoHS" products are suitable for use in specified lead-free processes. TI may reference these types of products as "Pb-Free".

**RoHS Exempt:** TI defines "RoHS Exempt" to mean products that contain lead but are compliant with EU RoHS pursuant to a specific EU RoHS exemption.

**Green:** TI defines "Green" to mean the content of Chlorine (Cl) and Bromine (Br) based flame retardants meet JS709B low halogen requirements of <=1000ppm threshold. Antimony trioxide based flame retardants must also meet the <=1000ppm threshold requirement.

(3) MSL, Peak Temp. - The Moisture Sensitivity Level rating according to the JEDEC industry standard classifications, and peak solder temperature.

(4) There may be additional marking, which relates to the logo, the lot trace code information, or the environmental category on the device.

(5) Multiple Device Markings will be inside parentheses. Only one Device Marking contained in parentheses and separated by a "~" will appear on a device. If a line is indented then it is a continuation of the previous line and the two combined represent the entire Device Marking for that device.

(6) Lead/Ball Finish - Orderable Devices may have multiple material finish options. Finish options are separated by a vertical ruled line. Lead/Ball Finish values may wrap to two lines if the finish value exceeds the maximum column width.

**Important Information and Disclaimer:**The information provided on this page represents TI's knowledge and belief as of the date that it is provided. TI bases its knowledge and belief on information provided by third parties, and makes no representation or warranty as to the accuracy of such information. Efforts are underway to better integrate information from third parties. TI has taken and continues to take reasonable steps to provide representative and accurate information but may not have conducted destructive testing or chemical analysis on incoming materials and chemicals. TI and TI suppliers consider certain information to be proprietary, and thus CAS numbers and other limited information may not be available for release.

In no event shall TI's liability arising out of such information exceed the total purchase price of the TI part(s) at issue in this document sold by TI to Customer on an annual basis.

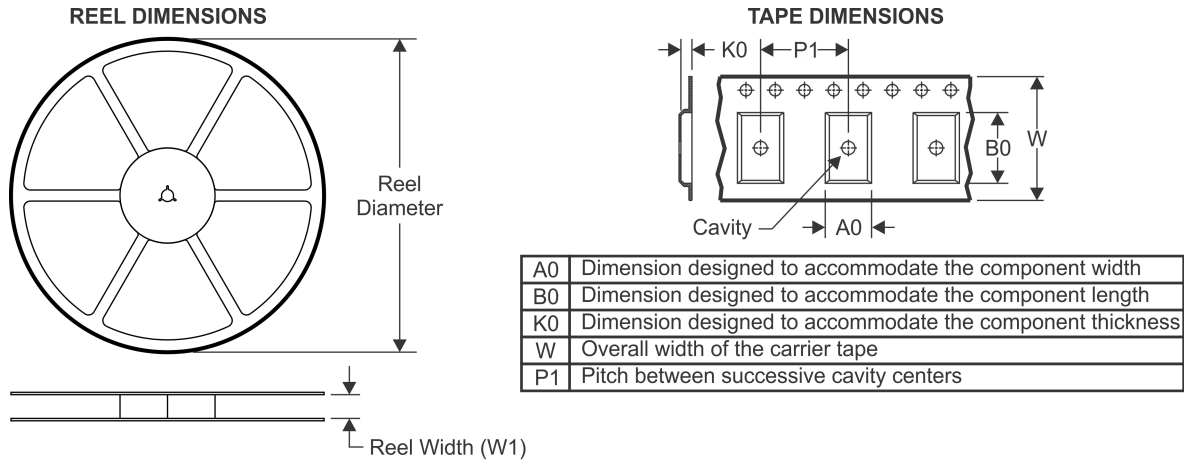
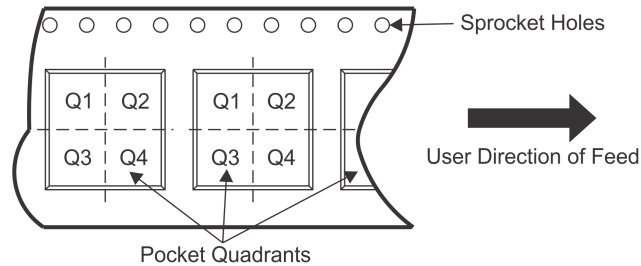
**TAPE AND REEL INFORMATION**

**QUADRANT ASSIGNMENTS FOR PIN 1 ORIENTATION IN TAPE**

\*All dimensions are nominal

Device	Package Type	Package Drawing	Pins	SPQ	Reel Diameter (mm)	Reel Width W1 (mm)	A0 (mm)	B0 (mm)	K0 (mm)	P1 (mm)	W (mm)	Pin1 Quadrant
LM27964SQ-A/NOPB	WQFN	RTW	24	1000	178.0	12.4	4.3	4.3	1.3	8.0	12.0	Q1

**TAPE AND REEL BOX DIMENSIONS**



\*All dimensions are nominal

Device	Package Type	Package Drawing	Pins	SPQ	Length (mm)	Width (mm)	Height (mm)
LM27964SQ-A/NOPB	WQFN	RTW	24	1000	210.0	185.0	35.0

RTW0024A

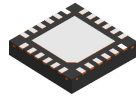

PACKAGE OUTLINE

WQFN - 0.8 mm max height

PLASTIC QUAD FLATPACK - NO LEAD

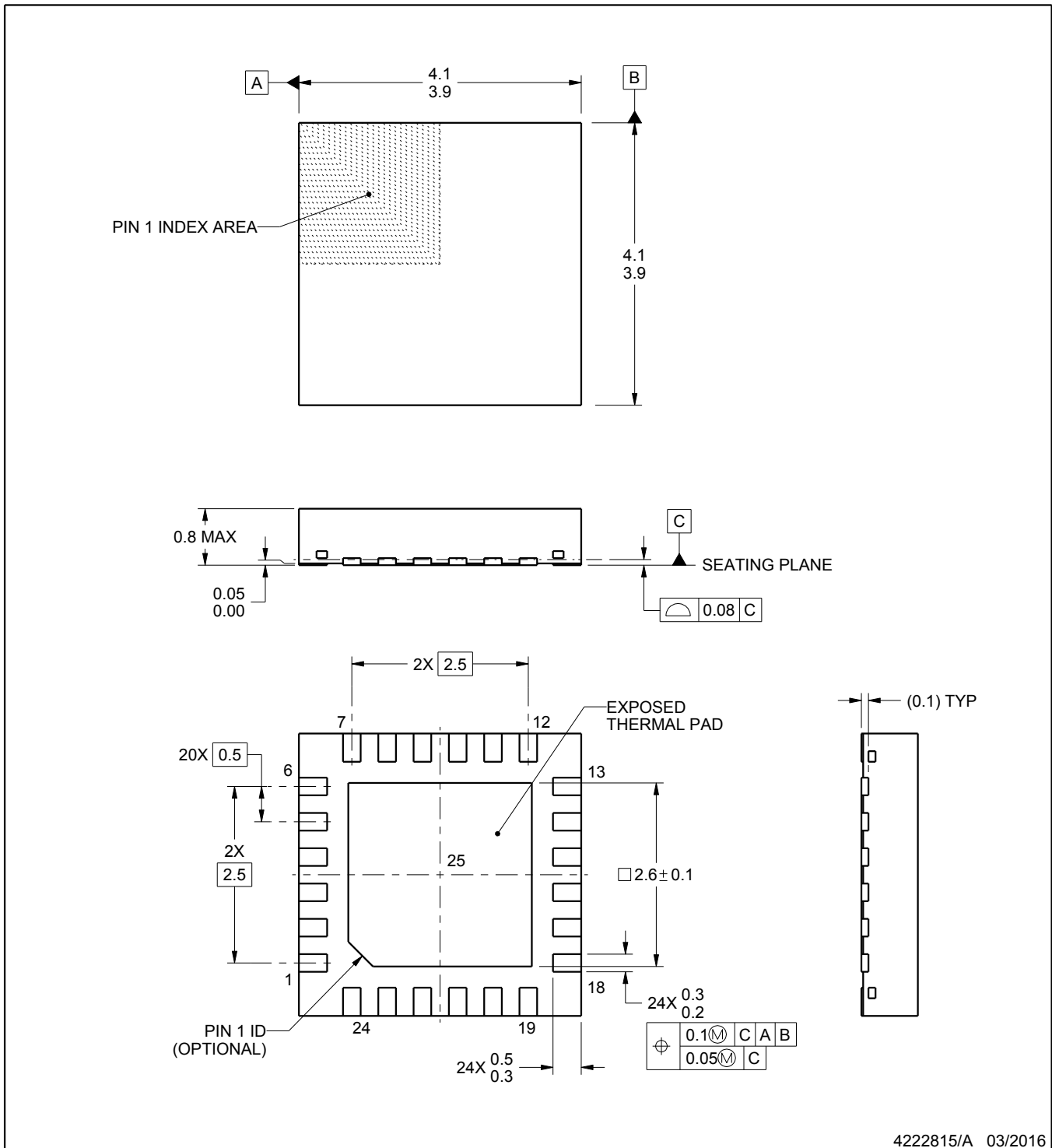

4222815/A 03/2016

NOTES:

1. All linear dimensions are in millimeters. Any dimensions in parenthesis are for reference only. Dimensioning and tolerancing per ASME Y14.5M.
2. This drawing is subject to change without notice.
3. The package thermal pad must be soldered to the printed circuit board for thermal and mechanical performance.

# EXAMPLE BOARD LAYOUT

RTW0024A

WQFN - 0.8 mm max height

PLASTIC QUAD FLATPACK - NO LEAD

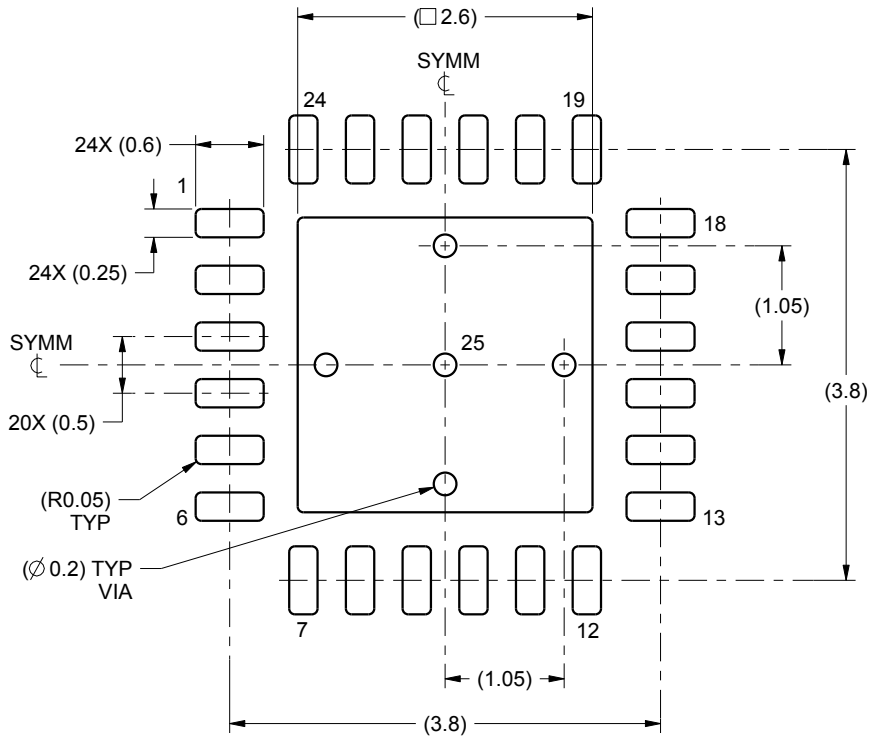

LAND PATTERN EXAMPLE  
SCALE:15X

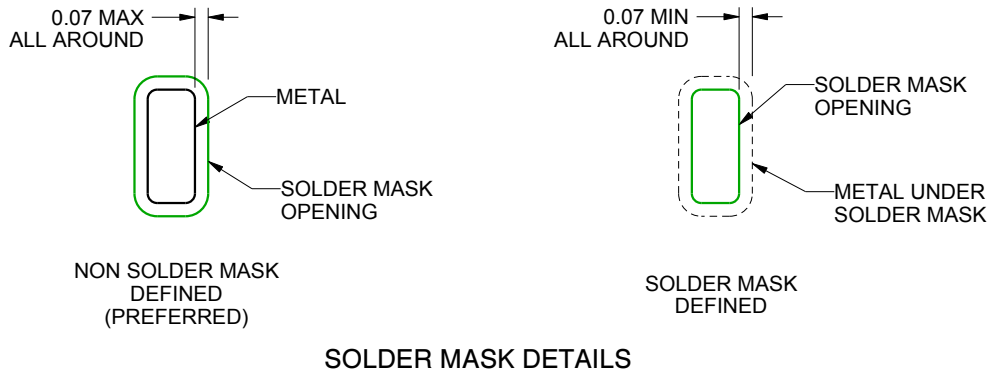

SOLDER MASK DETAILS

4222815/A 03/2016

NOTES: (continued)

4. This package is designed to be soldered to a thermal pad on the board. For more information, see Texas Instruments literature number SLUA271 ([www.ti.com/lit/sluea271](http://www.ti.com/lit/sluea271)).

# EXAMPLE STENCIL DESIGN

RTW0024A

WQFN - 0.8 mm max height

PLASTIC QUAD FLATPACK - NO LEAD

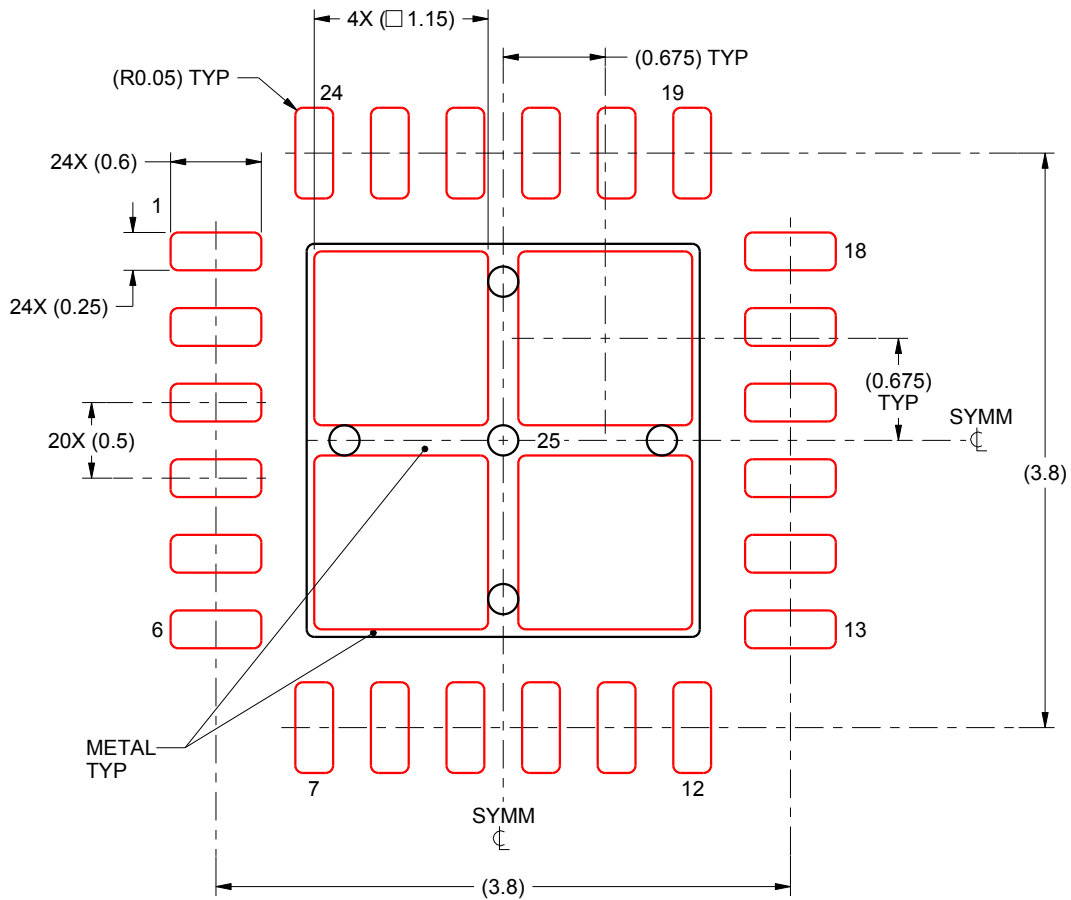

**SOLDER PASTE EXAMPLE**  
BASED ON 0.125 mm THICK STENCIL

EXPOSED PAD 25:  
78% PRINTED SOLDER COVERAGE BY AREA UNDER PACKAGE  
SCALE:20X

4222815/A 03/2016

NOTES: (continued)

5. Laser cutting apertures with trapezoidal walls and rounded corners may offer better paste release. IPC-7525 may have alternate design recommendations.

## IMPORTANT NOTICE AND DISCLAIMER

TI PROVIDES TECHNICAL AND RELIABILITY DATA (INCLUDING DATASHEETS), DESIGN RESOURCES (INCLUDING REFERENCE DESIGNS), APPLICATION OR OTHER DESIGN ADVICE, WEB TOOLS, SAFETY INFORMATION, AND OTHER RESOURCES "AS IS" AND WITH ALL FAULTS, AND DISCLAIMS ALL WARRANTIES, EXPRESS AND IMPLIED, INCLUDING WITHOUT LIMITATION ANY IMPLIED WARRANTIES OF MERCHANTABILITY, FITNESS FOR A PARTICULAR PURPOSE OR NON-INFRINGEMENT OF THIRD PARTY INTELLECTUAL PROPERTY RIGHTS.

These resources are intended for skilled developers designing with TI products. You are solely responsible for (1) selecting the appropriate TI products for your application, (2) designing, validating and testing your application, and (3) ensuring your application meets applicable standards, and any other safety, security, or other requirements. These resources are subject to change without notice. TI grants you permission to use these resources only for development of an application that uses the TI products described in the resource. Other reproduction and display of these resources is prohibited. No license is granted to any other TI intellectual property right or to any third party intellectual property right. TI disclaims responsibility for, and you will fully indemnify TI and its representatives against, any claims, damages, costs, losses, and liabilities arising out of your use of these resources.

TI's products are provided subject to TI's Terms of Sale ([www.ti.com/legal/termsofsale.html](http://www.ti.com/legal/termsofsale.html)) or other applicable terms available either on [ti.com](http://ti.com) or provided in conjunction with such TI products. TI's provision of these resources does not expand or otherwise alter TI's applicable warranties or warranty disclaimers for TI products.

Mailing Address: Texas Instruments, Post Office Box 655303, Dallas, Texas 75265  
Copyright © 2018, Texas Instruments Incorporated

## Looking for pricing, stock, or lifecycle information?

Click below to explore more details on WIN SOURCE:

 [View LM27964SQ-A/NOPB on WIN SOURCE](#)

 [Texas Instruments](#) Information

## Optimize Your Supply Chain with WIN SOURCE Solutions

-  Global Sourcing Solution
-  Obsolete Management
-  Cost Control Management
-  Shortage Management
-  Alternative Solution
-  Excess Inventory Management