



**THE DATASHEET OF
CM1443-08CP**



CM1443-08CP

8-Channel EMI Filter Array with ESD Protection

Features

- Eight Channels of EMI Filtering for Data Ports
- Pi-Style EMI Filters in a Capacitor-Resistor-Capacitor (C-R-C) Network
- ± 15 kV ESD Protection on Each Channel (IEC 61000-4-2 Level 4, Contact Discharge)
- ± 30 kV ESD Protection on Each Channel (HBM)
- Chip Scale Package (CSP) Features Extremely Low Lead Inductance for Optimum Filter and ESD Performance
- 20-Bump; 0.4 mm Pitch, 3.160 x 1.053 mm Footprint
- *OptiGuard*[™] Coating for Improved Reliability at Assembly
- These Devices are Pb-Free and are RoHS Compliant

Applications

- EMI Filtering and ESD Protection for Both Data and I/O Ports
- Wireless Handsets
- Handheld PCs / PDAs
- MP3 Players
- Notebooks
- Desktop PCs

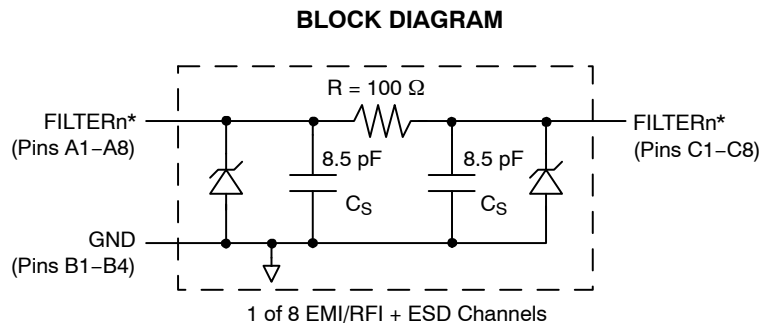

*See Package/Pinout Diagrams for expanded pin information.



ON Semiconductor[®]

<http://onsemi.com>

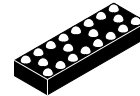

WLCSP20
CP SUFFIX
CASE 567BU

MARKING DIAGRAM

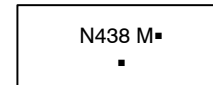

N438 = CM1443-08CP
M = Date Code
▪ = Pb-Free Package
(Note: Microdot may be in either location)

ORDERING INFORMATION

Device	Package	Shipping [†]
CM1443-08CP	CSP-20 (Pb-Free)	3500/Tape & Reel

[†]For information on tape and reel specifications, including part orientation and tape sizes, please refer to our Tape and Reel Packaging Specification Brochure, BRD8011/D.

CM1443-08CP

PACKAGE / PINOUT DIAGRAMS

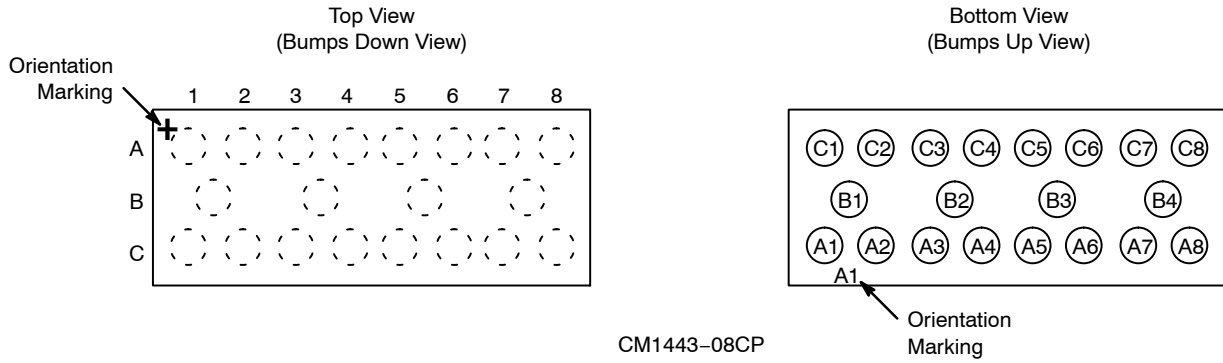

CM1443-08CP

Table 1. PIN DESCRIPTIONS

Pins	Name	Description	Pins	Name	Description
A1	FILTER1	Filter Channel 1	C1	FILTER1	Filter Channel 1
A2	FILTER2	Filter Channel 2	C2	FILTER2	Filter Channel 2
A3	FILTER3	Filter Channel 3	C3	FILTER3	Filter Channel 3
A4	FILTER4	Filter Channel 4	C4	FILTER4	Filter Channel 4
A5	FILTER5	Filter Channel 5	C5	FILTER5	Filter Channel 5
A6	FILTER6	Filter Channel 6	C6	FILTER6	Filter Channel 6
A7	FILTER7	Filter Channel 7	C7	FILTER7	Filter Channel 7
A8	FILTER8	Filter Channel 8	C8	FILTER8	Filter Channel 8
B1-B4	GND	Device Ground			

SPECIFICATIONS

Table 2. ABSOLUTE MAXIMUM RATINGS

Parameter	Rating	Units
Storage Temperature Range	-65 to +150	°C
DC Power per Resistor	100	mW
DC Package Power Rating	600	mW

Stresses exceeding Maximum Ratings may damage the device. Maximum Ratings are stress ratings only. Functional operation above the Recommended Operating Conditions is not implied. Extended exposure to stresses above the Recommended Operating Conditions may affect device reliability.

Table 3. STANDARD OPERATING CONDITIONS

Parameter	Rating	Units
Operating Temperature Range	-40 to +85	°C

CM1443-08CP

Table 4. ELECTRICAL OPERATING CHARACTERISTICS (Note 1)

Symbol	Parameter	Conditions	Min	Typ	Max	Units
R	Resistance		80	100	120	Ω
C _T	Total Capacitance	At 2.5 V DC	14	17	21	pF
C _S	Single Capacitor	At 2.5 V DC		8.5		pF
TCR	Temperature Coefficient of Resistance			1200		ppm/°C
TCC	Temperature Coefficient of Capacitance	At 2.5 V DC		-300		ppm/°C
V _{DIODE}	Diode Voltage (reverse bias)	I _{DIODE} = 10 μ A	5.5			V
I _{LEAK}	Diode Leakage Current (reverse bias)	V _{DIODE} = 3.3 V		0.1	1.0	μ A
V _{SIG}	Signal Voltage Positive Clamp Negative Clamp	I _{LOAD} = 10 mA	5.6 -1.5	6.8 -0.8	9.0 -0.4	V
V _{ESD}	In-system ESD Withstand Voltage a) Human Body Model, MIL-STD-883, Method 3015 b) Contact Discharge per IEC 61000-4-2 Level 4	(Notes 2 and 4)	\pm 30 \pm 15			kV
V _{CL}	Clamping Voltage during ESD Discharge MIL-STD-883 (Method 3015), 8 kV Positive Transients Negative Transients	(Notes 2, 3 and 4)		+10 -5		V
f _C	Cut-off Frequency Z _{SOURCE} = 50 Ω , Z _{LOAD} = 50 Ω	R = 100 Ω , C _S = 8.5 pF		220		MHz

1. T_A = 25°C unless otherwise specified.
2. ESD applied to input and output pins with respect to GND, one at a time.
3. Clamping voltage is measured at the opposite side of the EMI filter to the ESD pin. For example, if ESD is applied to Pin A1, then clamping voltage is measured at Pin C1.
4. Unused pins are left open.

APPLICATION INFORMATION

Refer to Application Note “The Chip Scale Package”, for a detailed description of Chip Scale Packages offered by ON Semiconductor.

PERFORMANCE INFORMATION

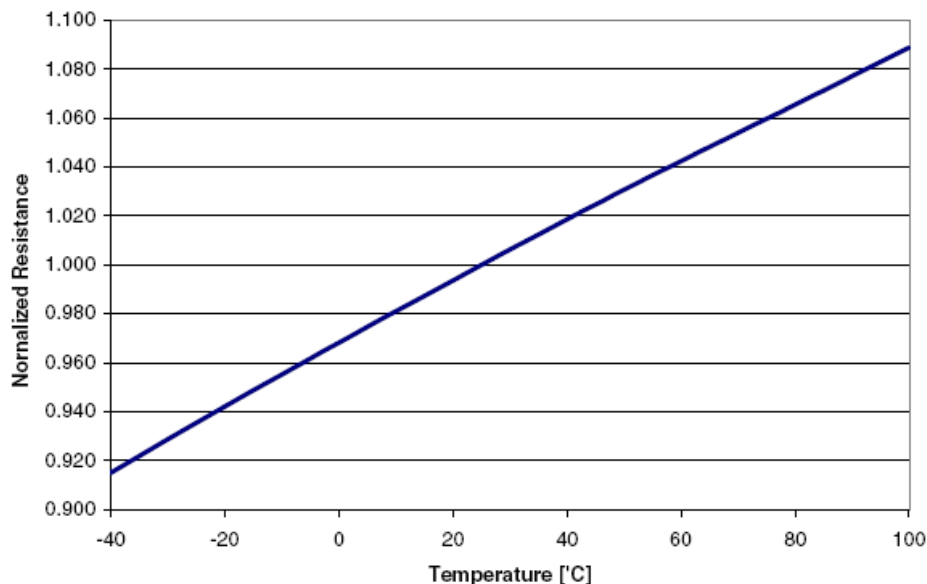

Figure 1. Resistance vs. Temperature (normalized to resistance at 25°C)

CM1443-08CP

PERFORMANCE INFORMATION (Cont'd)

Typical Filter Performance ($T_A = 25^\circ\text{C}$, DC Bias = 0 V, 50 Ω Environment)

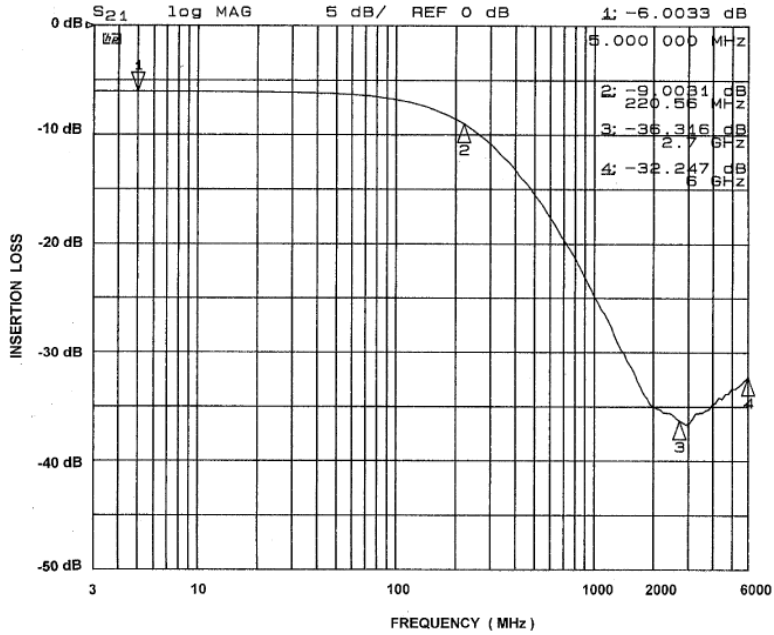

Figure 2. Insertion Loss vs. Frequency (A1-C1 to GND B1)

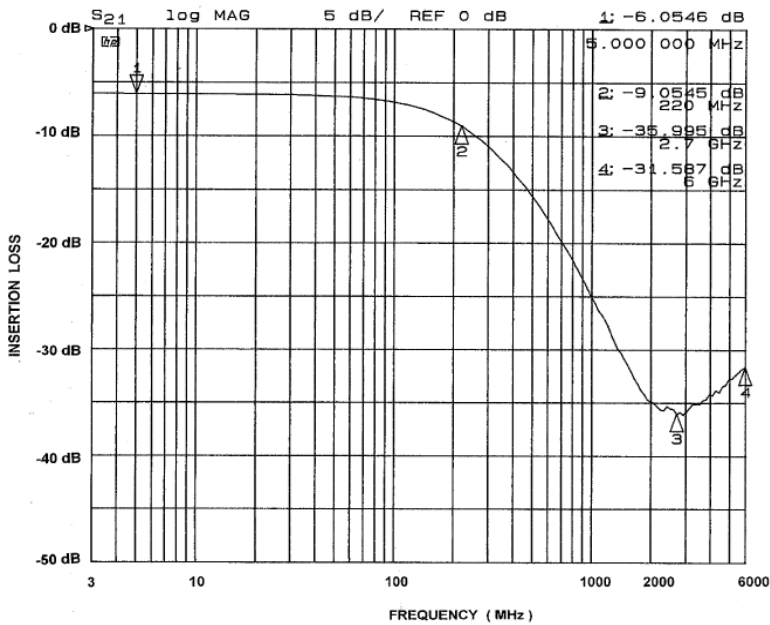

Figure 3. Insertion Loss vs. Frequency (A2-C2 to GND B1)

CM1443-08CP

PERFORMANCE INFORMATION (Cont'd)

Typical Filter Performance ($T_A = 25^\circ\text{C}$, DC Bias = 0 V, 50 Ω Environment)

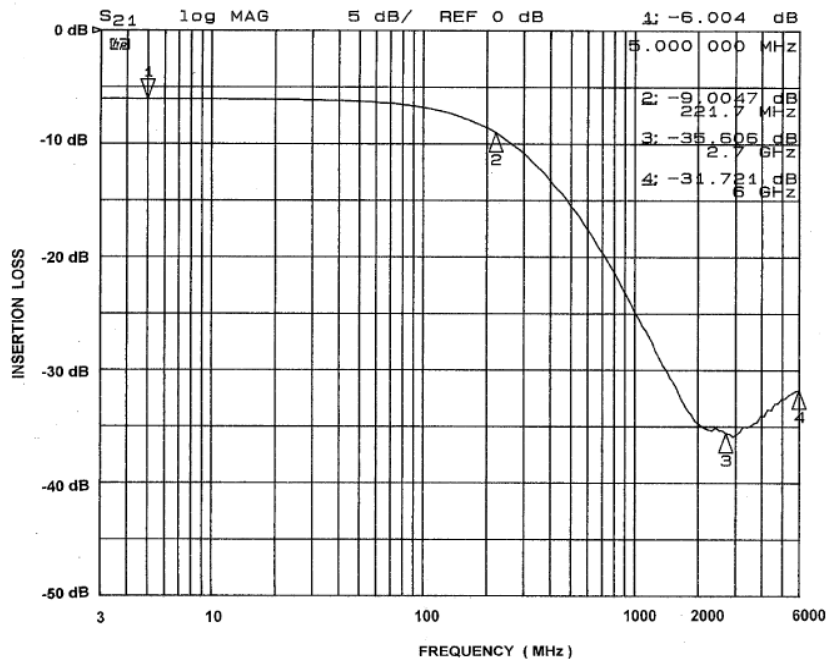

Figure 4. Insertion Loss vs. Frequency (A3-C3 to GND B2)

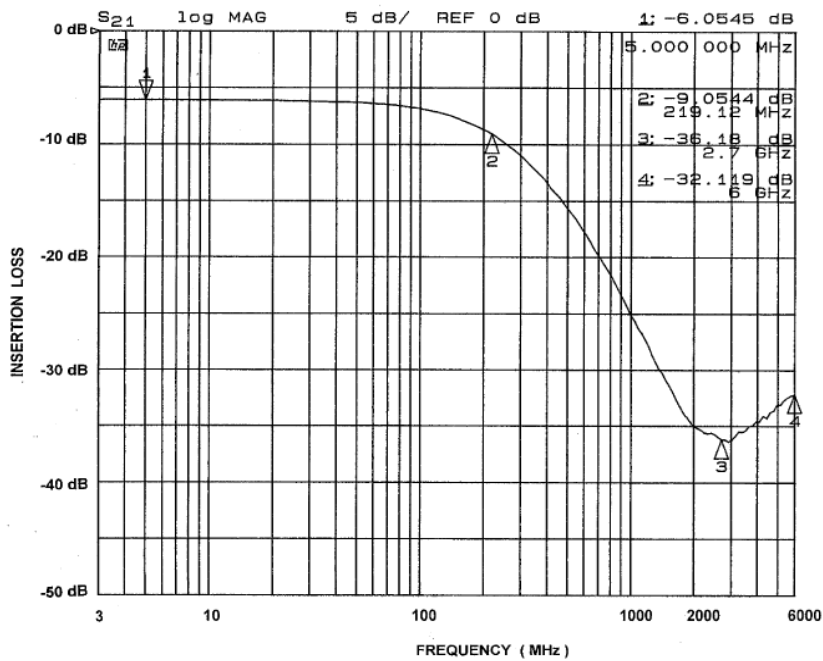

Figure 5. Insertion Loss vs. Frequency (A4-C4 to GND B2)

CM1443-08CP

PERFORMANCE INFORMATION (Cont'd)

Typical Filter Performance ($T_A = 25^\circ\text{C}$, DC Bias = 0 V, 50 Ω Environment)

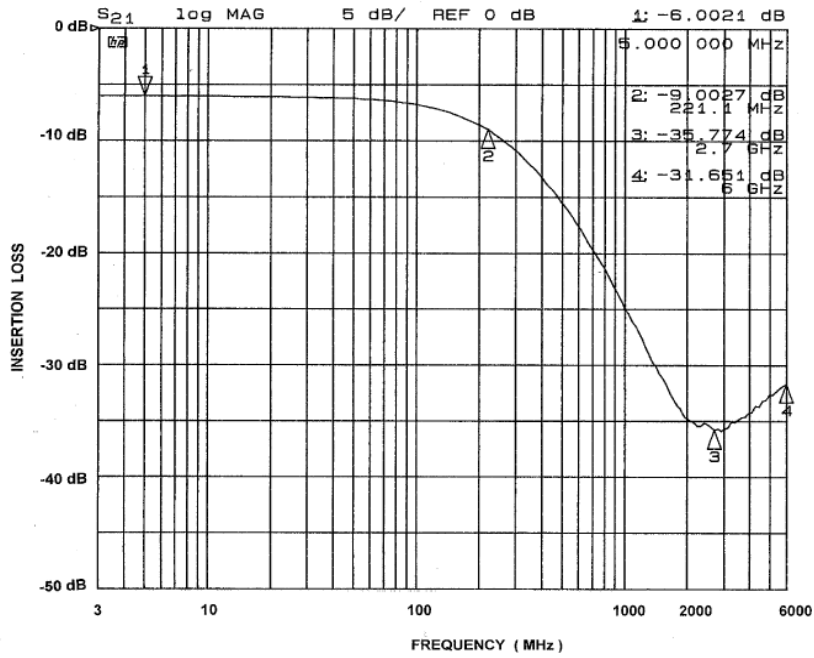

Figure 6. Insertion Loss vs. Frequency (A5-C5 to GND B3)

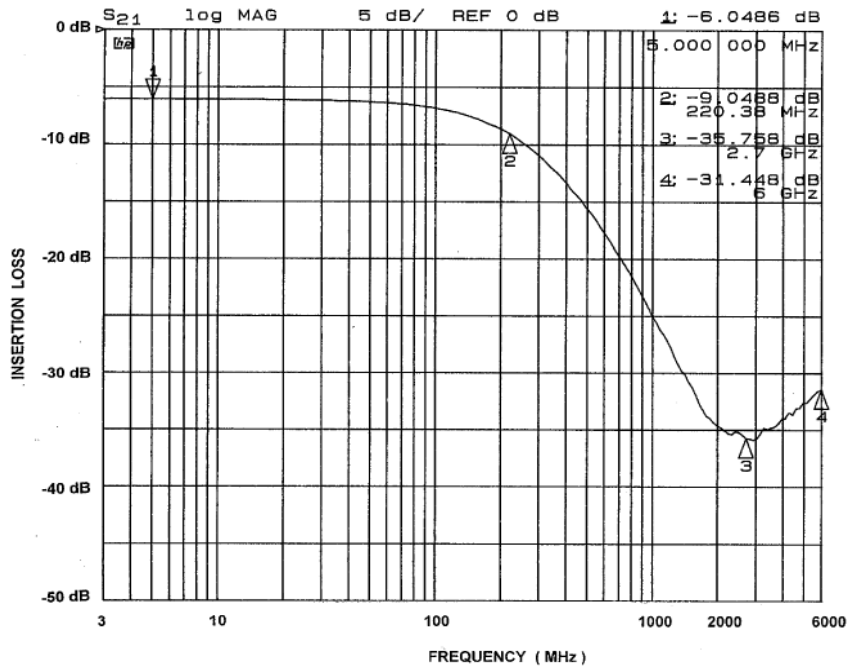

Figure 7. Insertion Loss vs. Frequency (A6-C6 to GND B3)

CM1443-08CP

PERFORMANCE INFORMATION (Cont'd)

Typical Filter Performance ($T_A = 25^\circ\text{C}$, DC Bias = 0 V, 50 Ω Environment)

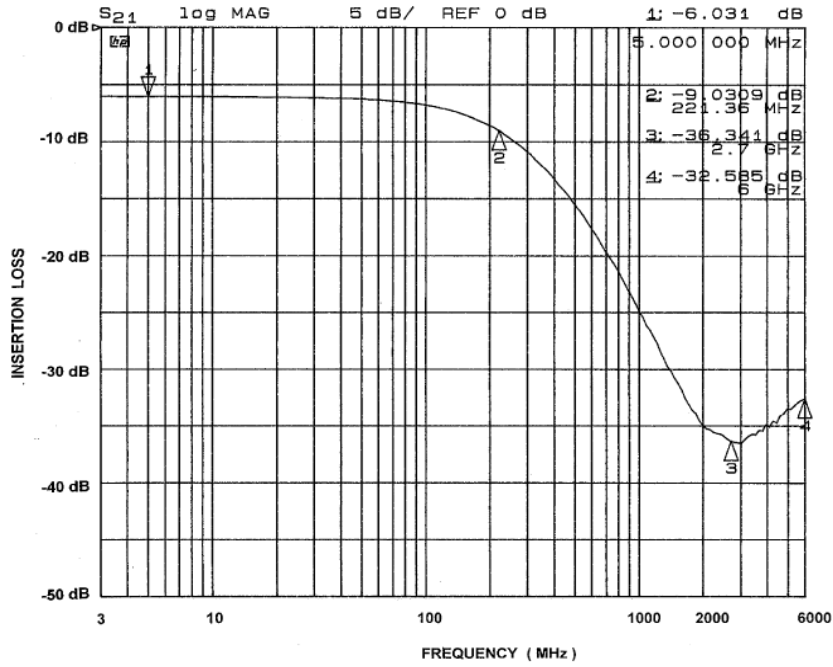

Figure 8. Insertion Loss vs. Frequency (A7-C7 to GND B4)

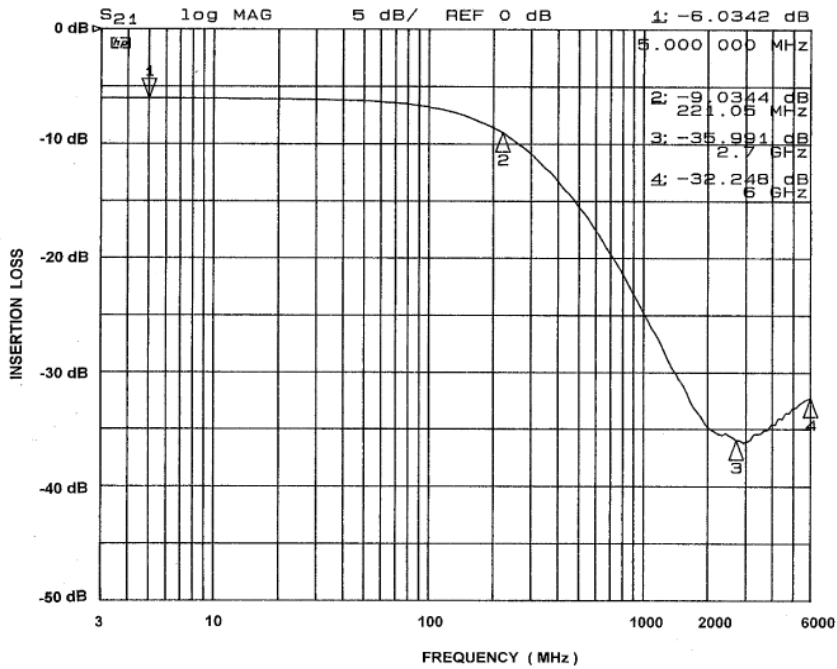

Figure 9. Insertion Loss vs. Frequency (A8-C8 to GND B4)

CM1443-08CP

PERFORMANCE INFORMATION (Cont'd)

Typical Filter Performance ($T_A = 25^\circ\text{C}$, DC Bias = 0 V, 50 Ω Environment)

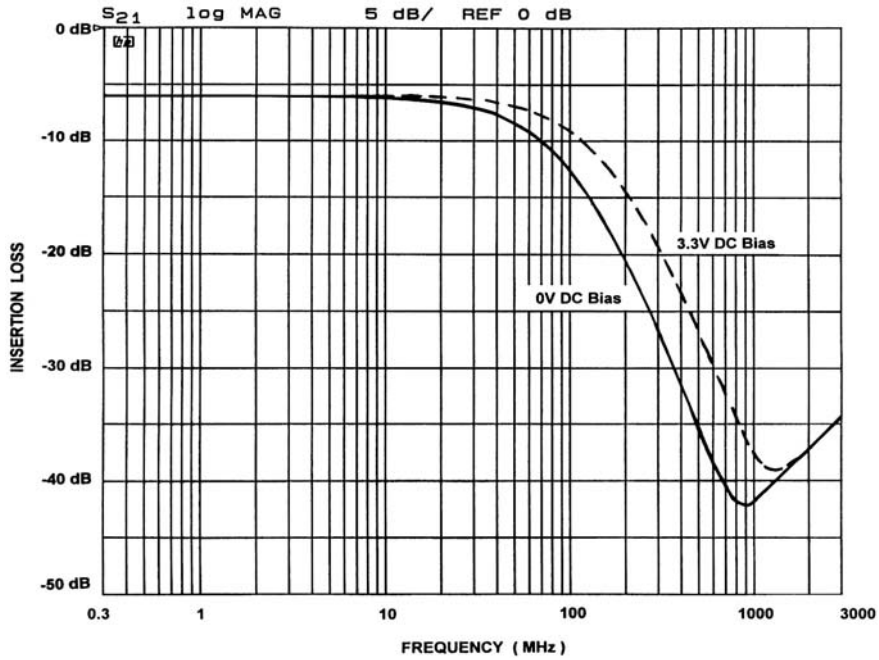

Figure 10. Comparison of Filter Response Curves for CM1443 vs. DC Bias

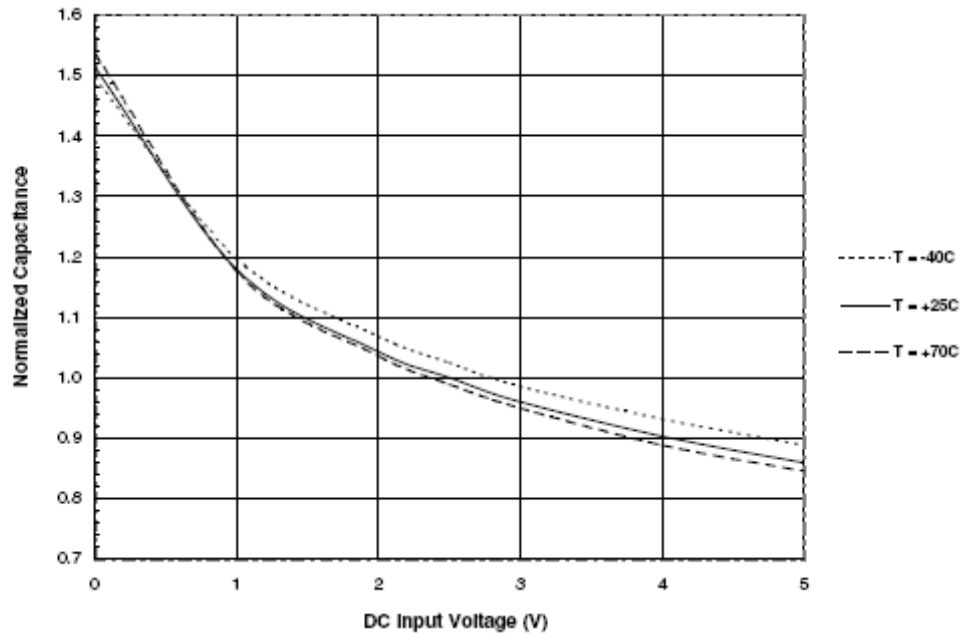
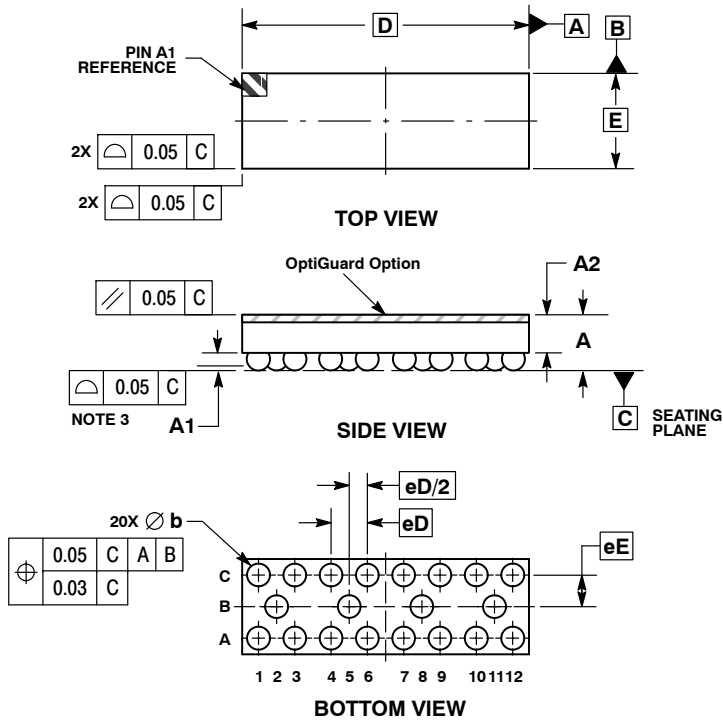

Figure 11. Filter Capacitance vs. Input Voltage over Temperature (normalized to capacitance at 2.5 VDC and 25°C)

CM1443-08CP

PACKAGE DIMENSIONS

WLCSP20, 3.16x1.05
CASE 567BU-01
ISSUE O



NOTES:

1. DIMENSIONING AND TOLERANCING PER ASME Y14.5M, 1994.
2. CONTROLLING DIMENSION: MILLIMETERS.
3. COPLANARITY APPLIES TO SPHERICAL CROWNS OF SOLDER BALLS.

DIM	MILLIMETERS	
	MIN	MAX
A	0.54	0.69
A1	0.17	0.24
A2	0.42 REF	
b	0.24	0.29
D	3.16 BSC	
E	1.05 BSC	
eD	0.400 BSC	
eE	0.347 BSC	

RECOMMENDED SOLDERING FOOTPRINT*

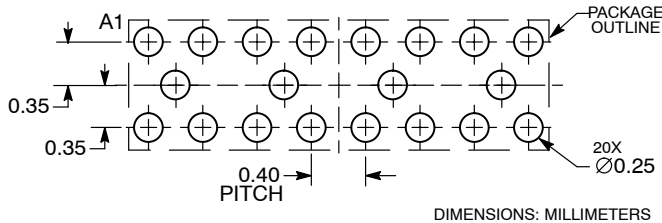

*For additional information on our Pb-Free strategy and soldering details, please download the ON Semiconductor Soldering and Mounting Techniques Reference Manual, SOLDERRM/D.

OptiGuard™ is a trademark of Semiconductor Components Industries, LLC.

ON Semiconductor and are registered trademarks of Semiconductor Components Industries, LLC (SCILLC). SCILLC reserves the right to make changes without further notice to any products herein. SCILLC makes no warranty, representation or guarantee regarding the suitability of its products for any particular purpose, nor does SCILLC assume any liability arising out of the application or use of any product or circuit, and specifically disclaims any and all liability, including without limitation special, consequential or incidental damages. "Typical" parameters which may be provided in SCILLC data sheets and/or specifications can and do vary in different applications and actual performance may vary over time. All operating parameters, including "Typicals" must be validated for each customer application by customer's technical experts. SCILLC does not convey any license under its patent rights nor the rights of others. SCILLC products are not designed, intended, or authorized for use as components in systems intended for surgical implant into the body, or other applications intended to support or sustain life, or for any other application in which the failure of the SCILLC product could create a situation where personal injury or death may occur. Should Buyer purchase or use SCILLC products for any such unintended or unauthorized application, Buyer shall indemnify and hold SCILLC and its officers, employees, subsidiaries, affiliates, and distributors harmless against all claims, costs, damages, and expenses, and reasonable attorney fees arising out of, directly or indirectly, any claim of personal injury or death associated with such unintended or unauthorized use, even if such claim alleges that SCILLC was negligent regarding the design or manufacture of the part. SCILLC is an Equal Opportunity/Affirmative Action Employer. This literature is subject to all applicable copyright laws and is not for resale in any manner.

PUBLICATION ORDERING INFORMATION

LITERATURE FULFILLMENT:
Literature Distribution Center for ON Semiconductor
P.O. Box 5163, Denver, Colorado 80217 USA
Phone: 303-675-2175 or 800-344-3860 Toll Free USA/Canada
Fax: 303-675-2176 or 800-344-3867 Toll Free USA/Canada
Email: orderlit@onsemi.com

N. American Technical Support: 800-282-9855 Toll Free USA/Canada
Europe, Middle East and Africa Technical Support:
Phone: 421 33 790 2910
Japan Customer Focus Center
Phone: 81-3-5773-3850

ON Semiconductor Website: www.onsemi.com
Order Literature: <http://www.onsemi.com/orderlit>
For additional information, please contact your local Sales Representative

Looking for pricing, stock, or lifecycle information?

Click below to explore more details on WIN SOURCE:

- ⊖ [View CM1443-08CP](#) on WIN SOURCE
- ⊖ [ON Semiconductor](#) Information

Optimize Your Supply Chain with WIN SOURCE Solutions

- ✓ Global Sourcing Solution
- ✓ Obsolete Management
- ✓ Cost Control Management
- ✓ Shortage Management
- ✓ Alternative Solution
- ✓ Excess Inventory Management