





THE DATASHEET OF KMB14F



SPECIFICATION SHEET

SPECIFICATION SHEET NO.	N0626-MBFKMB14FS1004
DATE	June 26, 2021
REVISION	A1
DESCRIPTION	SMD Schottky Bridge Rectifier, MBF series, KMB14F Type, 4 Pins, Reverse Voltage 40V Max. Forward Current 1.0A Max. Operating Temp. Range -55°C ~+125°C, Package in Tape/Reel, 5000pcs/Reel RoHS/RoHS III compliant
CUSTOMER	
CUSTOMER PART NUMBER	
CROSS REF. PART NUMBER	
ORIGINAL PART NUMBER	MDD KMB14F
PART CODE	MBFKMB14FS1004

VENDOR APPROVE			
Issued/Checked/Approved			
DATE: June 26, 2021			

CUSTOMER APPROVE	
DATE:	

SMD BRIDGE RECTIFIER MBF SERIES



MAIN FEATURE

- Surge overload rating: 30A peak
- Low leakage
- Reliable low cost construction utilizing molded
- Plastic material – UL flammability 94V-0

APPLICATION

- For SMD application

RFQ

[Request For Quotation](#)

PART CODE GUIDE

MBF	KMB14F	S	1004
1	2	3	4

- 1) **MBF**: SMD Schottky Bridge Rectifier, MBF series
- 2) **KMB14F**: Type code for original part number KMB14F
- 3) **S**: Package code, Tape/reel, 5000pcs/reel.
- 4) **1004**: Specification code for Reverse Voltage 40V Max. Forward Current 1.0A Max.

MORE ITEMS AVAILABLE

MBFKMB14FS1004	MBFKMB16FS1006	MBFKMB18FS1008	MBFKMB110FS110	MBFKMB115FS115
MBFKMB120FS120				

SMD BRIDGE RECTIFIER MBF SERIES

DIMENSION (Unit: Inch/mm)

Image for reference

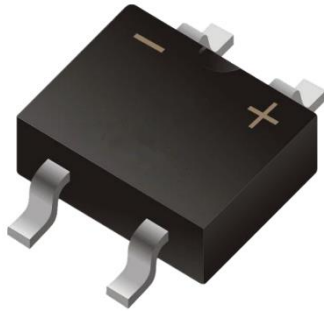

Marking: KMB14F

MBF

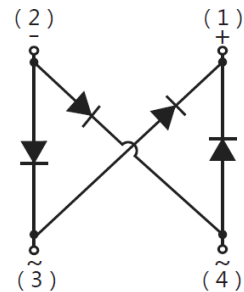
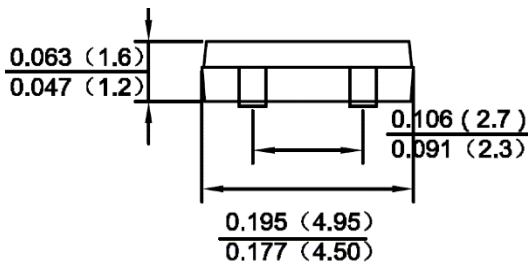
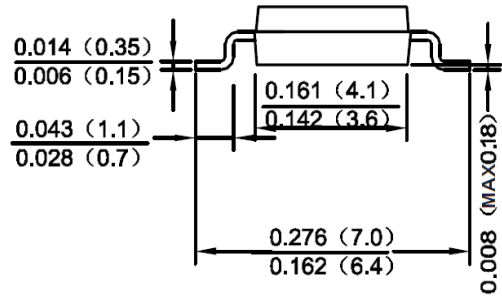
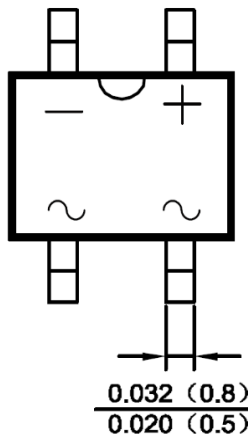

Recommend Pad Layout

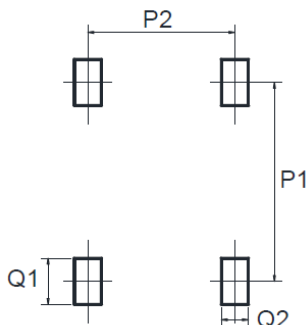

Symbol	Min. (Inch)	Min. (mm)
P1	0.236	6.00
P2	0.094	2.40
Q1	0.072	1.84
Q2	0.047	1.20

SMD BRIDGE RECTIFIER MBF SERIES
MECHANICAL DATA

Case	Terminals	Polarity	Mounting Position	Weight per piece
JEDEC MBF molded plastic body	Solder plated, Solderable per MIL-STD-750, Method 2026	Polarity symbol marking on case	Any	0.0026 Ounce, 0.075 grams

MAX. RATING & CHARACTERISTICS

Parameter	SYMBOLS	VALUE			UNITS
		Min.	Typical	Max.	
Repetitive peak reverse voltage	V _{RRM}			40	Volts
RMS voltage	V _{RMS}			28	Volts
DC blocking voltage	V _{DC}			40	Volts
Average forward output rectified current at T _c = 30°C, Aluminum Substrate	I _{AV}			1.0	A
Peak forward surge current 8.3ms single half sine-wave superimposed on rated load (JEDEC Method)	I _{FSM}		30		A
Instantaneous forward voltage at 1A	V _F			0.55	Volts
DC reverse current at rated DC blocking voltage	I _R			0.3	μA
				10	
Junction capacitance	C _J		110		pF
Thermal resistance (Note 2)	R _{QJA}		100		°C/W
Operating junction temperature range	T _J	-55		+125	
Storage temperature range	T _{STG}	-55		+150	°C

Note

- Ratings at 25 C ambient temperature unless otherwise specified. Single phase half-wave 60Hz, resistive or inductive load, for capacitive load current derate by 20%.
- Thermal resistance from junction to ambient and from junction to lead PCB mounted on 02"*0.2" copper pad areas.

SMD BRIDGE RECTIFIER MBF SERIES

RELIABILITY

Number	Experiment Items	Experiment Method And Conditions	Reference Documents
1	Solder Resistance Test	Test 260°C± 5°C for 10 ± 2 sec. Immerse body into solder 1/16" ± 1/32"	MIL-STD-750D METHOD-2031.2
2	Solderability Test	230°C ±5°C for 5 sec.	MIL-STD-750D METHOD-2026.1 0
3	Pull Test	1 kg in axial lead direction for 10 sec.	MIL-STD-750D METHOD-2036.4
4	Bend Test	0.5Kg Weight Applied To Each Lead, Bending Arcs 90 °C ± 5 °C For 3 Times	MIL-STD-750D METHOD-2036.4
5	High Temperature Reverse Bias Test	TA=100°C for 1000 Hours at VR=80% Rated VR	MIL-STD-750D METHOD-1038.4
6	Forward Operation Life Test	TA=25°C Rated Average Rectified Current	MIL-STD-750D METHOD-1027.3
7	Intermittent Operation Life Test	On state: 5 min with rated IRMS Power Off state: 5 min with Cool Forced Air. On and off for 1000 cycles.	MIL-STD-750D METHOD-1036.3
8	Pressure Cooker Test	15 PSIG, TA=121°C, 4 hours	MIL-S-19500 APPENIOXC
9	Temperature Cycling Test	-55°C~+125°C; 30 Minutes For Dwelled Time 5 minutes for transferred time. Total: 10 cycles.	MIL-STD-750D METHOD-1051.7
10	Thermal Shock Test	0°C for 5 minutes., 100°C for 5minutes, Total: 10 cycles	MIL-STD-750D METHOD-1056.7
11	Forward Surge Test	8.3ms Single Sale Sine-wave One Surge.	MIL-STD-750D METHOD-4066.4
12	Humidity Test	TA=65°C, RH=98% for 1000 hours.	MIL-STD-750D METHOD-1021.3
13	High Temperature Storage life Test	150°C for 1000 Hours	MIL-STD-750D METHOD-1031.5

SUGGESTED REFLOW PROFILE (For Reference Only)

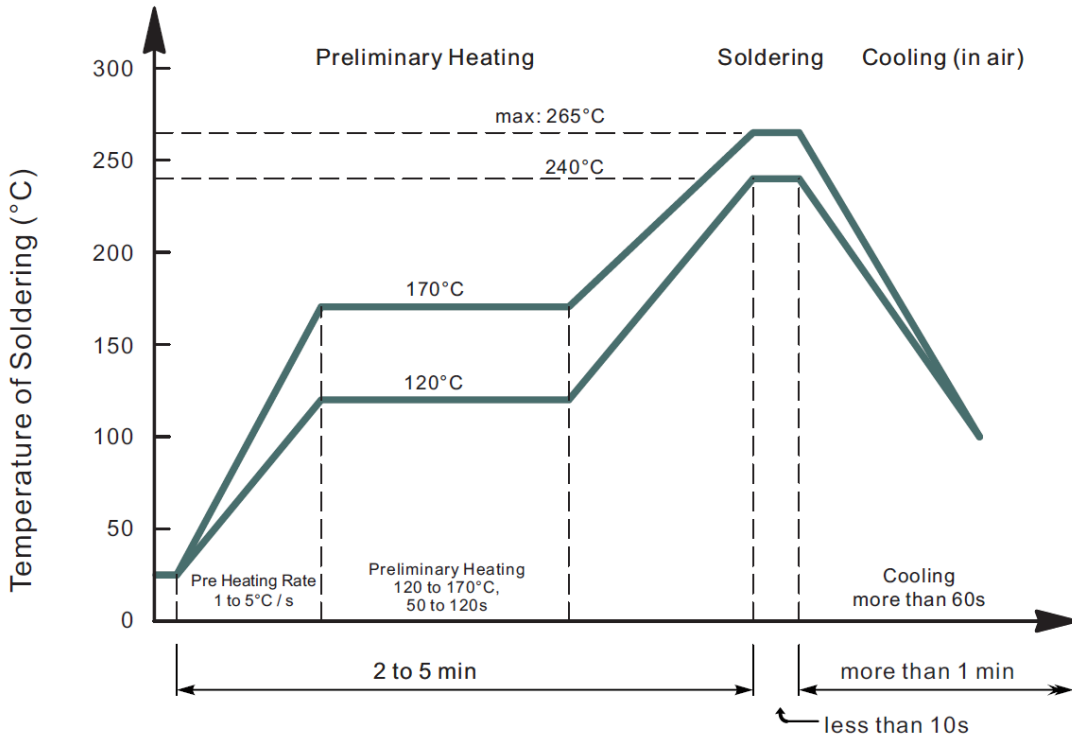

- Recommended peak temperature is over 245°C, If peak temperature is below 245 °C, you may adjust the following parameters; time length of peak temperature (longer), time length of soldering (longer), thickness of solder paste (thicker)
- Welding shall not exceed 2 times
- Remark: lead free solder paste (96.5 sn/3.0 Ag/0.5Cu)

RATINGS AND CHARACTERISTIC CURVES (For Reference Only)

Fig.1 Forward Current Derating Curve

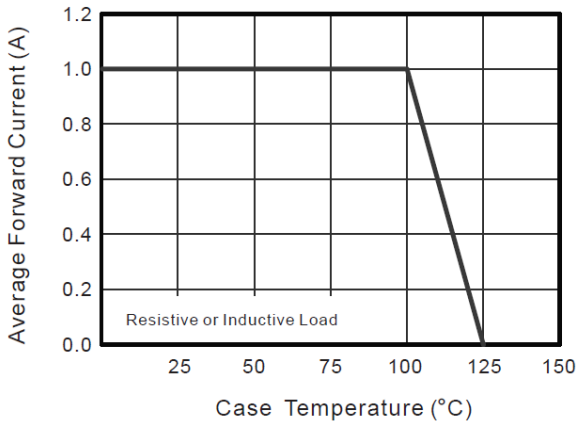

Fig.2 Typical Reverse Characteristics

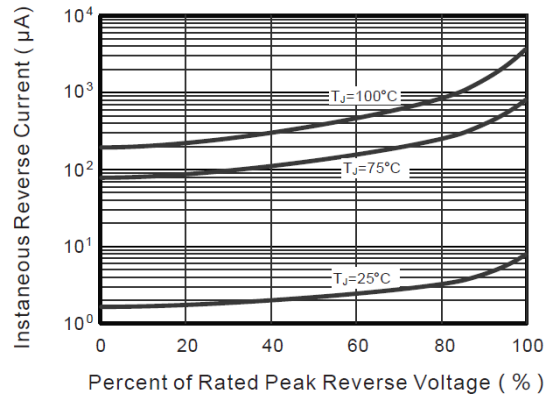

Fig.3 Typical Forward Characteristic

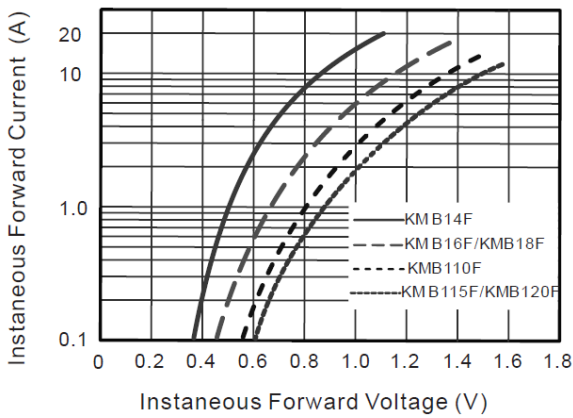

Fig.4 Typical Junction Capacitance

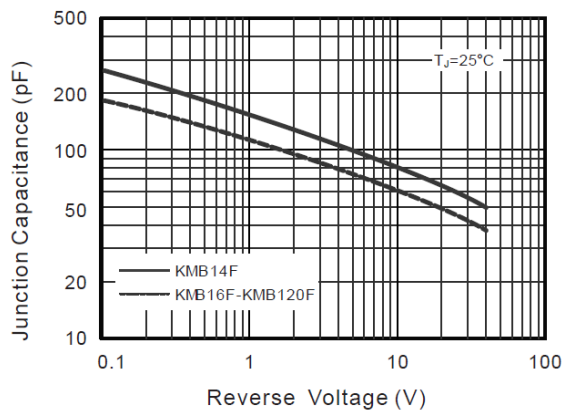

Fig.5 Maximum Non-Repetitive Peak Forward Surge Current

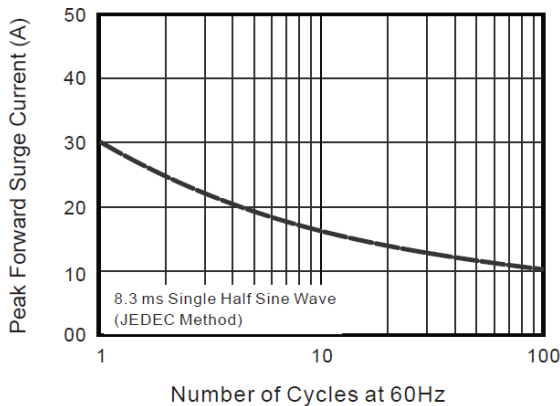
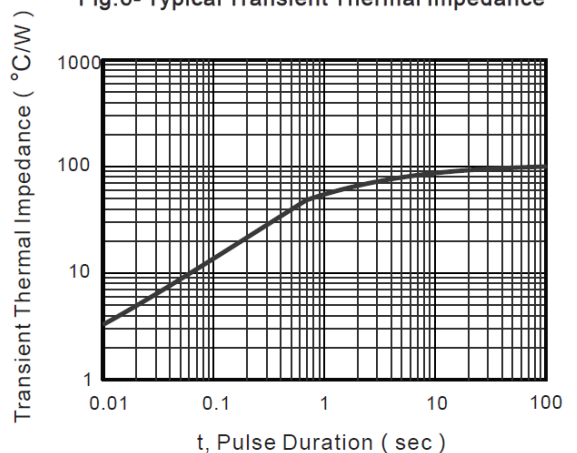

Fig.6- Typical Transient Thermal Impedance



SMD BRIDGE RECTIFIER MBF SERIES

TAPE/REEL (Unit: mm)

All Devices are packed in accordance with EIA standard RS-481-A and specifications.

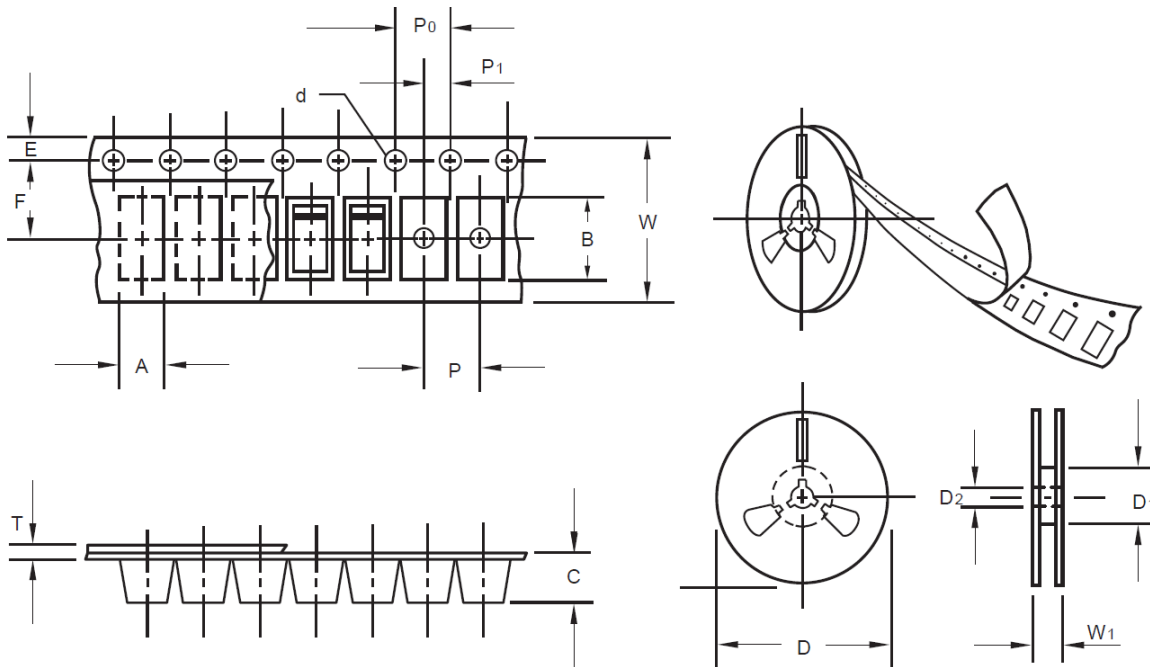

Item	Symbol	Tolerance	MBF
Carrier width	A	0.1	2.8
Carrier Length	B	0.1	5.33
Carrier Depth	C	0.1	2.36
Sprocket hole	d	0.05	1.50
13" Reel outside diameter	D	2.0	330.00
13" Reel inner diameter	D1	Min.	50.00
7" Reel outside diameter	D	-	-
7" Reel inner diameter	D1	-	-
Feed hole diameter	D2	0.5	13.00
Sprocket hole position	E	0.1	1.75
Punch hole position	F	0.1	5.50
Punch hole pitch	P	0.1	4.00
Sprocket hole pitch	P0	0.1	4.00
Embossment center	P1	0.1	2.0
Overall tape thickness	T	0.1	0.28
Tape width	W	0.3	12.00
Reel width	W1	1.0	18.0

SMD BRIDGE RECTIFIER MBF SERIES

PACKAGE

Case Code	Reel Size	MPQ (pcs)	Component Spacing (mm)	Qty. Per Box (pcs)	Inner Box L*W*H (mm)	Reel Size (mm)	Carton size L*W*H (mm)	Qty. Per Carton (pcs)	G. W (kg)
MBF	13"	5,000	-	10,000	335*340*40	330	380*380*380	80,000	14.4

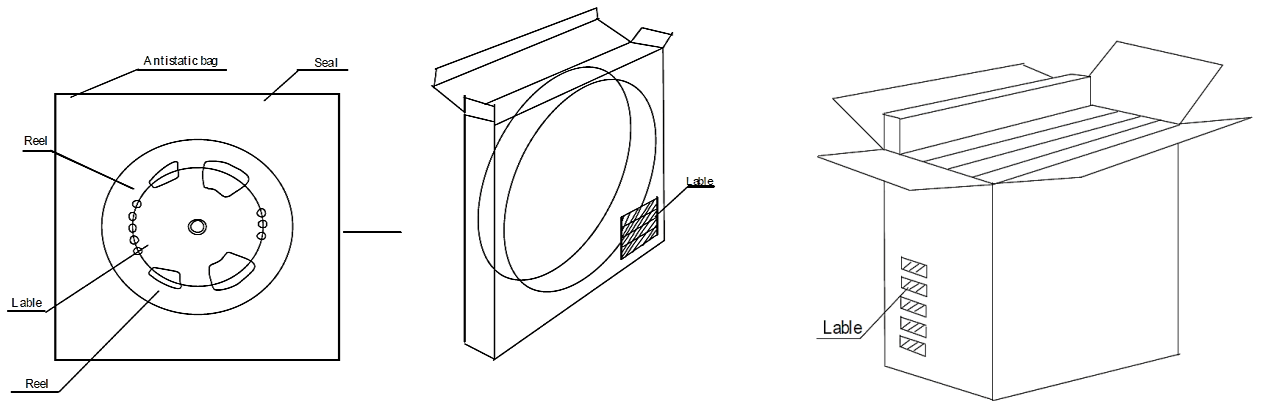

DISCLAIMER

NextGen Component, Inc. reserves the right to make changes to the product(s) and or information contained herein without notice. No liability is assumed as a result of their use or application. No rights under any patent accompany the sale of any such product(s) or information







Looking for pricing, stock, or lifecycle information?

Click below to explore more details on WIN SOURCE:

 [View KMB14F on WIN SOURCE](#)

 [MDD Information](#)

Optimize Your Supply Chain with WIN SOURCE Solutions

-  Global Sourcing Solution
-  Obsolete Management
-  Cost Control Management
-  Shortage Management
-  Alternative Solution
-  Excess Inventory Management