



**THE DATASHEET OF
NCP2890DMR2**



NCP2890, NCV2890

Audio Power Amplifier, 1.0 W

The NCP2890 is an audio power amplifier designed for portable communication device applications such as mobile phone applications. The NCP2890 is capable of delivering 1.0 W of continuous average power to an 8.0 Ω BTL load from a 5.0 V power supply, and 320 mW to a 4.0 Ω BTL load from a 2.6 V power supply.

The NCP2890 provides high quality audio while requiring few external components and minimal power consumption. It features a low-power consumption shutdown mode, which is achieved by driving the SHUTDOWN pin with logic low.

The NCP2890 contains circuitry to prevent from “pop and click” noise that would otherwise occur during turn-on and turn-off transitions.

For maximum flexibility, the NCP2890 provides an externally controlled gain (with resistors), as well as an externally controlled turn-on time (with the bypass capacitor).

Due to its excellent PSRR, it can be directly connected to the battery, saving the use of an LDO.

This device is available in a 9-Pin Flip-Chip CSP (standard –Lead and Lead-Free versions) and a Micro8™ package.

Features

- 1.0 W to an 8.0 Ω BTL Load from a 5.0 V Power Supply
- Excellent PSRR: Direct Connection to the Battery
- “Pop and Click” Noise Protection Circuit
- Ultra Low Current Shutdown Mode
- 2.2 V–5.5 V Operation
- External Gain Configuration Capability
- External Turn-on Time Configuration Capability
- Up to 1.0 nF Capacitive Load Driving Capability
- Thermal Overload Protection Circuitry
- AEC-Q100 Qualified Part Available
- Pb-Free Packages are Available
- NCV Prefix for Automotive and Other Applications Requiring Site and Control Changes

Typical Applications

- Portable Electronic Devices
- PDAs
- Wireless Phones



ON Semiconductor®

<http://onsemi.com>

MARKING DIAGRAMS



9-Pin Flip-Chip CSP
FC SUFFIX
CASE 499E

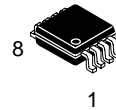
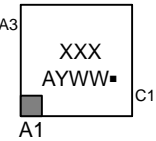

Micro8
DM SUFFIX
CASE 846A

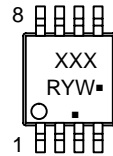

XXX = Specific Device Code,
A, R = Assembly Location
Y = Year
WW, W = Work Week
▪ = Pb-Free Package

PIN CONNECTIONS

9-Pin Flip-Chip CSP

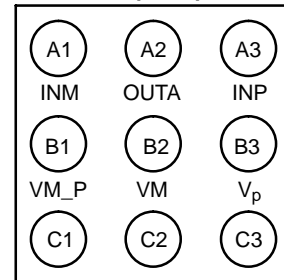

BYPASS OUTB SHUTDOWN
(Top View)

Micro8

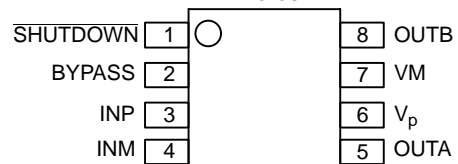

(Top View)

ORDERING INFORMATION

See detailed ordering and shipping information in the package dimensions section on page 14 of this data sheet.

NCP2890, NCV2890

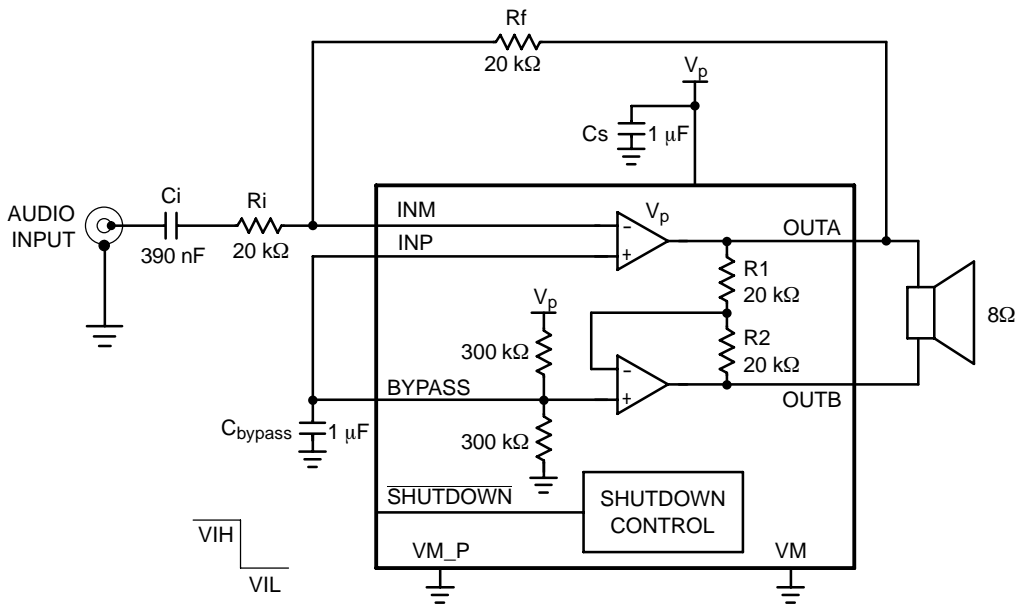

Figure 1. Typical Audio Amplifier Application Circuit with Single Ended Input

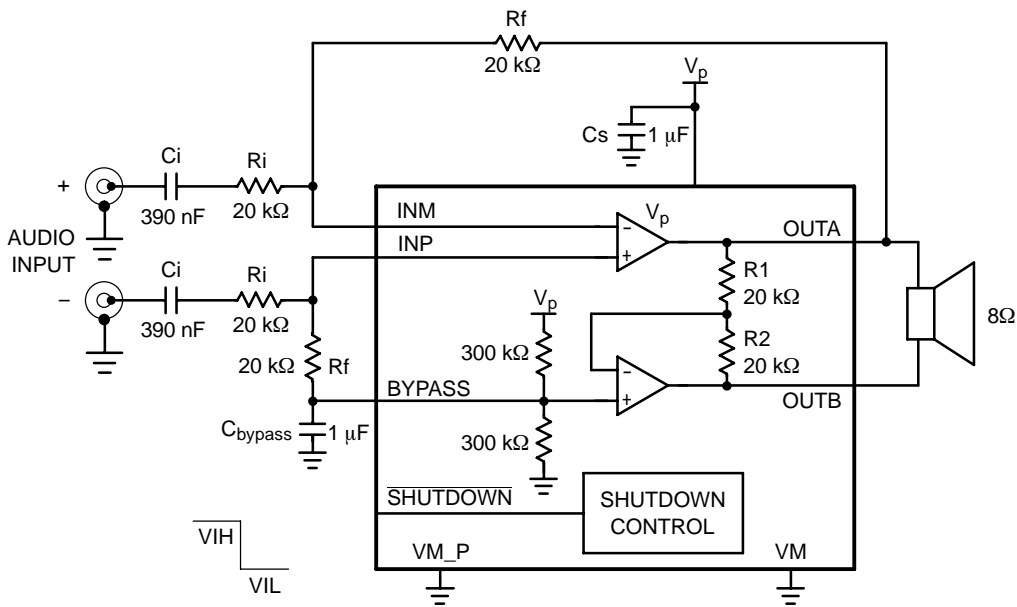

Figure 2. Typical Audio Amplifier Application Circuit with a Differential Input

This device contains 671 active transistors and 1899 MOS gates.

NCP2890, NCV2890

PIN DESCRIPTION

9-Pin Flip-Chip CSP	Micro8	Type	Symbol	Description
A1	4	I	INM	Negative input of the first amplifier, receives the audio input signal. Connected to the feedback resistor R_f and to the input resistor R_{in} .
A2	5	O	OUTA	Negative output of the NCP2890. Connected to the load and to the feedback resistor R_f .
A3	3	I	INP	Positive input of the first amplifier, receives the common mode voltage.
B1	NA	I	VM_P	Power Analog Ground.
B2	7	I	VM	Core Analog Ground.
B3	6	I	V_p	Positive analog supply of the cell. Range: 2.2 V–5.5 V.
C1	2	I	BYPASS	Bypass capacitor pin which provides the common mode voltage ($V_p/2$).
C2	8	O	OUTB	Positive output of the NCP2890. Connected to the load.
C3	1	I	SHUTDOWN	The device enters in shutdown mode when a low level is applied on this pin.

MAXIMUM RATINGS (Note 1)

Rating	Symbol	Value	Unit	
Supply Voltage	V_p	6.0	V	
Operating Supply Voltage	Op V_p	2.2 to 5.5 V 2.0 V = Functional Only	–	
Input Voltage	V_{in}	–0.3 to $V_{cc} + 0.3$	V	
Max Output Current	I_{out}	500	mA	
Power Dissipation (Note 2)	P_d	Internally Limited	–	
Operating Ambient Temperature	T_A	–40 to +85	°C	
Max Junction Temperature	T_J	150	°C	
Storage Temperature Range	T_{stg}	–65 to +150	°C	
Thermal Resistance Junction-to-Air	$R_{\theta JA}$	230 (Note 3)	°C/W	
ESD Protection	Human Body Model (HBM) (Note 4)	–	8000	V
	Machine Model (MM) (Note 5)	–	>250	

Stresses exceeding Maximum Ratings may damage the device. Maximum Ratings are stress ratings only. Functional operation above the Recommended Operating Conditions is not implied. Extended exposure to stresses above the Recommended Operating Conditions may affect device reliability.

- Maximum electrical ratings are defined as those values beyond which damage to the device may occur at $T_A = +25^\circ\text{C}$.
- The thermal shutdown set to 160°C (typical) avoids irreversible damage on the device due to power dissipation. For further information see page 10.
- For the 9-Pin Flip-Chip CSP package, the $R_{\theta JA}$ is highly dependent of the PCB Heatsink area. For example, $R_{\theta JA}$ can equal 195°C/W with 50 mm^2 total area and also 135°C/W with 500 mm^2 . For further information see page 10. The bumps have the same thermal resistance and all need to be connected to optimize the power dissipation.
- Human Body Model, 100 pF discharge through a $1.5\text{ k}\Omega$ resistor following specification JESD22/A114.
- Machine Model, 200 pF discharged through all pins following specification JESD22/A115.

NCP2890, NCV2890

ELECTRICAL CHARACTERISTICS Limits apply for T_A between -40°C to $+85^{\circ}\text{C}$ (Unless otherwise noted).

Characteristic	Symbol	Conditions	Min (Note 6)	Typ	Max (Note 6)	Unit
Supply Quiescent Current	I_{dd}	$V_p = 2.6\text{ V}$, No Load	–	1.5	4	mA
		$V_p = 5.0\text{ V}$, No Load	–	1.7		
		$V_p = 2.6\text{ V}$, $8\ \Omega$ $V_p = 5.0\text{ V}$, $8\ \Omega$	– –	1.7 1.9	5.5	
Common Mode Voltage	V_{cm}	–	–	$V_p/2$	–	V
Shutdown Current	I_{SD}	–	–	10	600	nA
Shutdown Voltage High	V_{SDIH}	–	1.2	–	–	V
Shutdown Voltage Low	V_{SDIL}	–	–	–	0.4	V
Turning On Time (Note 8)	T_{WU}	$C_{by} = 1\ \mu\text{F}$	–	285	–	ms
Output Swing	$V_{loadpeak}$	$V_p = 2.6\text{ V}$, $R_L = 8.0\ \Omega$	2.0	2.12	–	V
		$V_p = 5.0\text{ V}$, $R_L = 8.0\ \Omega$ (Note 7)	4.0	4.15	–	
Rms Output Power	P_O	$V_p = 2.6\text{ V}$, $R_L = 4.0\ \Omega$ THD + N < 0.1%	–	0.36	–	W
		$V_p = 2.6\text{ V}$, $R_L = 8.0\ \Omega$ THD + N < 0.1%	–	0.28	–	
		$V_p = 5.0\text{ V}$, $R_L = 8.0\ \Omega$ THD + N < 0.1%	–	1.08	–	
Maximum Power Dissipation (Note 8)	P_{Dmax}	$V_p = 5.0\text{ V}$, $R_L = 8.0\ \Omega$	–	–	0.65	W
Output Offset Voltage	V_{OS}	$V_p = 2.6\text{ V}$ $V_p = 5.0\text{ V}$	–30	–	30	mV
Signal-to-Noise Ratio	SNR	$V_p = 2.6\text{ V}$, $G = 2.0$ $10\text{ Hz} < F < 20\text{ kHz}$	–	84	–	dB
		$V_p = 5.0\text{ V}$, $G = 10$ $10\text{ Hz} < F < 20\text{ kHz}$	–	77	–	
Positive Supply Rejection Ratio	PSRR V_+	$G = 2.0$, $R_L = 8.0\ \Omega$ $V_{Pripple_pp} = 200\text{ mV}$ $C_{by} = 1.0\ \mu\text{F}$ Input Terminated with $10\ \Omega$				dB
		$F = 217\text{ Hz}$ $V_p = 5.0\text{ V}$	–	–64	–	
		$V_p = 3.0\text{ V}$	–	–72	–	
		$V_p = 2.6\text{ V}$	–	–73	–	
		$F = 1.0\text{ kHz}$ $V_p = 5.0\text{ V}$	–	–64	–	
		$V_p = 3.0\text{ V}$	–	–74	–	
Efficiency	η	$V_p = 2.6\text{ V}$, $P_{orms} = 320\text{ mW}$	–	48	–	%
		$V_p = 5.0\text{ V}$, $P_{orms} = 1.0\text{ W}$	–	63	–	
Thermal Shutdown Temperature (Note 9)	T_{sd}		140	160	180	$^{\circ}\text{C}$
Total Harmonic Distortion	THD	$V_p = 2.6$, $F = 1.0\text{ kHz}$ $R_L = 4.0\ \Omega$, $A_V = 2.0$ $P_O = 0.32\text{ W}$	–	–	–	%
			–	0.04	–	
			–	–	–	
			–	–	–	
		$V_p = 5.0\text{ V}$, $F = 1.0\text{ kHz}$ $R_L = 8.0\ \Omega$, $A_V = 2.0$ $P_O = 1.0\text{ W}$	–	–	–	
			–	0.02	–	
			–	–	–	

6. Min/Max limits are guaranteed by design, test or statistical analysis.

7. This parameter is not tested in production for 9-Pin Flip-Chip CSP package in case of a 5.0 V power supply.

8. See page 11 for a theoretical approach of this parameter.

9. For this parameter, the Min/Max values are given for information.

TYPICAL PERFORMANCE CHARACTERISTICS

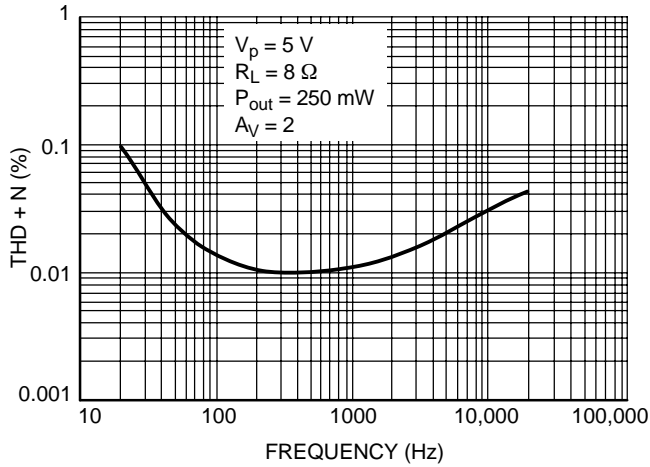

Figure 1. THD + N versus Frequency

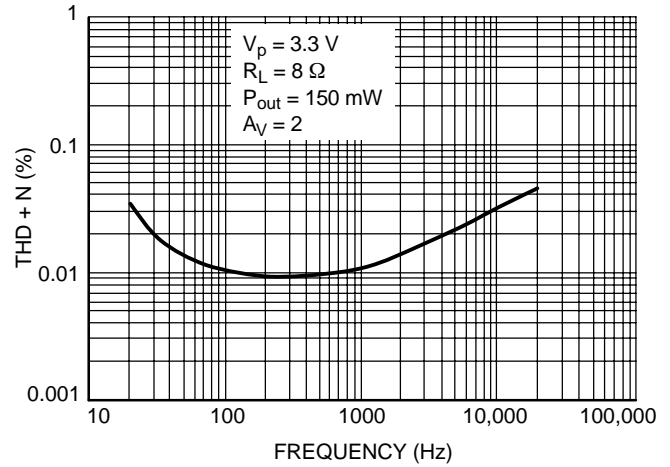

Figure 2. THD + N versus Frequency

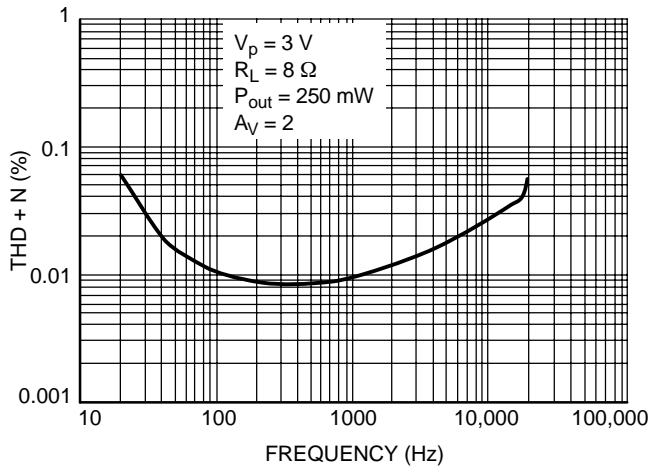

Figure 3. THD + N versus Frequency

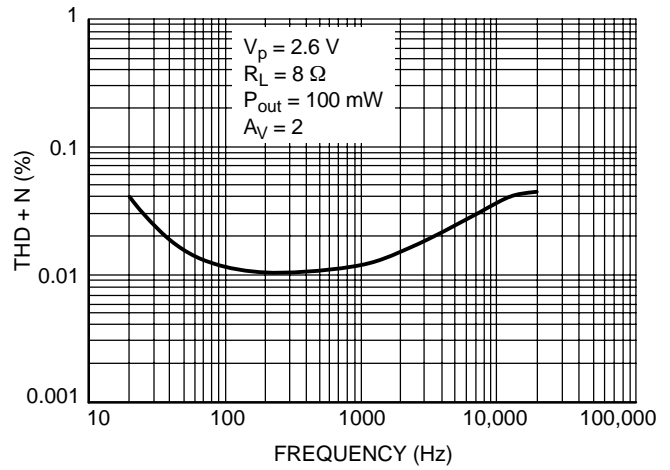

Figure 4. THD + N versus Frequency

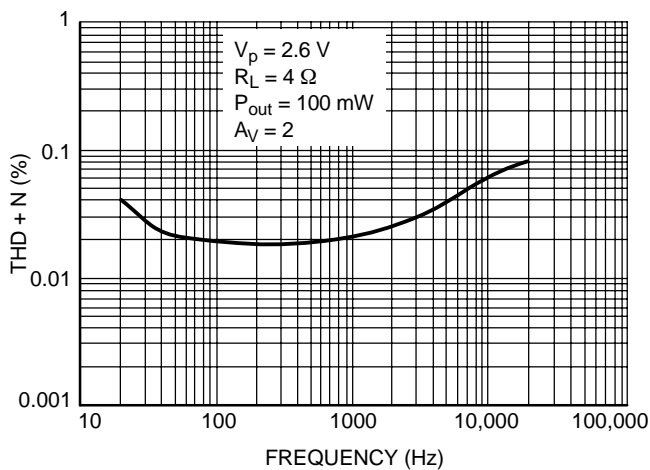

Figure 5. THD + N versus Frequency

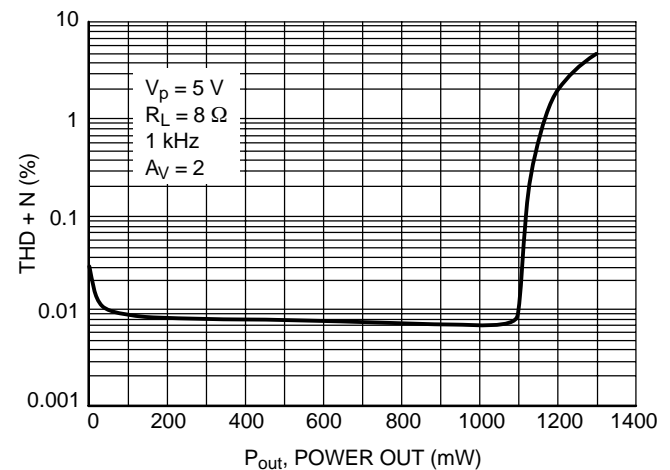

Figure 6. THD + N versus Power Out

NCP2890, NCV2890

TYPICAL PERFORMANCE CHARACTERISTICS

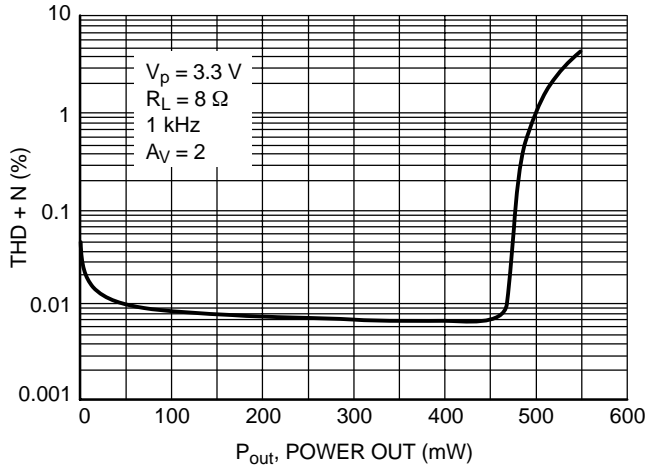

Figure 7. THD + N versus Power Out

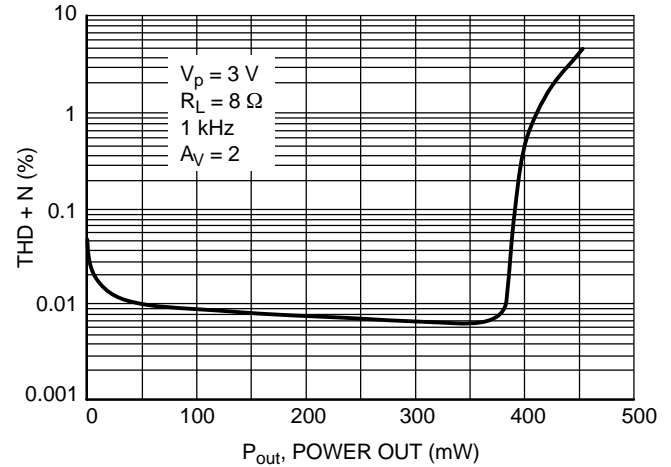

Figure 8. THD + N versus Power Out

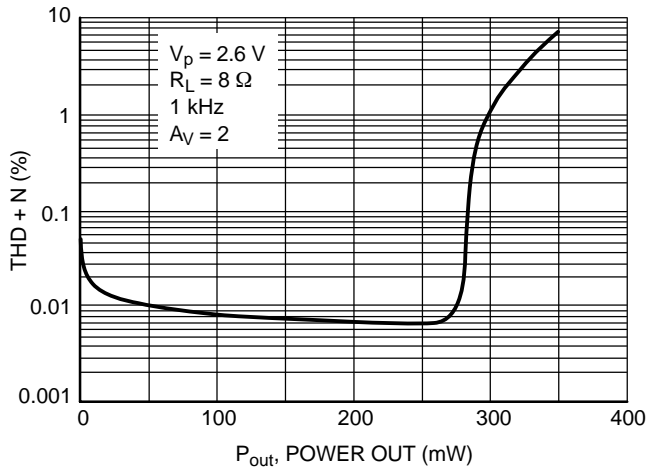

Figure 9. THD + N versus Power Out

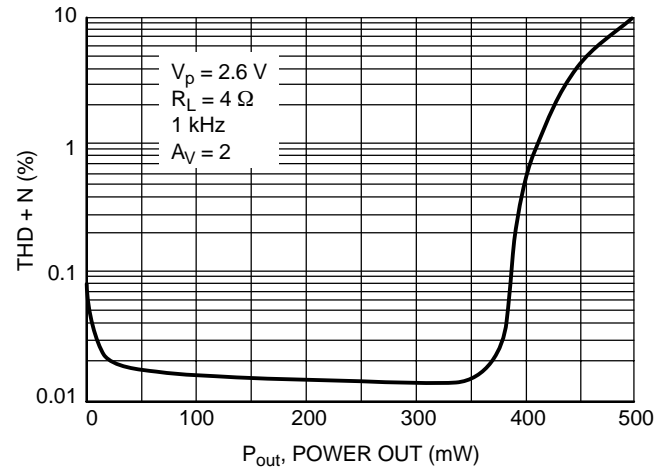

Figure 10. THD + N versus Power Out

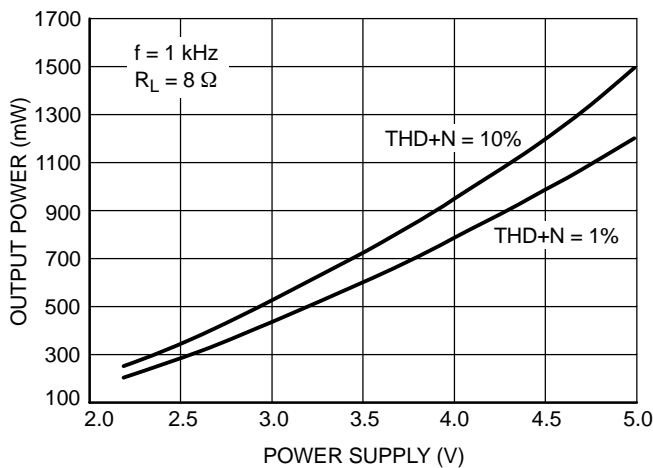

Figure 11. Output Power versus Power Supply

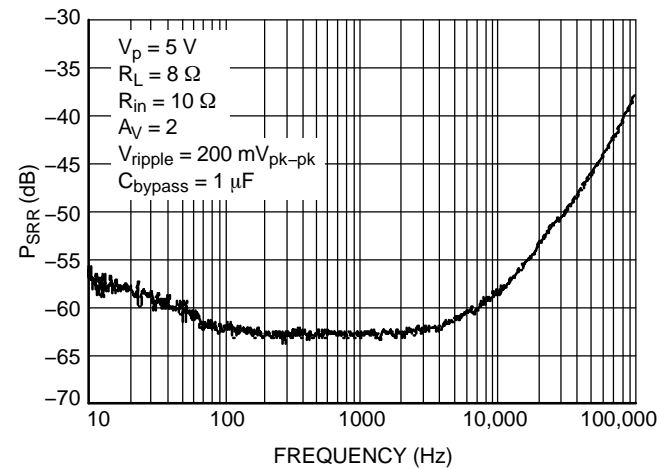

Figure 12. P_{SRR} @ $V_p = 5 V$

TYPICAL PERFORMANCE CHARACTERISTICS

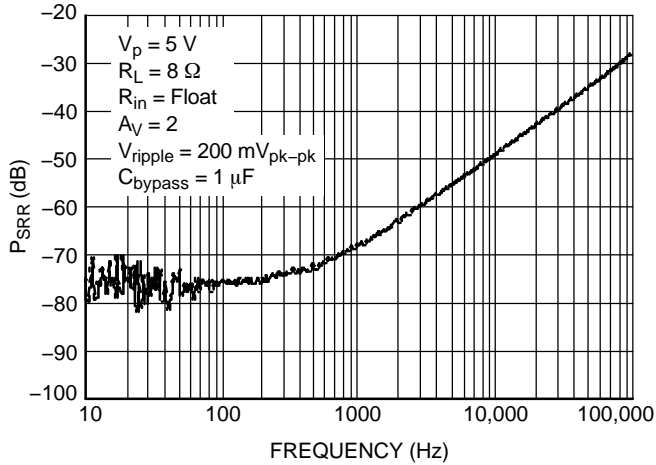

Figure 13. PSRR @ $V_p = 5\text{ V}$

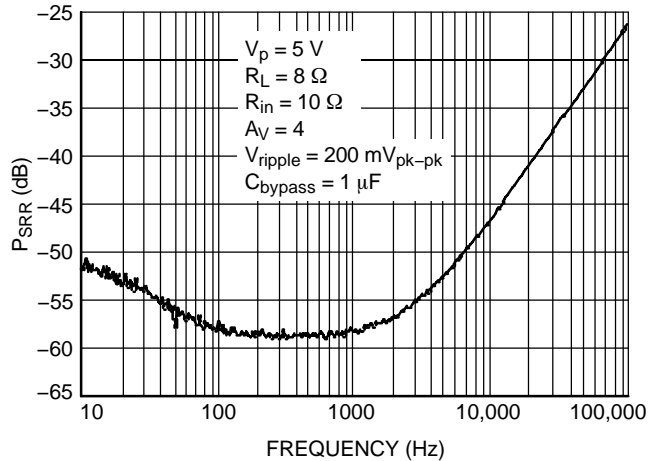

Figure 14. PSRR @ $V_p = 5\text{ V}$

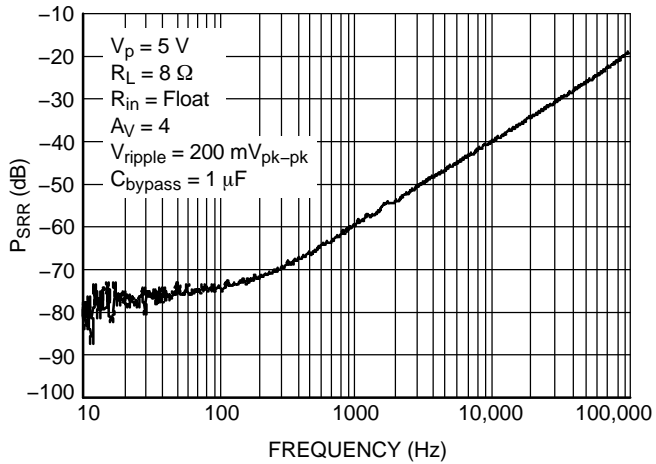

Figure 15. PSRR @ $V_p = 5\text{ V}$

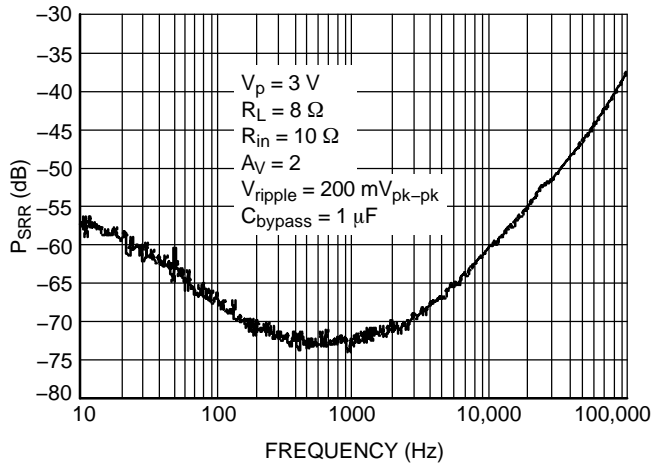

Figure 16. PSRR @ $V_p = 3\text{ V}$

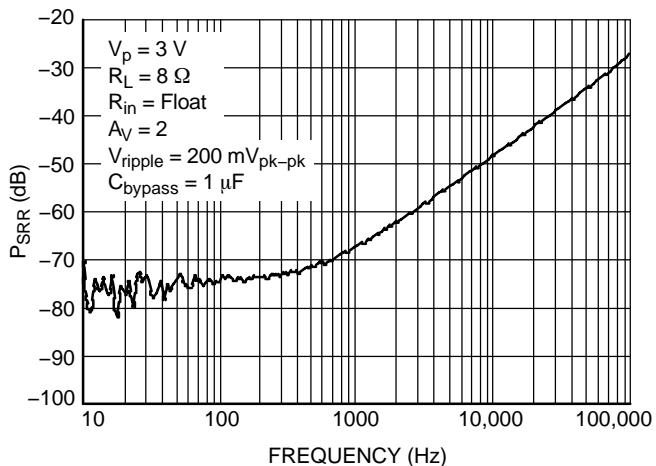

Figure 17. PSRR @ $V_p = 3\text{ V}$

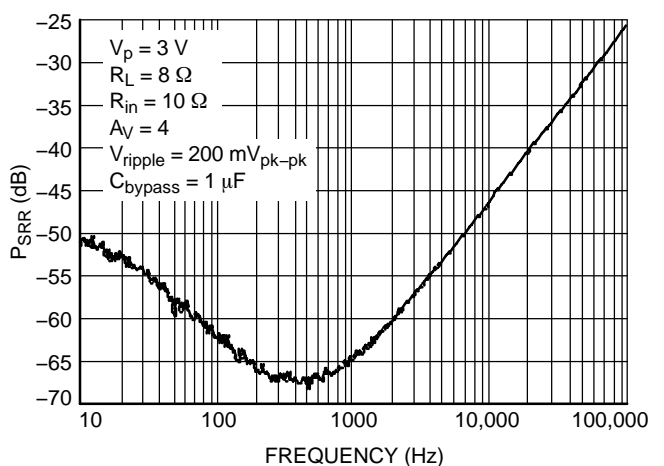

Figure 18. PSRR @ $V_p = 3\text{ V}$

TYPICAL PERFORMANCE CHARACTERISTICS

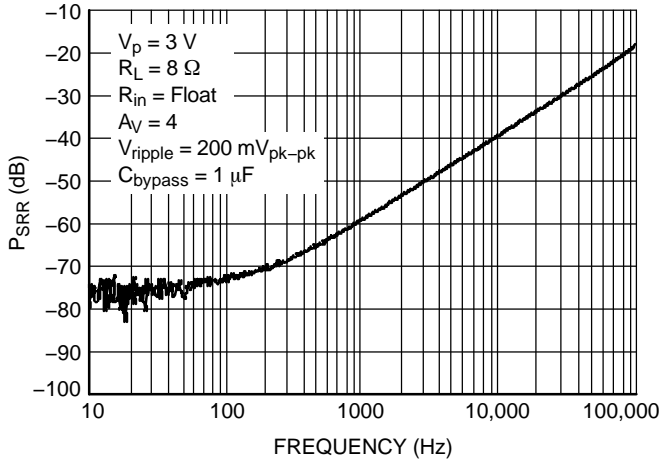

Figure 19. PSRR @ $V_p = 3\text{ V}$

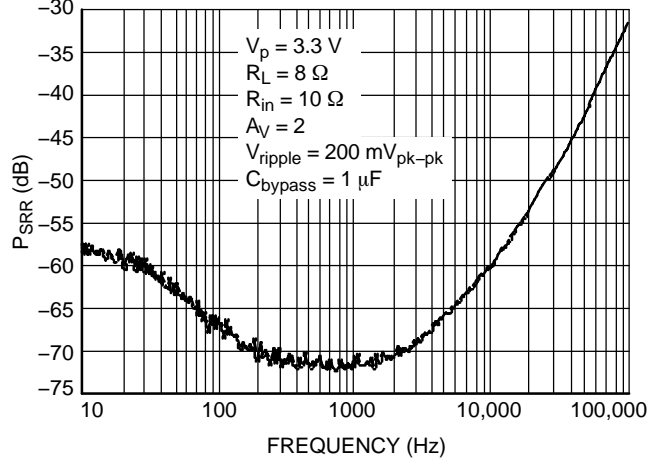

Figure 20. PSRR @ $V_p = 3.3\text{ V}$

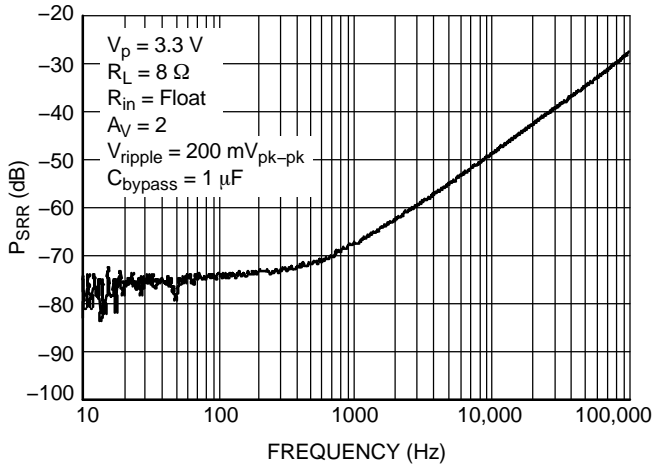

Figure 21. PSRR @ $V_p = 3.3\text{ V}$

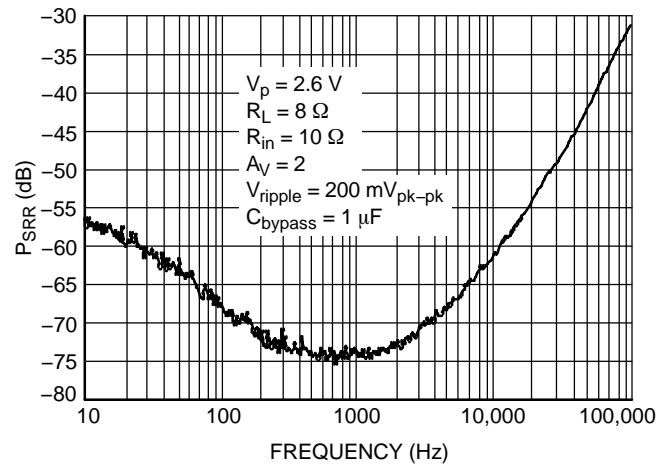

Figure 22. PSRR @ $V_p = 2.6\text{ V}$

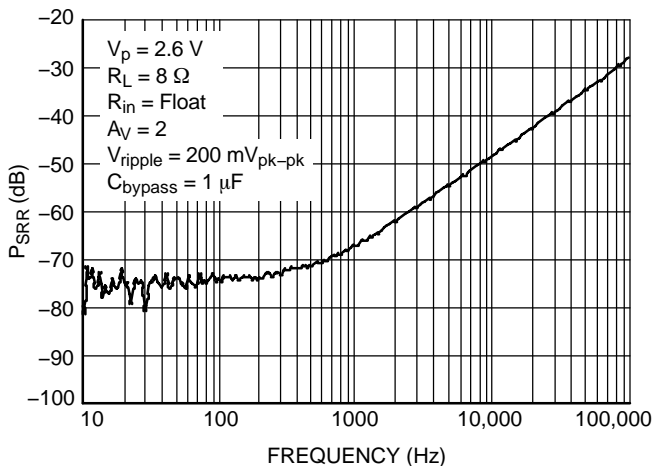

Figure 23. PSRR @ $V_p = 2.6\text{ V}$

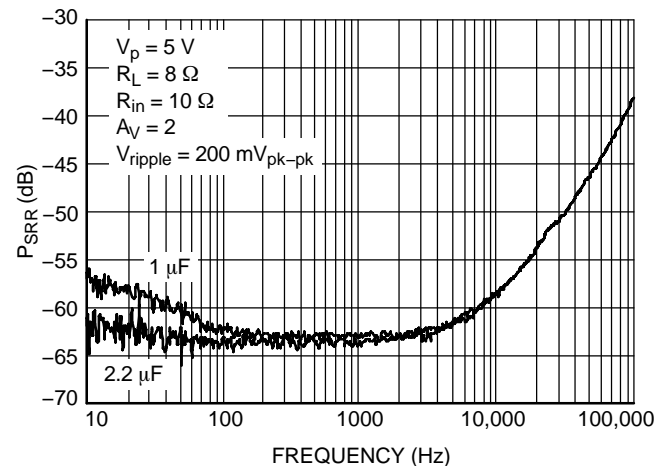

Figure 24. PSRR versus C_{bypass} @ $V_p = 5\text{ V}$

NCP2890, NCV2890

TYPICAL PERFORMANCE CHARACTERISTICS

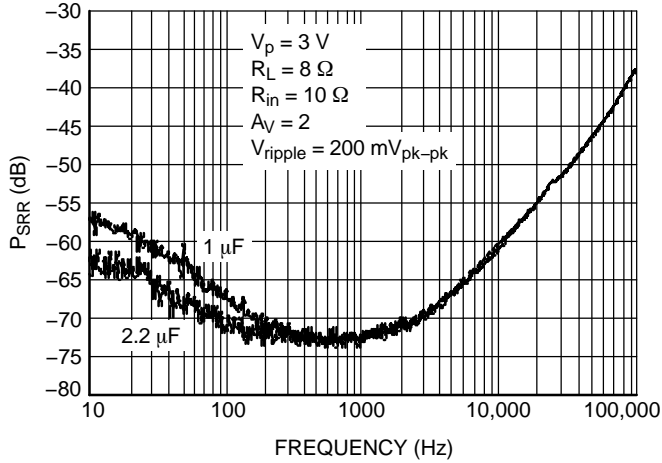

Figure 25. PSRR versus C_{bypass} @ $V_p = 3 V$

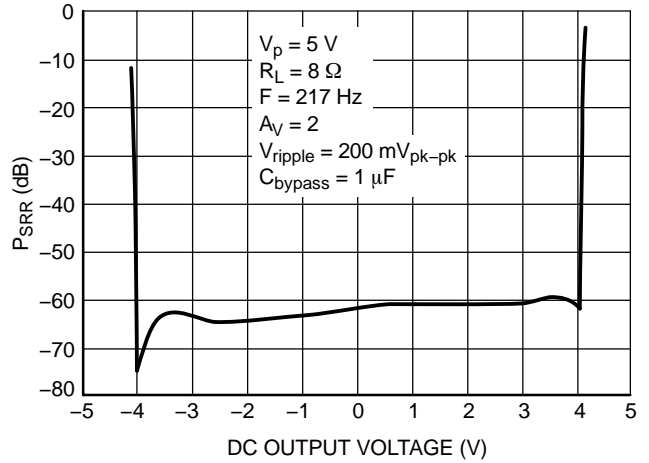

Figure 26. PSRR @ DC Output Voltage

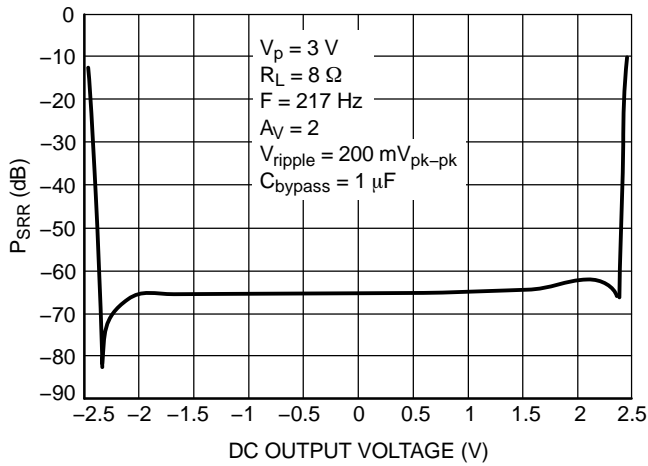

Figure 27. PSRR @ DC Output Voltage

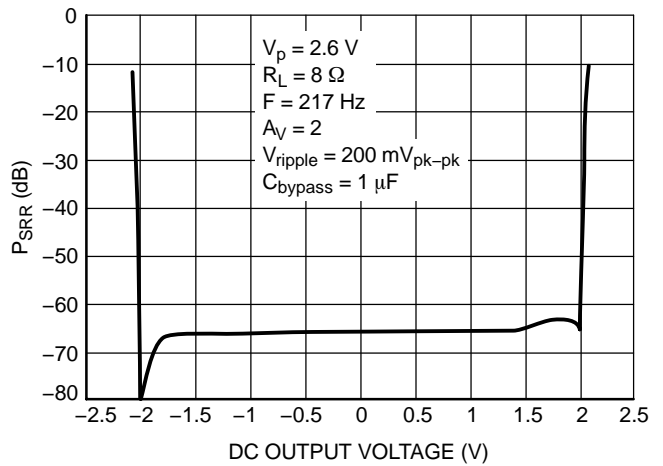

Figure 28. PSRR @ DC Output Voltage

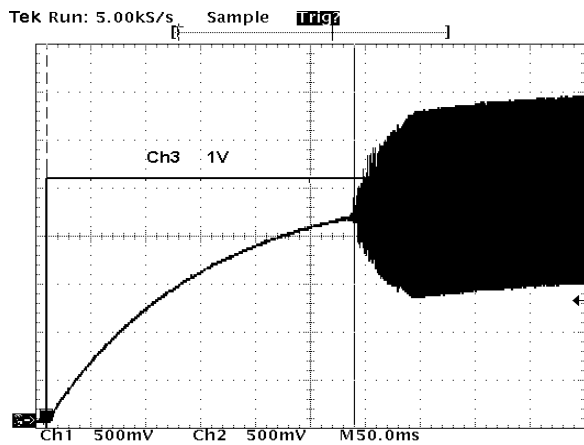

Figure 29. Turning On Time - $V_p = 5 V$

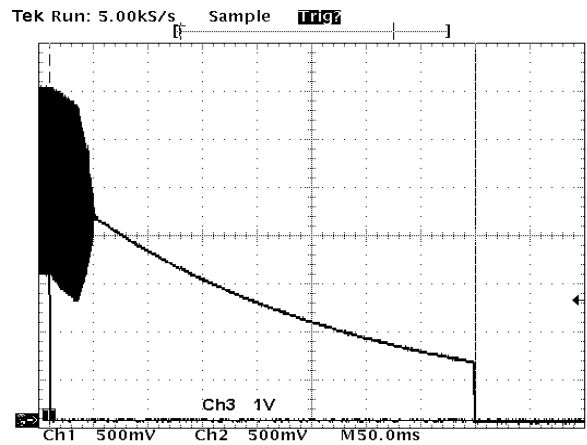

Figure 30. Turning Off Time - $V_p = 5 V$

TYPICAL PERFORMANCE CHARACTERISTICS

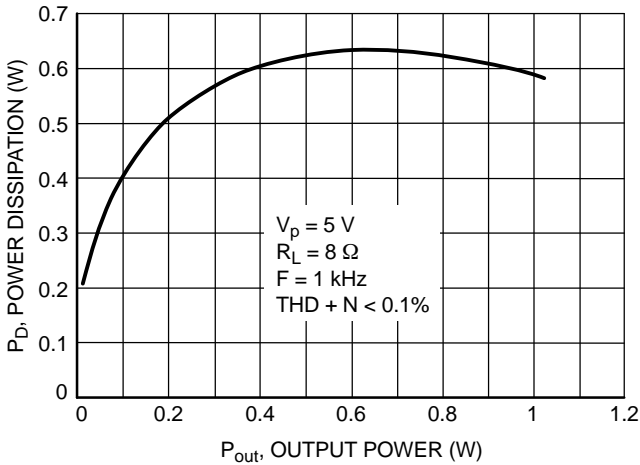

Figure 31. Power Dissipation versus Output Power

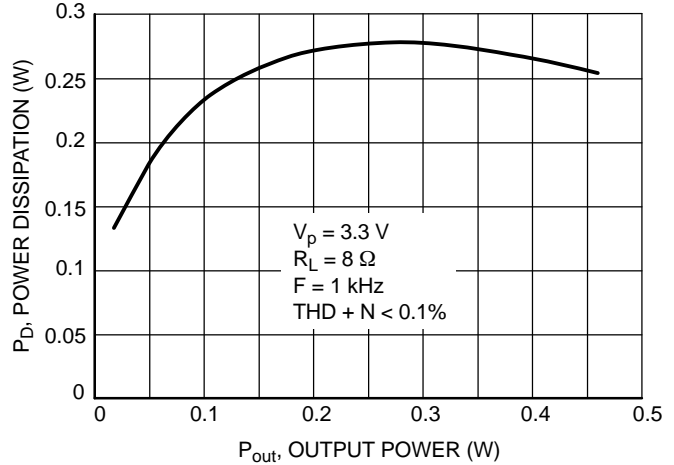

Figure 32. Power Dissipation versus Output Power

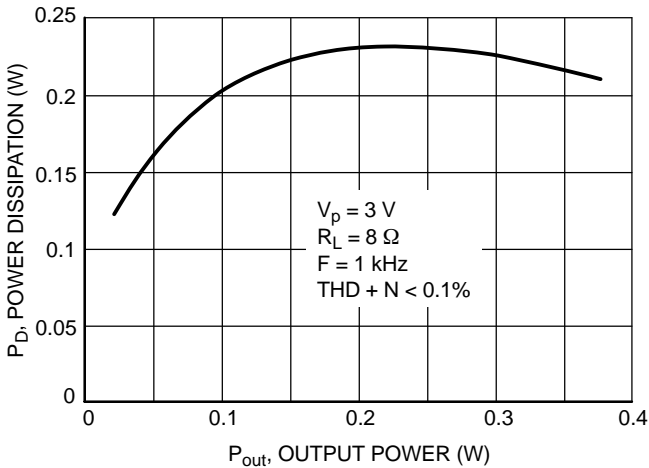

Figure 33. Power Dissipation versus Output Power

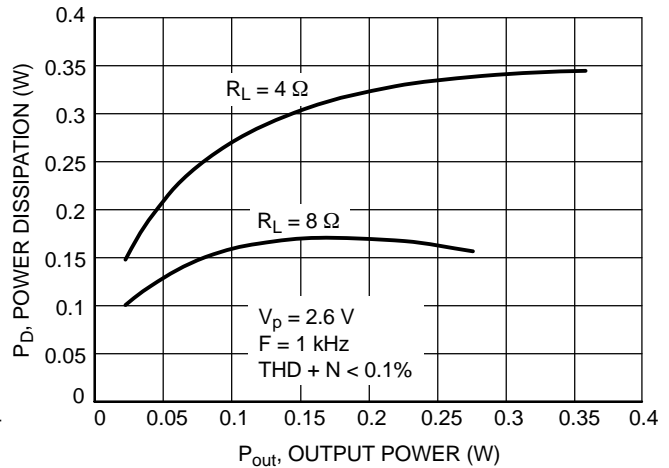

Figure 34. Power Dissipation versus Output Power

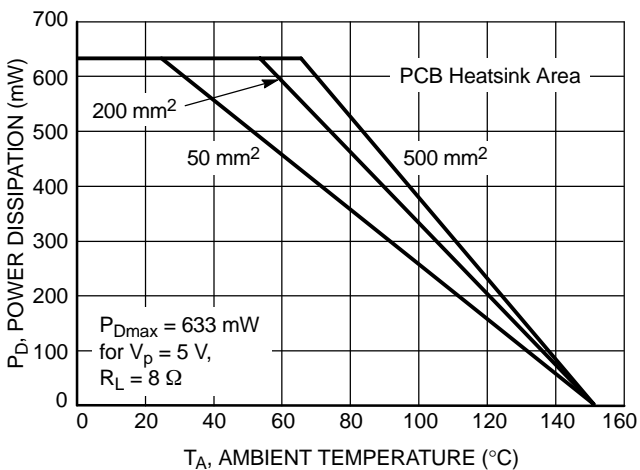

Figure 35. Power Derating - 9-Pin Flip-Chip CSP

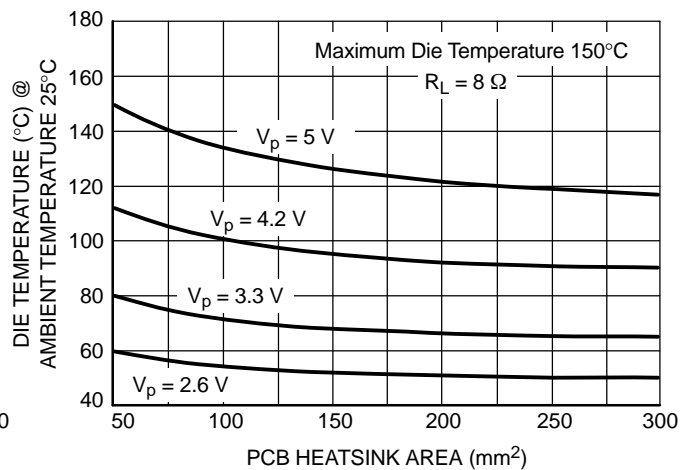

Figure 36. Maximum Die Temperature versus PCB Heatsink Area

APPLICATION INFORMATION

Detailed Description

The NCP2890 audio amplifier can operate under 2.6 V until 5.5 V power supply. It delivers 320 mW rms output power to 4.0 Ω load ($V_p = 2.6$ V) and 1.0 W rms output power to 8.0 Ω load ($V_p = 5.0$ V).

The structure of the NCP2890 is basically composed of two identical internal power amplifiers; the first one is externally configurable with gain-setting resistors R_{in} and R_f (the closed-loop gain is fixed by the ratios of these resistors) and the second is internally fixed in an inverting unity-gain configuration by two resistors of 20 k Ω . So the load is driven differentially through OUTA and OUTB outputs. This configuration eliminates the need for an output coupling capacitor.

Internal Power Amplifier

The output PMOS and NMOS transistors of the amplifier were designed to deliver the output power of the specifications without clipping. The channel resistance (R_{on}) of the NMOS and PMOS transistors does not exceed 0.6 Ω when they drive current.

The structure of the internal power amplifier is composed of three symmetrical gain stages, first and medium gain stages are transconductance gain stages to obtain maximum bandwidth and DC gain.

Turn-On and Turn-Off Transitions

A cycle with a turn-on and turn-off transition is illustrated with plots that show both single ended signals on the previous page.

In order to eliminate “pop and click” noises during transitions, output power in the load must be slowly established or cut. When logic high is applied to the shutdown pin, the bypass voltage begins to rise exponentially and once the output DC level is around the common mode voltage, the gain is established slowly (50 ms). This way to turn-on the device is optimized in terms of rejection of “pop and click” noises.

The device has the same behavior when it is turned-off by a logic low on the shutdown pin. During the shutdown mode, amplifier outputs are connected to the ground.

When a shutdown low level is applied, it takes 350 ms before the DC output level is tied to Ground. However, as shown on Figure 30, the turn off time of the audio signal is 40 ms.

A theoretical value of turn-on time at 25°C is given by the following formula.

C_{by} : bypass capacitor

R: internal 300 k resistor with a 25% accuracy

$$T_{on} = 0.95 * R * C_{by} \text{ (285 ms with } C_{by} = 1 \mu\text{F)}$$

If a faster turn on time is required then a lower bypass capacitor can be used. The other option is to use NCP2892 which offers 100 ms with 1 μ F bypass capacitor.

Shutdown Function

The device enters shutdown mode when shutdown signal is low. During the shutdown mode, the DC quiescent current of the circuit does not exceed 100 nA.

Current Limit Circuit

The maximum output power of the circuit ($P_{orms} = 1.0$ W, $V_p = 5.0$ V, $R_L = 8.0$ Ω) requires a peak current in the load of 500 mA.

In order to limit the excessive power dissipation in the load when a short-circuit occurs, the current limit in the load is fixed to 800 mA. The current in the four output MOS transistors are real-time controlled, and when one current exceeds 800 mA, the gate voltage of the MOS transistor is clipped and no more current can be delivered.

Thermal Overload Protection

Internal amplifiers are switched off when the temperature exceeds 160°C, and will be switched on again only when the temperature decreases fewer than 140°C.

The NCP2890 is unity-gain stable and requires no external components besides gain-setting resistors, an input coupling capacitor and a proper bypassing capacitor in the typical application.

The first amplifier is externally configurable (R_f and R_{in}), while the second is fixed in an inverting unity gain configuration.

The differential-ended amplifier presents two major advantages:

- The possible output power is four times larger (the output swing is doubled) as compared to a single-ended amplifier under the same conditions.
- Output pins (OUTA and OUTB) are biased at the same potential $V_p/2$, this eliminates the need for an output coupling capacitor required with a single-ended amplifier configuration.

The differential closed loop-gain of the amplifier is given by $A_{vd} = 2 * \frac{R_f}{R_{in}} = \frac{V_{orms}}{V_{inrms}}$.

Output power delivered to the load is given by $P_{orms} = \frac{(V_{opeak})^2}{2 * R_L}$ (V_{opeak} is the peak differential output voltage).

When choosing gain configuration to obtain the desired output power, check that the amplifier is not current limited or clipped.

The maximum current which can be delivered to the load is 500 mA $I_{opeak} = \frac{V_{opeak}}{R_L}$.

NCP2890, NCV2890

Gain-Setting Resistor Selection (R_{in} and R_f)

R_{in} and R_f set the closed-loop gain of the amplifier.

In order to optimize device and system performance, the NCP2890 should be used in low gain configurations.

The low gain configuration minimizes THD + noise values and maximizes the signal to noise ratio, and the amplifier can still be used without running into the bandwidth limitations.

A closed loop gain in the range from 2 to 5 is recommended to optimize overall system performance.

An input resistor (R_{in}) value of 22 k Ω is realistic in most of applications, and doesn't require the use of a too large capacitor C_{in} .

Input Capacitor Selection (C_{in})

The input coupling capacitor blocks the DC voltage at the amplifier input terminal. This capacitor creates a high-pass filter with R_{in} , the cut-off frequency is given by

$$f_c = \frac{1}{2 * \pi * R_{in} * C_{in}}$$

The size of the capacitor must be large enough to couple in low frequencies without severe attenuation. However a large input coupling capacitor requires more time to reach its quiescent DC voltage ($V_p/2$) and can increase the turn-on pops.

An input capacitor value between 0.1 μ and 0.39 μ F performs well in many applications (With $R_{in} = 22$ K Ω).

Bypass Capacitor Selection (C_{by})

The bypass capacitor C_{by} provides half-supply filtering and determines how fast the NCP2890 turns on.

This capacitor is a critical component to minimize the turn-on pop. A 1.0 μ F bypass capacitor value ($C_{in} = < 0.39$ μ F) should produce clickless and popless shutdown transitions. The amplifier is still functional with a 0.1 μ F capacitor value but is more susceptible to "pop and click" noises.

Thus, a 1.0 μ F bypassing capacitor is recommended.

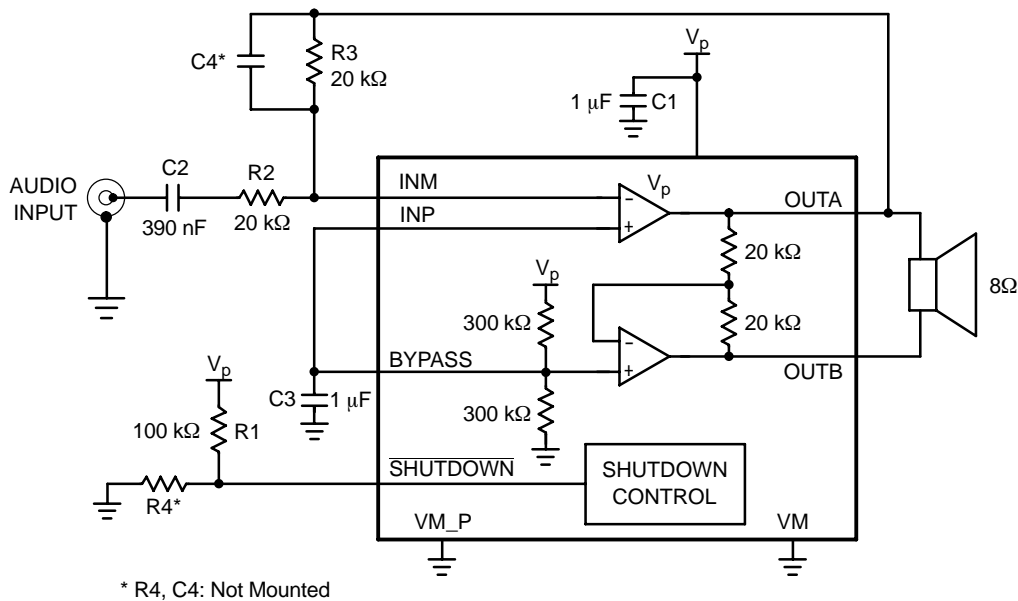
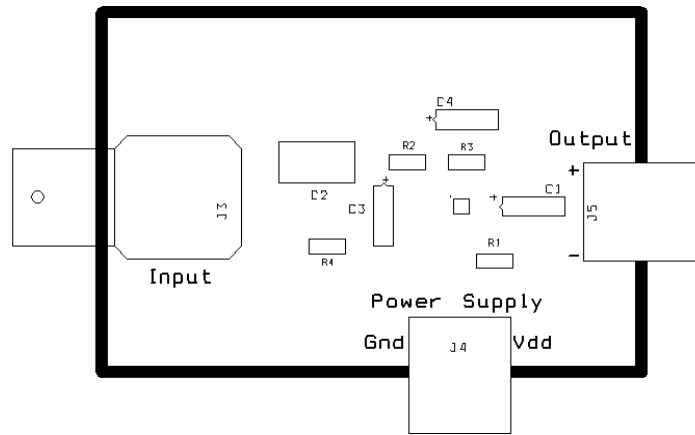
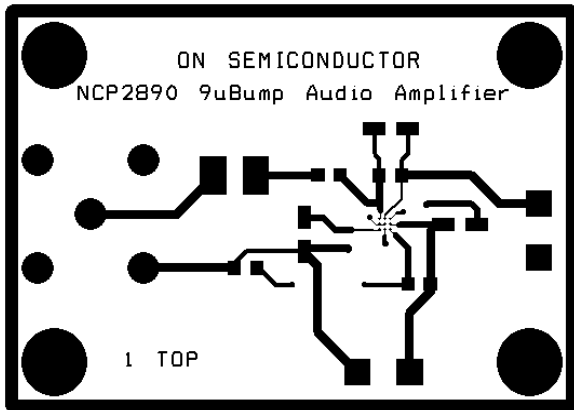

Figure 37. Schematic of the Demonstration Board of the 9-Pin Flip-Chip CSP Device

NCP2890, NCV2890



Silkscreen Layer



Top Layer

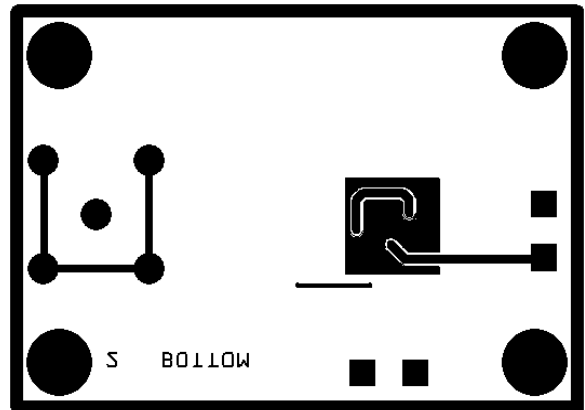

Bottom Layer

Figure 38. Demonstration Board for 9-Pin Flip-Chip CSP Device – PCB Layers

NCP2890, NCV2890

BILL OF MATERIAL

Item	Part Description	Ref.	PCB Footprint	Manufacturer	Manufacturer Reference
1	NCP2890 Audio Amplifier	–	–	ON Semiconductor	NCP2890
2	SMD Resistor 100 K Ω	R1	0805	Vishay–Draloric	D12CRCW Series
3	SMD Resistor 20 K Ω	R2, R3	0805	Vishay–Draloric	CRCW0805 Series
4	Ceramic Capacitor 1.0 μ F 16 V X7R	C1	1206	Murata	GRM42–6X7R105K16
5	Ceramic Capacitor 390 nF 50 V Z5U	C2	1812	Kemet	C1812C394M5UAC
6	Ceramic Capacitor 1.0 μ F 16 V X7R	C3	1206	Murata	GRM42–6X7R105K16
7	Not Mounted	R4, C4	–	–	–
8	BNC Connector	J3	–	Telegartner	JO1001A1948
9	I/O Connector. It can be plugged by BLZ5.08/2 (Weidmüller Reference)	J4, J5	–	Weidmüller	SL5.08/2/90B

ORDERING INFORMATION

Device	Marking	Package	Shipping†
NCP2890AFCT2	MAG	9–Pin Flip–Chip CSP	3000/Tape and Reel
NCP2890AFCT2G	MAH	9–Pin Flip–Chip CSP (Pb–Free)	3000/Tape and Reel
NCP2890DMR2	MAB	Micro8	4000/Tape and Reel
NCP2890DMR2G	MAB	Micro8 (Pb–Free)	4000/Tape and Reel
NCV2890DMR2G	MBZ	Micro8 (Pb–Free)	4000/Tape and Reel

NOTE: This product is offered with either eutectic (SnPb–tin/lead) or lead–free solder bumps (G suffix) depending on the PCB assembly process. The NCP2890AFCT2G version requires a lead–free solder paste and should not be used with a SnPb solder paste.

†For information on tape and reel specifications, including part orientation and tape sizes, please refer to our Tape and Reel Packaging Specifications Brochure, BRD8011/D.

MECHANICAL CASE OUTLINE

PACKAGE DIMENSIONS

ON Semiconductor®



9 PIN FLIP-CHIP CASE 499E-01 ISSUE A

DATE 30 JUN 2004



SCALE 4:1

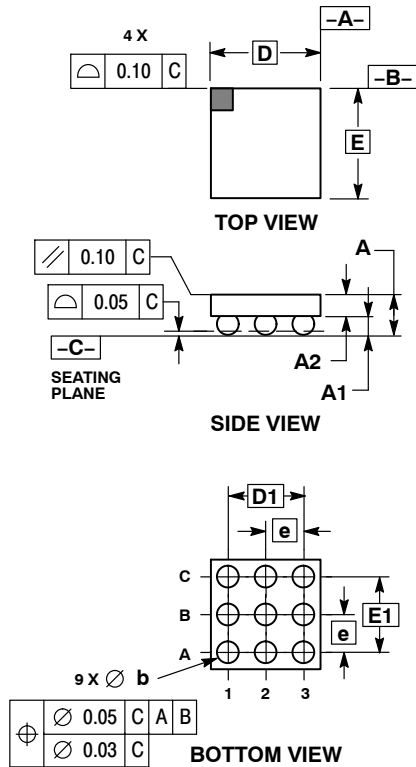

NOTES:

1. DIMENSIONING AND TOLERANCING PER ANSI Y14.5M, 1982.
2. CONTROLLING DIMENSION: MILLIMETERS.
3. COPLANARITY APPLIES TO SPHERICAL CROWNS OF SOLDER BALLS.

MILLIMETERS		
DIM	MIN	MAX
A	0.540	0.660
A1	0.210	0.270
A2	0.330	0.390
D	1.450 BSC	
E	1.450 BSC	
b	0.290	0.340
e	0.500 BSC	
D1	1.000 BSC	
E1	1.000 BSC	

GENERIC MARKING DIAGRAM*

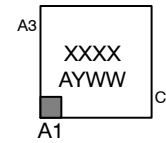

- XXXX = Specific Device Code
- A = Assembly Location
- Y = Year
- WW = Work Week
- G or ■ = Pb-Free Package

*This information is generic. Please refer to device data sheet for actual part marking. Pb-Free indicator, "G" or microdot "■", may or may not be present.

DOCUMENT NUMBER:	98AON12066D	Electronic versions are uncontrolled except when accessed directly from the Document Repository. Printed versions are uncontrolled except when stamped "CONTROLLED COPY" in red.
DESCRIPTION:	9 PIN FLIP-CHIP, 1.45 X 1.45 MM	PAGE 1 OF 1

ON Semiconductor and are trademarks of Semiconductor Components Industries, LLC dba ON Semiconductor or its subsidiaries in the United States and/or other countries. ON Semiconductor reserves the right to make changes without further notice to any products herein. ON Semiconductor makes no warranty, representation or guarantee regarding the suitability of its products for any particular purpose, nor does ON Semiconductor assume any liability arising out of the application or use of any product or circuit, and specifically disclaims any and all liability, including without limitation special, consequential or incidental damages. ON Semiconductor does not convey any license under its patent rights nor the rights of others.

MECHANICAL CASE OUTLINE

PACKAGE DIMENSIONS

ON Semiconductor®



SCALE 2:1

Micro8 CASE 846A-02 ISSUE K

DATE 16 JUL 2020

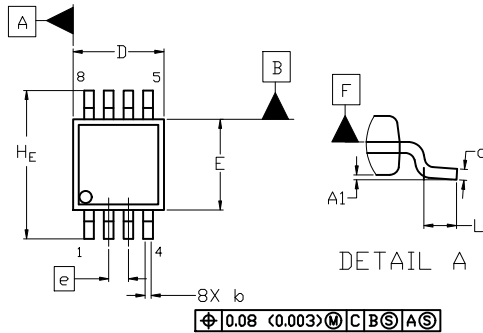

TOP VIEW

NOTE 3

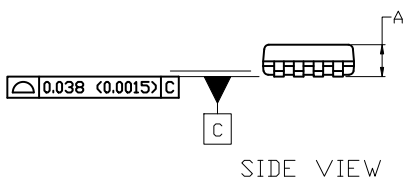

SIDE VIEW

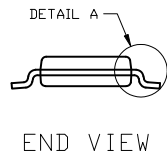

END VIEW

NOTES:

1. DIMENSIONING AND TOLERANCING PER ASME Y14.5M, 2009.
2. CONTROLLING DIMENSION: MILLIMETERS
3. DIMENSION *b* DOES NOT INCLUDE DAMBAR PROTRUSION. ALLOWABLE PROTRUSION SHALL BE 0.10 mm IN EXCESS OF MAXIMUM MATERIAL CONDITION.
4. DIMENSIONS D AND E DO NOT INCLUDE MOLD FLASH, PROTRUSION OR GATE BURRS. MOLD FLASH, PROTRUSIONS, OR GATE BURRS SHALL NOT EXCEED 0.15 mm PER SIDE. DIMENSION E DOES NOT INCLUDE INTERLEAD FLASH OR PROTRUSION. INTERLEAD FLASH OR PROTRUSION SHALL NOT EXCEED 0.25 mm PER SIDE. DIMENSIONS D AND E ARE DETERMINED AT DATUM F.
5. DATUMS A AND B ARE TO BE DETERMINED AT DATUM F.
6. A1 IS DEFINED AS THE VERTICAL DISTANCE FROM THE SEATING PLANE TO THE LOWEST POINT ON THE PACKAGE BODY.

$\phi 0.08$ (0.003) M C B S A S

DIM	MILLIMETERS		
	MIN.	NOM.	MAX.
A	---	---	1.10
A1	0.05	0.08	0.15
<i>b</i>	0.25	0.33	0.40
<i>c</i>	0.13	0.18	0.23
D	2.90	3.00	3.10
E	2.90	3.00	3.10
<i>e</i>	0.65 BSC		
H _E	4.75	4.90	5.05
L	0.40	0.55	0.70

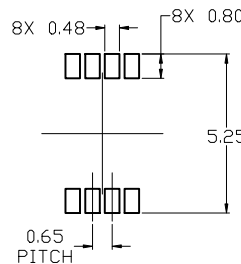

RECOMMENDED MOUNTING FOOTPRINT

For additional information on our Pb-Free strategy and soldering details, please download the ON Semiconductor Soldering and Mounting Techniques Reference Manual, SOLDERM/D.

GENERIC MARKING DIAGRAM*

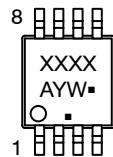

- XXXX = Specific Device Code
- A = Assembly Location
- Y = Year
- W = Work Week
- = Pb-Free Package

(Note: Microdot may be in either location)

*This information is generic. Please refer to device data sheet for actual part marking. Pb-Free indicator, "G" or microdot "▪", may or may not be present. Some products may not follow the Generic Marking.

STYLE 1:

1. SOURCE
2. SOURCE
3. SOURCE
4. GATE
5. DRAIN
6. DRAIN
7. DRAIN
8. DRAIN

STYLE 2:

1. SOURCE 1
2. GATE 1
3. SOURCE 2
4. GATE 2
5. DRAIN 2
6. DRAIN 2
7. DRAIN 1
8. DRAIN 1

STYLE 3:

1. N-SOURCE
2. N-GATE
3. P-SOURCE
4. P-GATE
5. P-DRAIN
6. P-DRAIN
7. N-DRAIN
8. N-DRAIN

DOCUMENT NUMBER:	98ASB14087C	Electronic versions are uncontrolled except when accessed directly from the Document Repository. Printed versions are uncontrolled except when stamped "CONTROLLED COPY" in red.
DESCRIPTION:	MICRO8	PAGE 1 OF 1

ON Semiconductor and ON are trademarks of Semiconductor Components Industries, LLC dba ON Semiconductor or its subsidiaries in the United States and/or other countries. ON Semiconductor reserves the right to make changes without further notice to any products herein. ON Semiconductor makes no warranty, representation or guarantee regarding the suitability of its products for any particular purpose, nor does ON Semiconductor assume any liability arising out of the application or use of any product or circuit, and specifically disclaims any and all liability, including without limitation special, consequential or incidental damages. ON Semiconductor does not convey any license under its patent rights nor the rights of others.

onsemi, **Onsemi**, and other names, marks, and brands are registered and/or common law trademarks of Semiconductor Components Industries, LLC dba "**onsemi**" or its affiliates and/or subsidiaries in the United States and/or other countries. **onsemi** owns the rights to a number of patents, trademarks, copyrights, trade secrets, and other intellectual property. A listing of **onsemi**'s product/patent coverage may be accessed at www.onsemi.com/site/pdf/Patent-Marking.pdf. **onsemi** reserves the right to make changes at any time to any products or information herein, without notice. The information herein is provided "as-is" and **onsemi** makes no warranty, representation or guarantee regarding the accuracy of the information, product features, availability, functionality, or suitability of its products for any particular purpose, nor does **onsemi** assume any liability arising out of the application or use of any product or circuit, and specifically disclaims any and all liability, including without limitation special, consequential or incidental damages. Buyer is responsible for its products and applications using **onsemi** products, including compliance with all laws, regulations and safety requirements or standards, regardless of any support or applications information provided by **onsemi**. "Typical" parameters which may be provided in **onsemi** data sheets and/or specifications can and do vary in different applications and actual performance may vary over time. All operating parameters, including "Typicals" must be validated for each customer application by customer's technical experts. **onsemi** does not convey any license under any of its intellectual property rights nor the rights of others. **onsemi** products are not designed, intended, or authorized for use as a critical component in life support systems or any FDA Class 3 medical devices or medical devices with a same or similar classification in a foreign jurisdiction or any devices intended for implantation in the human body. Should Buyer purchase or use **onsemi** products for any such unintended or unauthorized application, Buyer shall indemnify and hold **onsemi** and its officers, employees, subsidiaries, affiliates, and distributors harmless against all claims, costs, damages, and expenses, and reasonable attorney fees arising out of, directly or indirectly, any claim of personal injury or death associated with such unintended or unauthorized use, even if such claim alleges that **onsemi** was negligent regarding the design or manufacture of the part. **onsemi** is an Equal Opportunity/Affirmative Action Employer. This literature is subject to all applicable copyright laws and is not for resale in any manner.

ADDITIONAL INFORMATION

TECHNICAL PUBLICATIONS:

Technical Library: www.onsemi.com/design/resources/technical-documentation
onsemi Website: www.onsemi.com

ONLINE SUPPORT: www.onsemi.com/support

For additional information, please contact your local Sales Representative at www.onsemi.com/support/sales

Looking for pricing, stock, or lifecycle information?

Click below to explore more details on WIN SOURCE:

- ⊖ [View NCP2890DMR2](#) on WIN SOURCE
- ⊖ [ON Semiconductor](#) Information

Optimize Your Supply Chain with WIN SOURCE Solutions

- ✓ Global Sourcing Solution
- ✓ Obsolete Management
- ✓ Cost Control Management
- ✓ Shortage Management
- ✓ Alternative Solution
- ✓ Excess Inventory Management