



THE DATASHEET OF
1010





SMT & THM POLARIZED "CR2" • "CR123A" CELL HOLDERS

FEATURES

- Battery installation and removal does not require tools.
- UL 94V-0 Heat resistant Nylon Housings well suited for reflow or wave soldering.
- Securely holds battery in place
- Polarized holder offers circuit protection against improper battery installation

APPLICATIONS

- Computer memory, power backup systems
- Telecommunications/Security Systems
- PLC and industrial controls

SPECIFICATIONS

Base: High Temp Nylon 46, UL Rated 94V-0

Contacts: .012 (.30) Stainless Steel, Gold Plate (Flash) - SMT

Contacts: .012 (.30) Stainless Steel, Tin-Nickel Plate - THM

Operating temp range: -60°F to 290°F (-50°C to 145°C)

THM

SMT

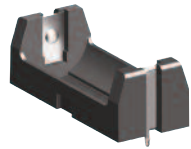

Thru-Hole Mount (THM)

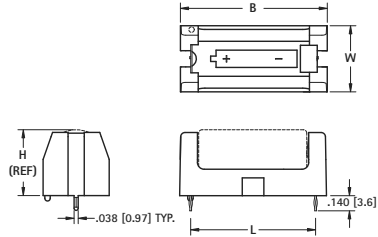

Mounting Detail

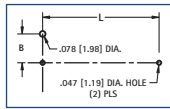

1018C
RETAINER
COVER
FITS ALL
HOLDERS

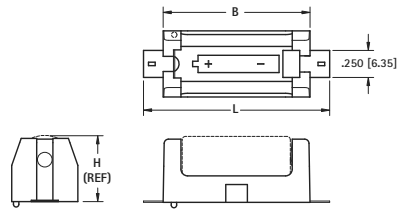

Surface Mount (SMT)

Mounting Detail

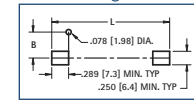

CAT. NO.	MOUNTING STYLE	L	W	H (Ref)	B	G	CELL SIZE	PACKAGING SPEC'S
1010	SMT	1.723 (43.8)	.612 (15.5)	.661 (16.8)	1.360 (34.5)	.265 (6.7)	CR2	50 pieces per tray
1011	THM	1.156 (29.4)	.612 (15.5)	.661 (16.8)	1.360 (34.5)	.265 (6.7)	CR2	
1050	SMT	2.062 (52.4)	.720 (18.3)	.712 (18.1)	1.690 (42.9)	.319 (8.1)	CR123A	
1051	THM	1.487 (37.8)	.720 (18.3)	.712 (18.1)	1.690 (42.9)	.319 (8.1)	CR123A	

SMT & THM DUAL POLARIZED CR123A CELL HOLDER

THM

SMT

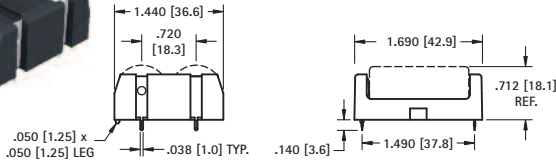

Mounting Detail

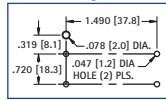

CAT. NO. 1079

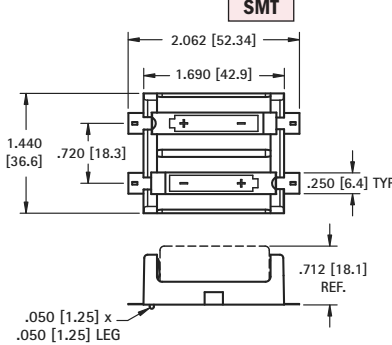

Mounting Detail

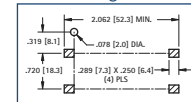

CAT. NO. 1080

Packaging Spec's: 25 pieces per tray

SMT & INLINE "26650" LITHIUM-ION HOLDERS

SINGLE

DUAL

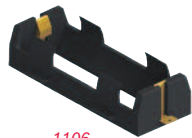

1106
SMT



1107
Solder Lugs

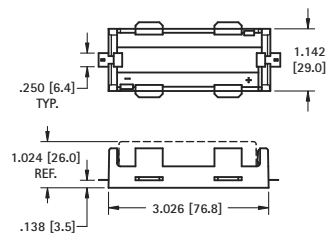

DWG. 1 SMT version shown



• Thru board design saves on total product height.

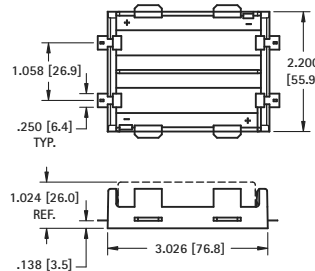

DWG. 2 SMT version shown



1108
SMT

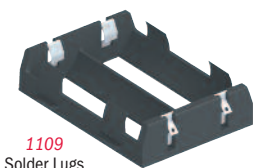

1109
Solder Lugs

Mounting Detail

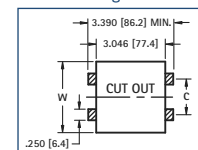

SPECIFICATIONS

SMT Base: High Temperature Nylon 4/6, UL Rated 94V-0

SMT Contacts: .012 (.03) Stainless Steel, Gold Plate (Flash)

Inline Base: PBT, UL Rated 94V-0



Inline Solder Lugs: .012 (.3) Stainless Steel, Nickel Plate

CAT. NO.	MTG.	FIG. NO.	HOLDS NO. OF CELLS	SMT MOUNTING PAD LAYOUT	
				W	C
1107	Solder Lugs	1	1	-	-
1109		2	2	-	-
1106	SMT	1	1	1.142 (29.0)	On Center
1108		2	2	2.200 (55.9)	1.058 (26.9)



Looking for pricing, stock, or lifecycle information?

Click below to explore more details on WIN SOURCE:

-  [View 1010 on WIN SOURCE](#)
-  [Keystone Electronics Information](#)

Optimize Your Supply Chain with WIN SOURCE Solutions

-  Global Sourcing Solution
-  Obsolete Management
-  Cost Control Management
-  Shortage Management
-  Alternative Solution
-  Excess Inventory Management