



**THE DATASHEET OF
CPDQC24VE-HF**



CPDQC24VE-HF

RoHS Device

Halogen Free



Features

- Bi-directional ESD protection.
- IEC 61000-4-2 (ESD) ; $\pm 30\text{KV}$ (contact)
- Surface mount package.
- Ultra small SMD package: 0402C
- High component density.

Mechanical data

- Case: 0402C/SOD-923F package, molded plastic.
- Terminals: Gold plated, solderable per MIL-STD-750,method 2026.
- Mounting position: Any.
- Weight: 0.001 grams(approx.).

Circuit Diagram

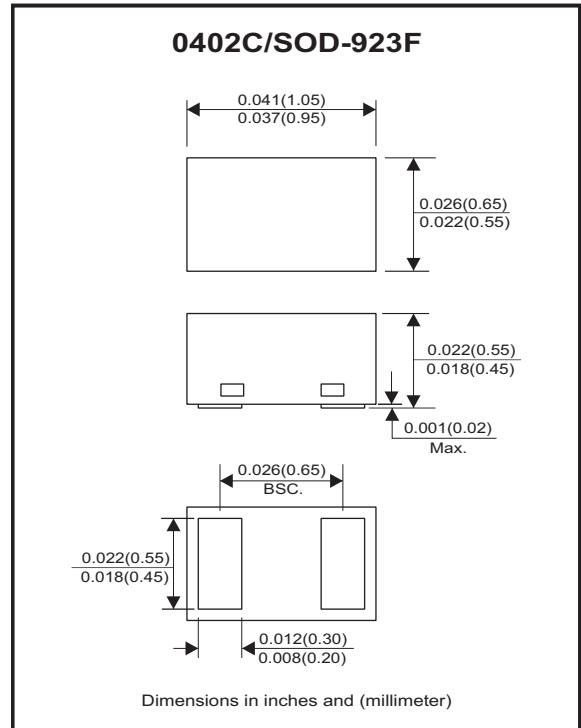

Maximum Rating (at $T_A=25^\circ\text{C}$ unless otherwise noted)

Parameter	Conditions	Symbol	Value	Unit
Peak pulse power	$T_P = 8/20\mu\text{s}$	P_{PP}	138	W
Peak pulse current	$T_P = 8/20\mu\text{s}$	I_{PP}	3	A
ESD capability	IEC 61000-4-2(air) IEC 61000-4-2(contact)	ESD	± 30	kV
Operation temperature range		T_j	-55~+125	$^\circ\text{C}$
Storage temperature range		T_{STG}	-55~+150	$^\circ\text{C}$

Electrical Characteristics (at $T_A=25^\circ\text{C}$ unless otherwise noted)

Parameter	Conditions	Symbol	Min	Typ	Max	Unit
Working peak reverse voltage		V_{RWM}			24	V
Breakdown voltage	$I_T = 1\text{mA}$	V_{BR}	26.5	29	32	V
Reverse leakage current	$V_{RWM} = 24\text{V}$	I_R			100	nA
Clamping voltage	$I_{PP} = 1\text{A}, T_P = 8/20\mu\text{s}$ $I_{PP} = 3\text{A}, T_P = 8/20\mu\text{s}$	V_C		32 38	36 46	V
Junction capacitance	$V_R = 0\text{V}, f = 1\text{MHz}$	C_J		13	20	pF

RATING AND CHARACTERISTIC CURVES (CPDQC24VE-HF)

Fig.1 - 8/20us Peak Pulse Current Wave Form ACC. IEC 61000-4-5

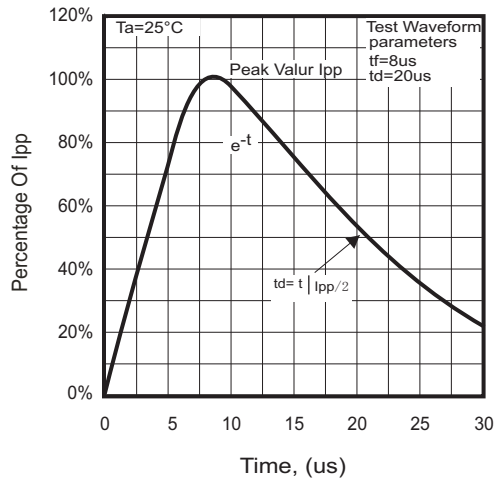

Fig.2 - Power rating derating curve

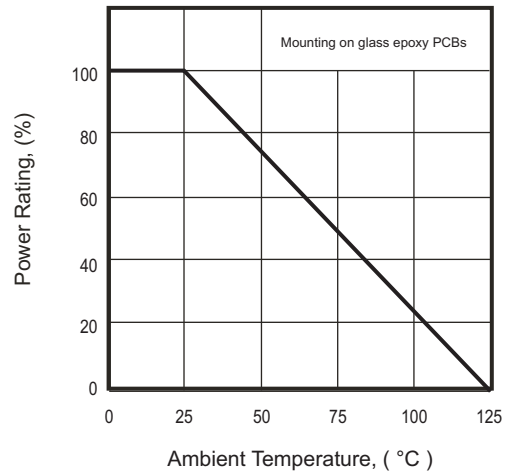

Fig. 3 - Clamping Voltage Vs. Peak Pulse Current

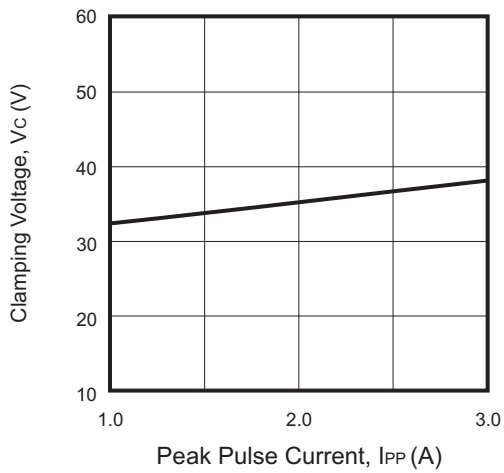
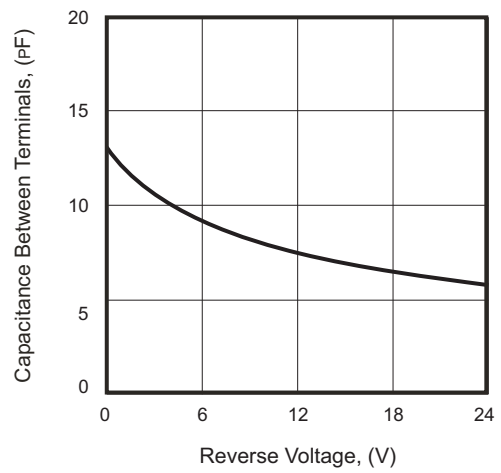
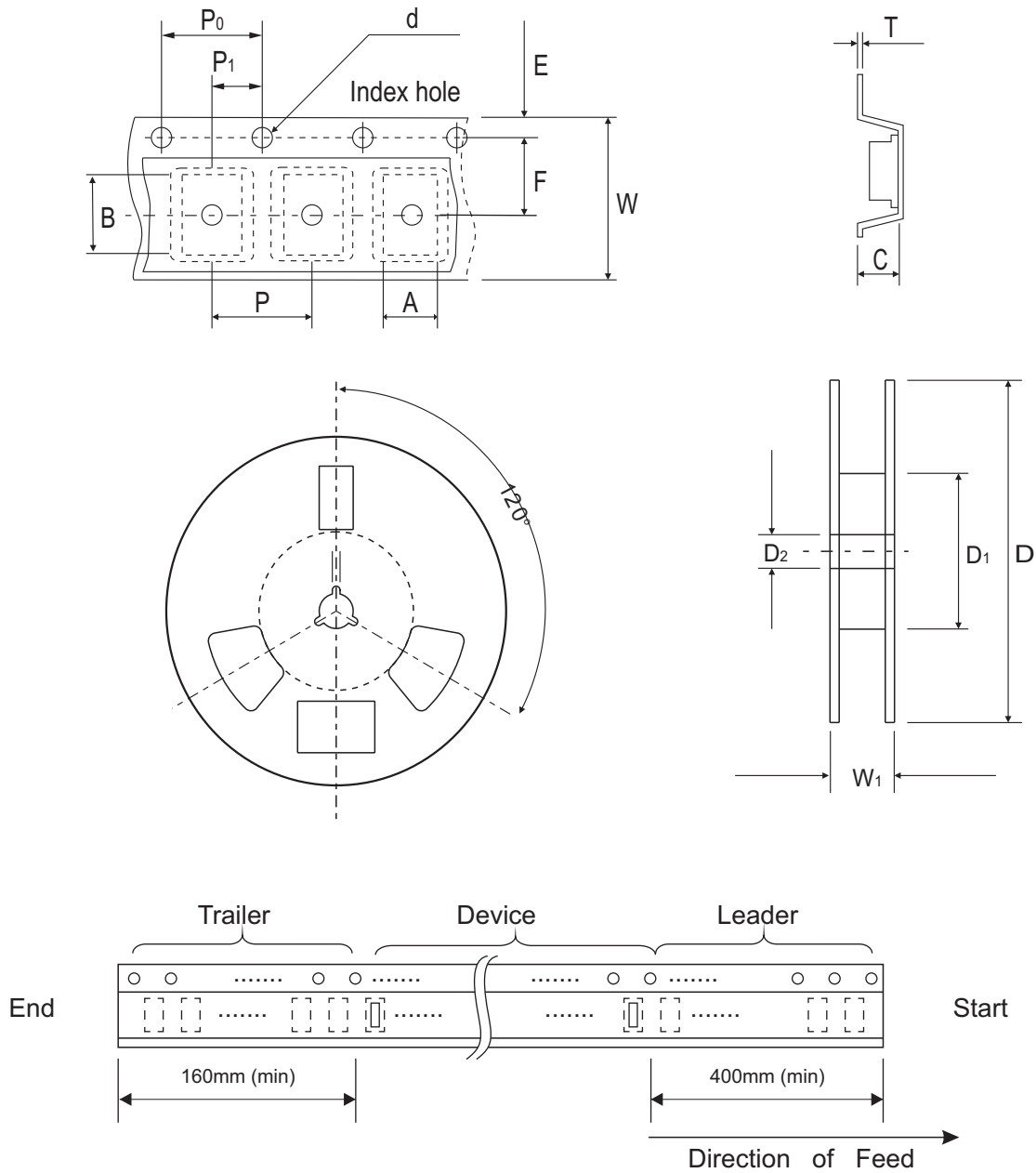

Fig.4 - Capacitance Between Terminals Characteristics



Reel Taping Specification



0402C (SOD-923F)	SYMBOL	A	B	C	d	D	D ₁	D ₂
	(mm)	0.75 ± 0.05	1.17 ± 0.05	0.65 ± 0.05	1.50 + 0.10 - 0	178.00 ± 1.00	60.00 ± 0.50	13.50 ± 0.20
	(inch)	0.030 ± 0.002	0.046 ± 0.002	0.026 ± 0.002	0.059 + 0.004 - 0	7.008 ± 0.039	2.362 ± 0.002	0.531 ± 0.008

0402C (SOD-923F)	SYMBOL	E	F	P	P ₀	P ₁	T	W	W ₁
	(mm)	1.75 ± 0.10	3.50 ± 0.10	4.00 ± 0.10	4.00 ± 0.10	2.00 ± 0.10	0.20 + 0.02 - 0.05	8.00 ± 0.20	12.00 + 0.50 - 0
	(inch)	0.069 ± 0.004	0.138 ± 0.004	0.157 ± 0.004	0.157 ± 0.004	0.079 ± 0.004	0.008 + 0.001 - 0.002	0.315 ± 0.008	0.472 + 0.020 - 0

Marking Code

Part Number	Marking Code
CPDQC24VE-HF	E4



Suggested PAD Layout

SIZE	0402C/SOD-923F	
	(mm)	(inch)
A	0.70	0.028
B	0.40	0.016
C	0.60	0.024
D	1.10	0.043
E	0.30	0.012

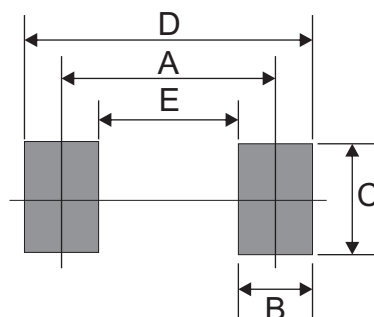



Standard Packaging

Case Type	REEL PACK	
	REEL (pcs)	Reel Size (inch)
0402C/SOD-923F	5,000	7

Looking for pricing, stock, or lifecycle information?

Click below to explore more details on WIN SOURCE:

-  [View CPDQC24VE-HF](#) on WIN SOURCE
-  [Comchip Technology](#) Information

Optimize Your Supply Chain with WIN SOURCE Solutions

-  Global Sourcing Solution
-  Obsolete Management
-  Cost Control Management
-  Shortage Management
-  Alternative Solution
-  Excess Inventory Management