

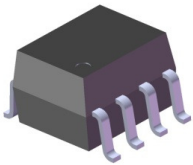

THE DATASHEET OF ELD206



8 PIN SOP PHOTOTRANSISTOR DUAL CHANNEL PHOTOCOUPLER ELD20X Series ELD21X Series



Features:

- Dual channel coupler
- Current transfer ratios offered in narrow ranges

ELD205: 40-80%	ELD211: >20%
ELD206: 63-125%	ELD213: >100%
ELD207: 100-200%	ELD217: >100%
- High isolation voltage between input and output
Viso = 3750 Vrms
- Operating temperature range of -55 to +110°C
- High BVceo of 80V
- Standard SO-8 footprint package
- Pb free and RoHS compliant.
- UL approved (No. E214129)
- VDE approval (No. 40028116)
- SEMKO approved
- NEMKO approved
- DEMKO approved
- FIMKO approved
- CSA approved (No. 2007189)

Schematic

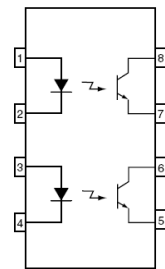

Pin Configuration

1. Anode
2. Cathode
3. Anode
4. Cathode
5. Emitter
6. Collector
7. Emitter
8. Collector

Description

The ELD20X and ELD21X series contain two infrared emitting diodes optically coupled to two phototransistor detectors.

The devices are packaged in an 8-pin small outline package which conforms to the standard SO-8 footprint.

Applications

- Feedback Control Circuits
- Interfacing and coupling systems of different potentials and impedances
- General Purpose Switching Circuits
- Monitor and Detection Circuits

Absolute Maximum Ratings (Ta=25°C)

	Parameter	Symbol	Rating	Unit
Input	Forward current	I_F	60	mA
	Peak forward current (t = 10μs)	I_{FM}	1	A
	Reverse voltage	V_R	6	V
	Power dissipation No derating needed	P_D	90	mW
Output	Collector power dissipation No derating needed	P_C	150	mW
	Collector-Emitter voltage	V_{CEO}	80	V
	Collector-Base voltage	V_{CBO}	80	V
	Emitter-Collector voltage	V_{ECO}	7	V
	Collector Current	I_C	50	mA
	Total Power Dissipation	P_{TOT}	250	mW
	Isolation Voltage* ¹	V_{ISO}	3750	V rms
	Operating Temperature	T_{OPR}	-55 to 110	°C
	Storage Temperature	T_{STG}	-55 to 125	°C
	Soldering Temperature* ²	T_{SOL}	260	°C

Notes:

*1 AC for 1 minute, R.H.= 40 ~ 60% R.H. In this test, pins 1, 2, 3 & 4 are shorted together, and pins 5, 6, 7 & 8 are shorted together.

*2 For 10 seconds

Electro-Optical Characteristics (Ta=25°C unless specified otherwise)

Input

Parameter	Symbol	Min.	Typ.	Max.	Unit	Condition
Forward voltage	V_F	-	1.2	1.5	V	$I_F = 10\text{mA}$
Reverse current	I_R	-	0.1	100	μA	$V_R = 6\text{V}$
Input capacitance	C_{in}	-	25	-	pF	$V = 0, f = 1\text{MHz}$

Output

Parameter	Symbol	Min	Typ.	Max.	Unit	Condition
Collector-Emitter dark current	I_{CEO}	-	5.0	50	nA	$V_{CE} = 10\text{V}, I_F = 0\text{mA}$
Collector-Emitter breakdown voltage	BV_{CEO}	80	-	-	V	$I_C = 0.1\text{mA}$
Emitter-Collector breakdown voltage	BV_{ECO}	7	-	-	V	$I_E = 0.1\text{mA}$
Collector-Emitter capacitance	C_{CE}	-	10	-	pF	$V_{CE} = 0\text{V}, f = 1\text{MHz}$

Transfer Characteristics

Parameter	Symbol	Min	Typ.	Max.	Unit	Condition
Current Transfer Ratio	ELD205	40	-	80	%	$I_F = 10\text{mA}, V_{CE} = 5\text{V}$
	ELD206	63	-	125		
	ELD207	100	-	200		
	ELD211	20	-	-		
	ELD213	100	-	-		
Current Transfer Ratio	ELD205	13	30	-	%	$I_F = 1\text{mA}, V_{CE} = 5\text{V}$
	ELD206	22	45	-		
	ELD207	34	70	-		
	ELD217	100	120	-		

* Typical values at $T_a = 25^\circ\text{C}$

Transfer Characteristics

Parameter	Symbol	Min	Typ.	Max.	Unit	Condition
Collector-emitter saturation voltage	$V_{CE(sat)}$	-	-	0.4	V	$I_F = 10mA, I_C = 2.5mA$
Isolation resistance	R_{IO}	-	10^{11}	-	Ω	$V_{IO} = 500Vdc$
Input-output capacitance	C_{IO}	-	0.5	-	pF	$V_{IO} = 0, f = 1MHz$
Turn-on time	T_{on}	-	5.0	-	μs	$V_{CC} = 10V, I_C = 2mA, R_L = 100\Omega$
Turn-off time	T_{off}	-	4.0	-		
Rise time	T_r	-	1.6	-		
Fall time	T_f	-	2.2	-		

* Typical values at $T_a = 25^\circ C$

Typical Electro-Optical Characteristics Curves

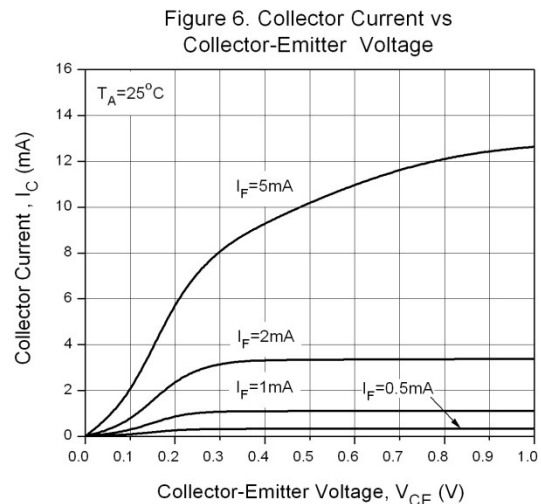
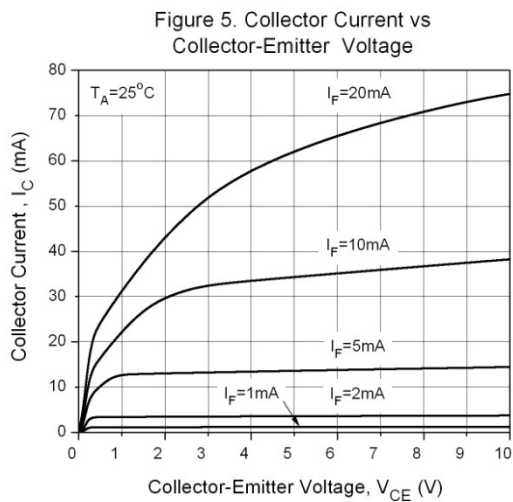
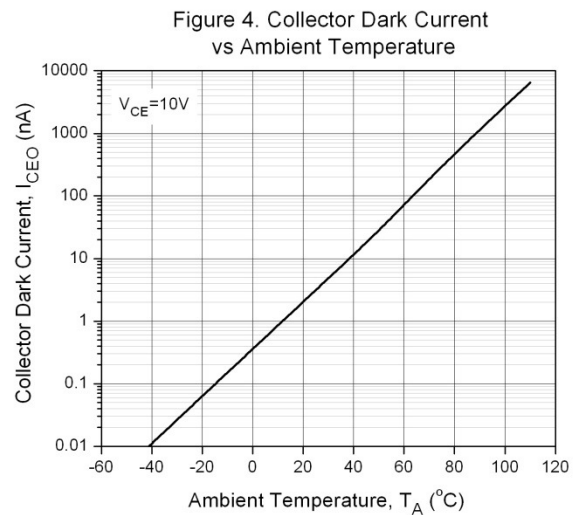
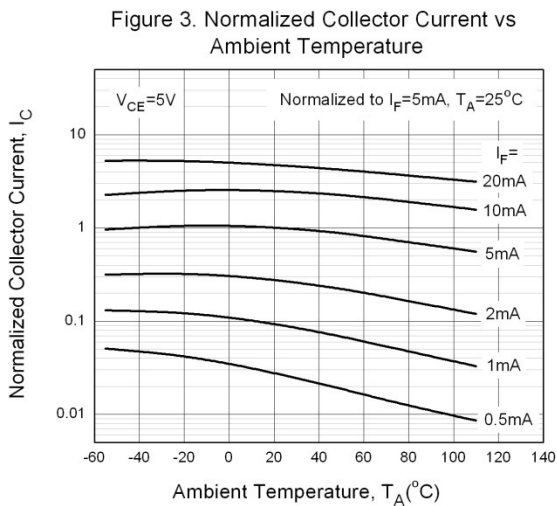
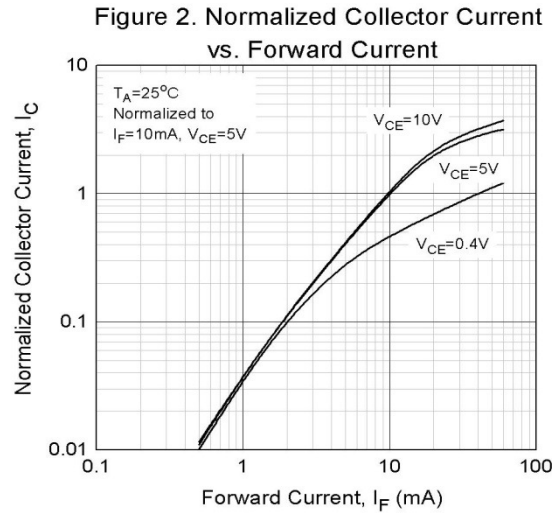
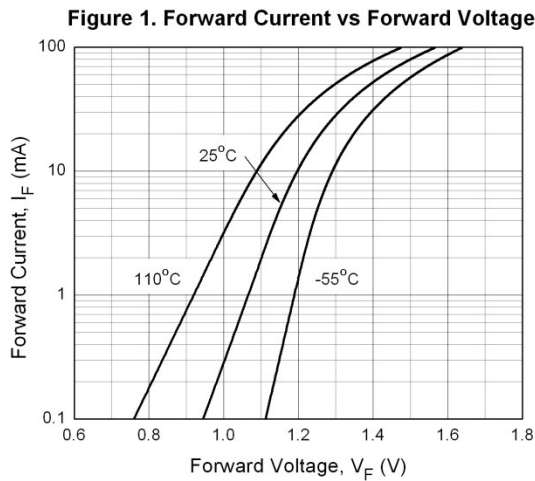

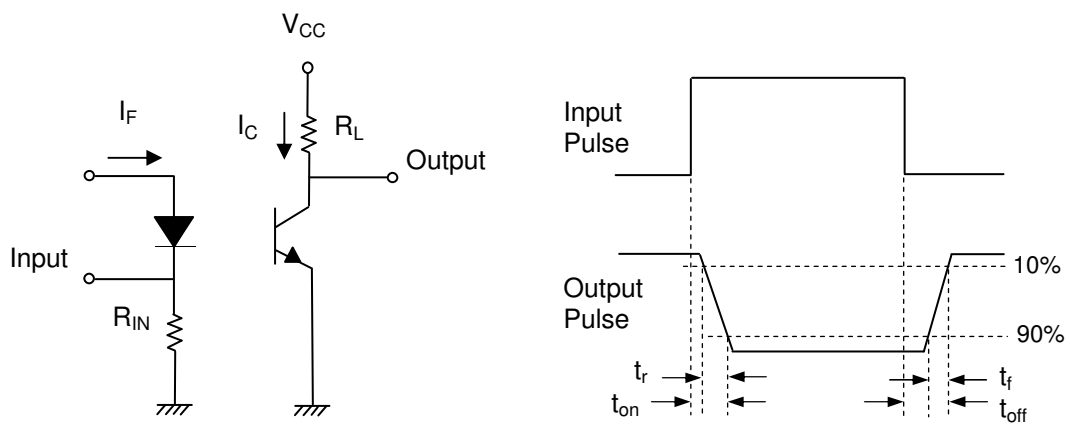
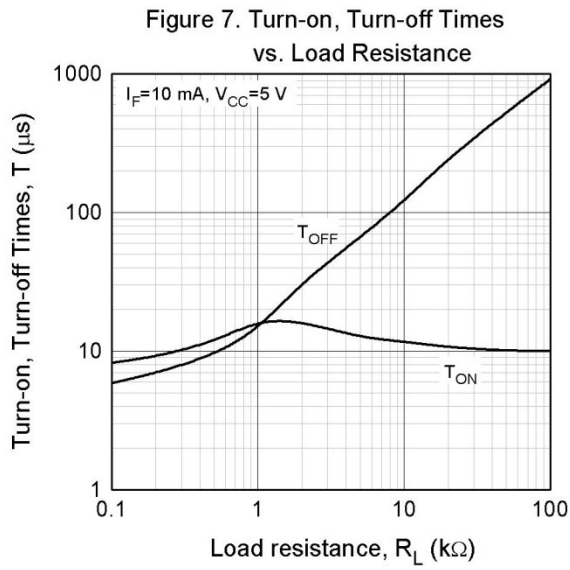

Figure 8. Switching Time Test Circuit & Waveforms

Order Information

Part Number

ELD2XX(Y)-V

Note

XX = Part no. (05, 06, 07, 11, 13, or 17)

Y = Tape and reel option (TA, TB or none).

V = VDE safety (Optional)

Option	Description	Packing quantity
None	Standard	100 units per tube
-V	Standard + VDE	100 units per tube
(TA)	TA tape & reel option	2000 units per reel
(TB)	TB tape & reel option	2000 units per reel
(TA)-V	TA tape & reel option + VDE	2000 units per reel
(TB)-V	TB tape & reel option + VDE	2000 units per reel

Package Dimension (Dimensions in mm)

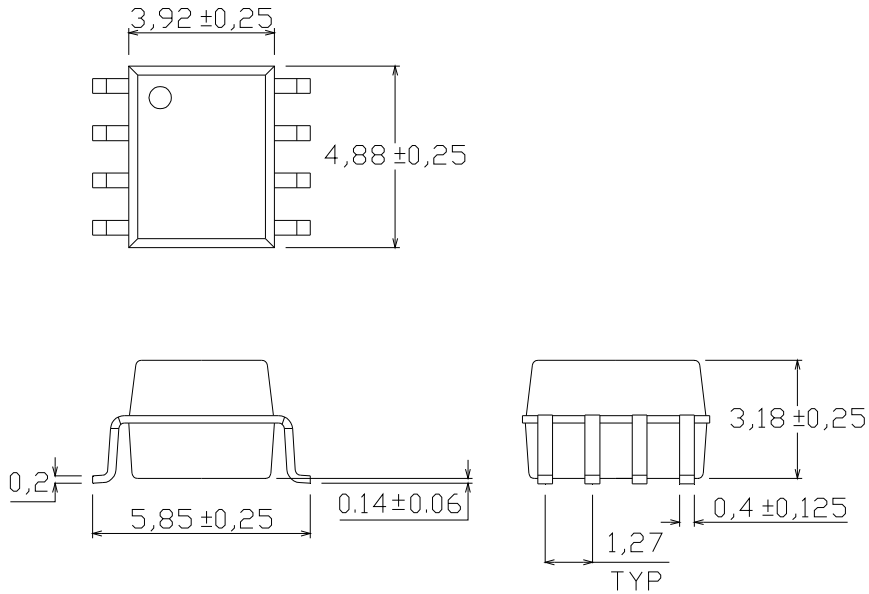

Recommended pad layout for surface mount leadform

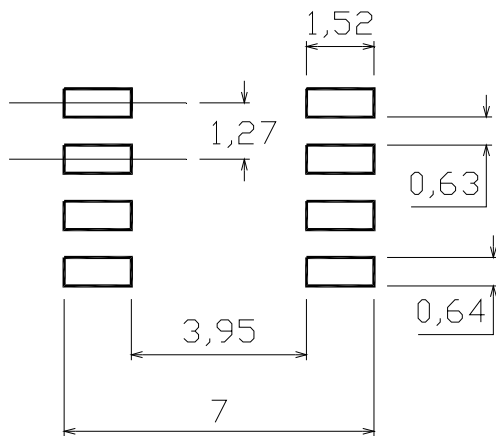

Device Marking

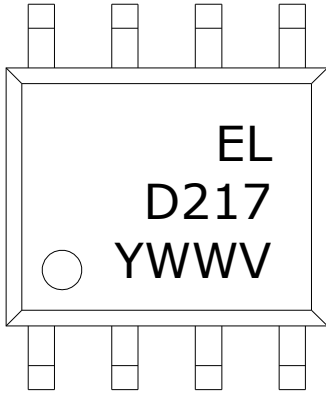

Notes

EL	denotes Everlight
D217	denotes Part Number
Y	denotes 1 digit Year code
WW	denotes 2 digit Week code

Tape & Reel Packing Specifications

Option TA

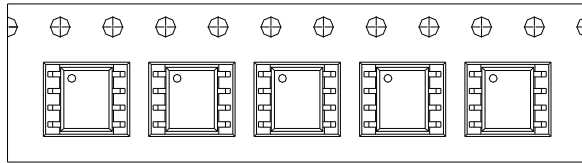

Option TB

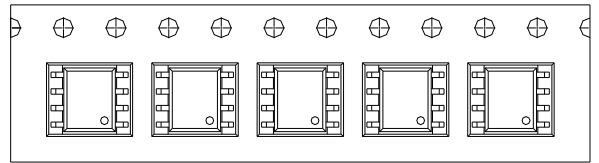

Direction of feed from reel

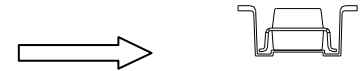

Direction of feed from reel

Tape dimensions

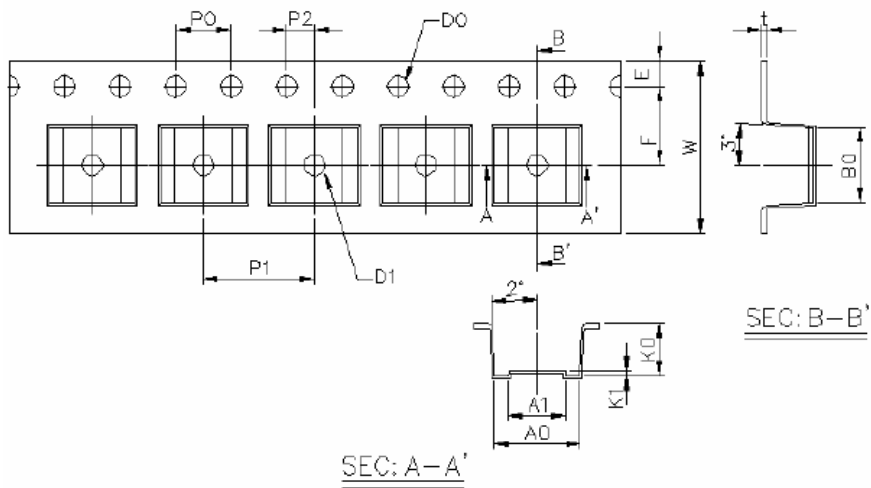

Dimension No.	A0	A1	B0	D0	D1	E	F
Dimension (mm)	6.2±0.1	4.1±0.1	5.28±0.1	1.5±0.1	1.5±0.3	1.75±0.1	5.5±0.1
Dimension No.	Po	P1	P2	t	W	K0	K1
Dimension (mm)	4.0±0.1	8.0±0.1	2.0±0.1	0.4±0.1	12.0+0.3/ -0.1	3.7±0.1	0.3±0.1

Precautions for Use

1. Soldering Condition

1.1 (A) Maximum Body Case Temperature Profile for evaluation of Reflow Profile

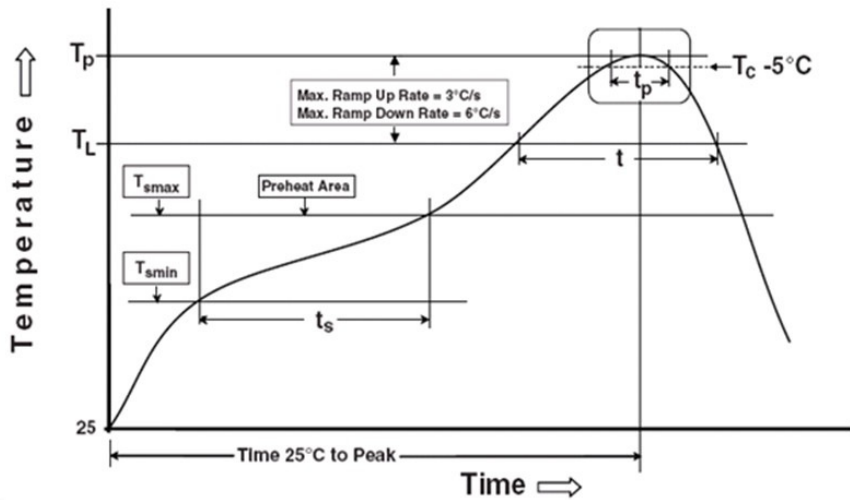

Note:

Reference: IPC/JEDEC J-STD-020D

Preheat

Temperature min (T_{smin})	150 °C
Temperature max (T_{smax})	200 °C
Time (T_{smin} to T_{smax}) (t_s)	60-120 seconds
Average ramp-up rate (T_{smax} to T_p)	3 °C/second max

Other



Liquidus Temperature (T_L)	217 °C
Time above Liquidus Temperature (t_L)	60-100 sec
Peak Temperature (T_p)	260 °C
Time within 5 °C of Actual Peak Temperature: $T_p - 5^\circ C$	30 s
Ramp- Down Rate from Peak Temperature	6 °C /second max.
Time 25°C to peak temperature	8 minutes max.
Reflow times	3 times

DISCLAIMER

1. Above specification may be changed without notice. EVERLIGHT will reserve authority on material change for above specification.
2. When using this product, please observe the absolute maximum ratings and the instructions for using outlined in these specification sheets. EVERLIGHT assumes no responsibility for any damage resulting from use of the product which does not comply with the absolute maximum ratings and the instructions included in these specification sheets.
3. These specification sheets include materials protected under copyright of EVERLIGHT corporation. Please don't reproduce or cause anyone to reproduce them without EVERLIGHT's consent.

Looking for pricing, stock, or lifecycle information?

Click below to explore more details on WIN SOURCE:

-  [View ELD206 on WIN SOURCE](#)
-  [Everlight Electronics Co Ltd Information](#)

Optimize Your Supply Chain with WIN SOURCE Solutions

-  Global Sourcing Solution
-  Obsolete Management
-  Cost Control Management
-  Shortage Management
-  Alternative Solution
-  Excess Inventory Management