



**THE DATASHEET OF  
F1206A2R00FWTR**



### ACCU-GUARD® TECHNOLOGY

The Accu-Guard® series of fuses is based on thin-film techniques. This technology provides a level of control on the component electrical and physical characteristics that is generally not possible with standard fuse technologies. This has allowed AVX to offer a series of devices which are designed for modern surface mount circuit boards which require protection.

### FEATURES

- Accurate current rating
- Fast acting
- Small-standard 0402, 0603, 0805, 1206 and 0612 chip sizes
- Taped and reeled
- Completely compatible with all soldering systems used for SMT
- Lead Free Series (F0402E, F0402G, F0603E, F0805B, F1206B)

### APPLICATIONS

- Cellular Telephones
- Two-Way Radios
- Computers
- Battery Chargers
- Rechargeable Battery Packs
- Hard Disk Drives
- PDA's
- LCD Screens
- SCSI Interface
- Digital Cameras
- Video Cameras

### APPROVAL FILE NUMBERS

- UL, cUL: RCD#E143842
- UL (F0402G): RCD#E141069

### DIMENSIONS millimeters (inches)

F0603C, F0805B, F1206A and F1206B

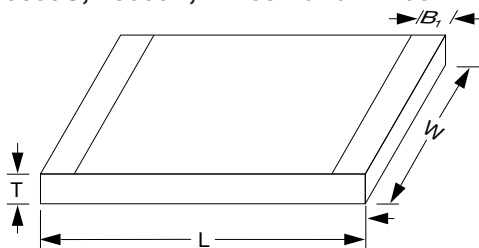

F0402E and F0603E

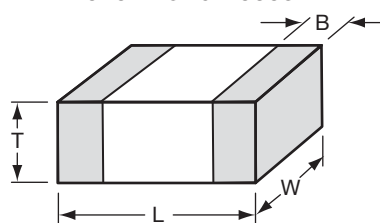

F0402G

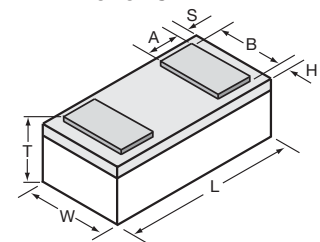

	F0402G	F0402E	F0603E	F0603C	F0805B	F1206A/B	F0612D
<b>L</b>	1.00±0.05 (0.039±0.002)	1.00±0.10 (0.039±0.004)	1.60±0.10 (0.063±0.004)	1.65±0.25 (0.065±0.010)	2.1±0.2 (0.083±0.008)	3.1±0.2 (0.122±0.008)	1.65±0.25 (0.065±0.010)
<b>W</b>	0.58±0.04 (0.023±0.002)	0.55±0.07 (0.022±0.003)	0.81±0.10 (0.032±0.004)	0.80±0.15 (0.031±0.006)	1.27±0.1 (0.050±0.004)	1.6±0.1 (0.063±0.004)	3.1±0.2 (0.122±0.008)
<b>T</b>	0.35±0.05 (0.014±0.002)	0.40±0.10 (0.016±0.004)	0.63±0.10 (0.025±0.004)	0.90±0.2 (0.035±0.008)	0.90±0.2 (0.035±0.008)	1.2±0.2 (0.047±0.008)	0.90±0.2 (0.036±0.008)
<b>B</b>	0.48±0.05 (0.019±0.002)	0.20±0.10 (0.008±0.004)	0.35±0.15 (0.014±0.006)	0.35±0.15 (0.014±0.006)	0.30±0.15 (0.012±0.006)	0.43±0.25 (0.017±0.010)	0.35±0.15 (0.014±0.006)
<b>A</b>	0.20±0.05 (0.008±0.002)						
<b>S, H</b>	0.05±0.05 (0.002±0.002)						

### HOW TO ORDER

**F**  
Product  
Fuse

**1206**  
Size  
See table for  
standard sizes

**A**  
Fuse Version  
A=Accu-Guard®  
B=Accu-Guard® II  
C=Accu-Guard® II  
0603  
D=Accu-Guard® II  
0612  
E=Accu-Guard® II  
0402, 0603  
G=Accu-Guard® II  
0402 Low Current

**0R20**  
Rated Current  
Current expressed in  
Amps. Letter R  
denotes decimal  
point. e.g.  
0.20A=0R20  
1.75A=1R75

**F**  
Fuse Speed  
F=Fast

**W**  
Termination  
S=Nickel/Lead-  
Free Solder  
coated  
(Sn 100)  
W=Nickel/solder  
coated  
(Sn 63, Pb 37)

**TR**  
Packaging  
TR=Tape and reel

## SMD Thin-Film Fuse

Accu-Guard® II is a version of Accu-Guard® fuses for a wider range of current and voltage ratings. Constructed on alumina substrates, Accu-Guard® II fuses display superior electrical, mechanical and environmental properties. Accu-Guard® II dimensions are standard 0402, 0603, 0805, 1206 and 0612 chip sizes, see page 2.

### ELECTRICAL SPECIFICATIONS

Operating temperature: -55°C to +125°C

Current carrying capacity:

For F0402E and F0603E at -55°C 107% of rating, at -25°C 100% of rating, at +125°C 80% of rating. For F0603C at -55°C is 107% of rating, at +25°C 100% of rating, at +85°C 90% of rating, at +125°C 75% of rating.

For F1206B and F0805B at -55°C is 107% of rating, at +25°C 100% of rating, at +85°C 93% of rating, at +125°C 90% of rating. For F0805B 2.50A and 3.00A at +85°C 90% of rating, at +125°C 90% of rating.

Interrupting rating: 50A.

Insulation resistance: >20MΩ guaranteed (after fusing at rated voltage).

For F0612D at -55°C 107% of rating, at +25°C 100% of rating, at +85°C 80% of rating, at +125°C 75% of rating.

Type	Part Number	Current Rating A	Resistance 10% x I rated, 25°C Ω (max.)	Voltage Drop @1 x I rated, 25°C mV (max.)	Fusing Current (within 5 sec), 25°C A	Pre-Arc I <sup>2</sup> t @ 50A A <sup>2</sup> -sec	Rated Voltage V
F0402E	F0402E0R25FSTR	0.25	0.650	220	0.625	0.00005*	32
	F0402E0R50FSTR	0.50	0.250	180	1.25	0.0003	32
	F0402E0R75FSTR	0.75	0.200	180	1.875	0.003	32
	F0402E1R00FSTR	1.00	0.130	160	2.50	0.008	32
	F0402E1R50FSTR	1.50	0.060	140	3.75	0.03	32
F0603E	F0402E2R00FSTR	2.00	0.040	120	5.00	0.06	32
	F0603E0R25FSTR	0.25	0.650	220	0.625	0.00005*	32
	F0603E0R37FSTR	0.375	0.450	220	0.940	0.0001	32
	F0603E0R50FSTR	0.50	0.250	180	1.25	0.0003	32
	F0603E0R75FSTR	0.75	0.200	180	1.875	0.003	32
	F0603E1R00FSTR	1.00	0.130	160	2.50	0.008	32
	F0603E1R25FSTR	1.25	0.090	140	3.125	0.01	32
	F0603E1R50FSTR	1.50	0.060	140	3.75	0.03	32
	F0603E1R75FSTR	1.75	0.050	120	4.375	0.04	32
F0603C	F0603E2R00FSTR	2.00	0.040	120	5.00	0.06	32
	F0603E2R50FSTR	2.50	0.035	100	6.25	0.12	32
	F0603E3R00FSTR	3.00	0.030	100	7.50	0.25	32
	F0603C0R25FWTR	0.25	0.800	280	0.50	0.00003*	32
	F0603C0R37FWTR	0.375	0.500	280	0.75	0.0001	32
	F0603C0R50FWTR	0.50	0.320	280	1.00	0.0002	32
	F0603C0R75FWTR	0.75	0.300	280	1.50	0.0015	32
	F0603C1R00FWTR	1.00	0.200	240	2.00	0.004	32
	F0603C1R25FWTR	1.25	0.170	240	2.50	0.007	32
	F0603C1R50FWTR	1.50	0.110	240	3.00	0.012	32
F0805B	F0603C1R75FWTR	1.75	0.090	240	3.50	0.02	24
	F0603C2R00FWTR	2.00	0.075	240	4.00	0.03	24
	F0603C2R50FWTR	2.50	0.055	200	5.00	0.05	16
	F0603C3R00FWTR	3.00	0.045	200	6.00	0.1	16
	F0805B0R25FW/STR	0.25	0.750	280	0.50	0.00003*	63
	F0805B0R50FW/STR	0.50	0.350	280	1.00	0.0002	63
	F0805B0R75FW/STR	0.75	0.270	280	1.50	0.001	63
	F0805B1R00FW/STR	1.00	0.220	280	2.00	0.003	63
	F0805B1R25FW/STR	1.25	0.170	280	2.50	0.007	63
F1206B	F0805B1R50FW/STR	1.50	0.120	240	3.00	0.010	63
	F0805B2R00FW/STR	2.00	0.080	220	4.00	0.030	63
	F0805B2R50FW/STR	2.50	0.060	220	5.00	0.050	63
	F0805B3R00FW/STR	3.00	0.050	220	6.00	0.10	63
	F1206B0R25FW/STR	0.25	0.750	280	0.50	0.00003	63
	F1206B0R50FW/STR	0.50	0.350	280	1.00	0.0002	63
	F1206B1R00FW/STR	1.00	0.180	240	2.00	0.003	63
	F1206B1R50FW/STR	1.50	0.120	240	3.00	0.010	63
F0612D	F1206B2R00FW/STR	2.00	0.080	220	4.00	0.030	63
	F1206B3R00FW/STR	3.00	0.050	220	6.00	0.10	63
	F0612D4R00FWTR	4.00	0.040	260	10	0.10	32
	F0612D5R00FWTR	5.00	0.025	200	12.5	0.25	32

\*Current is limited to less than 50A at 32V due to internal fuse resistance.

### ENVIRONMENTAL CHARACTERISTICS

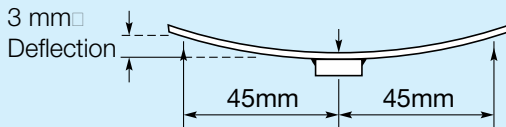
Test	Conditions	Requirement
Solderability	Components completely immersed in a solder bath at 235 ±5°C for 2 secs.	Terminations to be well tinned No visible damage
Leach Resistance	Completely immersed in a solder bath at 260 ±5°C for 60 secs.	Dissolution of termination ≤ 25% of area $\Delta R/R < 10\%$
Storage	12 months minimum with components stored in “as received” packaging.	Good solderability
Shear	Components mounted to a substrate. A force of 5N applied normal to the line joining the terminations and in a line parallel to the substrate.	No visible damage
Rapid Change of Temperature	Components mounted to a substrate. 50 cycles -55°C to +125°C.	No visible damage $\Delta R/R < 10\%$
Vibration	Per Mil-Std-202F Method 201A and Method 204D Condition D.	No visible damage $\Delta R/R < 10\%$
Bend	Tested as shown in diagram  	No visible damage $\Delta R/R < 10\%$
Load Life F0805B, F1206B	25°C, rated current, 20,000 hrs.	No visible damage $\Delta R/R < 10\%$

### FUSE TIME - CURRENT CHARACTERISTICS FOR TYPE F0402E (TYPICAL)

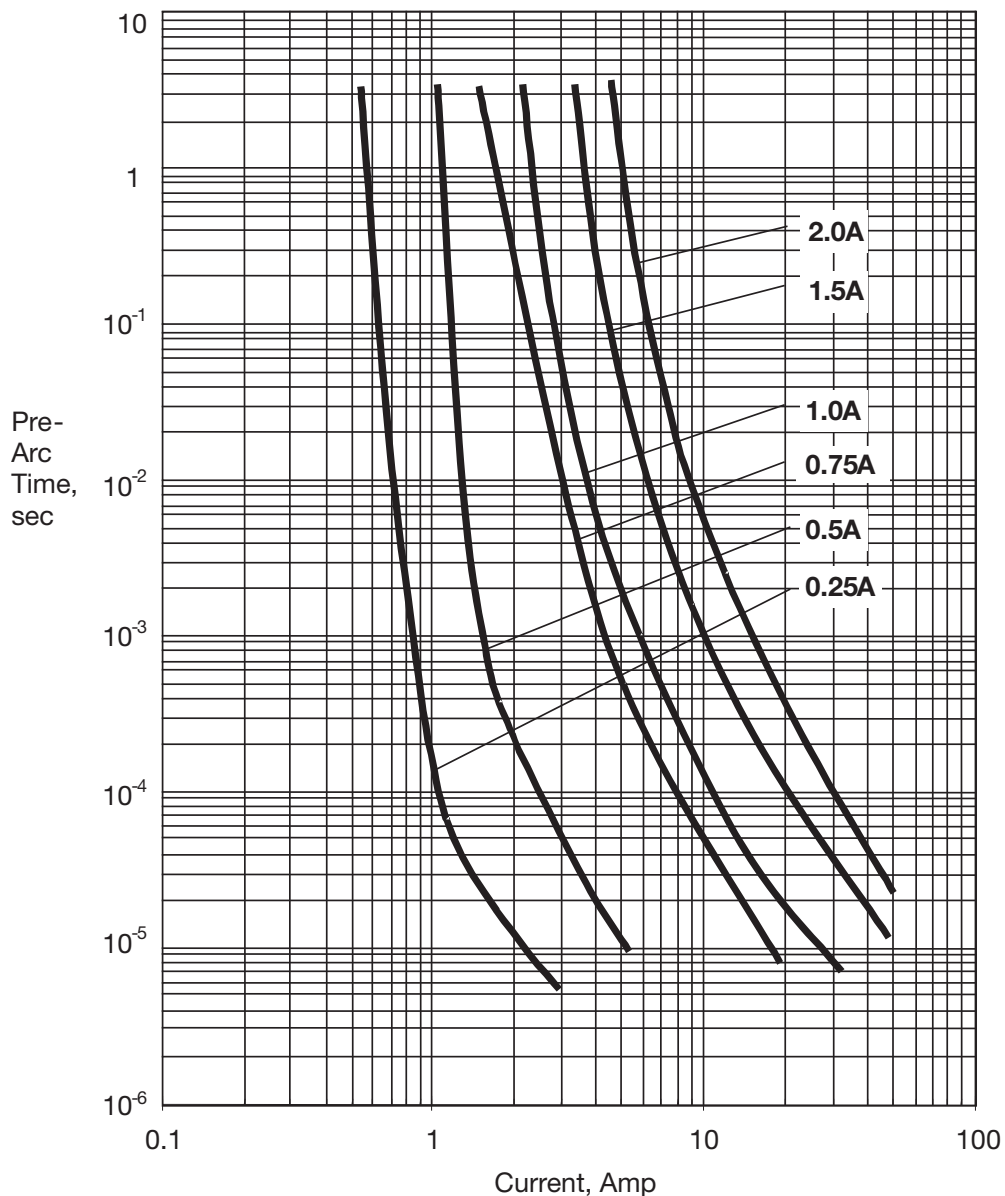

### FUSE PRE-ARC JOULE INTEGRALS VS CURRENT FOR TYPE F0402E (TYPICAL)

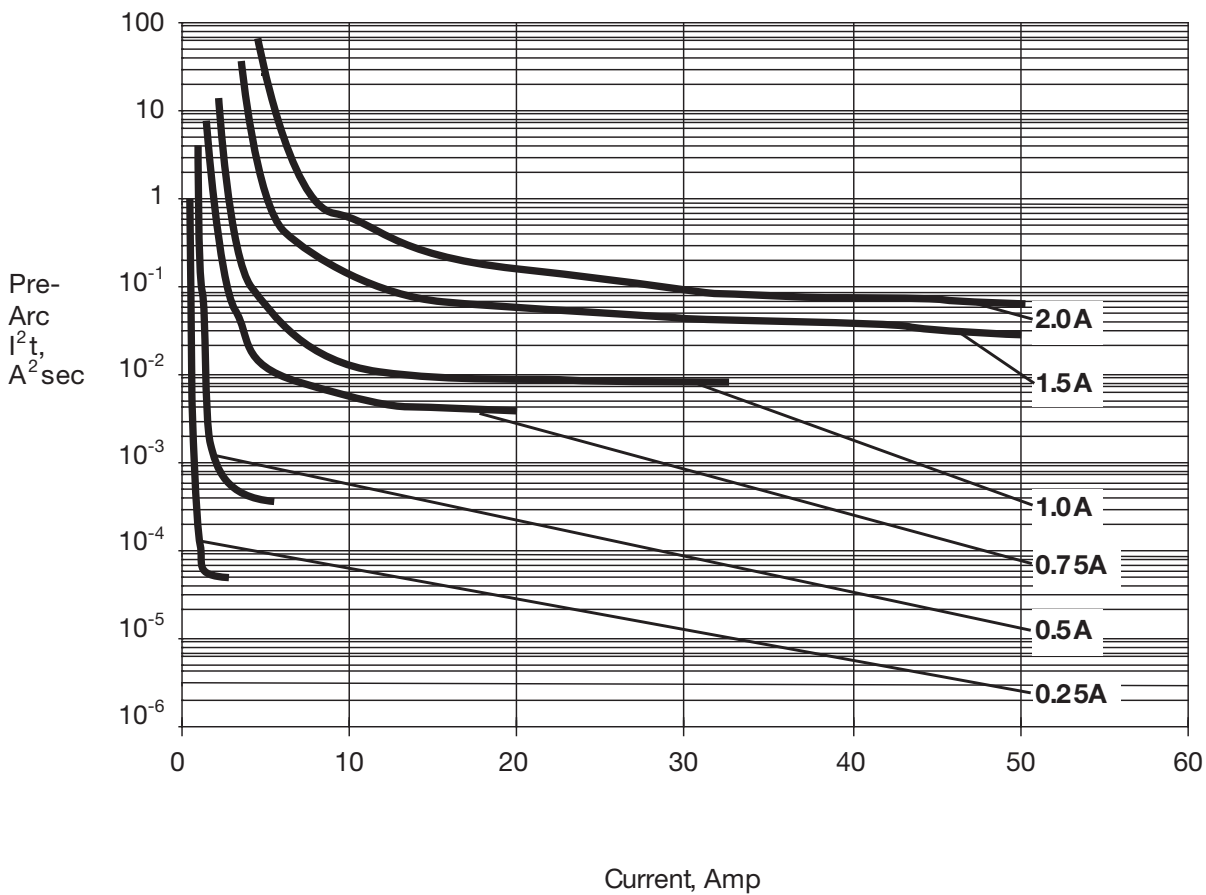

### FUSE PRE-ARC JOULE INTEGRALS VS PRE-ARC TIME FOR TYPE F0402E (TYPICAL)

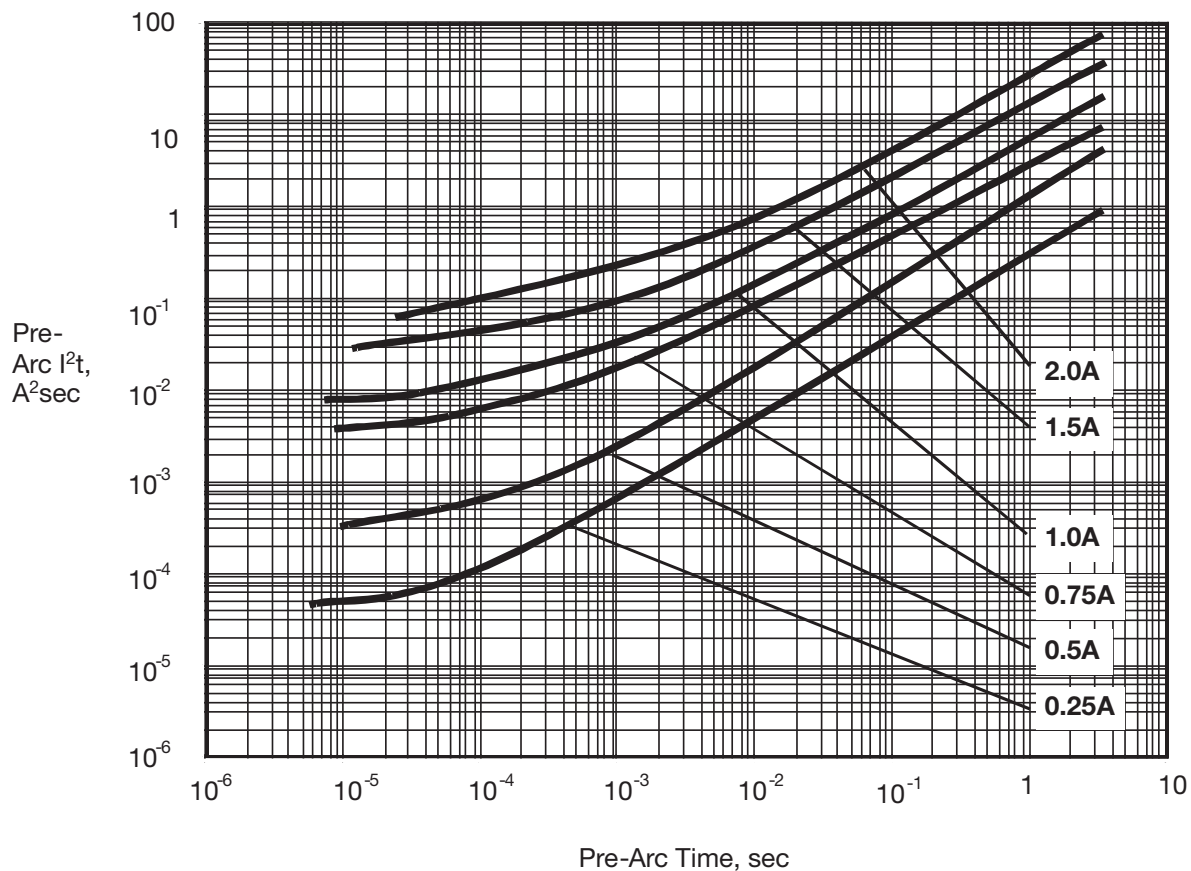

### FUSE TIME - CURRENT CHARACTERISTICS FOR TYPE F0603E (TYPICAL)

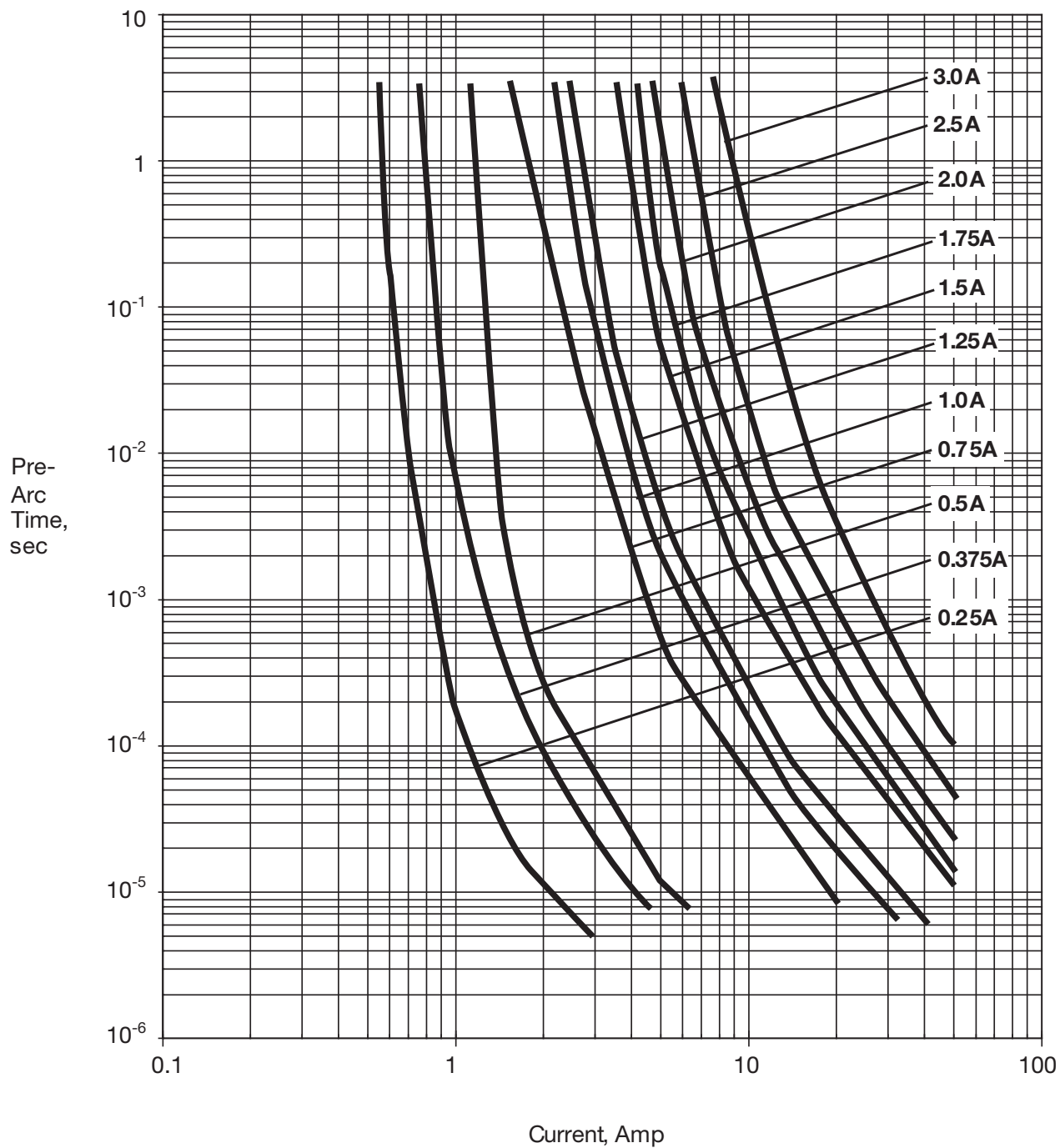

### FUSE PRE-ARC JOULE INTEGRALS VS CURRENT FOR TYPE F0603E (TYPICAL)

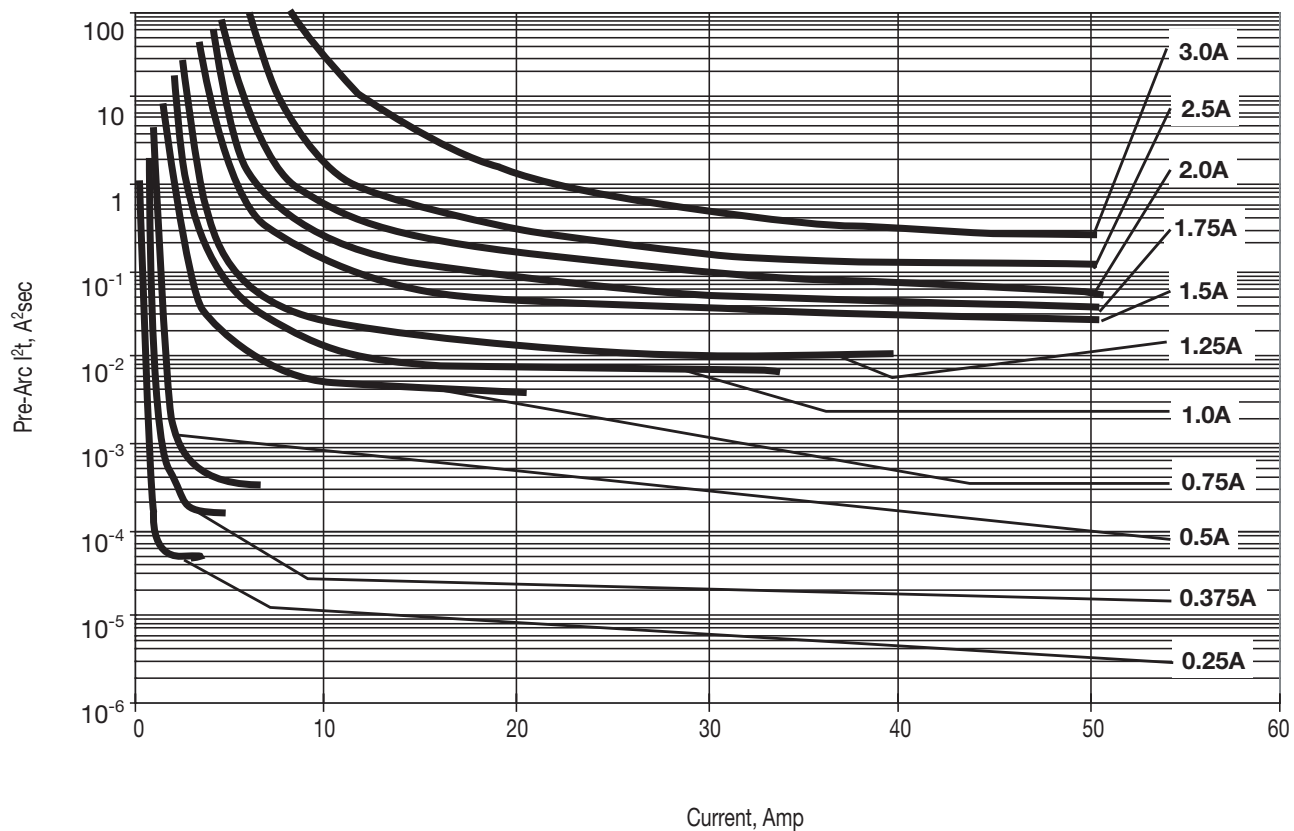

### FUSE PRE-ARC JOULE INTEGRALS VS PRE-ARC TIME FOR TYPE F0603E (TYPICAL)

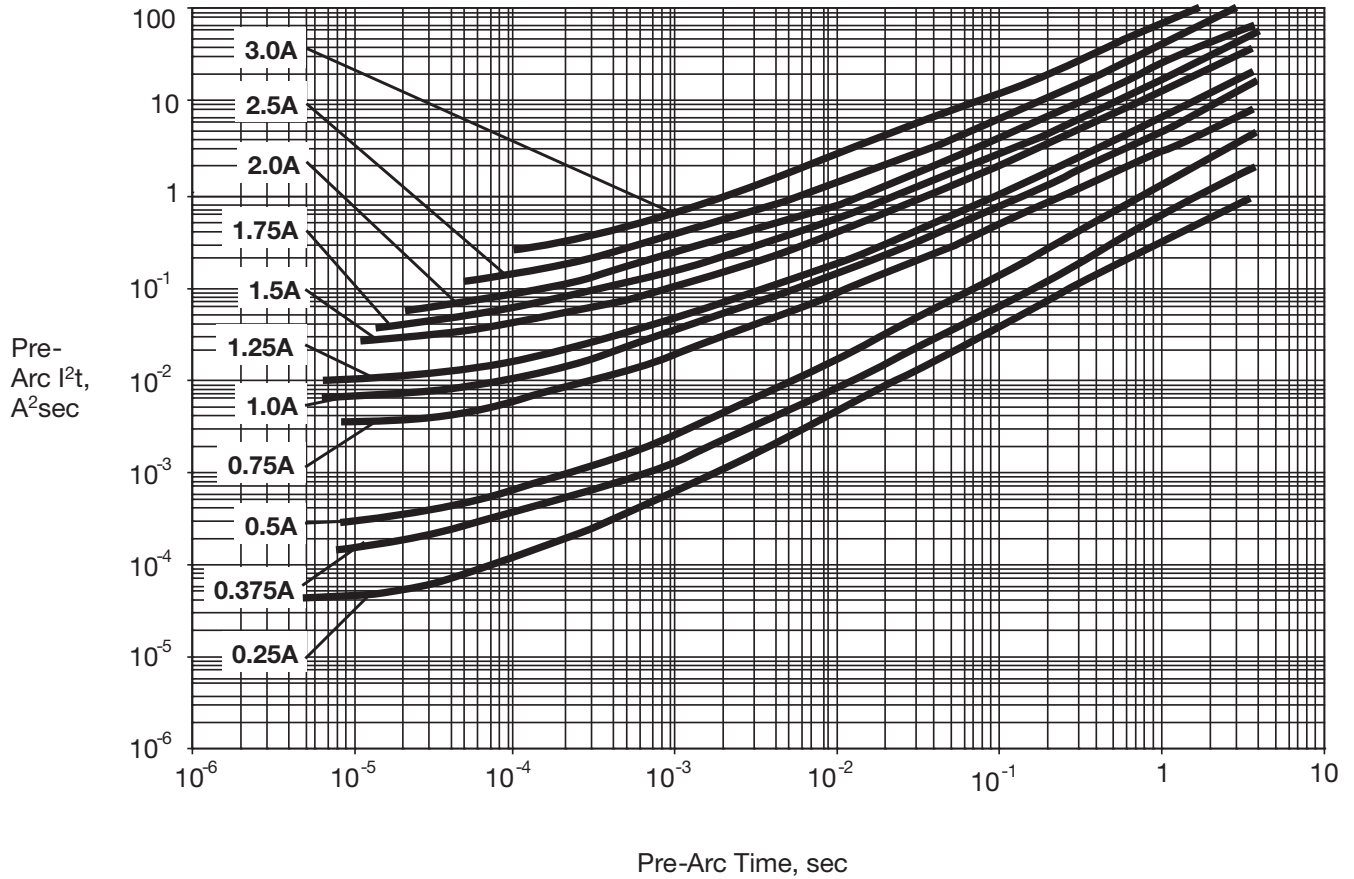

### FUSE TIME - CURRENT CHARACTERISTICS FOR TYPE F0603C (TYPICAL)

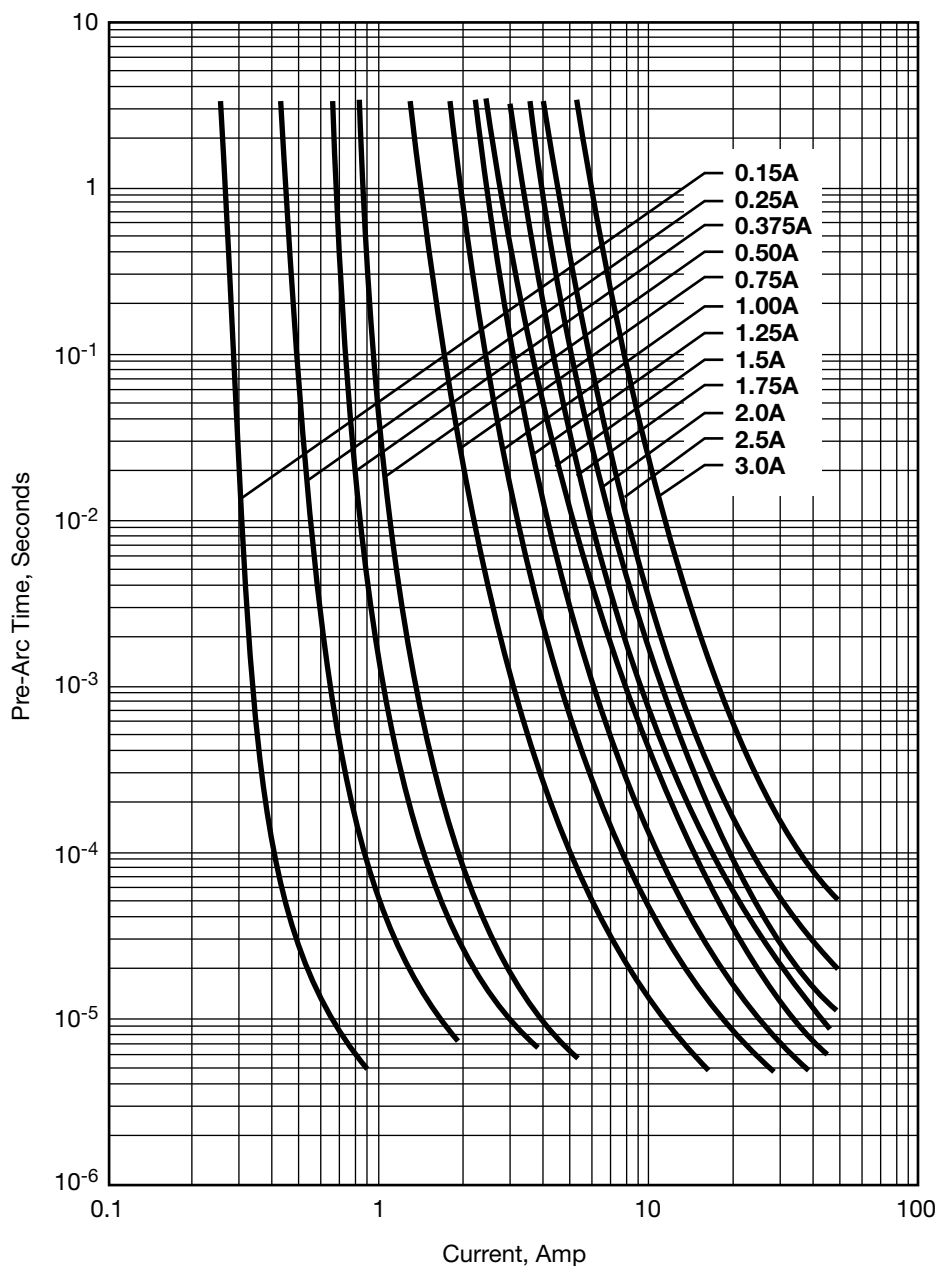

### FUSE PRE-ARC JOULE INTEGRALS VS. CURRENT FOR TYPE F0603C (TYPICAL)

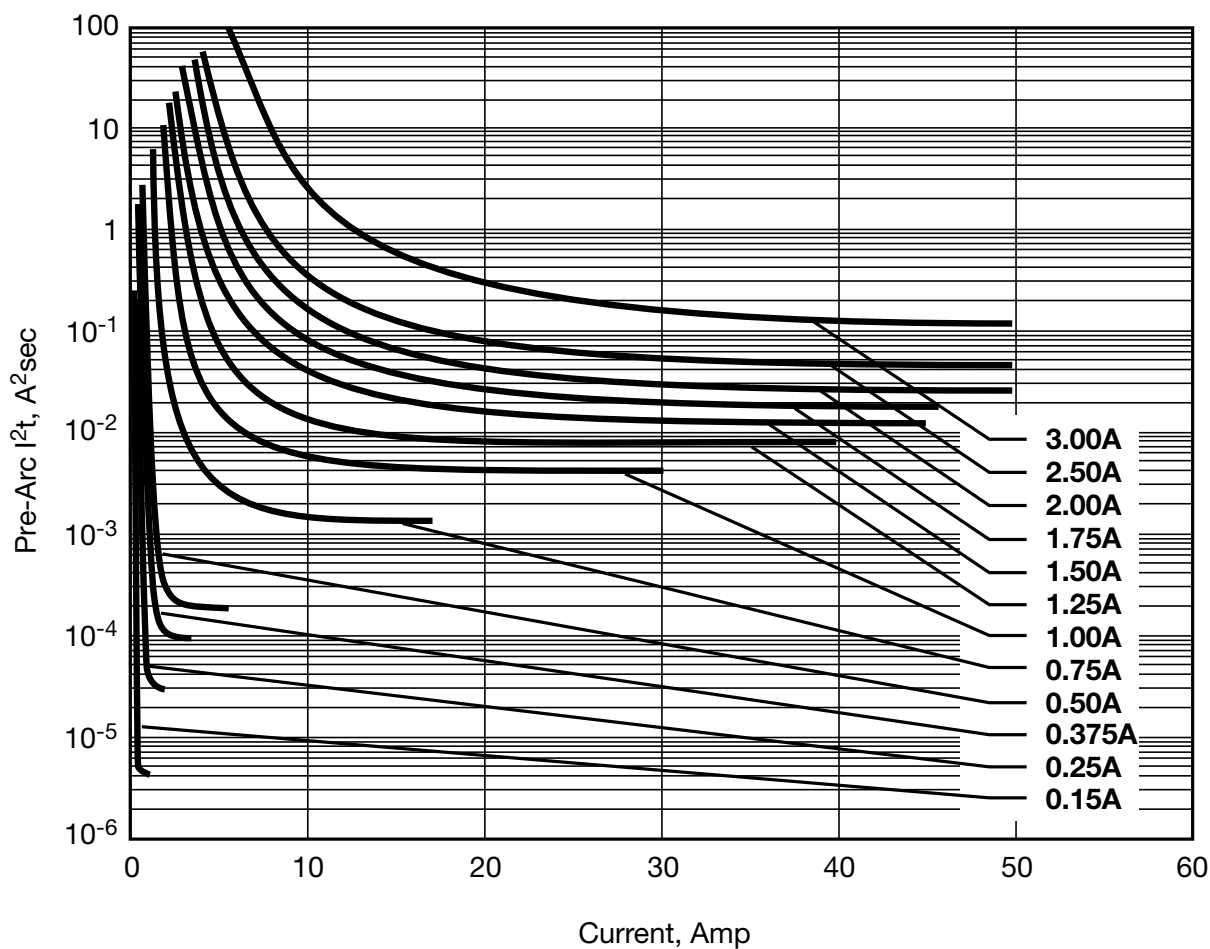

### FUSE PRE-ARC JOULE INTEGRALS VS. PRE-ARC TIME FOR TYPE F0603C (TYPICAL)

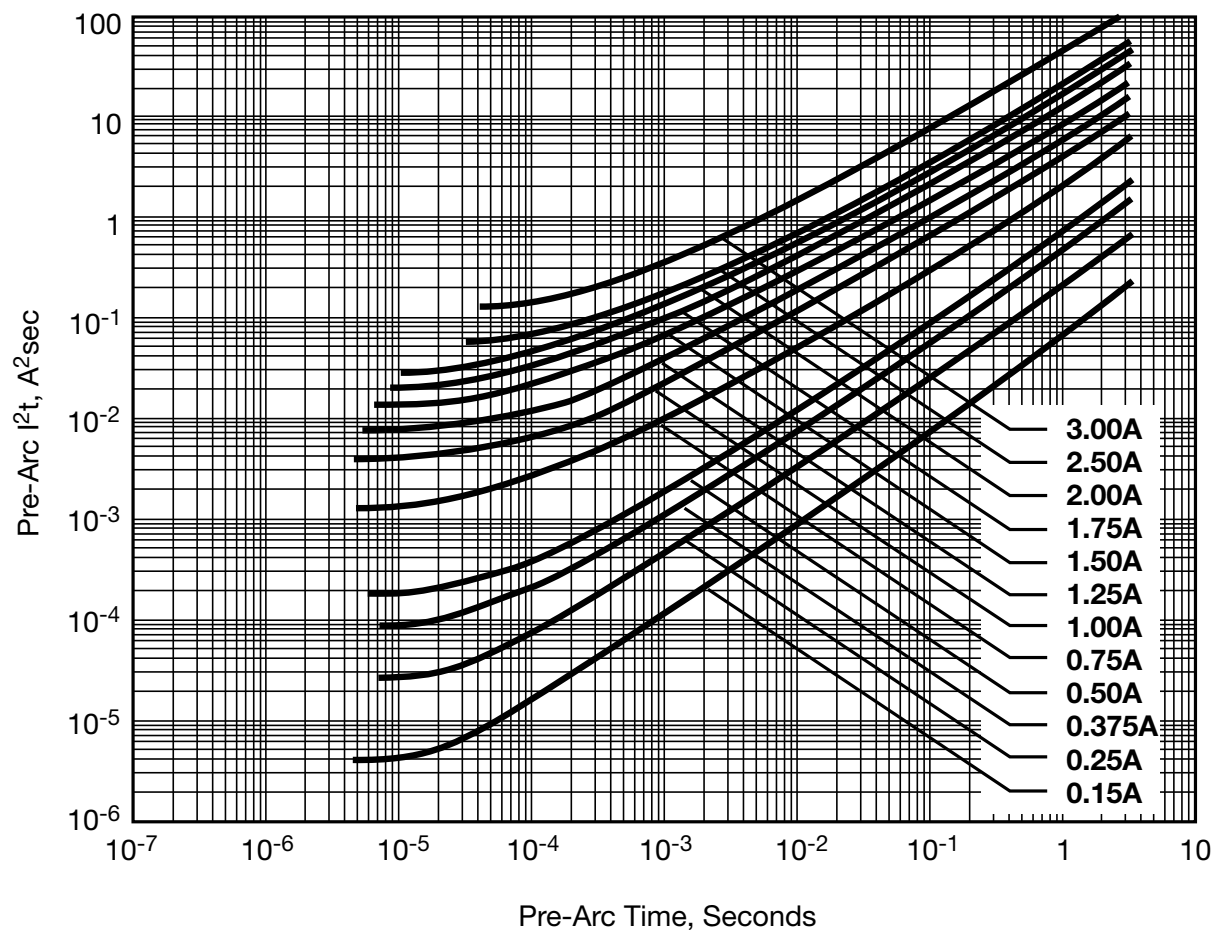

### FUSE TIME - CURRENT CHARACTERISTICS FOR TYPES F0805B AND F1206B (TYPICAL)

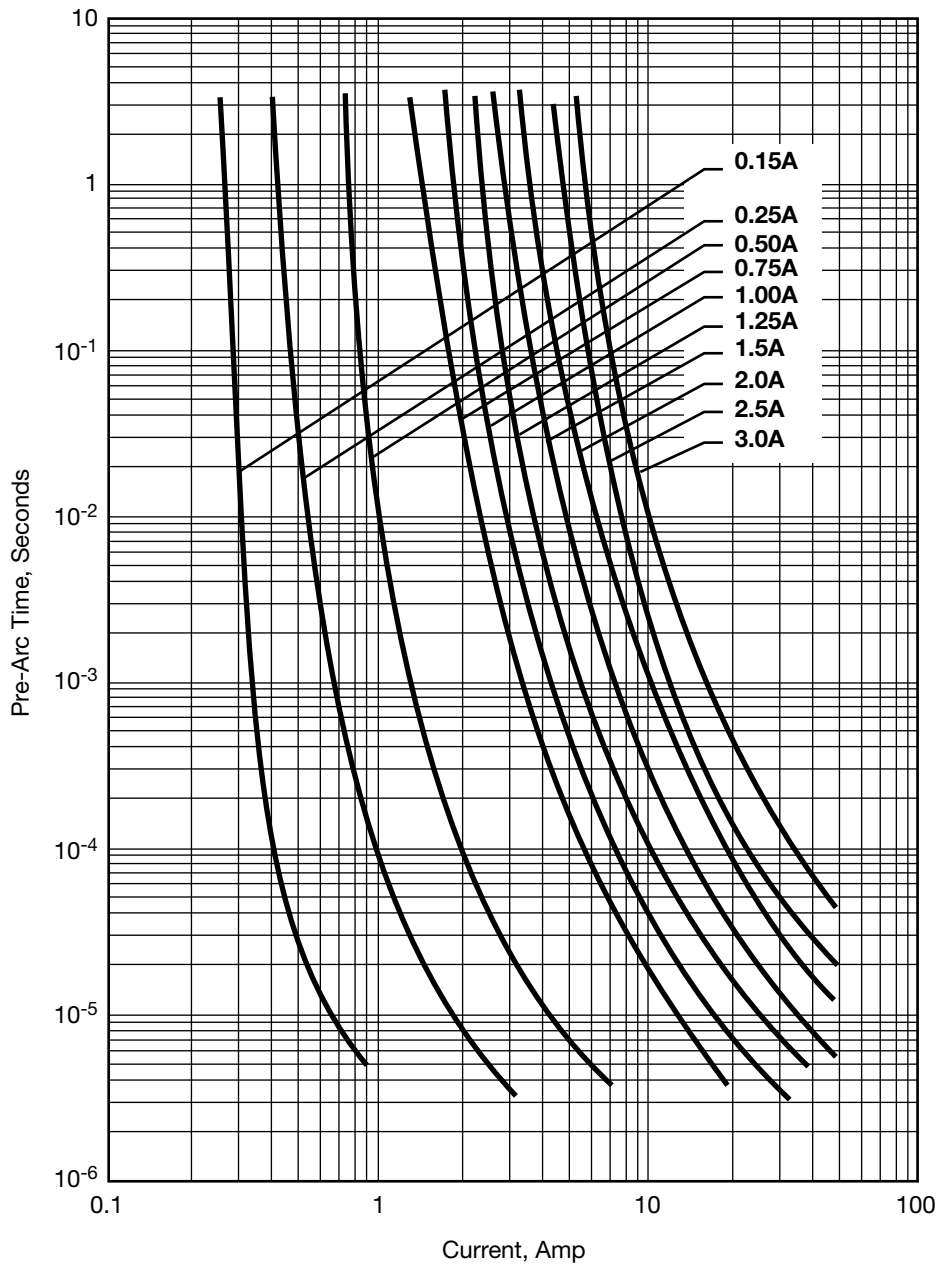

### FUSE PRE-ARC JOULE INTEGRALS VS. CURRENT TIME FOR TYPES F0805B AND F1206B (TYPICAL)

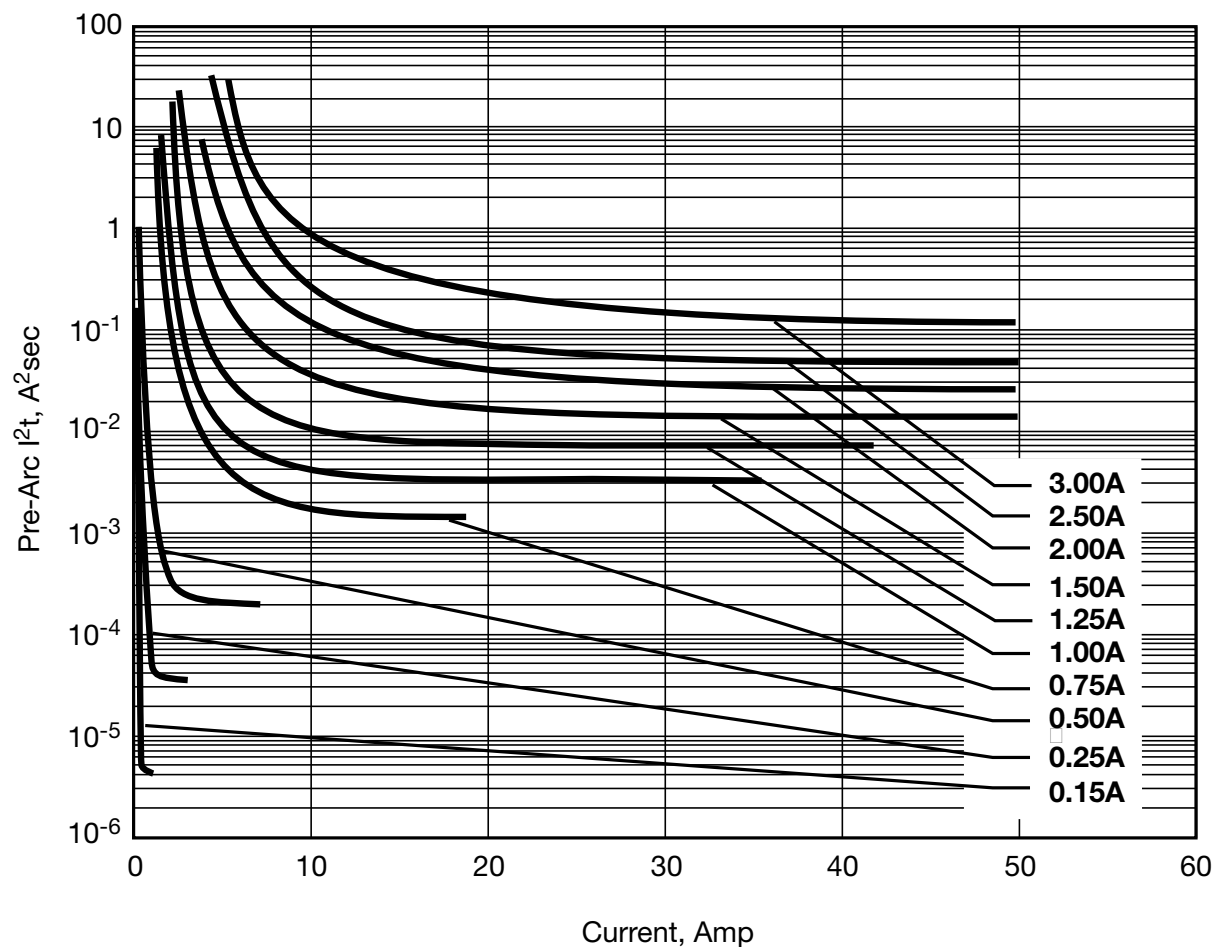

### FUSE PRE-ARC JOULE INTEGRALS VS. PRE-ARC TIME FOR TYPES F0805B AND F1206B (TYPICAL)

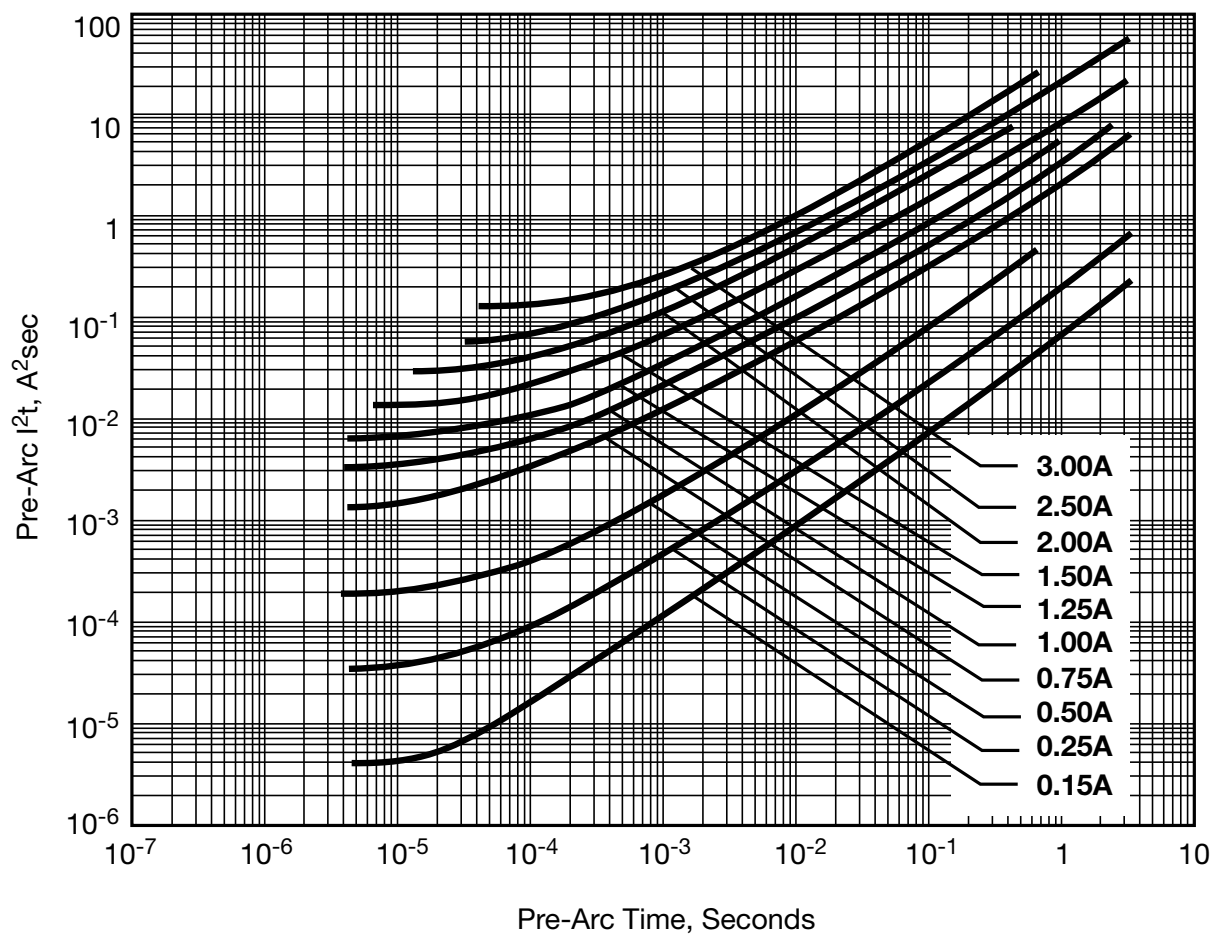

### FUSE TIME - CURRENT CHARACTERISTICS FOR TYPE F0612D (TYPICAL)

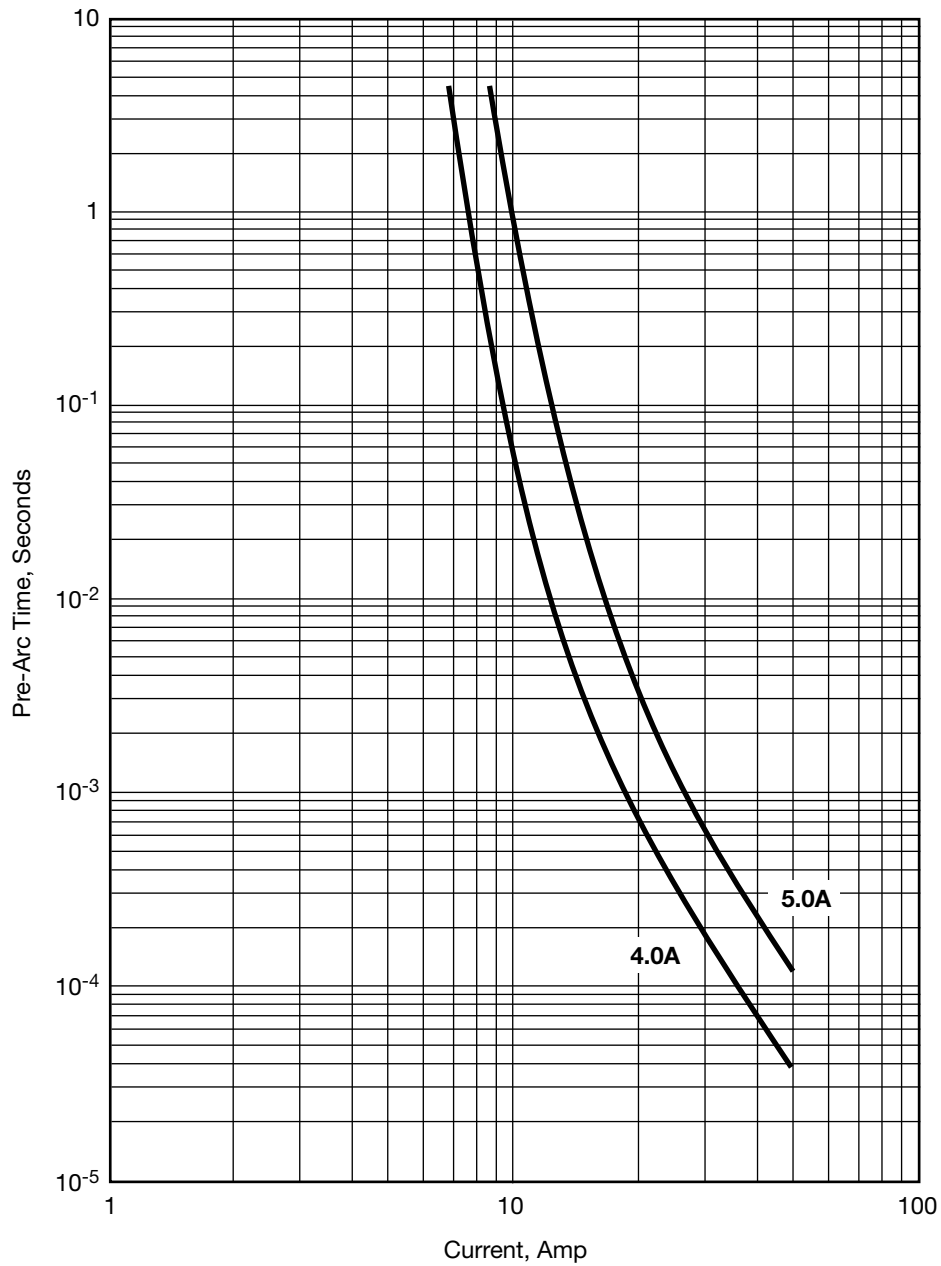

### FUSE PRE-ARC JOULE INTEGRALS VS. PRE-ARC TIME FOR TYPE F0612D (TYPICAL)

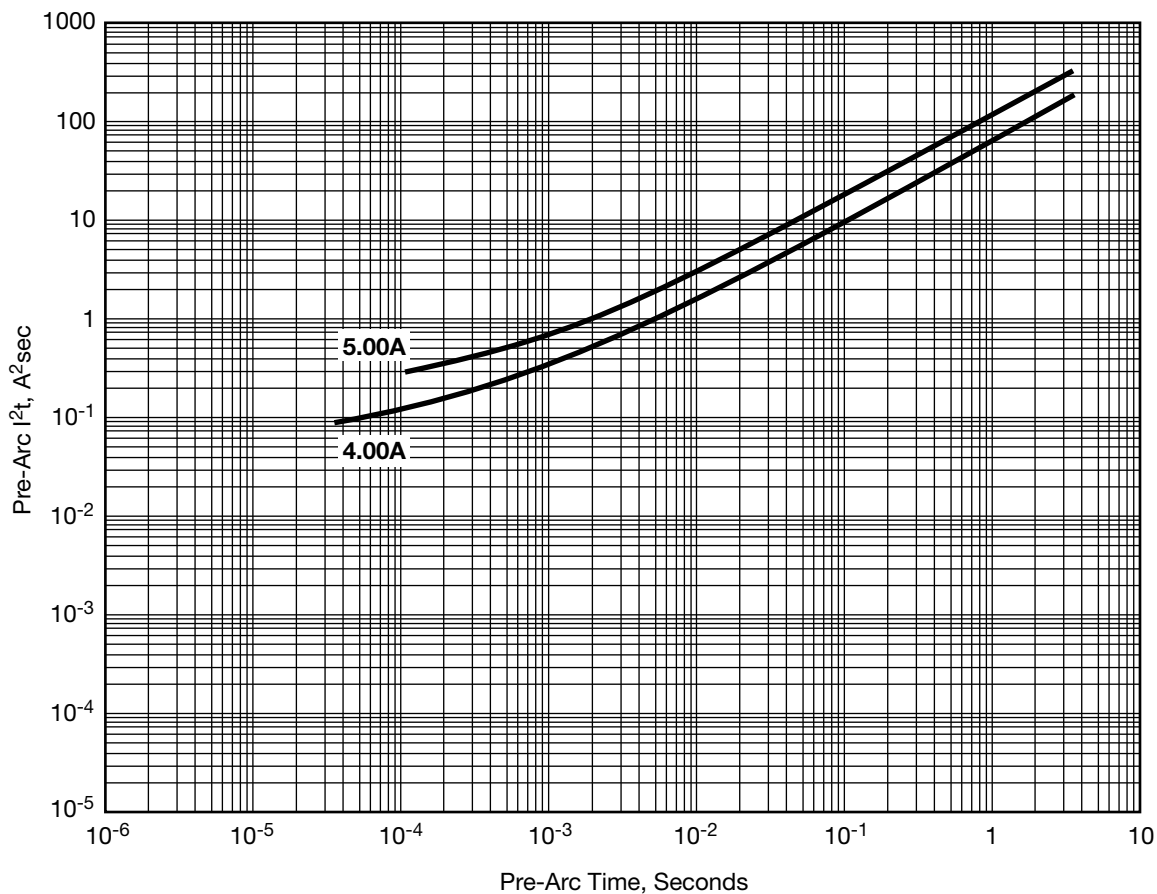

### FUSE PRE-ARC JOULE INTEGRALS VS. CURRENT FOR TYPE F0612D (TYPICAL)

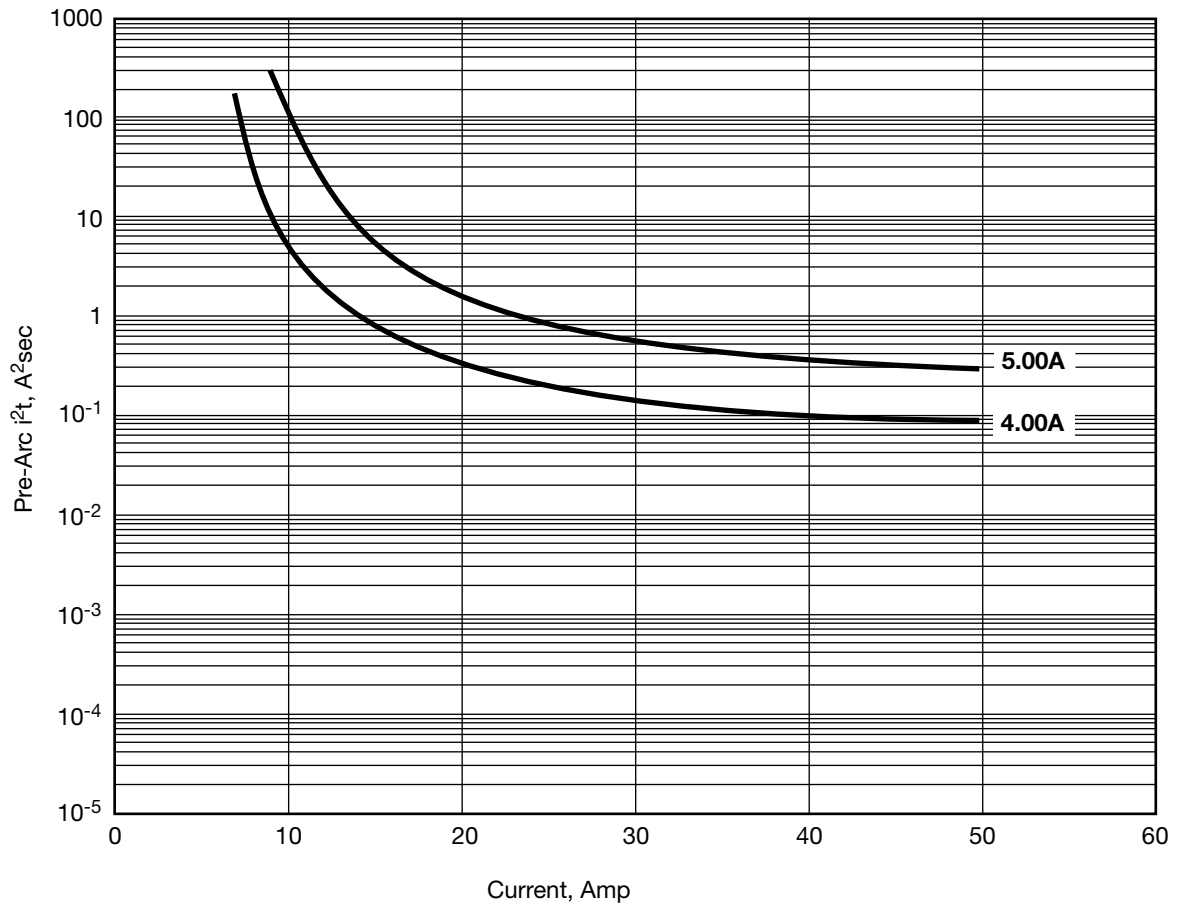

## SMD Thin-Film Fuse

### ELECTRICAL SPECIFICATIONS

Operating Temperature: -55°C to +125°C

Current carrying capacity at -55°C is 107% of rating;  
at +25°C 100% of rating; at +85°C 93% of rating;  
at +125°C 90% of rating.

Rated Voltage: 32V

Interrupting Rating: 50A

Insulation Resistance: >20MΩ guaranteed (after fusing at rated voltage)

### 1206

Part Number	Current Rating A	Resistance @ 10% x I rated, 25°C Ω (Max.)	Voltage Drop @ 1 x I rated, 25°C mV (Max.)	Fusing Current (within 5 sec.) 25°C A	Pre-Arc I <sup>2</sup> t @ 50A A <sup>2</sup> - sec.
F1206A0R20FWTR	0.200	0.95	350	0.40	0.00002*
F1206A0R25FWTR	0.250	0.75	280	0.50	0.00004*
F1206A0R37FWTR	0.375	0.40	220	0.75	0.00006
F1206A0R50FWTR	0.500	0.35	220	1.00	0.0002
F1206A0R75FWTR	0.750	0.25	220	1.50	0.003
F1206A1R00FWTR	1.000	0.18	220	2.00	0.005
F1206A1R25FWTR	1.250	0.15	220	2.50	0.009
F1206A1R50FWTR	1.500	0.11	220	3.00	0.02
F1206A1R75FWTR	1.750	0.10	210	3.50	0.035
F1206A2R00FWTR	2.000	0.065	160	4.00	0.04

\* Current is limited to less than 50A at 32V due to internal fuse resistance.

### ENVIRONMENTAL CHARACTERISTICS

Test	Conditions	Requirement
Solderability	Components completely immersed in a solder bath at 235 ±5°C for 2 secs.	Terminations to be well tinned No visible damage
Leach Resistance	Completely immersed in a solder bath at 260 ±5°C for 60 secs.	Dissolution of termination ≤ 25% of area ΔR/R<10%
Storage	12 months minimum with components stored in "as received" packaging.	Good solderability
Shear	Components mounted to a substrate. A force of 5N applied normal to the line joining the terminations and in a line parallel to the substrate.	No visible damage
Rapid Change of Temperature	Components mounted to a substrate. 5 cycles -55°C to +125°C.	No visible damage Δ R/R<10%
Vibration	Per Mil-Std-202F Method 201A and Method 204D Condition D.	No visible damage ΔR/R<10%
Load Life	25°C, I rated, 20,000 hrs.	No visible damage ΔR/R<10%

\*Not recommended for new designs, please consult factory.

### FUSE TIME - CURRENT CHARACTERISTICS FOR SIZE 1206 (TYPICAL)

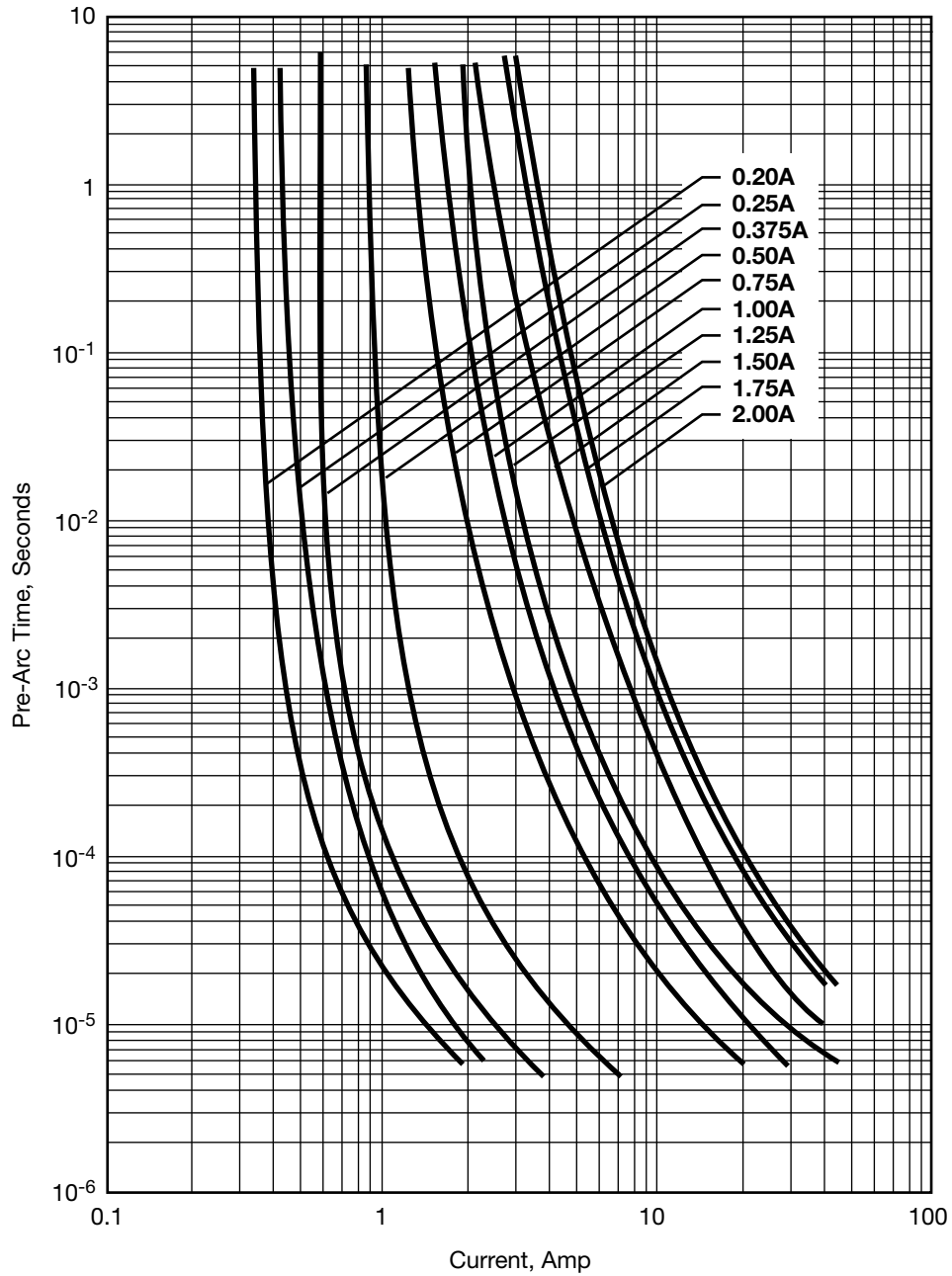

### FUSE PRE-ARC JOULE INTEGRALS VS. CURRENT FOR SIZE 1206 (TYPICAL)

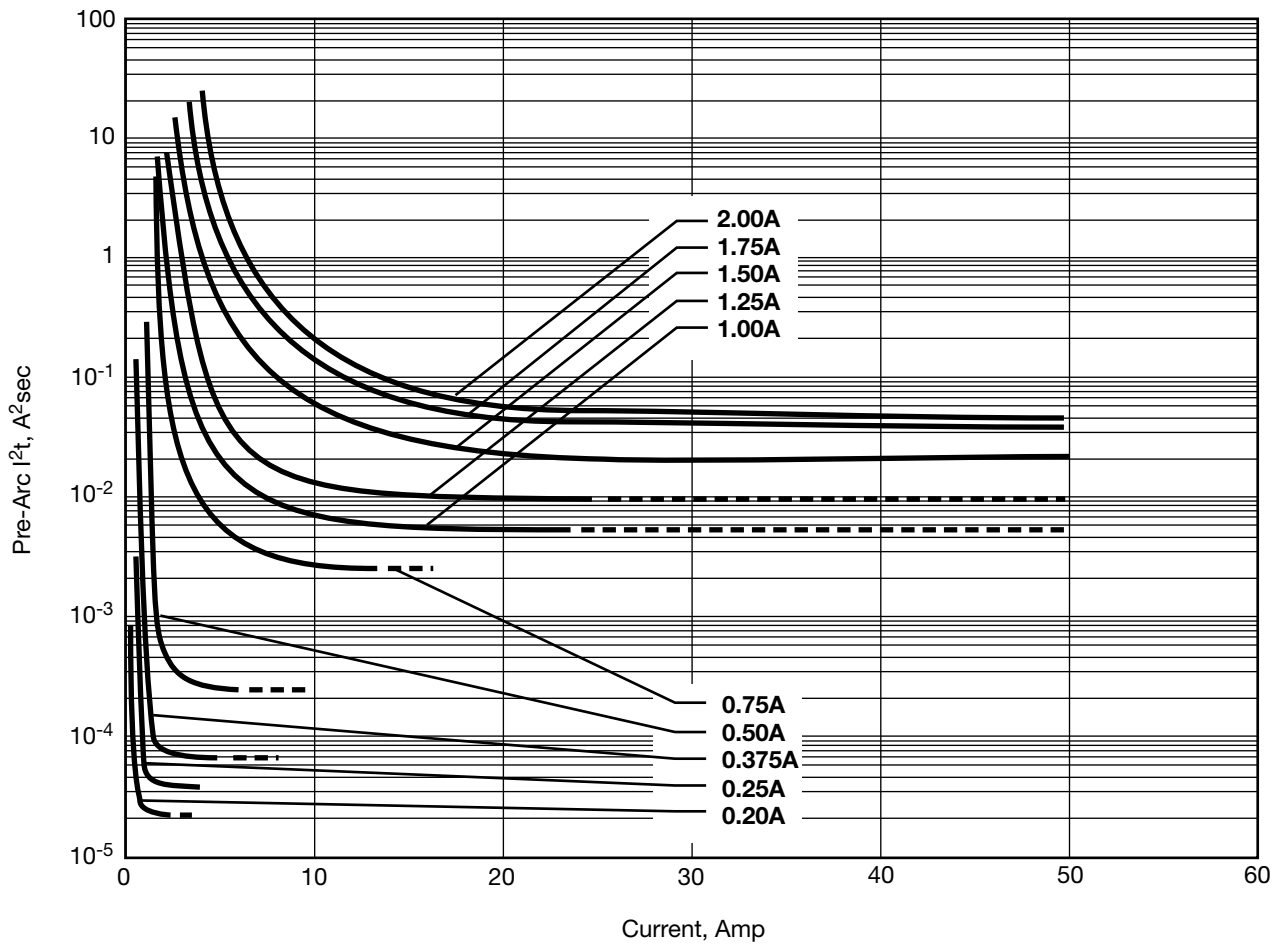

### FUSE PRE-ARC JOULE INTEGRALS VS. PRE-ARC TIME FOR SIZE 1206 (TYPICAL)

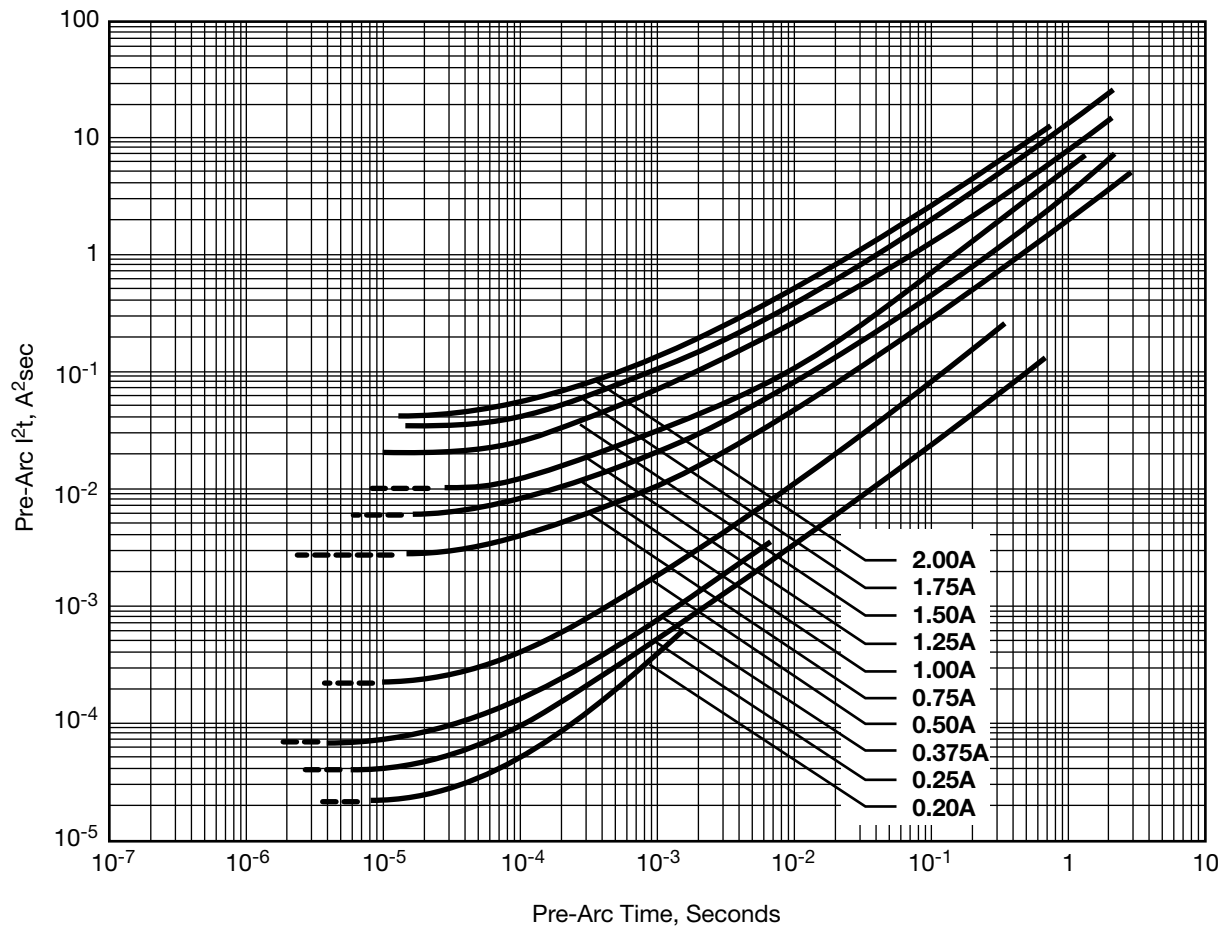

### QUALITY & RELIABILITY

Accu-Guard® series of fuses is based on established thin-film technology and materials used in the semiconductor industry.

- In-line Process Control:** This program forms an integral part of the production cycle and acts as a feedback system to regulate and control production processes. The test procedures, which are integrated into the production process, were developed after long research and are based on the highly developed semiconductor industry test procedures and equipment. These measures help AVX/Kyocera to produce a consistent and high yield line of products.
- Final Quality Inspection:** Finished parts are tested for standard electrical parameters and visual/mechanical characteristics. Each production lot is 100% evaluated for electrical resistance. In addition, each production lot is evaluated on a sample basis for:
  - Insulation resistance (post fusing)
  - Blow time for 2 x rated current
  - Endurance test: 125°C, rated current, 4 hours

### HANDLING AND SOLDERING

SMD chips should be handled with care to avoid damage or contamination from perspiration and skin oils. The use of plastic tipped tweezers or vacuum pick-ups is strongly recommended for individual components. Bulk handling should ensure that abrasion and mechanical shock are minimized. For automatic equipment, taped and reeled product is the ideal medium for direct presentation to the placement machine.

### CIRCUIT BOARD TYPE

All flexible types of circuit boards may be used (e.g. FR-4, G-10).

For other circuit board materials, please consult factory.

### WAVE SOLDERING

**Dimensions: millimeters (inches)**

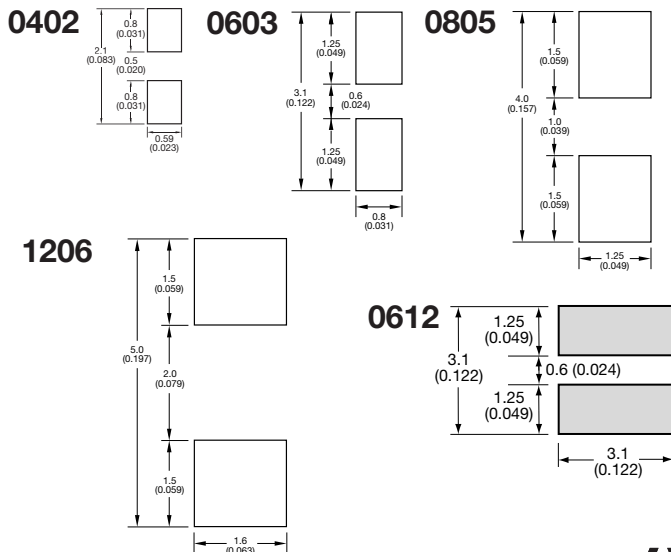

### COMPONENT PAD DESIGN

Component pads must be designed to achieve good joints and minimize component movement during soldering.

Pad designs are given below for both wave and reflow soldering.

The basis of these designs are:

- Pad width equal to component width. It is permissible to decrease this to as low as 85% of component width but it is not advisable to go below this.
- Pad overlap 0.5mm.
- Pad extension 0.5mm for reflow. Pad extension about 1.0mm for wave soldering.

### PREHEAT & SOLDERING

The rate of preheat in production should not exceed 4°C/second. It is recommended not to exceed 2°C/second.

Temperature differential from preheat to soldering should not exceed 150°C.

For further specific application or process advice, please consult AVX.

### HAND SOLDERING & REWORK

Hand soldering is permissible. Preheat of the PCB to 100°C is required. The most preferable technique is to use hot air soldering tools. Where a soldering iron is used, a temperature controlled model not exceeding 30 watts should be used and set to not more than 260°C. Maximum allowed time at temperature is 1 minute.

### COOLING

After soldering, the assembly should preferably be allowed to cool naturally. In the event of assisted cooling, similar conditions to those recommended for preheating should be used.

### REFLOW SOLDERING

**Dimensions: millimeters (inches)**

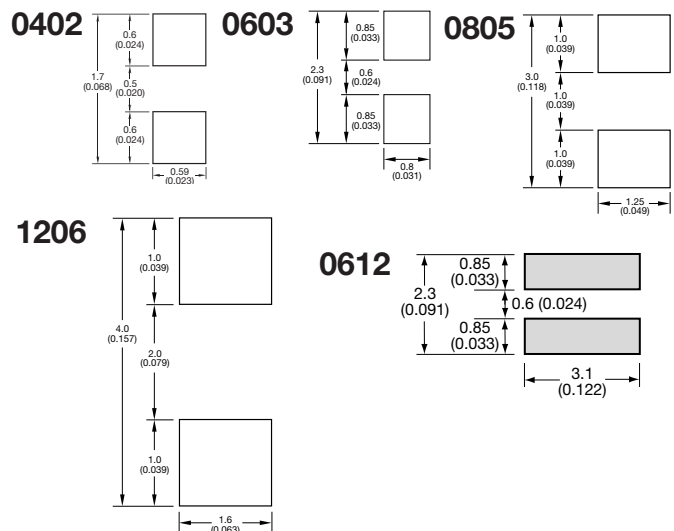

### RECOMMENDED SOLDERING PROFILES

#### IR REFLOW

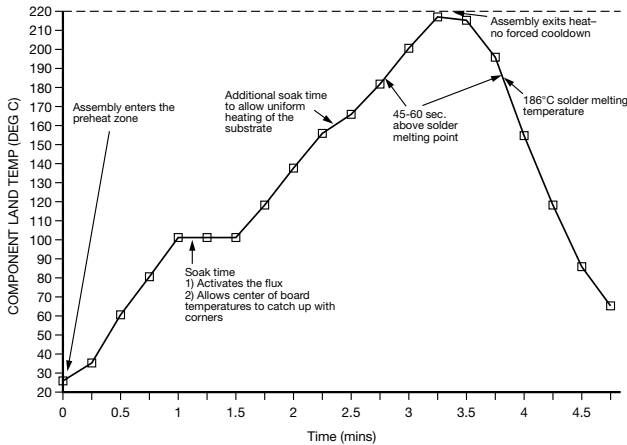

### CLEANING RECOMMENDATIONS

Care should be taken to ensure that the devices are thoroughly cleaned of flux residues, especially the space beneath the device. Such residues may otherwise become conductive and effectively offer a lousy bypass to the device. Various recommended cleaning conditions (which must be optimized for the flux system being used) are as follows:

- Cleaning liquids . . . . . i-propanol, ethanol, acetylacetone, water, and other standard PCB cleaning liquids.
- Ultrasonic conditions . . . power – 20w/liter max. frequency – 20kHz to 45kHz.
- Temperature . . . . . 80°C maximum (if not otherwise limited by chosen solvent system).
- Time . . . . . .5 minutes max.

#### WAVE SOLDERING

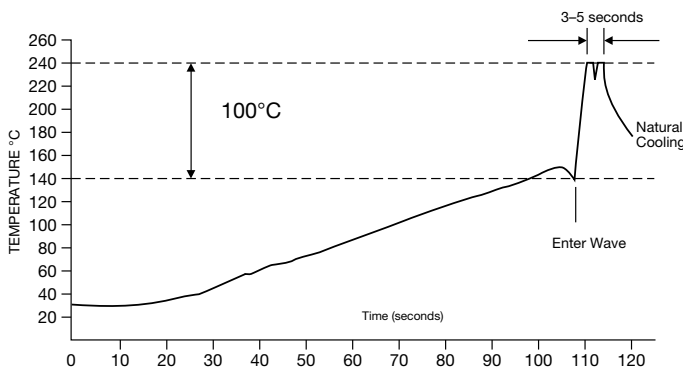

### STORAGE CONDITIONS

Recommended storage conditions for Accu-Guard® prior to use are as follows:

- Temperature . . . . . 15°C to 35°C
- Humidity . . . . . ≤65%
- Air Pressure . . . . . 860mbar to 1060mbar

#### VAPOR PHASE

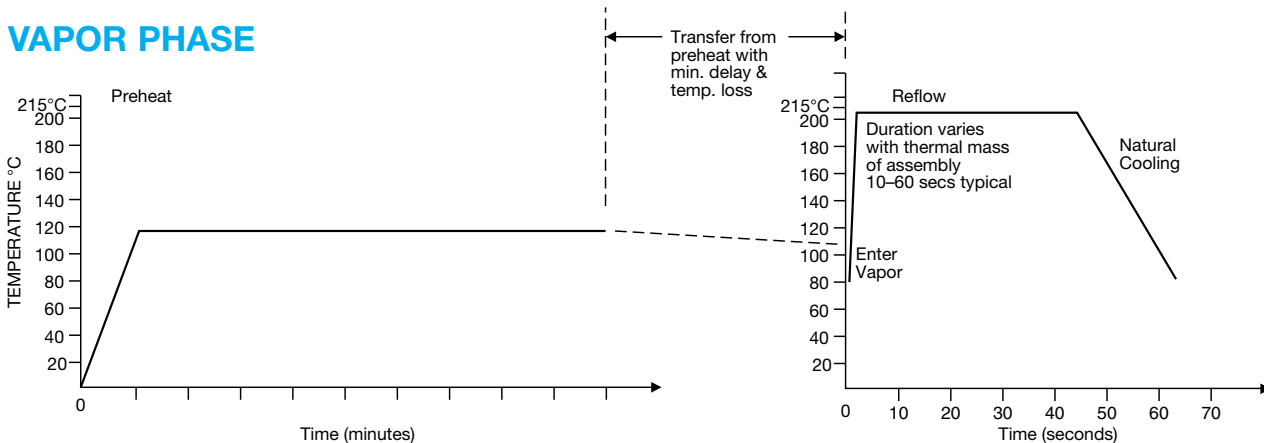

## SMD Thin-Film Fuse

### PACKAGING

Automatic Insertion Packaging

Tape & Reel: All tape and reel specifications are in compliance with EIA 481-1

- 8mm carrier
- Reeled quantities: Reels of 3,000 or 10,000 pieces  
(for F0402: 5,000 or 20,000 pieces)

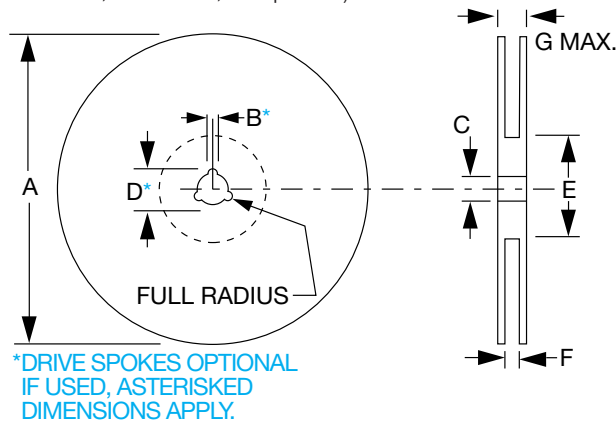

### REEL DIMENSIONS: millimeters (inches)

A(1)	B*	C	D*	E	F	G
180 ± 1.0 (7.087 ± 0.039)	1.5 min. (0.059 min.)	13 ± 0.2 (0.512 ± 0.008)	20.2 min. (0.795 min.)	50 min. (1.969 min.)	9.4 ± 1.5 (0.370 ± 0.050)	14.4 max. (0.567 max.)

Metric dimensions will govern.  
Inch measurements rounded for reference only.  
(1) 330mm (13 inch) reels are available.

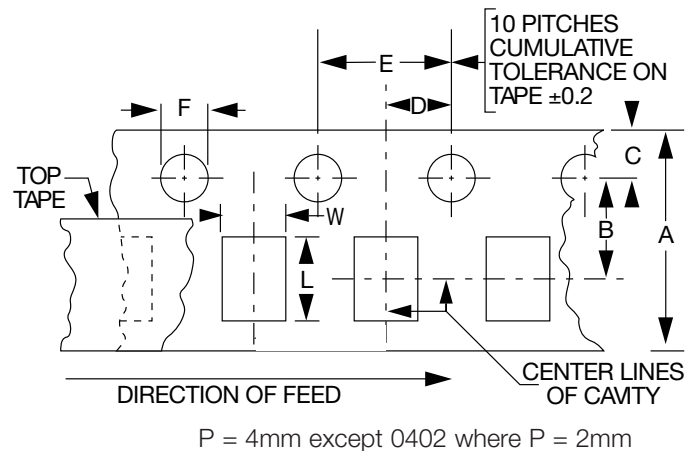

### CARRIER DIMENSIONS: millimeters (inches)

A	B	C	D	E	F
8.0 ± 0.3 (0.315 ± 0.012)	3.5 ± 0.05 (0.138 ± 0.002)	1.75 ± 0.1 (0.069 ± 0.004)	2.0 ± 0.05 (0.079 ± 0.002)	4.0 ± 0.1 (0.157 ± 0.004)	1.5 <sup>+0.1</sup> <sub>-0.0</sub> (0.059 <sup>+0.004</sup> <sub>-0.000</sub> )

Note: The nominal dimensions of the component compartment (W,L) are derived from the component size.

**Note:** AVX reserves the right to change the information published herein without notice.

### HOW TO CHOOSE THE CORRECT ACCU-GUARD® FUSE FOR CIRCUIT PROTECTION

Correct choice of an Accu-Guard® fuse for a given application is fairly straightforward. The factor of pre-arc  $I^2t$ , however, requires clarification. The proper design for pre-arc  $I^2t$  is presented by way of example.

#### DESIGN PARAMETERS

##### 1. Operating Temperature

The Accu-Guard® is specified for operation in the temperature range of  $-55^{\circ}\text{C}$  to  $+125^{\circ}\text{C}$ . Note, however, that fusing current is sensitive to temperature. This means that the fuse must be derated or uprated at circuit temperatures other than  $25^{\circ}\text{C}$ :

Environmental Temperature	Accu-Guard® Current Carrying Capacity*				
	F0402E, F0603E	F0805B, F1206A, F1206B	F0805B 2.50A & 3.00A	F0603C	F0612D
$-55^{\circ}\text{C}$ to $-11^{\circ}\text{C}$	$1.07 \times I_R$	$1.07 \times I_R$	$1.07 \times I_R$	$1.07 \times I_R$	$1.07 \times I_R$
$-10^{\circ}\text{C}$ to $60^{\circ}\text{C}$	$I_R$	$I_R$	$I_R$	$I_R$	$I_R$
$61^{\circ}\text{C}$ to $100^{\circ}\text{C}$	$0.85 \times I_R$	$0.93 \times I_R$	$0.90 \times I_R$	$0.90 \times I_R$	$0.80 \times I_R$
$101^{\circ}\text{C}$ to $125^{\circ}\text{C}$	$0.80 \times I_R$	$0.90 \times I_R$	$0.90 \times I_R$	$0.75 \times I_R$	$0.75 \times I_R$

\*As a function of nominal rated current,  $I_R$ .

##### 2. Circuit Voltage

**Maximum Voltage:** Accu-Guard® is specified for circuits of up to rated voltage. Accu-Guard® will successfully break currents at higher voltages as well, but over voltage may crack the fuse body.

**Minimum Voltage:** Accu-Guard® cannot be used in circuits with voltage of about 0.5V and less. The internal resistance of the fuse will limit the fault current to a value which will prevent reliable actuation of the fuse ( $<2 \times$  rated current).

##### 3. Maximum Fault Current

Accu-Guard® is fully tested and specified for fault currents up to 50A. Accu-Guard® will successfully break currents above 50A, but such over current may crack the fuse body or damage the fuse terminations.

##### 4. Steady-State Current

The Accu-Guard® current rating is based on IEC Specification 127-3. In accordance with this international standard, Accu-Guard® is specified to operate at least 4 hours at rated current without fusing ( $25^{\circ}\text{C}$ ). Engineering tests have shown that F0805B and F1206A/B Accu-Guard® will in fact operate at least 20,000 hours at rated current without fusing ( $25^{\circ}\text{C}$ ).

##### 5. Switch-on and Other Pulse Current

Many circuits generate a large current pulse when initially connected to power. There are also circuits which are subject to momentary current pulses due to external sources; telephone line cards which are subject to lightning-induced pulses are one example. These current pulses must be passed by the fuse **without** causing actuation. These pulses may be so large that they are the determining factor for choosing the Accu-Guard® current rating; not necessarily steady state current.

In order to design for current pulses, the concept of fuse pre-arc Joule integral,  $I^2t$ , must be understood. Fuse current rating is defined by the requirement that  $2 \times I_R$  will cause actuation in  $<5$  seconds. This rating does not indicate how the fuse will react to very high currents of very short duration. Rather, the fusing characteristic at very high currents is specified by  $I^2t$ -t curves (or  $I^2t$ -I).

$I^2t$  expresses the amount of energy required to actuate the fuse. Total  $I^2t$  expresses the total energy which will be passed by the fuse until total cessation of current flow. Pre-arc  $I^2t$  expresses that energy required to cause large irreversible damage to the fuse element (Total  $I^2t =$  pre-arc  $I^2t +$  arc  $I^2t$ ). If the Joule integral of the switch-on pulse is larger than the fuse pre-arc  $I^2t$ , nuisance actuation will occur.

In order to choose the proper Accu-Guard® current rating for a given application, it is necessary to calculate the  $I^2t$  Joule integral of the circuit switch-on and other current pulses and compare them to the Accu-Guard®  $I^2t$ -t curves. An Accu-Guard® fuse must be chosen such that the pulse  $I^2t$  is no more than 50% of the pre-arc  $I^2t$  of the prospective fuse.

Pre-arc  $I^2t$  of the Accu-Guard® fuses is well characterized;  $I^2t$ -t and  $I^2t$ -I graphs are in this catalog. The problem is calculating the  $I^2t$  of the circuit current pulses. This concept is not familiar to most engineers. Correct calculation of pulse Joule integral and subsequent choice of Accu-Guard® current rating is illustrated by way of the attached examples.

### DESIGNING FOR CURRENT PULSE SITUATIONS

#### 1. Sine wave current pulse

The Joule integral for sine wave pulse is

$$[(I_{max.})^2 \times t]/2,$$

see Fig. 1a.

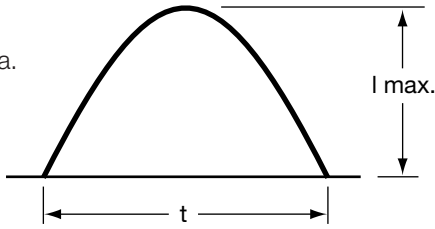

**Fig. 1a.** Sine wave pulse parameters for Joule integral calculation, example #1.

Thus, for the current pulse in Figure 1b, the Joule integral is  $[(4.8A)^2 \times 7.7 \times 10^{-6} \text{ sec}]/2 = 8.9 \times 10^{-5} \text{ A}^2 \text{ sec}$ .

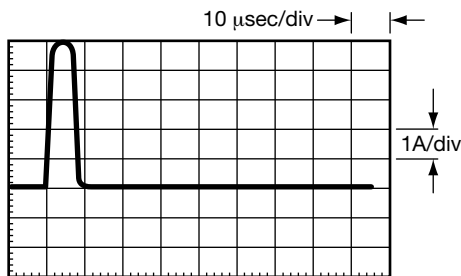

**Fig. 1b.** Sine wave pulse, example #1.

The pulse duration is 7.7μsec. We must find a fuse that can absorb at least  $8.9 \times 10^{-5} \times 2 = 1.8 \times 10^{-4} \text{ A}^2 \text{ sec}$  Joule integral within 7.7 μsec without actuation. According to the  $I^2t$  graph on page 6, pre-arcing Joule integral is  $2.3 \times 10^{-4} \text{ A}^2 \text{ sec}$  for the 0.5A fuse, which is slightly more than needed. The next lower rating (0.375A), has only  $6 \times 10^{-5} \text{ A}^2 \text{ sec}$ , which is not enough. Therefore, 0.5A fuse should be chosen for this application, see Figure 1c.

#### FUSE PRE-ARCING JOULE INTEGRALS vs. PRE-ARCING TIME

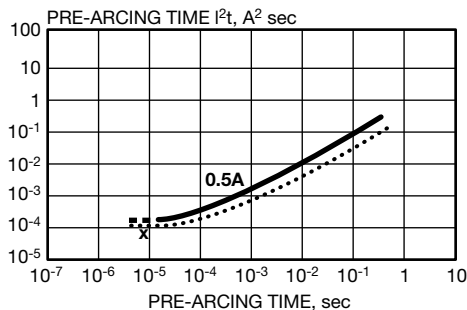

**Fig. 1c.** Choice of 0.5A fuse, example #1.

- Pre-arcing  $I^2t$
- ..... Maximum  $I^2t$  design rule
- x  $I^2t$  for sample current pulse

#### 2. Triangular current pulse

The Joule integral for triangular pulse is

$$[(I_{max.})^2 \times t]/3,$$

see Fig. 2a.

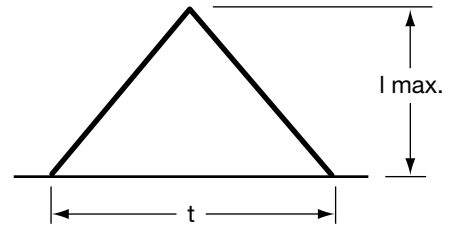

**Fig. 2a.** Triangular pulse parameters for Joule integral calculation, example #2.

Thus, for the current pulse in Figure 2b, the Joule integral is  $[(1.5A)^2 \times 3 \times 10^{-3} \text{ sec}]/3 = 2.25 \times 10^{-3} \text{ A}^2 \text{ sec}$ .

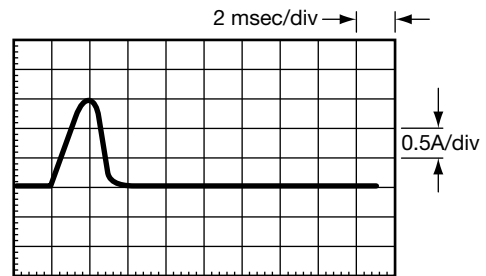

**Fig. 2b.** Triangular pulse, example #2.

The pulse duration is 3 msec. In the  $I^2t$  graph on page 6, pre-arcing Joule integral for 3 msec pulse is  $4 \times 10^{-3} \text{ A}^2 \text{ sec}$  for the 0.5A fuse (not enough) and  $2 \times 10^{-2}$  for the 0.75A fuse (more than enough). Therefore, 0.75A fuse should be chosen for this application, see Figure 2c.

#### FUSE PRE-ARCING JOULE INTEGRALS vs. PRE-ARCING TIME

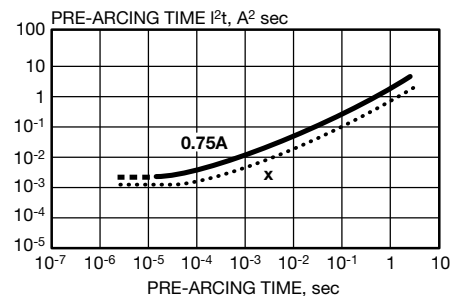

**Fig. 2c.** Choice of 0.75A fuse, example #2.

- Pre-arcing  $I^2t$
- ..... Maximum  $I^2t$  design rule
- x  $I^2t$  for sample switch-on pulse

### DESIGNING FOR CURRENT PULSE SITUATIONS (CONT.)

#### 3. Trapezoidal current pulse

The Joule integral for a trapezoidal pulse is

$$\left[ (I_{\min.})^2 + I_{\min.} \times (I_{\max.} - I_{\min.}) + \frac{(I_{\max.} - I_{\min.})^2}{3} \right] \times t,$$

see Fig. 3a.

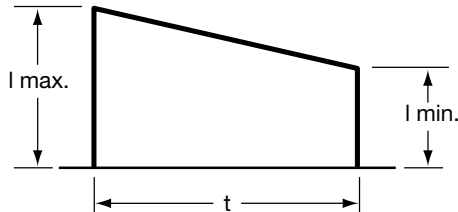

**Fig. 3a.** Trapezoidal pulse parameters for Joule integral calculation, example #3.

Thus, for current pulse in Figure 3b, the Joule integral is:

$$\{(0.56A)^2 + 0.56A \times (1A - 0.56A) + \frac{(1A - 0.56A)^2}{3}\} \times 3 \times 10^{-3}s = 1.9 \times 10^{-3}A^2sec.$$

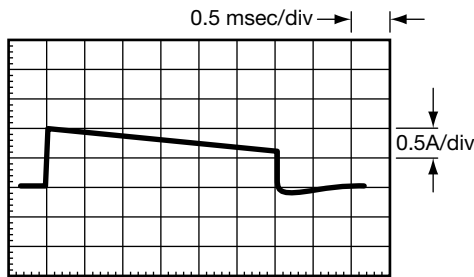

**Fig. 3b.** Trapezoidal pulse, example #3.

According to the  $I^2t$  graph on page 6, the 0.5A fuse should be chosen for this application, see Figure 3c.

#### FUSE PRE-ARCING JOULE INTEGRALS vs. PRE-ARCING TIME

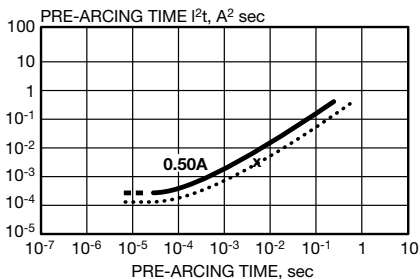
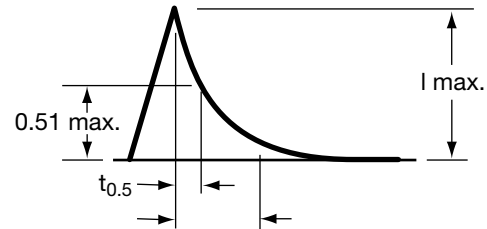

**Fig. 3c.** Choice of 0.5A fuse, example #3.

- Pre-arcing  $I^2t$
- ..... Maximum  $I^2t$  design rule
- X  $I^2t$  for sample switch-on pulse

#### 4. Lightning strike

A lightning strike pulse is shown in Figure 4a. After an initial linear rise, the current declines exponentially.



**Fig. 4a.** Lightning pulse parameters for Joule integral calculation, example #4.

Joule integral for the linear current rise is calculated as for a triangular pulse, see example #2.

The Joule integral for the exponential decline is

$$I_{\max.}^2 \times t_{0.5} \times (-1/2 \ln 0.5) = 0.72 I_{\max.}^2 \times t_{0.5}$$

Thus, for the sample lightning strike pulse in Figure 4b, the total Joule integral is:

$$(25A)^2 \times 2 \times 10^{-6}sec/3 + 0.72 \times (25A)^2 \times 10 \times 10^{-6}sec = 4.92 \times 10^{-3}A^2sec.$$

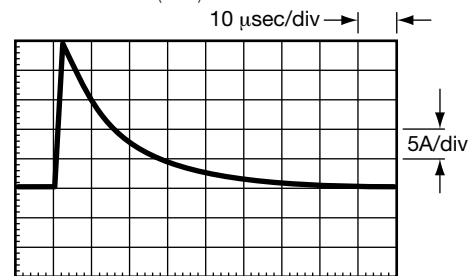

**Fig. 4b.** Lightning strike pulse, example #4.

For practical calculations, the duration of exponential decline may be assumed to be  $3t_{0.5}$ , because within this time 98.5% of the pulse energy is released. Thus, the total pulse duration in this example is 30  $\mu$ sec, and the 1.25A fuse should be chosen for this application, see Figure 4c.

#### FUSE PRE-ARCING JOULE INTEGRALS vs. PRE-ARCING TIME

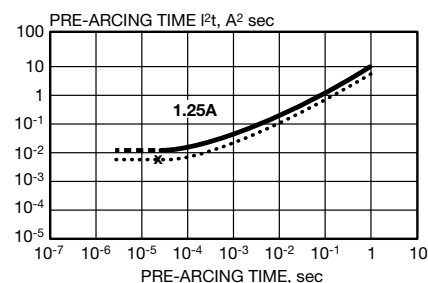

**Fig. 4c.** Choice of 0.5A fuse, example #4.

- Pre-arcing  $I^2t$
- ..... Maximum  $I^2t$  design rule
- X  $I^2t$  for sample switch-on pulse

### DESIGNING FOR CURRENT PULSE SITUATIONS (CONT.)

#### 5. Complex current pulse

If the pulse consists of several waveforms, all of them should be evaluated separately, and then the total Joule integral should be calculated as well.

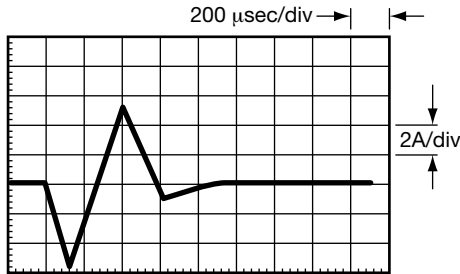

**Fig. 5a.** Complex pulse, example #5.

In Figure 5a, the Joule integral for the first triangle is  $[(4.67A)^2 \times 294 \times 10^{-6} \text{sec}] / 3 = 2.14 \times 10^{-3} \text{ A}^2\text{sec}$  and 0.75A fuse should meet this condition, see Figure 5b.

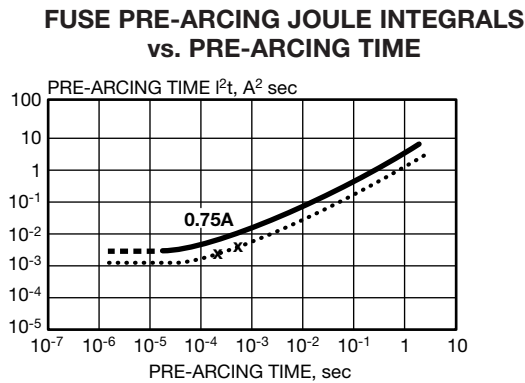

**Fig. 5b.** Choice of fuse, example #5.  
 — Pre-arcing  $I^2t$   
 ..... Maximum  $I^2t$  design rule  
 X  $I^2t$  for sample switch-on pulse

The Joule integral for the second triangle is  $[(5.33A)^2 \times 269 \times 10^{-6} \text{sec}] / 3 = 2.55 \times 10^{-3} \text{ A}^2\text{sec}$ , and 0.75A fuse is suitable for this case also, see Figure 5b.

However, for the whole pulse, the Joule integral is  $4.7 \times 10^{-3} \text{ A}^2\text{sec}$ , and the total duration is 563  $\mu\text{sec}$ . For the 0.75A fuse, the Joule integral is only  $8.6 \times 10^{-3} \text{ A}^2\text{sec}$  for this pulse duration, so the 1A fuse should be chosen for this application, see Figure 5b.

#### 6. Switch-on pulse and steady-state current

In Figure 6a, the switch-on pulse is a triangle pulse with a  $5.1 \times 10^{-3} \text{ A}^2\text{sec}$  Joule integral of 5 msec duration; the 0.75A fuse will meet this requirement, see Figure 6b.

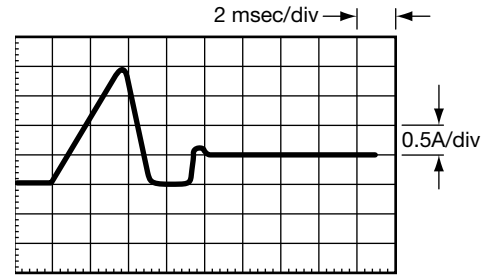

**Fig. 6a.** Switch-on pulse and steady-state current, example #6.

#### FUSE PRE-ARCING JOULE INTEGRALS vs. PRE-ARCING TIME

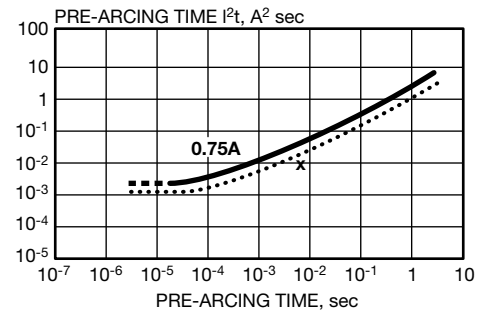

**Fig. 6b.** Choice of 0.75A fuse, example #6.  
 — Pre-arcing  $I^2t$   
 ..... Maximum  $I^2t$  design rule  
 X  $I^2t$  for sample switch-on pulse

The steady-state current is 0.5A, and 1A fuse is typically recommended to meet the steady-state condition. Based on steady-state current, the 1A fuse should be chosen for this application.

## Looking for pricing, stock, or lifecycle information?

Click below to explore more details on WIN SOURCE:

-  [View F1206A2R00FWTR on WIN SOURCE](#)
-  [AVX Corp/Kyocera Corp Information](#)

## Optimize Your Supply Chain with WIN SOURCE Solutions

-  Global Sourcing Solution
-  Obsolete Management
-  Cost Control Management
-  Shortage Management
-  Alternative Solution
-  Excess Inventory Management