



# Miniature Reflective Object Sensor

## QRE1113, QRE1113GR, QRE1114GR

### Features

- Phototransistor Output
- No Contact Surface Sensing
- Miniature Package
- Lead Form Style: Gull Wing
- Two Leadform Options:
  - ◆ Through Hole (QRE1113)
  - ◆ SMT Gull Wing (QRE1113GR & QRE1114GR)
- Two Packaging Options:
  - ◆ Tube (QRE1113)
  - ◆ Tape and Reel (QRE1113GR & QRE1114GR)

### MAXIMUM RATINGS ( $T_A = 25^\circ\text{C}$ unless otherwise noted)

Symbol	Parameter	Value	Unit
$T_{OPR}$	Operating Temperature	-40 to +85	$^\circ\text{C}$
$T_{STG}$	Storage Temperature	-40 to +90	$^\circ\text{C}$
$T_{SOL-I}$	Soldering Temperature (Iron) (Notes 2, 3, 4)	240 for 5 s	$^\circ\text{C}$
$T_{SOL-F}$	Soldering Temperature (Flow) (Notes 3, 4)	260 for 10 s	$^\circ\text{C}$

### EMITTER

$I_F$	Continuous Forward Current	50	mA
$V_R$	Reverse Voltage	5	V
$I_{FP}$	Peak Forward Current (Note 5)	1	A
$P_D$	Power Dissipation (Note 1)	75	mW

### SENSOR

$V_{CEO}$	Collector-Emitter Voltage	30	V
$V_{ECO}$	Emitter-Collector Voltage	5	V
$I_C$	Collector Current	20	mA
$P_D$	Power Dissipation (Note 1)	50	mW

Stresses exceeding those listed in the Maximum Ratings table may damage the device. If any of these limits are exceeded, device functionality should not be assumed, damage may occur and reliability may be affected.

1. Derate power dissipation linearly 1.00 mW/ $^\circ\text{C}$  above 25 $^\circ\text{C}$ .
2. RMA flux is recommended.
3. Methanol or isopropyl alcohols are recommended as cleaning agents.
4. Soldering iron 1/16" (1.6 mm) from housing.
5. Pulse conditions:  $t_p = 100 \mu\text{s}$ ;  $T = 10 \text{ ms}$ .

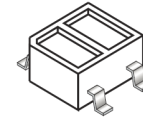
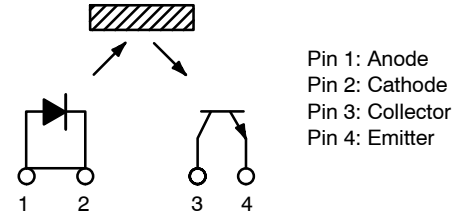

REFLECTIVE RECTANGULAR SURFACE MOUNT CASE 100CY

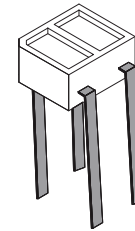

REFLECTIVE RECTANGULAR THROUGH HOLE CASE 100AQ

### ORDERING INFORMATION

Device	Package	Shipping <sup>†</sup>
QRE1113	Reflective Rectangular (Through Hole)	1600 / Tube
QRE1113GR & QRE1114GR	Reflective Rectangular (Surface Mount)	1000 / Tape & Reel

<sup>†</sup>For information on tape and reel specifications, including part orientation and tape sizes, please refer to our Tape and Reel Packaging Specifications Brochure, BRD8011/D.

# QRE1113, QRE1113GR, QRE1114GR

## ELECTRICAL/OPTICAL CHARACTERISTICS ( $T_A = 25^\circ\text{C}$ unless otherwise noted)

Symbol	Parameter	Conditions	Min	Typ	Max	Unit
<b>INPUT DIODE</b>						
$V_F$	Forward Voltage	$I_F = 20\text{ mA}$		1.2	1.6	V
$I_R$	Reverse Leakage Current	$V_R = 5\text{ V}$			10	$\mu\text{A}$
$\lambda_{PE}$	Peak Emission Wavelength	$I_F = 20\text{ mA}$		940		nm

## OUTPUT TRANSISTOR

$I_D$	Collector-Emitter Dark Current	$I_F = 0\text{ mA}, V_{CE} = 20\text{ V}$			100	nA
-------	--------------------------------	---	--	--	-----	----

## COUPLED

$I_{C(ON)}$	On-State Collector Current	$I_F = 20\text{ mA}, V_{CE} = 5\text{ V}$ (Note 6)	QRE1113 & QRE1113GR	0.10	0.90		mA
			QRE1114GR	0.30		0.60	mA
$I_{CX}$	Cross-Talk Collector Current	$I_F = 20\text{ mA}, V_{CE} = 5\text{ V}$ (Note 7)			1	$\mu\text{A}$	
$V_{CE(SAT)}$	Saturation Voltage	$I_F = 20\text{ mA}, I_C = 50\text{ }\mu\text{A}$ (Note 6)			0.3	V	
$t_r$	Rise Time	$V_{CC} = 5\text{ V}, I_{C(ON)} = 100\text{ }\mu\text{A}, R_L = 1\text{ k}\Omega$		20		$\mu\text{s}$	
$t_f$	Fall Time			20		$\mu\text{s}$	

Product parametric performance is indicated in the Electrical Characteristics for the listed test conditions, unless otherwise noted. Product performance may not be indicated by the Electrical Characteristics if operated under different conditions.

6. Measured using an aluminum alloy mirror at  $d = 1\text{ mm}$ .

7. No reflective surface at close proximity.

## REFLOW PROFILE

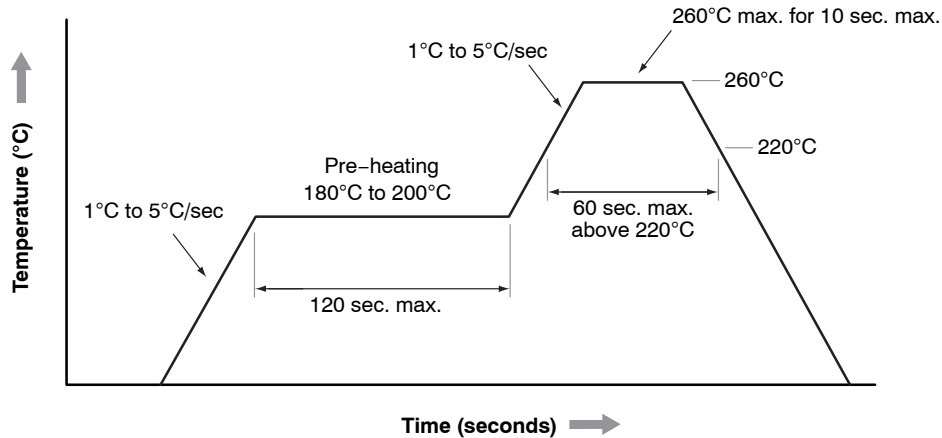
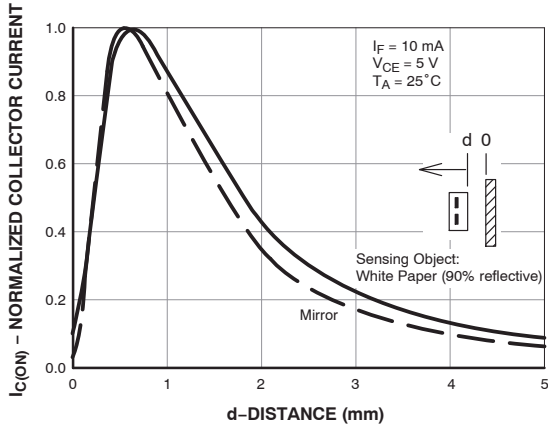

Figure 1. Reflow Profile

# QRE1113, QRE1113GR, QRE1114GR

## TYPICAL PERFORMANCE CURVES



**Figure 2. Normalized Collector Current vs. Distance between Device and Reflector**

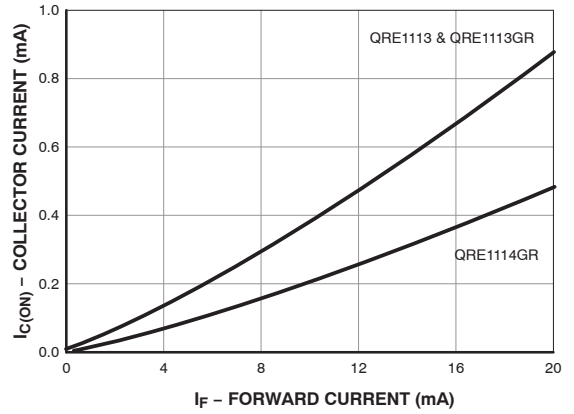

**Figure 3. Collector Current vs. Forward Current**

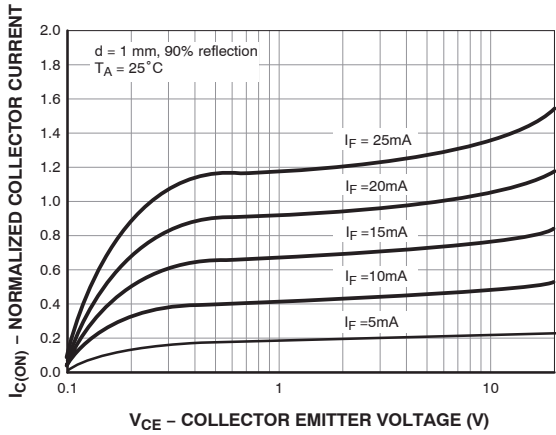

**Figure 4. Normalized Collector Current vs. Collector to Emitter Voltage**

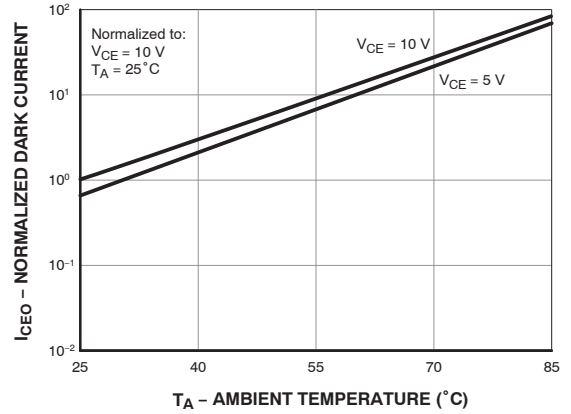

**Figure 5. Collector Emitter Dark Current (Normalized) vs. Ambient Temperature**

# QRE1113, QRE1113GR, QRE1114GR

## TYPICAL PERFORMANCE CURVES (CONTINUED)

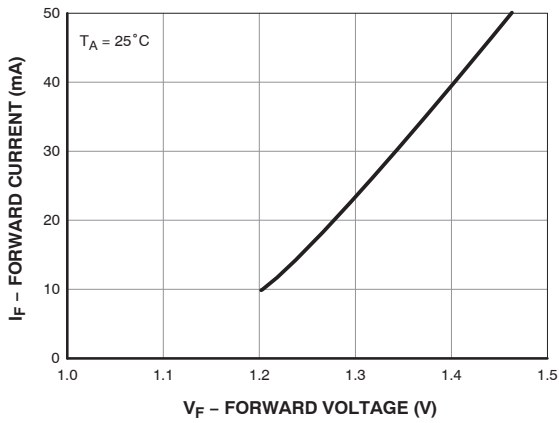

Figure 6. Forward Current vs. Forward Voltage

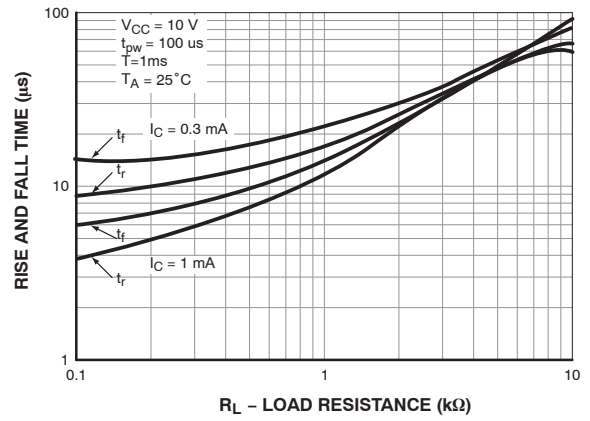

Figure 7. Rise and Fall Time vs. Load Resistance

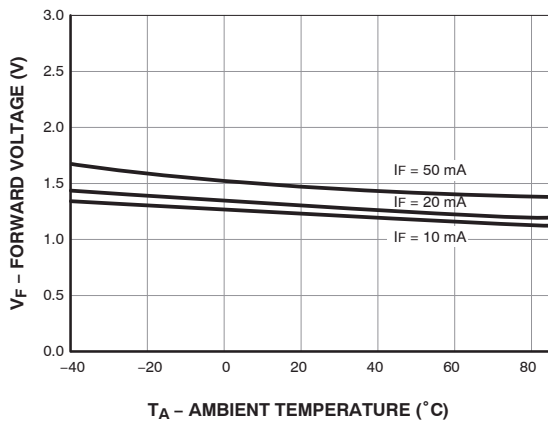

Figure 8. Forward Voltage vs. Ambient Temperature

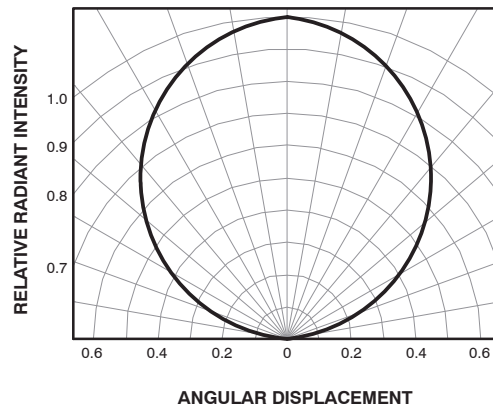

Figure 9. Radiation Diagram

# QRE1113, QRE1113GR, QRE1114GR

## TAPING DIMENSIONS FOR GR OPTION

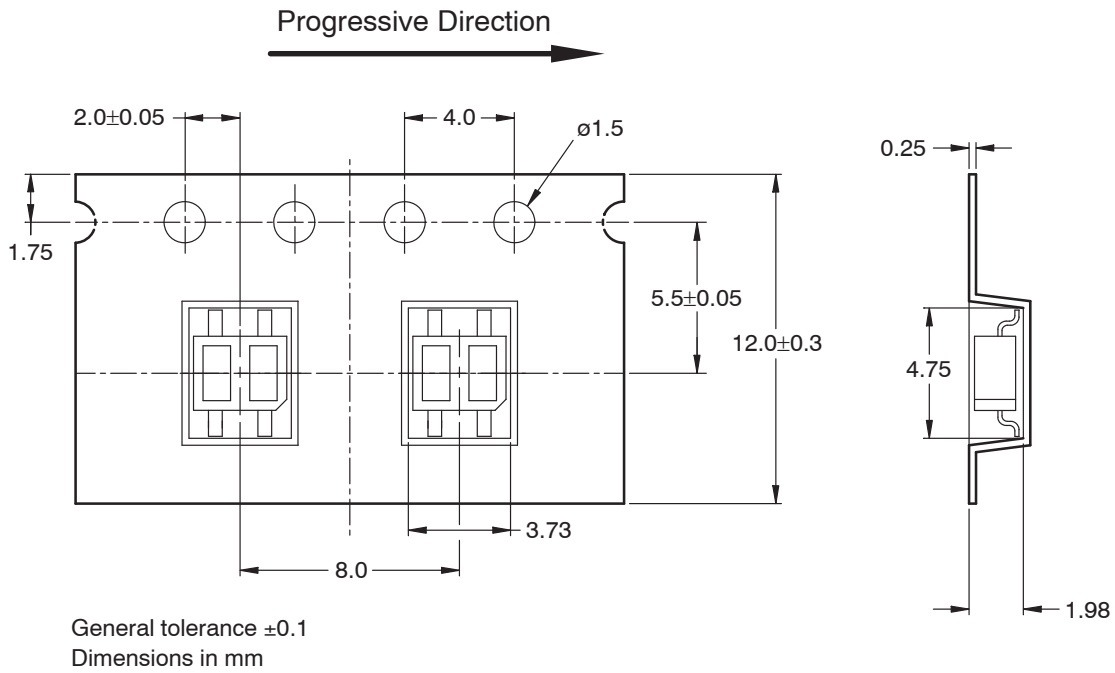

Figure 10. Taping Dimensions for GR Option

## REEL DIMENSIONS

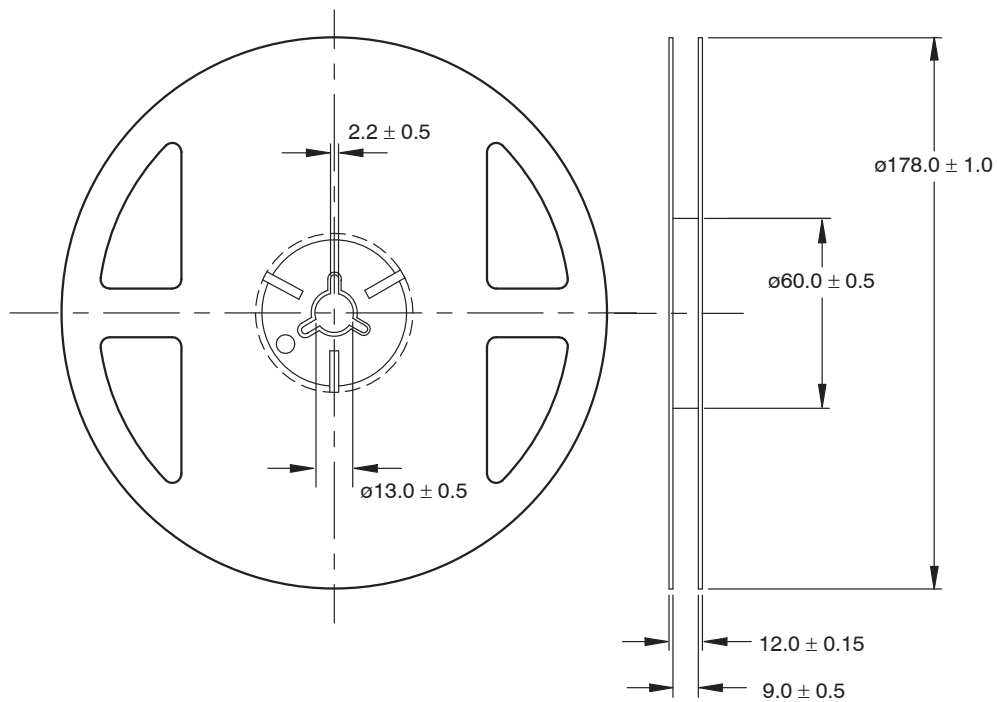

Figure 11. Reel Dimensions

## QRE1113, QRE1113GR, QRE1114GR

### Precautionary Notes

1. Refer to application note AND8003/D, "Storage and Handling of Dry Packed Surface Mounted Devices" for details of handling procedure.
2. Product soldering terminals are silver plated and oxidization may occur with prolonged exposure to ambient environment. Oxidized terminal may have poor solderability performance. Keep unsealed devices in moisture barrier bag sealed with desiccant or in dry cabinet at <5% relative humidity.
3. Store PCB in sealed moisture barrier bag together with desiccant or store in dry cabinet at <5% relative humidity. Mounted device that has been exposed to ambient environment for long period of time may suffer moisture related damage if PCB is subjected to subsequent high temperature processes.

**REFLECTIVE RECTANGULAR THROUGH HOLE**  
**CASE 100AQ**  
**ISSUE O**

DATE 30 SEP 2016

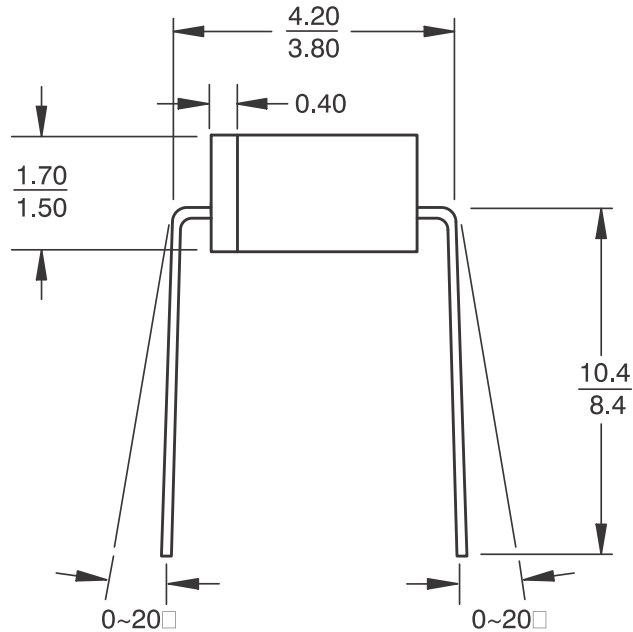
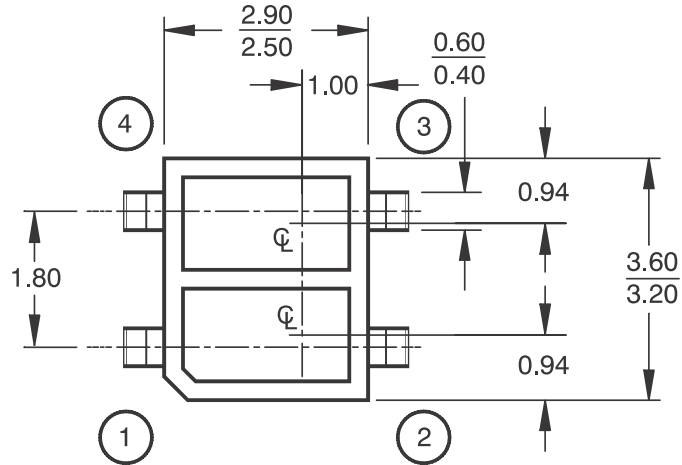

**Notes:**

1. Dimensions for all drawings are in millimeters.
2. Tolerance of  $\pm 0.15\text{mm}$  on all non-nominal dimensions

<b>DOCUMENT NUMBER:</b>	<b>98AON13409G</b>	Electronic versions are uncontrolled except when accessed directly from the Document Repository. Printed versions are uncontrolled except when stamped "CONTROLLED COPY" in red.
<b>DESCRIPTION:</b>	<b>REFLECTIVE RECTANGULAR THROUGH HOLE</b>	<b>PAGE 1 OF 1</b>

ON Semiconductor and  are trademarks of Semiconductor Components Industries, LLC dba ON Semiconductor or its subsidiaries in the United States and/or other countries. ON Semiconductor reserves the right to make changes without further notice to any products herein. ON Semiconductor makes no warranty, representation or guarantee regarding the suitability of its products for any particular purpose, nor does ON Semiconductor assume any liability arising out of the application or use of any product or circuit, and specifically disclaims any and all liability, including without limitation special, consequential or incidental damages. ON Semiconductor does not convey any license under its patent rights nor the rights of others.

**ARUSM-313 / REFLECTIVE RECTANGULAR SURFACE MOUNT**  
CASE 100CY  
ISSUE O

DATE 31 JAN 2017

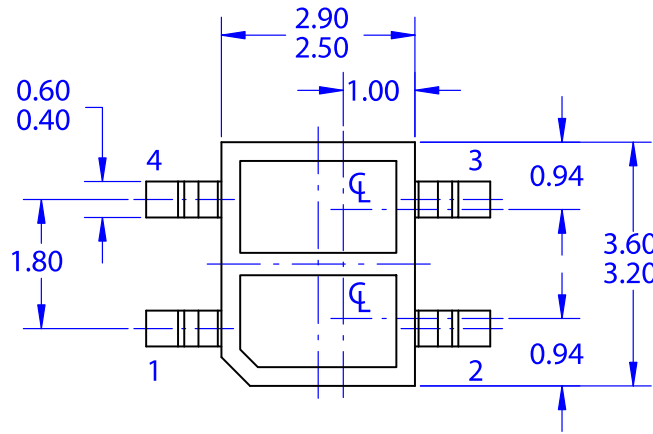

TOP VIEW

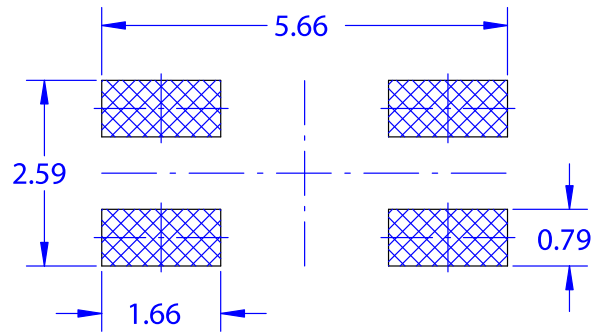

LAND PATTERN RECOMMENDATION

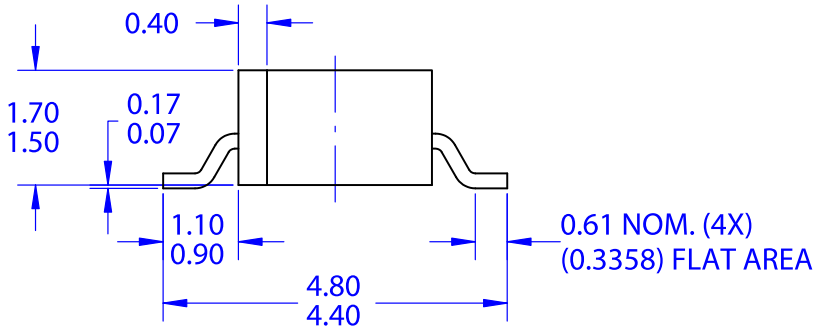

SIDE VIEW

- NOTES:  
A. NO INDUSTRY STANDARD APPLIES TO THIS PACKAGE  
B. ALL DIMENSIONS ARE IN MILLIMETERS  
C. TOLERANCE OF  $\pm 0.15\text{MM}$  ON ALL NON-NOMINAL DIMENSIONS

<b>DOCUMENT NUMBER:</b>	<b>98AON13407G</b>	Electronic versions are uncontrolled except when accessed directly from the Document Repository. Printed versions are uncontrolled except when stamped "CONTROLLED COPY" in red.
<b>DESCRIPTION:</b>	<b>ARUSM-313 / REFLECTIVE RECTANGULAR SURFACE MOUNT</b>	<b>PAGE 1 OF 1</b>

ON Semiconductor and are trademarks of Semiconductor Components Industries, LLC dba ON Semiconductor or its subsidiaries in the United States and/or other countries. ON Semiconductor reserves the right to make changes without further notice to any products herein. ON Semiconductor makes no warranty, representation or guarantee regarding the suitability of its products for any particular purpose, nor does ON Semiconductor assume any liability arising out of the application or use of any product or circuit, and specifically disclaims any and all liability, including without limitation special, consequential or incidental damages. ON Semiconductor does not convey any license under its patent rights nor the rights of others.

**onsemi**, **Onsemi**, and other names, marks, and brands are registered and/or common law trademarks of Semiconductor Components Industries, LLC dba "**onsemi**" or its affiliates and/or subsidiaries in the United States and/or other countries. **onsemi** owns the rights to a number of patents, trademarks, copyrights, trade secrets, and other intellectual property. A listing of **onsemi**'s product/patent coverage may be accessed at [www.onsemi.com/site/pdf/Patent-Marking.pdf](http://www.onsemi.com/site/pdf/Patent-Marking.pdf). **onsemi** reserves the right to make changes at any time to any products or information herein, without notice. The information herein is provided "as-is" and **onsemi** makes no warranty, representation or guarantee regarding the accuracy of the information, product features, availability, functionality, or suitability of its products for any particular purpose, nor does **onsemi** assume any liability arising out of the application or use of any product or circuit, and specifically disclaims any and all liability, including without limitation special, consequential or incidental damages. Buyer is responsible for its products and applications using **onsemi** products, including compliance with all laws, regulations and safety requirements or standards, regardless of any support or applications information provided by **onsemi**. "Typical" parameters which may be provided in **onsemi** data sheets and/or specifications can and do vary in different applications and actual performance may vary over time. All operating parameters, including "Typicals" must be validated for each customer application by customer's technical experts. **onsemi** does not convey any license under any of its intellectual property rights nor the rights of others. **onsemi** products are not designed, intended, or authorized for use as a critical component in life support systems or any FDA Class 3 medical devices or medical devices with a same or similar classification in a foreign jurisdiction or any devices intended for implantation in the human body. Should Buyer purchase or use **onsemi** products for any such unintended or unauthorized application, Buyer shall indemnify and hold **onsemi** and its officers, employees, subsidiaries, affiliates, and distributors harmless against all claims, costs, damages, and expenses, and reasonable attorney fees arising out of, directly or indirectly, any claim of personal injury or death associated with such unintended or unauthorized use, even if such claim alleges that **onsemi** was negligent regarding the design or manufacture of the part. **onsemi** is an Equal Opportunity/Affirmative Action Employer. This literature is subject to all applicable copyright laws and is not for resale in any manner.

## ADDITIONAL INFORMATION

### TECHNICAL PUBLICATIONS:



Technical Library: [www.onsemi.com/design/resources/technical-documentation](http://www.onsemi.com/design/resources/technical-documentation)  
onsemi Website: [www.onsemi.com](http://www.onsemi.com)

### ONLINE SUPPORT: [www.onsemi.com/support](http://www.onsemi.com/support)

For additional information, please contact your local Sales Representative at [www.onsemi.com/support/sales](http://www.onsemi.com/support/sales)

## Looking for pricing, stock, or lifecycle information?

Click below to explore more details on WIN SOURCE:

-  [View QRE1113 on WIN SOURCE](#)
-  [ON Semiconductor](#) Information

## Optimize Your Supply Chain with WIN SOURCE Solutions

-  Global Sourcing Solution
-  Obsolete Management
-  Cost Control Management
-  Shortage Management
-  Alternative Solution
-  Excess Inventory Management