



**THE DATASHEET OF
NCP300LSN33T1**



NCP300, NCP301

Voltage Detector Series

The NCP300 and NCP301 series are second generation ultra-low current voltage detectors. These devices are specifically designed for use as reset controllers in portable microprocessor based systems where extended battery life is paramount.

Each series features a highly accurate undervoltage detector with hysteresis which prevents erratic system reset operation as the comparator threshold is crossed.

The NCP300 series consists of complementary output devices that are available with either an active high or active low reset output. The NCP301 series has an open drain N-Channel output with either an active high or active low reset output.

The NCP300 and NCP301 device series are available in the Thin TSOP-5 package with standard undervoltage thresholds. Additional thresholds that range from 0.9 V to 4.9 V in 100 mV steps can be manufactured.

Features

- Quiescent Current of 0.5 μ A Typical
- High Accuracy Undervoltage Threshold of 2.0%
- Wide Operating Voltage Range of 0.8 V to 10 V
- Complementary or Open Drain Reset Output
- Active Low or Active High Reset Output
- Specified Over the -40°C to $+125^{\circ}\text{C}$ Temperature Range (Except for Voltage Options from 0.9 to 1.1 V)
- NCV Prefix for Automotive and Other Applications Requiring Unique Site and Control Change Requirements; AEC-Q100 Qualified and PPAP Capable
- These Devices are Pb-Free and are RoHS Compliant

Typical Applications

- Microprocessor Reset Controller
- Low Battery Detection
- Power Fail Indicator
- Battery Backup Detection

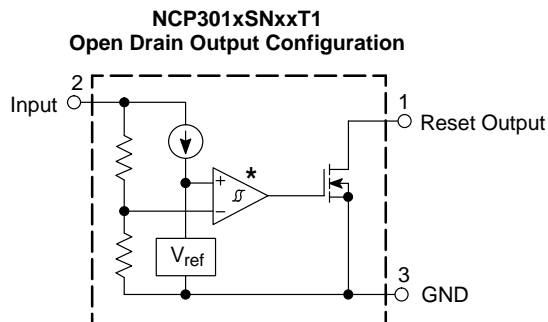
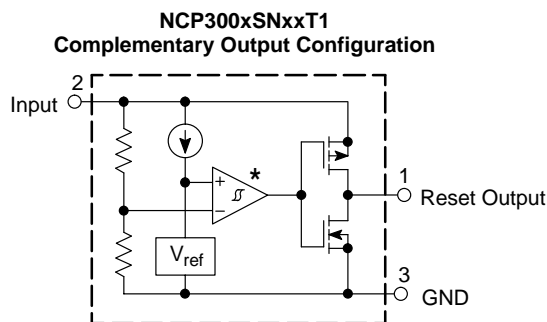

* The representative block diagrams depict active low reset output 'L' suffix devices. The comparator inputs are interchanged for the active high output 'H' suffix devices.

This device contains 25 active transistors.

Figure 1. Representative Block Diagrams



ON Semiconductor®

www.onsemi.com

MARKING DIAGRAM



TSOP-5/
SOT23-5
CASE 483

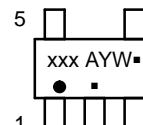

- xxx = Specific Device Code
- A = Assembly Location
- Y = Year
- W = Work Week
- = Pb-Free Package

(Note: Microdot may be in either location)

PIN CONNECTIONS

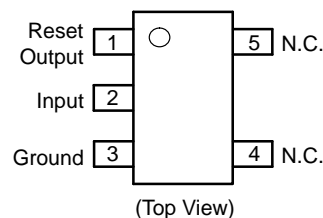

ORDERING INFORMATION

See detailed ordering and shipping information in the ordering information section on page 21 of this data sheet.

NCP300, NCP301

MAXIMUM RATINGS

Rating	Symbol	Value	Unit
Input Power Supply Voltage (Pin 2)	V_{in}	12	V
Output Voltage (Pin 1) Complementary, NCP300 N-Channel Open Drain, NCP301	V_{OUT}	-0.3 to $V_{in} + 0.3$ -0.3 to 12	V
Output Current (Pin 1) (Note 2)	I_{OUT}	70	mA
Thermal Resistance Junction-to-Air	$R_{\theta JA}$	250	°C/W
Maximum Junction Temperature	T_J	+150	°C
Operating Ambient Temperature Range All Voltage Options: 0.9 V to 1.1 V All Voltage Options: 1.2 V to 4.9 V	T_A T_A	-40 to +85 -40 to +125	°C °C
Storage Temperature Range	T_{stg}	-55 to +150	°C
Moisture Sensitivity Level	MSL	1	
Latchup Performance (Note 3) Positive Negative	$I_{LATCHUP}$	200 200	mA

Stresses exceeding those listed in the Maximum Ratings table may damage the device. If any of these limits are exceeded, device functionality should not be assumed, damage may occur and reliability may be affected.

- This device series contains ESD protection and exceeds the following tests:
Human Body Model 2000 V per MIL-STD-883, Method 3015.
Machine Model Method 200 V.
- The maximum package power dissipation limit must not be exceeded.

$$P_D = \frac{T_{J(max)} - T_A}{R_{\theta JA}}$$

- Maximum ratings per JEDEC standard JESD78.

NCP300, NCP301

ELECTRICAL CHARACTERISTICS (For all values $T_A = -40^{\circ}\text{C}$ to $+125^{\circ}\text{C}$, unless otherwise noted.)

Characteristic	Symbol	Min	Typ	Max	Unit
NCP300/1 – 0.9 / NCV300/1 – 0.9 ($T_A = 25^{\circ}\text{C}$ for voltage options from 0.9 to 1.1 V)					
Detector Threshold (Pin 2, V_{in} Decreasing)	V_{DET-}	0.882	0.900	0.918	V
Detector Threshold Hysteresis (Pin 2, V_{in} Increasing)	V_{HYS}	0.027	0.045	0.063	V
Supply Current (Pin 2) ($V_{in} = 0.8\text{ V}$) ($V_{in} = 2.9\text{ V}$)	I_{in}	– –	0.20 0.45	0.6 1.2	μA
Maximum Operating Voltage (Pin 2)	$V_{in(max)}$	–	–	10	V
Minimum Operating Voltage (Pin 2) ($T_A = -40^{\circ}\text{C}$ to 85°C)	$V_{in(min)}$	– –	0.55 0.65	0.70 0.80	V
Reset Output Current (Pin 1, Active Low 'L' Suffix Devices) N-Channel Sink Current, NCP300, NCP301 ($V_{OUT} = 0.05\text{ V}$, $V_{in} = 0.70\text{ V}$) ($V_{OUT} = 0.50\text{ V}$, $V_{in} = 0.85\text{ V}$) P-Channel Source Current, NCP300 ($V_{OUT} = 2.4\text{ V}$, $V_{in} = 4.5\text{ V}$)	I_{OUT}	0.01 0.05 1.0	0.05 0.50 6.0	– – –	mA
Reset Output Current (Pin 1, Active High 'H' Suffix Devices) N-Channel Sink Current, NCP300, NCP301 ($V_{OUT} = 0.5\text{ V}$, $V_{in} = 1.5\text{ V}$) P-Channel Source Current, NCP300 ($V_{OUT} = 0.4\text{ V}$, $V_{in} = 0.7\text{ V}$) ($V_{OUT} = \text{GND}$, $V_{in} = 0.8\text{ V}$)	I_{OUT}	1.05 0.011 0.014	2.5 0.04 0.08	– – –	mA
Propagation Delay Input to Output (Figure 2) Complementary Output NCP300 Series Output Transition, High to Low Output Transition, Low to High N-Channel Open Drain NCP301 Series Output Transition, High to Low Output Transition, Low to High	t_{pHL} t_{pLH} t_{pHL} t_{pLH}	– – – –	97 77 97 –	– 300 – 300	μs
NCP300/1 – 1.8 / NCV300/1 – 1.8					
Detector Threshold (Pin 2, V_{in} Decreasing) ($T_A = 25^{\circ}\text{C}$) ($T_A = -40^{\circ}\text{C}$ to 125°C)	V_{DET-}	1.764 1.746	1.80 –	1.836 1.854	V
Detector Threshold Hysteresis (Pin 2, V_{in} Increasing)	V_{HYS}	0.054	0.090	0.126	V
Supply Current (Pin 2) ($V_{in} = 1.7\text{ V}$) ($V_{in} = 3.8\text{ V}$)	I_{in}	– –	0.23 0.48	0.7 1.3	μA
Maximum Operating Voltage (Pin 2)	$V_{in(max)}$	–	–	10	V
Minimum Operating Voltage (Pin 2) ($T_A = 25^{\circ}\text{C}$) ($T_A = -40^{\circ}\text{C}$ to 125°C)	$V_{in(min)}$	– –	0.55 0.65	0.70 0.80	V
Reset Output Current (Pin 1, Active Low 'L' Suffix Devices) N-Channel Sink Current, NCP300, NCP301 ($V_{OUT} = 0.05\text{ V}$, $V_{in} = 0.70\text{ V}$) ($V_{OUT} = 0.50\text{ V}$, $V_{in} = 1.5\text{ V}$) P-Channel Source Current, NCP300 ($V_{OUT} = 2.4\text{ V}$, $V_{in} = 4.5\text{ V}$)	I_{OUT}	0.01 1.0 1.0	0.05 2.0 6.0	– – –	mA
Reset Output Current (Pin 1, Active High 'H' Suffix Devices) N-Channel Sink Current, NCP300, NCP301 ($V_{OUT} = 0.5\text{ V}$, $V_{in} = 5.0\text{ V}$) P-Channel Source Current, NCP300 ($V_{OUT} = 0.4\text{ V}$, $V_{in} = 0.7\text{ V}$) ($V_{OUT} = \text{GND}$, $V_{in} = 1.5\text{ V}$)	I_{OUT}	6.3 0.011 0.525	11 0.04 0.6	– – –	mA
Propagation Delay Input to Output (Figure 2) Complementary Output NCP300 Series Output Transition, High to Low Output Transition, Low to High	t_{pHL} t_{pLH}	– –	73 94	– 300	μs

NCP300, NCP301

ELECTRICAL CHARACTERISTICS (continued) (For all values $T_A = -40^{\circ}\text{C}$ to $+125^{\circ}\text{C}$, unless otherwise noted.)

Characteristic	Symbol	Min	Typ	Max	Unit
NCP300/1 – 1.8 / NCV300/1 – 1.8					
N-Channel Open Drain NCP301 Series Output Transition, High to Low	t_{pHL}	–	73	–	
Output Transition, Low to High	t_{pLH}	–	–	300	
NCP300/1 – 2.0 / NCV300/1 – 2.0					
Detector Threshold (Pin 2, V_{in} Decreasing) ($T_A = 25^{\circ}\text{C}$) ($T_A = -40^{\circ}\text{C}$ to 125°C)	V_{DET-}	1.96 1.94	2.00 –	2.04 2.06	V
Detector Threshold Hysteresis (Pin 2, V_{in} Increasing)	V_{HYS}	0.06	0.10	0.14	V
Supply Current (Pin 2) ($V_{in} = 1.9\text{ V}$) ($V_{in} = 4.0\text{ V}$)	I_{in}	– –	0.23 0.48	0.8 1.3	μA
Maximum Operating Voltage (Pin 2)	$V_{in(max)}$	–	–	10	V
Minimum Operating Voltage (Pin 2) ($T_A = 25^{\circ}\text{C}$) ($T_A = -40^{\circ}\text{C}$ to 125°C)	$V_{in(min)}$	– –	0.55 0.65	0.70 0.80	V
Reset Output Current (Pin 1, Active Low 'L' Suffix Devices) N-Channel Sink Current, NCP300, NCP301 ($V_{OUT} = 0.05\text{V}$, $V_{in} = 0.70\text{V}$) ($V_{OUT} = 0.50\text{V}$, $V_{in} = 1.5\text{V}$) P-Channel Source Current, NCP300 ($V_{OUT} = 2.4\text{V}$, $V_{in} = 4.5\text{V}$)	I_{OUT}	0.01 1.0 1.0	0.14 3.5 9.7	– – –	mA
Reset Output Current (Pin 1, Active High 'H' Suffix Devices) N-Channel Sink Current, NCP300, NCP301 ($V_{OUT} = 0.5\text{ V}$, $V_{in} = 5.0\text{ V}$) P-Channel Source Current, NCP300 ($V_{OUT} = 0.4\text{ V}$, $V_{in} = 0.7\text{ V}$) ($V_{OUT} = \text{GND}$, $V_{in} = 1.5\text{ V}$)	I_{OUT}	6.3 0.011 0.525	11 0.04 0.6	– – –	mA
Propagation Delay Input to Output (Figure 2) Complementary Output NCP300 Series Output Transition, High to Low Output Transition, Low to High N-Channel Open Drain NCP301 Series Output Transition, High to Low Output Transition, Low to High	t_{pHL} t_{pLH} t_{pHL} t_{pLH}	– – – –	55 108 55 –	– 300 – 300	μs
NCP300/1 – 2.2 / NCV300/1 – 2.2					
Detector Threshold (Pin 2, V_{in} Decreasing) ($T_A = 25^{\circ}\text{C}$) ($T_A = -40^{\circ}\text{C}$ to 125°C)	V_{DET-}	2.156 2.134	2.2 –	2.244 2.266	V
Detector Threshold Hysteresis (Pin 2, V_{in} Increasing)	V_{HYS}	0.066	0.110	0.154	V
Supply Current (Pin 2) ($V_{in} = 2.1\text{ V}$) ($V_{in} = 4.2\text{ V}$)	I_{in}	– –	0.23 0.48	0.8 1.3	μA
Maximum Operating Voltage (Pin 2)	$V_{in(max)}$	–	–	10	V
Minimum Operating Voltage (Pin 2) ($T_A = 25^{\circ}\text{C}$) ($T_A = -40^{\circ}\text{C}$ to 125°C)	$V_{in(min)}$	– –	0.55 0.65	0.70 0.80	V
Reset Output Current (Pin 1, Active Low 'L' Suffix Devices) N-Channel Sink Current, NCP300, NCP301 ($V_{OUT} = 0.05\text{V}$, $V_{in} = 0.70\text{V}$) ($V_{OUT} = 0.50\text{V}$, $V_{in} = 1.5\text{V}$) P-Channel Source Current, NCP300 ($V_{OUT} = 2.4\text{V}$, $V_{in} = 4.5\text{V}$)	I_{OUT}	0.01 1.0 1.0	0.14 3.5 9.7	– – –	mA
Reset Output Current (Pin 1, Active High 'H' Suffix Devices) N-Channel Sink Current, NCP300, NCP301 ($V_{OUT} = 0.5\text{ V}$, $V_{in} = 5.0\text{ V}$)	I_{OUT}	6.3	11	–	mA

NCP300, NCP301

ELECTRICAL CHARACTERISTICS (continued) (For all values $T_A = -40^{\circ}\text{C}$ to $+125^{\circ}\text{C}$, unless otherwise noted.)

Characteristic	Symbol	Min	Typ	Max	Unit
NCP300/1 – 2.2 / NCV300/1 – 2.2					
P-Channel Source Current, NCP300 ($V_{OUT} = 0.4\text{ V}$, $V_{in} = 0.7\text{ V}$) ($V_{OUT} = \text{GND}$, $V_{in} = 1.5\text{ V}$)		0.011 0.525	0.04 0.6	– –	
Propagation Delay Input to Output (Figure 2) Complementary Output NCP300 Series Output Transition, High to Low Output Transition, Low to High N-Channel Open Drain NCP301 Series Output Transition, High to Low Output Transition, Low to High	t_{pHL} t_{pLH} t_{pHL} t_{pLH}	– – – –	55 108 55 –	– 300 – 300	μs
NCP300/1 – 2.7 / NCV300/1 – 2.7					
Detector Threshold (Pin 2, V_{in} Decreasing) ($T_A = 25^{\circ}\text{C}$) ($T_A = -40^{\circ}\text{C}$ to 125°C)	V_{DET-}	2.646 2.619	2.700 –	2.754 2.781	V
Detector Threshold Hysteresis (Pin 2, V_{in} Increasing)	V_{HYS}	0.081	0.135	0.189	V
Supply Current (Pin 2) ($V_{in} = 2.6\text{ V}$) ($V_{in} = 4.7\text{ V}$)	I_{in}	– –	0.25 0.50	0.8 1.3	μA
Maximum Operating Voltage (Pin 2)	$V_{in(max)}$	–	–	10	V
Minimum Operating Voltage (Pin 2) ($T_A = 25^{\circ}\text{C}$) ($T_A = -40^{\circ}\text{C}$ to 125°C)	$V_{in(min)}$	– –	0.55 0.65	0.70 0.80	V
Reset Output Current (Pin 1, Active Low 'L' Suffix Devices) N-Channel Sink Current, NCP300, NCP301 ($V_{OUT} = 0.05\text{V}$, $V_{in} = 0.70\text{V}$) ($V_{OUT} = 0.50\text{V}$, $V_{in} = 1.5\text{V}$) P-Channel Source Current, NCP300 ($V_{OUT} = 2.4\text{V}$, $V_{in} = 4.5\text{V}$)	I_{OUT}	0.01 1.0 1.0	0.14 3.5 9.7	– – –	mA
Reset Output Current (Pin 1, Active High 'H' Suffix Devices) N-Channel Sink Current, NCP300, NCP301 ($V_{OUT} = 0.5\text{ V}$, $V_{in} = 5.0\text{ V}$) P-Channel Source Current, NCP300 ($V_{OUT} = 0.4\text{ V}$, $V_{in} = 0.7\text{ V}$) ($V_{OUT} = \text{GND}$, $V_{in} = 1.5\text{ V}$)	I_{OUT}	6.3 0.011 0.525	11 0.04 0.6	– – –	mA
Propagation Delay Input to Output (Figure 2) Complementary Output NCP300 Series Output Transition, High to Low Output Transition, Low to High N-Channel Open Drain NCP301 Series Output Transition, High to Low Output Transition, Low to High	t_{pHL} t_{pLH} t_{pHL} t_{pLH}	– – – –	55 115 55 –	– 300 – 300	μs
NCP300/1 – 2.8 / NCV300/1 – 2.8					
Detector Threshold (Pin 2, V_{in} Decreasing) ($T_A = 25^{\circ}\text{C}$) ($T_A = -40^{\circ}\text{C}$ to 125°C)	V_{DET-}	2.744 2.716	2.8 –	2.856 2.884	V
Detector Threshold Hysteresis (Pin 2, V_{in} Increasing)	V_{HYS}	0.084	0.14	0.196	V
Supply Current (Pin 2) ($V_{in} = 2.7\text{ V}$) ($V_{in} = 4.8\text{ V}$)	I_{in}	– –	0.25 0.5	0.8 1.3	μA
Maximum Operating Voltage (Pin 2)	$V_{in(max)}$	–	–	10	V
Minimum Operating Voltage (Pin 2) ($T_A = 25^{\circ}\text{C}$) ($T_A = -40^{\circ}\text{C}$ to 125°C)	$V_{in(min)}$	– –	0.55 0.65	0.7 0.8	V
Reset Output Current (Pin 1, Active Low 'L' Suffix Devices) N-Channel Sink Current, NCP300, NCP301 ($V_{OUT} = 0.05\text{V}$, $V_{in} = 0.70\text{V}$) ($V_{OUT} = 0.50\text{V}$, $V_{in} = 1.5\text{V}$)	I_{OUT}	0.01 1.0	0.14 3.5	– –	mA

NCP300, NCP301

ELECTRICAL CHARACTERISTICS (continued) (For all values $T_A = -40^\circ\text{C}$ to $+125^\circ\text{C}$, unless otherwise noted.)

Characteristic	Symbol	Min	Typ	Max	Unit
NCP300/1 – 2.8 / NCV300/1 – 2.8					
P-Channel Source Current, NCP300 ($V_{OUT} = 2.4\text{V}$, $V_{in} = 4.5\text{V}$)		1.0	9.7	–	
Reset Output Current (Pin 1, Active High 'H' Suffix Devices)	I_{OUT}				mA
N-Channel Sink Current, NCP300, NCP301 ($V_{OUT} = 0.5\text{V}$, $V_{in} = 5.0\text{V}$)		6.3	11	–	
P-Channel Source Current, NCP300 ($V_{OUT} = 0.4\text{V}$, $V_{in} = 0.7\text{V}$) ($V_{OUT} = \text{GND}$, $V_{in} = 1.5\text{V}$)		0.011 0.525	0.04 0.6	– –	
Propagation Delay Input to Output (Figure 2)					μs
Complementary Output NCP300 Series					
Output Transition, High to Low	t_{pHL}	–	55	–	
Output Transition, Low to High	t_{pLH}	–	115	300	
N-Channel Open Drain NCP301 Series					
Output Transition, High to Low	t_{pHL}	–	55	–	
Output Transition, Low to High	t_{pLH}	–	–	300	
NCP300/1 – 3.0 / NCV300/1 – 3.0					
Detector Threshold (Pin 2, V_{in} Decreasing) ($T_A = 25^\circ\text{C}$) ($T_A = -40^\circ\text{C}$ to 125°C)	V_{DET-}	2.94 2.91	3.00 –	3.06 3.09	V
Detector Threshold Hysteresis (Pin 2, V_{in} Increasing)	V_{HYS}	0.09	0.15	0.21	V
Supply Current (Pin 2) ($V_{in} = 2.87\text{V}$) ($V_{in} = 5.0\text{V}$)	I_{in}	– –	0.25 0.50	0.9 1.3	μA
Maximum Operating Voltage (Pin 2)	$V_{in(max)}$	–	–	10	V
Minimum Operating Voltage (Pin 2) ($T_A = 25^\circ\text{C}$) ($T_A = -40^\circ\text{C}$ to 125°C)	$V_{in(min)}$	– –	0.55 0.65	0.70 0.80	V
Reset Output Current (Pin 1, Active Low 'L' Suffix Devices)	I_{OUT}				mA
N-Channel Sink Current, NCP300, NCP301 ($V_{OUT} = 0.05\text{V}$, $V_{in} = 0.70\text{V}$) ($V_{OUT} = 0.50\text{V}$, $V_{in} = 1.5\text{V}$)		0.01 1.0	0.14 3.5	– –	
P-Channel Source Current, NCP300 ($V_{OUT} = 2.4\text{V}$, $V_{in} = 4.5\text{V}$)		1.0	9.7	–	
Reset Output Current (Pin 1, Active High 'H' Suffix Devices)	I_{OUT}				mA
N-Channel Sink Current, NCP300, NCP301 ($V_{OUT} = 0.5\text{V}$, $V_{in} = 5.0\text{V}$)		6.3	11	–	
P-Channel Source Current, NCP300 ($V_{OUT} = 0.4\text{V}$, $V_{in} = 0.7\text{V}$) ($V_{OUT} = \text{GND}$, $V_{in} = 1.5\text{V}$)		0.011 0.525	0.04 0.6	– –	
Propagation Delay Input to Output (Figure 2)					μs
Complementary Output NCP300 Series					
Output Transition, High to Low	t_{pHL}	–	49	–	
Output Transition, Low to High	t_{pLH}	–	115	300	
N-Channel Open Drain NCP301 Series					
Output Transition, High to Low	t_{pHL}	–	49	–	
Output Transition, Low to High	t_{pLH}	–	–	300	
NCP300/1 – 4.5 / NCV300/1 – 4.5					
Detector Threshold (Pin 2, V_{in} Decreasing) ($T_A = 25^\circ\text{C}$) ($T_A = -40^\circ\text{C}$ to 125°C)	V_{DET-}	4.410 4.365	4.500 –	4.590 4.635	V
Detector Threshold Hysteresis (Pin 2, V_{in} Increasing)	V_{HYS}	0.135	0.225	0.315	V
Supply Current (Pin 2) ($V_{in} = 4.34\text{V}$) ($V_{in} = 6.5\text{V}$)	I_{in}	– –	0.33 0.52	1.0 1.4	μA
Maximum Operating Voltage (Pin 2)	$V_{in(max)}$	–	–	10	V

NCP300, NCP301

ELECTRICAL CHARACTERISTICS (continued) (For all values $T_A = -40^{\circ}\text{C}$ to $+125^{\circ}\text{C}$, unless otherwise noted.)

Characteristic	Symbol	Min	Typ	Max	Unit
NCP300/1 – 4.5 / NCV300/1 – 4.5					
Minimum Operating Voltage (Pin 2) ($T_A = 25^{\circ}\text{C}$) ($T_A = -40^{\circ}\text{C}$ to 125°C)	$V_{in(min)}$	– –	0.55 0.65	0.70 0.80	V
Reset Output Current (Pin 1, Active Low 'L' Suffix Devices) N-Channel Sink Current, NCP300, NCP301 ($V_{OUT} = 0.05\text{V}$, $V_{in} = 0.70\text{V}$) ($V_{OUT} = 0.50\text{V}$, $V_{in} = 1.5\text{V}$) P-Channel Source Current, NCP300 ($V_{OUT} = 5.9\text{V}$, $V_{in} = 8.0\text{V}$)	I_{OUT}	0.01 1.0 1.5	0.05 2.0 10.5	– – –	mA
Reset Output Current (Pin 1, Active High 'H' Suffix Devices) N-Channel Sink Current, NCP300, NCP301 ($V_{OUT} = 0.5\text{ V}$, $V_{in} = 5.0\text{ V}$) P-Channel Source Current, NCP300 ($V_{OUT} = 0.4\text{ V}$, $V_{in} = 0.7\text{ V}$) ($V_{OUT} = \text{GND}$, $V_{in} = 1.5\text{ V}$)	I_{OUT}	6.3 0.011 0.525	11 0.04 0.6	– – –	mA
Propagation Delay Input to Output (Figure 2) Complementary Output NCP300 Series Output Transition, High to Low Output Transition, Low to High N-Channel Open Drain NCP301 Series Output Transition, High to Low Output Transition, Low to High	t_{pHL} t_{pLH} t_{pHL} t_{pLH}	– – – –	49 130 49 –	– 300 – 300	μs
NCP300/1 – 4.7 / NCV300/1 – 4.7					
Detector Threshold (Pin 2, V_{in} Decreasing) ($T_A = 25^{\circ}\text{C}$) ($T_A = -40^{\circ}\text{C}$ to 125°C)	V_{DET-}	4.606 4.559	4.700 –	4.794 4.841	V
Detector Threshold Hysteresis (Pin 2, V_{in} Increasing)	V_{HYS}	0.141	0.235	0.329	V
Supply Current (Pin 2) ($V_{in} = 4.54\text{ V}$) ($V_{in} = 6.7\text{ V}$)	I_{in}	– –	0.34 0.53	1.0 1.4	μA
Maximum Operating Voltage (Pin 2)	$V_{in(max)}$	–	–	10	V
Minimum Operating Voltage (Pin 2) ($T_A = 25^{\circ}\text{C}$) ($T_A = -40^{\circ}\text{C}$ to 125°C)	$V_{in(min)}$	– –	0.55 0.65	0.70 0.80	V
Reset Output Current (Pin 1, Active Low 'L' Suffix Devices) N-Channel Sink Current, NCP300, NCP301 ($V_{OUT} = 0.05\text{V}$, $V_{in} = 0.70\text{V}$) ($V_{OUT} = 0.50\text{V}$, $V_{in} = 1.5\text{V}$) P-Channel Source Current, NCP300 ($V_{OUT} = 5.9\text{V}$, $V_{in} = 8.0\text{V}$)	I_{OUT}	0.01 1.0 1.5	0.05 2.0 10.5	– – –	mA
Reset Output Current (Pin 1, Active High 'H' Suffix Devices) N-Channel Sink Current, NCP300, NCP301 ($V_{OUT} = 0.5\text{ V}$, $V_{in} = 5.0\text{ V}$) P-Channel Source Current, NCP300 ($V_{OUT} = 0.4\text{ V}$, $V_{in} = 0.7\text{ V}$) ($V_{OUT} = \text{GND}$, $V_{in} = 1.5\text{ V}$)	I_{OUT}	6.3 0.011 0.525	11 0.04 0.6	– – –	mA
Propagation Delay Input to Output (Figure 2) Complementary Output NCP300 Series Output Transition, High to Low Output Transition, Low to High N-Channel Open Drain NCP301 Series Output Transition, High to Low Output Transition, Low to High	t_{pHL} t_{pLH} t_{pHL} t_{pLH}	– – – –	45 130 45 –	– 300 – 300	μs

Product parametric performance is indicated in the Electrical Characteristics for the listed test conditions, unless otherwise noted. Product performance may not be indicated by the Electrical Characteristics if operated under different conditions.

NCP300, NCP301



NCP300 and NCP301 series are measured with a 10 pF capacitive load. NCP301 has an additional 470 k pull-up resistor connected from the reset output to +5.0 V. The reset output voltage waveforms are shown for the active low 'L' devices. The upper detector threshold, V_{DET+} is the sum of the lower detector threshold, V_{DET-} plus the input hysteresis, V_{HYS} .

Figure 2. Propagation Delay Measurement Conditions

NCP300, NCP301

Table 1. ELECTRICAL CHARACTERISTIC TABLE FOR 0.9 – 4.9 V

NCP300 Series	Detector Threshold			Detector Threshold Hysteresis			Supply Current		Nch Sink Current		Pch Source Current
							V _{in} Low	V _{in} High	V _{in} Low	V _{in} High	
Part Number	V _{DET-} (V) (Note 4)			V _{HYS} (V)			I _{in} (μA) (Note 5)	I _{in} (μA) (Note 6)	I _{OUT} (mA) (Note 7)	I _{OUT} (mA) (Note 8)	I _{OUT} (mA) (Note 9)
	Min	Typ	Max	Min	Typ	Max	Typ	Typ	Typ	Typ	Typ
NCP300LSN09T1	0.882	0.9	0.918	0.027	0.045	0.063	0.20	0.45	0.05	0.5	2.0
NCP300LSN18T1	1.764	1.8	1.836	0.054	0.090	0.126	0.23	0.48			
NCP300LSN185T1	1.813	1.85	1.887	0.056	0.093	0.130					
NCP300LSN20T1	1.960	2.0	2.040	0.060	0.100	0.140					
NCP300LSN25T1	2.45	2.5	2.55	0.075	0.125	0.175	0.25	0.50	0.33	0.52	0.34
NCP300LSN27T1	2.646	2.7	2.754	0.081	0.135	0.189	0.25	0.50			
NCP300LSN28T1	2.744	2.8	2.856	0.084	0.140	0.196					
NCP300LSN30T1	2.940	3.0	3.060	0.090	0.150	0.210					
NCP300LSN33T1	3.234	3.3	3.366	0.099	0.165	0.231					
NCP300LSN34T1	3.332	3.4	3.468	0.102	0.170	0.238					
NCP300LSN44T1	4.312	4.4	4.488	0.132	0.220	0.308					
NCP300LSN45T1	4.410	4.5	4.590	0.135	0.225	0.315					
NCP300LSN46T1	4.508	4.6	4.692	0.138	0.230	0.322					
NCP300LSN47T1	4.606	4.7	4.794	0.141	0.235	0.329					

4. Values shown apply at +25°C only. For voltage options greater than 1.1 V, V_{DET-} limits over operating temperature range (-40°C to +125°C) are V_{NOM} ±3%. For voltage options < 1.2 V, V_{DET-} is guaranteed only at +25°C.
5. Condition 1: 0.9 – 2.9 V, V_{in} = V_{DET-} - 0.10 V; 3.0 – 3.9 V, V_{in} = V_{DET-} - 0.13 V; 4.0 – 4.9 V, V_{in} = V_{DET-} - 0.16 V
6. Condition 2: 0.9 – 4.9 V, V_{in} = V_{DET-} + 2.0 V
7. Condition 3: 0.9 – 4.9 V, V_{in} = 0.7 V, V_{OUT} = 0.05 V, Active Low 'L' Suffix Devices
8. Condition 4: 0.9 – 1.0 V, V_{in} = 0.85 V, V_{OUT} = 0.5 V; 1.1 – 1.5 V, V_{in} = 1.0 V, V_{OUT} = 0.5 V; 1.6 – 4.9 V, V_{in} = 1.5 V, V_{OUT} = 0.5 V, Active Low 'L' Suffix Devices
9. Condition 5: 0.9 – 3.9 V, V_{in} = 4.5 V, V_{OUT} = 2.4 V; 4.0 – 4.9 V, V_{in} = 8.0 V, V_{OUT} = 5.9 V, Active Low 'L' Suffix Devices

Table 2. ELECTRICAL CHARACTERISTIC TABLE FOR 0.9 – 4.9 V

NCP300 Series	Detector Threshold			Detector Threshold Hysteresis			Supply Current		Nch Sink Current	Pch Source Current	
							V _{in} Low	V _{in} High		V _{in} Low	V _{in} High
Part Number	V _{DET-} (V) (Note 10)			V _{HYS} (V)			I _{in} (μA) (Note 11)	I _{in} (μA) (Note 12)	I _{OUT} (mA) (Note 13)	I _{OUT} (mA) (Note 14)	I _{OUT} (mA) (Note 15)
	Min	Typ	Max	Min	Typ	Max	Typ	Typ	Typ	Typ	Typ
NCP300HSN09T1	0.882	0.9	0.918	0.027	0.045	0.063	0.20	0.45	2.5	0.04	0.08
NCP300HSN18T1	1.764	1.8	1.836	0.054	0.090	0.126	0.23	0.48			
NCP300HSN27T1	2.646	2.7	2.754	0.081	0.135	0.189	0.25	0.50			
NCP300HSN30T1	2.940	3.0	3.060	0.090	0.150	0.210					
NCP300HSN45T1	4.410	4.5	4.590	0.135	0.225	0.315	0.33	0.52			
NCP300HSN47T1	4.606	4.7	4.794	0.141	0.235	0.329	0.34	0.53			

10. Values shown apply at +25°C only. For voltage options greater than 1.1 V, V_{DET-} limits over operating temperature range (-40°C to +125°C) are V_{NOM} ±3%. For voltage options < 1.2 V, V_{DET-} is guaranteed only at +25°C.
11. Condition 1: 0.9 – 2.9 V, V_{in} = V_{DET-} - 0.10 V; 3.0 – 3.9 V, V_{in} = V_{DET-} - 0.13 V; 4.0 – 4.9 V, V_{in} = V_{DET-} - 0.16 V
12. Condition 2: 0.9 – 4.9 V, V_{in} = V_{DET-} + 2.0 V
13. Condition 3: 0.9 – 1.4 V, V_{in} = 1.5 V, V_{OUT} = 0.5 V; 1.5 – 4.9 V, V_{in} = 5.0 V, V_{OUT} = 0.5 V, Active High 'H' Suffix Devices
14. Condition 4: 0.9 – 4.9 V, V_{in} = 0.7 V, V_{OUT} = 0.4 V, Active High 'H' Suffix Devices
15. Condition 5: 0.9 – 1.0 V, V_{in} = 0.8 V, V_{OUT} = GND; 1.1 – 1.5 V, V_{in} = 1.0 V, V_{OUT} = GND; 1.6 – 4.9 V, V_{in} = 1.5 V, V_{OUT} = GND, Active High 'H' Suffix Devices

NCP300, NCP301

Table 3. ELECTRICAL CHARACTERISTIC TABLE FOR 0.9 – 4.9 V

NCP301 Series	Detector Threshold			Detector Threshold Hysteresis			Supply Current		Nch Sink Current					
							V _{in} Low	V _{in} High	V _{in} Low	V _{in} High				
	V _{DET-} (V) (Note 16)			V _{HYS} (V)			I _{in} (μA) (Note 16)	I _{in} (μA) (Note 18)	I _{OUT} (mA) (Note 19)	I _{OUT} (mA) (Note 20)				
Part Number	Min	Typ	Max	Min	Typ	Max	Typ	Typ	Typ	Typ				
NCP301LSN09T1	0.882	0.9	0.918	0.027	0.045	0.063	0.20	0.45	0.05	0.5				
NCP301LSN12T1	1.176	1.2	1.224	0.036	0.060	0.084								
NCP301LSN16T1	1.568	1.6	1.632	0.048	0.080	0.112								
NCP301LSN18T1	1.764	1.8	1.836	0.054	0.090	0.126	0.23	0.48		2.0				
NCP301LSN20T1	1.960	2.0	2.040	0.060	0.100	0.140								
NCP301LSN22T1	2.156	2.2	2.244	0.066	0.110	0.154								
NCP301LSN24T1	2.352	2.4	2.448	0.072	0.120	0.168								
NCP301LSN25T1	2.450	2.5	2.550	0.075	0.125	0.175								
NCP301LSN26T1	2.548	2.6	2.652	0.078	0.130	0.182								
NCP301LSN27T1	2.646	2.7	2.754	0.081	0.135	0.189								
NCP301LSN28T1	2.744	2.8	2.856	0.084	0.140	0.196								
NCP301LSN30T1	2.940	3.0	3.060	0.090	0.150	0.210								
NCP301LSN31T1	3.038	3.1	3.162	0.093	0.155	0.217								
NCP301LSN32T1	3.136	3.2	3.264	0.096	0.160	0.224	0.25	0.50						
NCP301LSN33T1	3.234	3.3	3.366	0.099	0.165	0.231								
NCP301LSN34T1	3.332	3.4	3.468	0.102	0.170	0.238								
NCP301LSN36T1	3.528	3.6	3.672	0.108	0.180	0.252								
NCP301LSN40T1	3.920	4.0	4.080	0.120	0.200	0.280								
NCP301LSN42T1	4.116	4.2	4.284	0.126	0.210	0.294								
NCP301LSN45T1	4.410	4.5	4.590	0.135	0.225	0.315								
NCP301LSN46T1	4.508	4.6	4.692	0.138	0.230	0.322					0.33	0.52		
NCP301LSN47T1	4.606	4.7	4.794	0.141	0.235	0.329								
											0.34	0.53		

16. Values shown apply at +25°C only. For voltage options greater than 1.1 V, V_{DET-} limits over operating temperature range (-40°C to +125°C) are V_{NOM} ±3%. For voltage options < 1.2 V, V_{DET-} is guaranteed only at +25°C.

17. Condition 1: 0.9 – 2.9 V, V_{in} = V_{DET-} – 0.10 V; 3.0 – 3.9 V, V_{in} = V_{DET-} – 0.13 V; 4.0 – 4.9 V, V_{in} = V_{DET-} – 0.16 V

18. Condition 2: 0.9 – 4.9 V, V_{in} = V_{DET-} + 2.0 V

19. Condition 3: 0.9 – 4.9 V, V_{in} = 0.7 V, V_{OUT} = 0.05 V, Active Low 'L' Suffix Devices

20. Condition 4: 0.9 – 1.0 V, V_{in} = 0.85 V, V_{OUT} = 0.5 V; 1.1 – 1.5 V, V_{in} = 1.0 V, V_{OUT} = 0.5 V; 1.6 – 4.9 V, V_{in} = 1.5 V, V_{OUT} = 0.5 V, Active Low 'L' Suffix Devices

Table 4. ELECTRICAL CHARACTERISTIC TABLE FOR 0.9 – 4.9 V

NCP301 Series	Detector Threshold			Detector Threshold Hysteresis			Supply Current		Nch Sink Current
							V _{in} Low	V _{in} High	
	V _{DET-} (V) (Note 21)			V _{HYS} (V)			I _{in} (μA) (Note 22)	I _{in} (μA) (Note 23)	I _{OUT} (mA) (Note 24)
Part Number	Min	Typ	Max	Min	Typ	Max	Typ	Typ	Typ
NCP301HSN09T1	0.882	0.9	0.918	0.027	0.045	0.063	0.20	0.45	2.5
NCP301HSN18T1	1.764	1.8	1.836	0.054	0.090	0.126			
NCP301HSN22T1	2.156	2.2	2.244	0.066	0.110	0.154			
NCP301HSN27T1	2.646	2.7	2.754	0.081	0.135	0.189	0.25	0.50	
NCP301HSN30T1	2.940	3.0	3.060	0.090	0.150	0.210			
NCP301HSN45T1	4.410	4.5	4.590	0.135	0.225	0.315			
							0.33	0.52	

21. Values shown apply at +25°C only. For voltage options greater than 1.1 V, V_{DET-} limits over operating temperature range (-40°C to +125°C) are V_{NOM} ±3%. For voltage options < 1.2 V, V_{DET-} is guaranteed only at +25°C.

22. Condition 1: 0.9 – 2.9 V, V_{in} = V_{DET-} – 0.10 V; 3.0 – 3.9 V, V_{in} = V_{DET-} – 0.13 V; 4.0 – 4.9 V, V_{in} = V_{DET-} – 0.16 V

23. Condition 2: 0.9 – 4.9 V, V_{in} = V_{DET-} + 2.0 V

24. Condition 3: 0.9 – 1.4 V, V_{in} = 1.5 V, V_{OUT} = 0.5 V; 1.5 – 4.9 V, V_{in} = 5.0 V, V_{OUT} = 0.5 V, Active High 'H' Suffix Devices

NCP300, NCP301

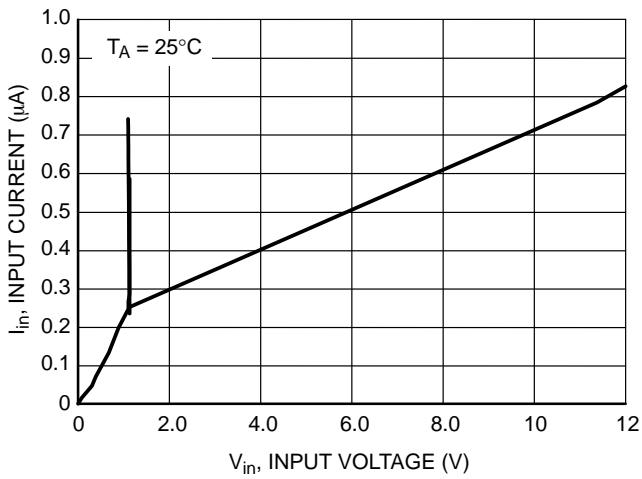

Figure 3. NCP300/1 Series 0.9 V Input Current versus Input Voltage

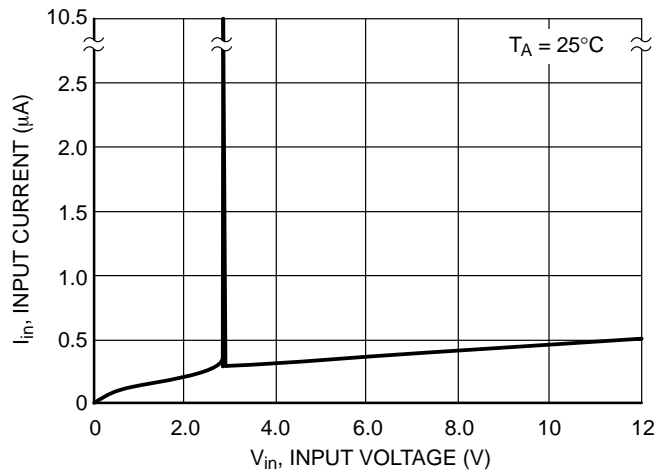

Figure 4. NCP300/1 Series 2.7 V Input Current versus Input Voltage

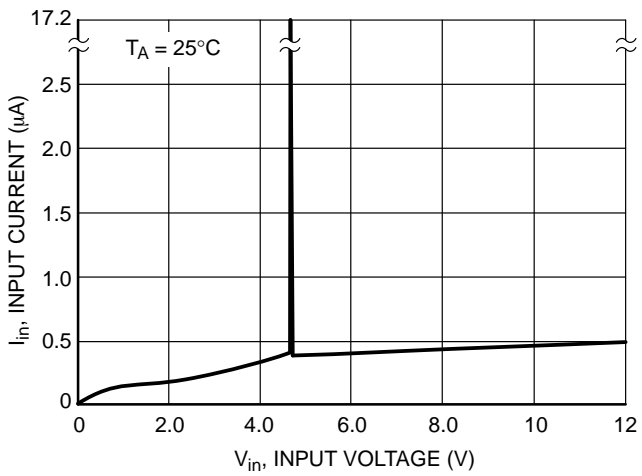

Figure 5. NCP300/1 Series 4.5 V Input Current versus Input Voltage

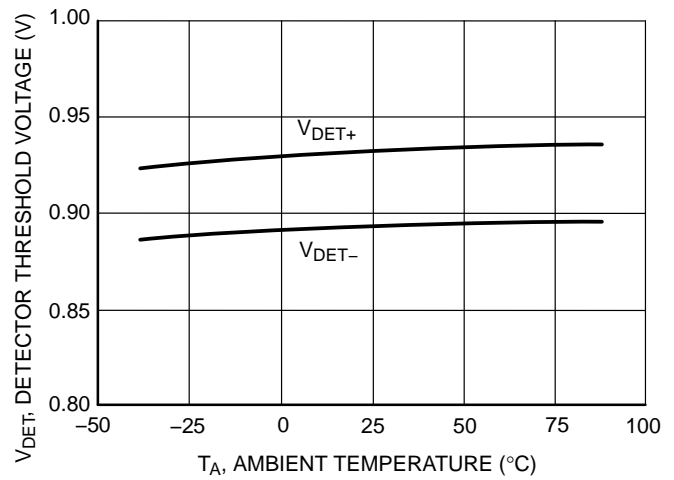

Figure 6. NCP300/1 Series 0.9 V Detector Threshold Voltage versus Temperature



Figure 7. NCP300/1 Series 2.7 V Detector Threshold Voltage versus Temperature

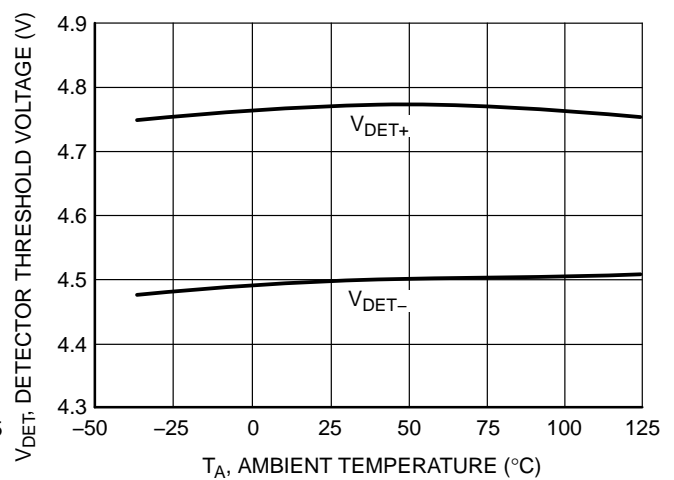

Figure 8. NCP300/1 Series 4.5 V Detector Threshold Voltage versus Temperature

NCP300, NCP301



Figure 9. NCP300L/1L Series 0.9 V Reset Output Voltage versus Input Voltage



Figure 10. NCP300L/1L Series 2.7 V Reset Output Voltage versus Input Voltage



Figure 11. NCP300L/1L Series 4.5 V Reset Output Voltage versus Input Voltage



Figure 12. NCP300H/1L Series 0.9 V Reset Output Sink Current versus Input Voltage



Figure 13. NCP300H/1L Series 2.7 V Reset Output Sink Current versus Input Voltage



Figure 14. NCP300H/1L Series 4.5 V Reset Output Sink Current versus Input Voltage

NCP300, NCP301



Figure 15. NCP300L Series 0.9 V
Reset Output Source Current versus Input Voltage



Figure 16. NCP300L Series 2.7 V
Reset Output Source Current versus Input Voltage



Figure 17. NCP300L Series 4.5 V
Reset Output Source Current versus Input Voltage



Figure 18. NCP300H/1L Series 0.9 V
Reset Output Sink Current versus Output Voltage



Figure 19. NCP300H/1L Series 2.7 V
Reset Output Sink Current versus Output Voltage



Figure 20. NCP300H/1L Series 4.5 V
Reset Output Sink Current versus Output Voltage

NCP300, NCP301

OPERATING DESCRIPTION

The NCP300 and NCP301 series devices are second generation ultra-low current voltage detectors. Figures 20 and 21 show a timing diagram and a typical application. Initially consider that input voltage V_{in} is at a nominal level and it is greater than the voltage detector upper threshold (V_{DET+}), and the reset output (Pin 1) will be in the high state for active low devices, or in the low state for active high devices. If there is a power interruption and V_{in} becomes significantly deficient, it will fall below the lower detector threshold (V_{DET-}). This sequence of events causes the Reset output to be in the low state for active low devices, or in the

high state for active high devices. After completion of the power interruption, V_{in} will again return to its nominal level and become greater than the V_{DET+} . The voltage detector has built-in hysteresis to prevent erratic reset operation as the comparator threshold is crossed.

Although these device series are specifically designed for use as reset controllers in portable microprocessor based systems, they offer a cost-effective solution in numerous applications where precise voltage monitoring is required. Figure 26 through Figure 33 shows various application examples.

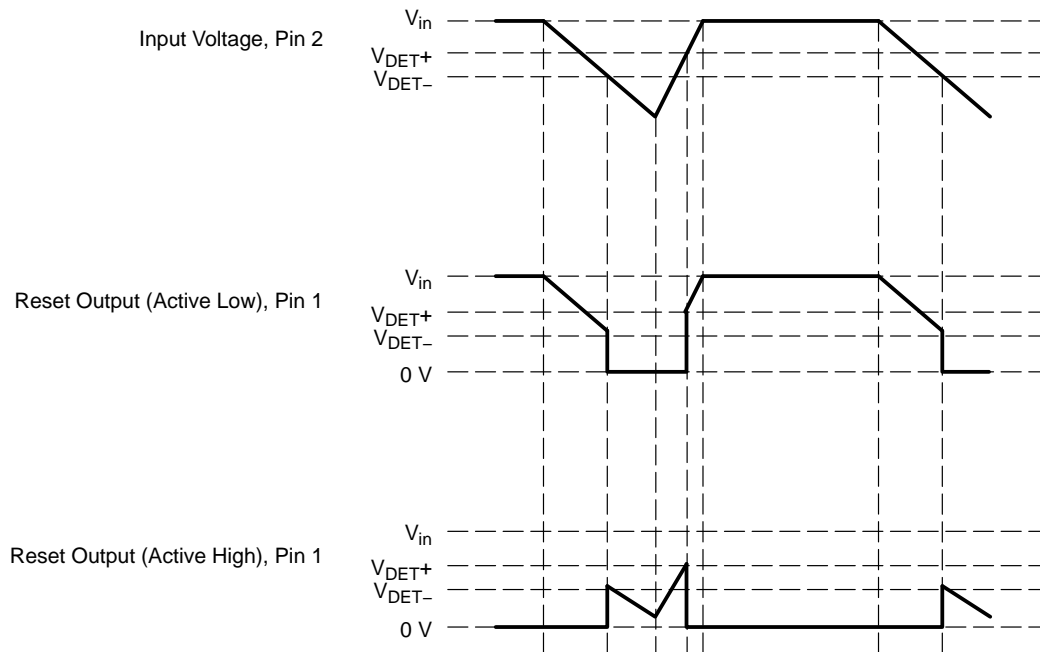

Figure 21. Timing Waveforms

V_{CC} TRANSIENT REJECTION

The NCP300 and NCP301 series provides accurate V_{CC} monitoring and reset timing during power-up, power-down, and brownout/sag conditions, and rejects negative glitches on the power supply line. Figure 22 shows the maximum transient duration vs. maximum negative excursion (overdrive) for glitch rejection. Any combination of duration and overdrive which lies under the curve will not generate a reset signal. A below-V_{CC} condition (on the right) is detected as a brownout or power-down. Typically, any transient that goes 100 mV below the reset threshold and lasts 5.0 μs or less will not cause a reset pulse.

Transient immunity can be improved by adding a capacitor in close proximity to the V_{CC} pin of the NCP30x.



Figure 22. Max Transient Duration vs. Max Overdrive

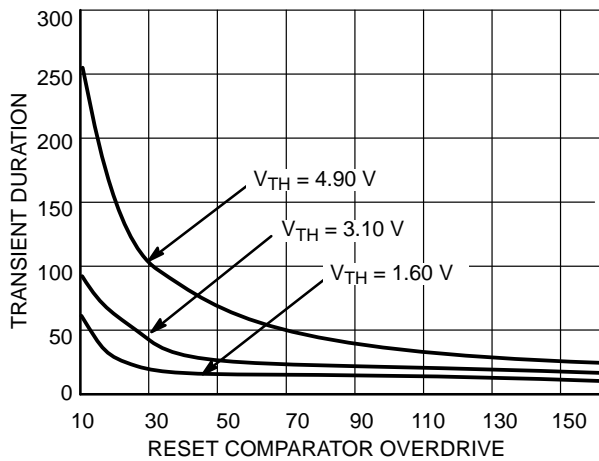

Figure 23.

FACTORS TO BE CONSIDERED FOR VOLTAGE OPTION SELECTION

The following hysteresis graph depicts V_{DET-_{min}/max} and V_{DET+_{min}/max} for an active low Reset device:

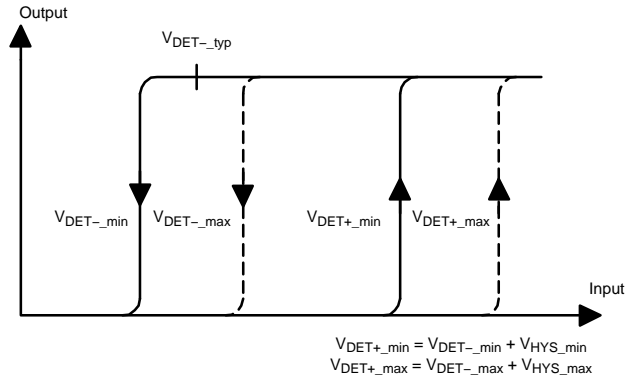

Figure 24.

For selecting a voltage option in the NCP30X family, three major factors should be considered:

1. V_{DET+_{max}}: Maximum detector threshold voltage for increasing V_{in} for the NCP30X device.
2. V_{in_min}: Minimum voltage output of the power supply. This is also the input voltage to the NCP30X device.
3. V_{CC_min}: Minimum power supply voltage specification for the device that is protected by the NCP30X.

The V_{DET+_{max}} for an NCP30X device is normally calculated as follows:

$$V_{DET+_{max}} = V_{DET-_{max}} + V_{HYS_{max}} \quad (\text{eq. 1})$$

Where:

V_{DET-_{max}} = Maximum detector threshold voltage for decreasing V_{in}

V_{HYS_{max}} = Maximum detector threshold hysteresis

The above two parameters can be obtained directly from the data sheet to figure out the V_{DET+_{max}}.

In the NCP30X family, for a given V_{DET-_{typ}}, which is the typical detection voltage reflected in the part number, the threshold values are designed to the following targets (at 25°C):

$$V_{DET-_{min}} = V_{DET-_{typ}} - 2\% \quad (\text{eq. 2})$$

$$V_{DET-_{max}} = V_{DET-_{typ}} + 2\% \quad (\text{eq. 3})$$

$$V_{HYS_{typ}} = 5\% \text{ of } V_{DET-_{typ}} \quad (\text{eq. 4})$$

$$V_{HYS_{min}} = V_{HYS_{typ}} - 40\% \quad (\text{eq. 5})$$

$$V_{HYS_{max}} = V_{HYS_{typ}} + 40\% \quad (\text{eq. 6})$$

By simple mathematical calculation, combining Equations 2 to 6, Equation 1 becomes:

$$V_{DET+_{max}} = V_{DET-_{typ}} \times 1.09 \quad (\text{eq. 7})$$

NCP300, NCP301

So, $V_{DET+_{max}}$ can be easily figured out just using a single variable $V_{DET-_{typ}}$.

For example, for NCP300LSN18T1G $V_{DET-_{typ}} = 1.8\text{ V}$; then

$$V_{DET+_{max}} = 1.8 \times 1.09 = 1.962\text{ V} \quad (\text{eq. 8})$$

The NCP30X detection voltage option must be chosen such that:

$$V_{CC_{min}} < V_{DET+_{max}} < V_{in_{min}} \quad (\text{eq. 9})$$

The significance of $V_{CC_{min}} < V_{DET+_{max}}$ is that it makes sure the the reset from NCP30X remains asserted (in RESET hold state) till after the power supply exceeds the $V_{CC_{min}}$ requirement; this prevents incorrect device (uP) initiation.

Having $V_{DET+_{max}} < V_{in_{min}}$ makes sure that the NCP30X is able to start up when V_{in} is at the $V_{in_{min}}$.

The theoretical ideal $V_{DET-_{typ}}$ voltage option to be selected by the user, $V_{DET-_{typ_{ideal}}}$, can be given by the following formula:

$$V_{DET-_{typ_{ideal}}} = \frac{(V_{in_{min}} + V_{CC_{min}})}{(2 \times 1.09)} \quad (\text{eq. 10})$$

The following example shows how to select the device voltage option in a real world application.

1. Power supply output specification: $3.3\text{ V} \pm 3\%$
2. Microprocessor core voltage specification: $3.3\text{ V} \pm 5\%$

So, we have:

$$V_{in_{min}} = 3.3\text{ V} - 3\% = 3.201\text{ V} \quad (\text{eq. 11})$$

$$V_{CC_{min}} = 3.3\text{ V} - 5\% = 3.135\text{ V} \quad (\text{eq. 12})$$

Then the ideal voltage option = $(3.201 + 3.135) / (2 * 1.09) = 2.9064\text{ V}$

Therefore, a device voltage option of 2.9 V will be the right choice.

PROPAGATION DELAY VARIATION

On the other hand (see above paragraph), a minimum overdrive value from $V_{threshold}$ to V_{CC} must be respected. That means V_{in} (minimum value of V_{CC}) must be higher enough than V_{DET+} ($V_{DET-} + \text{hysteresis}$) at the risk of significantly increasing propagation delay. (Figure 25) This propagation delay is temperature sensitive.

To avoid acceptable time response, a minimum 100 mV difference between V_{in} and V_{DET+} must be selected.



Figure 25. t_{pLH} and t_{pHL} vs. Input Voltage for the NCP301SNT1

NCP300, NCP301

APPLICATION CIRCUIT INFORMATION



Figure 26. Microprocessor Reset Circuit



Figure 27. Battery Charge Indicator



Figure 28. Window Voltage Detector

NCP300, NCP301

APPLICATION CIRCUIT INFORMATION



Figure 29. Dual Power Supply Undervoltage Supervision



Figure 30. Microprocessor Reset Circuit with Additional Hysteresis

Comparator hysteresis can be increased with the addition of resistor R_H . The hysteresis equations have been simplified and do not account for the change of input current I_{in} as V_{in} crosses the comparator threshold. The internal resistance, R_{in} is simply calculated using $I_{in} = 0.26 \mu A$ at 2.6 V.

V_{in} Decreasing:

$$V_{th} = \left(\frac{R_H}{R_{in}} + 1 \right) (V_{DET-})$$

V_{in} Increasing:

$$V_{th} = \left(\frac{R_H}{R_{in} \parallel R_L} + 1 \right) (V_{DET-} + V_{HYS})$$

$$V_{HYS} = V_{in \text{ Increasing}} - V_{in \text{ Decreasing}}$$

Test Data				
V_{th} Decreasing (V)	V_{th} Increasing (V)	V_{HYS} (V)	R_H (Ω)	R_L (k Ω)
2.70	2.84	0.135	0	-
2.70	2.87	0.17	100	10
2.70	2.88	0.18	100	6.8
2.70	2.91	0.21	100	4.3
2.70	2.90	0.20	220	10
2.70	2.94	0.24	220	6.8
2.70	2.98	0.28	220	4.3
2.70	2.97	0.27	470	10
2.70	3.04	0.34	470	6.8
2.70	3.15	0.45	470	4.3

NCP300, NCP301



Test Data				
	R2 = 82 kΩ		R2 = 8.2 kΩ	
C (nF)	f _{OSC} (kHz)	I _Q (μA)	f _{OSC} (kHz)	I _Q (μA)
0.01	10.4	18	6.0	30
0.068	9.8	18	5.7	30
1.0	6.18	21	3.6	29
10	1.41	21	1.34	25
100	0.27	22	0.356	23
1000	0.045	22	0.077	22

Table values are for information only.

Figure 31. Simple Clock Oscillator



This circuit monitors the current at the load. As current flows through the load, a voltage drop with respect to ground appears across R_{sense} where $V_{sense} = I_{load} * R_{sense}$. The following conditions apply:

If: $I_{Load} < V_{DET-} / R_{sense}$ $I_{Load} \geq (V_{DET-} + V_{HYS}) / R_{sense}$	Then: Reset Output = 0 V Reset Output = V_{DD}
--	--

Figure 32. Microcontroller System Load Sensing

NCP300, NCP301



A simple voltage monitor can be constructed by connecting several voltage detectors as shown above. Each LED will sequentially turn on when the respective voltage detector threshold ($V_{DET-} + V_{HYS}$) is exceeded. Note that detector thresholds (V_{DET-}) that range from 0.9 V to 4.9 V in 100 mV steps can be manufactured.

Figure 33. LED Bar Graph Voltage Monitor

NCP300, NCP301

ORDERING INFORMATION

Device	Threshold Voltage	Output Type	Reset	Marking	Package	Shipping [†]
NCP300LSN09T1G	0.9	CMOS	Active Low	SEJ	TSOP-5 (Pb-Free)	3000 / Tape & Reel (7 in. Reel)
NCP300LSN18T1G	1.8			SFK	TSOP-5 (Pb-Free)	
NCP300LSN185T1G	1.85			SRA	TSOP-5 (Pb-Free)	
NCP300LSN20T1G	2.0			SHE	TSOP-5 (Pb-Free)	
NCV300LSN20T1G*				SIM		
NCP300LSN25T1G	2.5			RUM	TSOP-5 (Pb-Free)	
NCP300LSN27T1G	2.7			SEE	TSOP-5 (Pb-Free)	
NCV300LSN27T1G*				SIW		
NCP300LSN28T1G	2.8			SED	TSOP-5 (Pb-Free)	
NCV300LSN28T1G*				SSL		
NCP300LSN30T1G	3.0			SEC	TSOP-5 (Pb-Free)	
NCV300LSN30T1G*				SQV		
NCP300LSN33T1G	3.3			SKV	TSOP-5 (Pb-Free)	
NCP300LSN34T1G	3.4			SKU	TSOP-5 (Pb-Free)	
NCV300LSN36T1G*	3.6			SKS		
NCP300LSN44T1G	4.4			SKK	TSOP-5 (Pb-Free)	
NCP300LSN45T1G	4.5			SEA	TSOP-5 (Pb-Free)	
NCP300LSN46T1G	4.6			SKJ	TSOP-5 (Pb-Free)	
NCP300LSN47T1G	4.7	SDZ	TSOP-5 (Pb-Free)			
NCP300HSN09T1G	0.9	CMOS	Active High	SDY	TSOP-5 (Pb-Free)	3000 / Tape & Reel (7 in. Reel)
NCP300HSN18T1G	1.8			SFJ	TSOP-5 (Pb-Free)	
NCP300HSN27T1G	2.7			SDU	TSOP-5 (Pb-Free)	
NCP300HSN30T1G	3.0			SDS	TSOP-5 (Pb-Free)	
NCP300HSN45T1G	4.5			SDQ	TSOP-5 (Pb-Free)	
NCP300HSN47T1G	4.7			SDP	TSOP-5 (Pb-Free)	

NOTE: The ordering information lists standard undervoltage thresholds with active low outputs. Additional active low threshold devices, ranging from 0.9 V to 4.9 V in 100 mV increments and NCP300/NCP301 active high output devices, ranging from 0.9 V to 4.9 V in 100 mV increments can be manufactured. Contact your ON Semiconductor representative for availability. The electrical characteristics of these additional devices are shown in Tables 1 through 4.

[†]For information on tape and reel specifications, including part orientation and tape sizes, please refer to our Tape and Reel Packaging Specifications Brochure, BRD8011/D.

*NCV prefix for Automotive and Other Applications Requiring Unique Site and Control Change Requirements; AEC-Q100 Qualified and PPAP Capable.

NCVxxx: T_{low} = -40°C, T_{high} = +125°C. Guaranteed by design.

NCP300, NCP301

ORDERING INFORMATION

Device	Threshold Voltage	Output Type	Reset	Marking	Package	Shipping†
NCP301LSN09T1G	0.9	Open Drain	Active Low	SFF	TSOP-5 (Pb-Free)	3000 / Tape & Reel (7 in. Reel)
NCP301LSN12T1G	1.2			SNN	TSOP-5 (Pb-Free)	
NCV301LSN12T1*	1.2			SRK	TSOP-5	
NCV301LSN12T1G*					TSOP-5 (Pb-Free)	
NCP301LSN16T1G	1.6			SNJ	TSOP-5 (Pb-Free)	
NCV301LSN16T1*	1.6			SRL	TSOP-5	
NCV301LSN16T1G*					TSOP-5 (Pb-Free)	
NCP301LSN18T1G	1.8			SFN	TSOP-5 (Pb-Free)	
NCP301LSN18T2G	1.8			DT2	TSOP-5 (Pb-Free)	
NCP301LSN20T1G					2.0	
NCV301LSN20T1G*	2.0			SRM	TSOP-5 (Pb-Free)	
NCP301LSN22T1G					2.2	
NCV301LSN22T1*	2.2			SUA	TSOP-5	
NCV301LSN22T1G*					TSOP-5 (Pb-Free)	
NCP301LSN24T1G	2.4			TAN	TSOP-5 (Pb-Free)	
NCP301LSN25T1G	2.5			SNF	TSOP-5 (Pb-Free)	
NCP301LSN25T2G	2.5			ET2	TSOP-5 (Pb-Free)	
NCV301LSN25T1G*					SRN	
NCP301LSN26T1G	2.6			SNE	TSOP-5 (Pb-Free)	
NCP301LSN27T1G	2.7			SFA	TSOP-5 (Pb-Free)	
NCP301LSN27T2G	2.7			FT2	TSOP-5 (Pb-Free)	
NCP301LSN28T1G					2.8	
NCV301LSN28T1G*	2.8			SRO	TSOP-5 (Pb-Free)	
NCP301LSN30T1G					3.0	
NCP301LSN30T2G	3.0			GT2	TSOP-5 (Pb-Free)	
NCV301LSN30T1G*					AJA	
NCP301LSN31T1G	3.1			SEW	TSOP-5 (Pb-Free)	
NCP301LSN32T1G	3.2			SNC	TSOP-5 (Pb-Free)	

NOTE: The ordering information lists standard undervoltage thresholds with active low outputs. Additional active low threshold devices, ranging from 0.9 V to 4.9 V in 100 mV increments and NCP300/NCP301 active high output devices, ranging from 0.9 V to 4.9 V in 100 mV increments can be manufactured. Contact your ON Semiconductor representative for availability. The electrical characteristics of these additional devices are shown in Tables 1 through 4.

†For information on tape and reel specifications, including part orientation and tape sizes, please refer to our Tape and Reel Packaging Specifications Brochure, BRD8011/D.

*NCV prefix for Automotive and Other Applications Requiring Unique Site and Control Change Requirements; AEC-Q100 Qualified and PPAP Capable.

NCVxxx: T_{low} = -40°C, T_{high} = +125°C. Guaranteed by design.

NCP300, NCP301

ORDERING INFORMATION

Device	Threshold Voltage	Output Type	Reset	Marking	Package	Shipping†
NCP301LSN33T1G	3.3	Open Drain	Active Low	SNB	TSOP-5 (Pb-Free)	3000 / Tape & Reel (7 in. Reel)
NCV301LSN33T1G*				ACG	TSOP-5 (Pb-Free)	
NCP301LSN34T1G	3.4			SNA	TSOP-5 (Pb-Free)	
NCP301LSN36T1G				SMY		
NCP301LSN39T1G				SNA		
NCP301LSN40T1G	4.0			SMU	TSOP-5 (Pb-Free)	
NCV301LSN40T1*				SRP	TSOP-5	
NCV301LSN40T1G*					TSOP-5 (Pb-Free)	
NCP301LSN42T1G	4.2			SMS	TSOP-5 (Pb-Free)	
NCV301LSN42T1G*				ACR		
NCP301LSN45T1G	4.5			SEV	TSOP-5 (Pb-Free)	
NCV301LSN45T1G*				SRQ		
NCP301LSN46T1G				SMP	TSOP-5 (Pb-Free)	
NCP301LSN47T1G	4.7			SEU	TSOP-5	
NCV301LSN47T1G*				SSJ	(Pb-Free)	

NOTE: The ordering information lists standard undervoltage thresholds with active low outputs. Additional active low threshold devices, ranging from 0.9 V to 4.9 V in 100 mV increments and NCP300/NCP301 active high output devices, ranging from 0.9 V to 4.9 V in 100 mV increments can be manufactured. Contact your ON Semiconductor representative for availability. The electrical characteristics of these additional devices are shown in Tables 1 through 4.

†For information on tape and reel specifications, including part orientation and tape sizes, please refer to our Tape and Reel Packaging Specifications Brochure, BRD8011/D.

*NCV prefix for Automotive and Other Applications Requiring Unique Site and Control Change Requirements; AEC-Q100 Qualified and PPAP Capable.

NCVxxx: $T_{low} = -40^{\circ}\text{C}$, $T_{high} = +125^{\circ}\text{C}$. Guaranteed by design.

NCP300, NCP301

ORDERING INFORMATION

Device	Threshold Voltage	Output Type	Reset	Marking	Package	Shipping†
NCP301HSN09T1G	0.9	Open Drain	Active High	SET	TSOP-5 (Pb-Free)	3000 / Tape & Reel (7 in. Reel)
NCP301HSN18T1G	1.8			SFM	TSOP-5 (Pb-Free)	
NCP301HSN22T1G	2.2			SMD	TSOP-5 (Pb-Free)	
NCP301HSN27T1G	2.7			SEP	TSOP-5 (Pb-Free)	
NCV301HSN27T1G*				SUD		
NCP301HSN30T1G	3.0			SEN	TSOP-5 (Pb-Free)	
NCP301HSN45T1G	4.5			SEL	TSOP-5 (Pb-Free)	

NOTE: The ordering information lists standard undervoltage thresholds with active low outputs. Additional active low threshold devices, ranging from 0.9 V to 4.9 V in 100 mV increments and NCP300/NCP301 active high output devices, ranging from 0.9 V to 4.9 V in 100 mV increments can be manufactured. Contact your ON Semiconductor representative for availability. The electrical characteristics of these additional devices are shown in Tables 1 through 4.

†For information on tape and reel specifications, including part orientation and tape sizes, please refer to our Tape and Reel Packaging Specifications Brochure, BRD8011/D.

*NCV prefix for Automotive and Other Applications Requiring Unique Site and Control Change Requirements; AEC-Q100 Qualified and PPAP Capable.

NCVxxx: $T_{low} = -40^{\circ}\text{C}$, $T_{high} = +125^{\circ}\text{C}$. Guaranteed by design.

MECHANICAL CASE OUTLINE PACKAGE DIMENSIONS

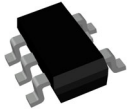

TSOP-5 3.00x1.50x0.95, 0.95P CASE 483 ISSUE P

DATE 01 APR 2024

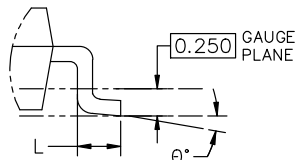

NOTES:

1. DIMENSIONING AND TOLERANCING CONFORM TO ASME Y14.5-2018.
2. ALL DIMENSION ARE IN MILLIMETERS (ANGLES IN DEGREES).
3. MAXIMUM LEAD THICKNESS INCLUDES LEAD FINISH THICKNESS. MINIMUM LEAD THICKNESS IS THE MINIMUM THICKNESS OF BASE MATERIAL.
4. DIMENSIONS D AND E1 DO NOT INCLUDE MOLD FLASH, PROTRUSIONS OF GATE BURRS. MOLD FLASH, PROTRUSIONS, OR GATE BURRS SHALL NOT EXCEED 0.15 PER SIDE. DIMENSION D.
5. OPTIONAL CONSTRUCTION: AN ADDITIONAL TRIMMED LEAD IS ALLOWED IN THIS LOCATION. TRIMMED LEAD NOT TO EXTEND MORE THAN 0.2 FROM BODY.

DIM	MILLIMETERS		
	MIN.	NOM.	MAX.
A	0.900	1.000	1.100
A1	0.010	0.055	0.100
A2	0.950 REF.		
b	0.250	0.375	0.500
c	0.100	0.180	0.260
D	2.850	3.000	3.150
E	2.500	2.750	3.000
E1	1.350	1.500	1.650
e	0.950 BSC		
L	0.200	0.400	0.600
θ	0°	5°	10°

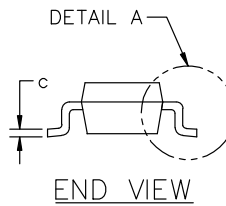

GENERIC MARKING DIAGRAM*

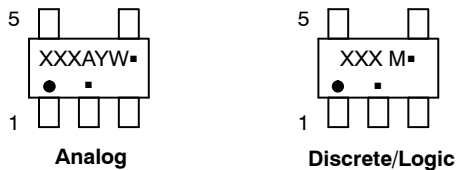

- XXX = Specific Device Code XXX = Specific Device Code
 A = Assembly Location M = Date Code
 Y = Year ▪ = Pb-Free Package
 W = Work Week

▪ = Pb-Free Package

(Note: Microdot may be in either location)

*This information is generic. Please refer to device data sheet for actual part marking. Pb-Free indicator, "G" or microdot "▪", may or may not be present. Some products may not follow the Generic Marking.

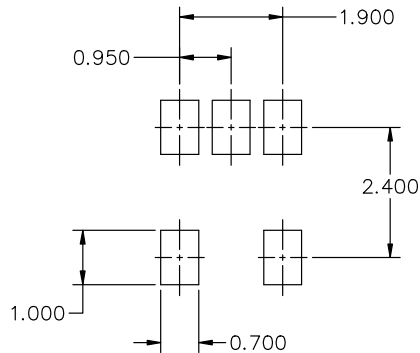

* FOR ADDITIONAL INFORMATION ON OUR Pb-FREE STRATEGY AND SOLDERING DETAILS, PLEASE DOWNLOAD THE ON SEMICONDUCTOR SOLDERING AND MOUNTING TECHNIQUES REFERENCE MANUAL, SOLDERM/D.

DOCUMENT NUMBER:	98ARB18753C	Electronic versions are uncontrolled except when accessed directly from the Document Repository. Printed versions are uncontrolled except when stamped "CONTROLLED COPY" in red.
DESCRIPTION:	TSOP-5 3.00x1.50x0.95, 0.95P	PAGE 1 OF 1

onsemi and ONSEMI are trademarks of Semiconductor Components Industries, LLC dba onsemi or its subsidiaries in the United States and/or other countries. onsemi reserves the right to make changes without further notice to any products herein. onsemi makes no warranty, representation or guarantee regarding the suitability of its products for any particular purpose, nor does onsemi assume any liability arising out of the application or use of any product or circuit, and specifically disclaims any and all liability, including without limitation special, consequential or incidental damages. onsemi does not convey any license under its patent rights nor the rights of others.

onsemi, **Onsemi**, and other names, marks, and brands are registered and/or common law trademarks of Semiconductor Components Industries, LLC dba "**onsemi**" or its affiliates and/or subsidiaries in the United States and/or other countries. **onsemi** owns the rights to a number of patents, trademarks, copyrights, trade secrets, and other intellectual property. A listing of **onsemi**'s product/patent coverage may be accessed at www.onsemi.com/site/pdf/Patent-Marking.pdf. **onsemi** reserves the right to make changes at any time to any products or information herein, without notice. The information herein is provided "as-is" and **onsemi** makes no warranty, representation or guarantee regarding the accuracy of the information, product features, availability, functionality, or suitability of its products for any particular purpose, nor does **onsemi** assume any liability arising out of the application or use of any product or circuit, and specifically disclaims any and all liability, including without limitation special, consequential or incidental damages. Buyer is responsible for its products and applications using **onsemi** products, including compliance with all laws, regulations and safety requirements or standards, regardless of any support or applications information provided by **onsemi**. "Typical" parameters which may be provided in **onsemi** data sheets and/or specifications can and do vary in different applications and actual performance may vary over time. All operating parameters, including "Typicals" must be validated for each customer application by customer's technical experts. **onsemi** does not convey any license under any of its intellectual property rights nor the rights of others. **onsemi** products are not designed, intended, or authorized for use as a critical component in life support systems or any FDA Class 3 medical devices or medical devices with a same or similar classification in a foreign jurisdiction or any devices intended for implantation in the human body. Should Buyer purchase or use **onsemi** products for any such unintended or unauthorized application, Buyer shall indemnify and hold **onsemi** and its officers, employees, subsidiaries, affiliates, and distributors harmless against all claims, costs, damages, and expenses, and reasonable attorney fees arising out of, directly or indirectly, any claim of personal injury or death associated with such unintended or unauthorized use, even if such claim alleges that **onsemi** was negligent regarding the design or manufacture of the part. **onsemi** is an Equal Opportunity/Affirmative Action Employer. This literature is subject to all applicable copyright laws and is not for resale in any manner.

ADDITIONAL INFORMATION

TECHNICAL PUBLICATIONS:

Technical Library: www.onsemi.com/design/resources/technical-documentation
onsemi Website: www.onsemi.com

ONLINE SUPPORT: www.onsemi.com/support

For additional information, please contact your local Sales Representative at www.onsemi.com/support/sales

Looking for pricing, stock, or lifecycle information?

Click below to explore more details on WIN SOURCE:

 [View NCP300LSN33T1 on WIN SOURCE](#)

 [ON Semiconductor Information](#)

Optimize Your Supply Chain with WIN SOURCE Solutions

-  Global Sourcing Solution
-  Obsolete Management
-  Cost Control Management
-  Shortage Management
-  Alternative Solution
-  Excess Inventory Management