



**THE DATASHEET OF
ADM7150ARDZ-3.3-R7**



FEATURES

Input voltage range: 4.5 V to 16 V

Maximum output current: 800 mA

Low noise

1.0 μV rms total integrated noise from 100 Hz to 100 kHz

1.6 μV rms total integrated noise from 10 Hz to 100 kHz

Noise spectral density: 1.7 nV/ $\sqrt{\text{Hz}}$ typical from 10 kHz to 1 MHz

Power supply rejection ratio (PSRR) at 400 mA load

>90 dB from 1 kHz to 100 kHz, $V_{\text{OUT}} = 5 \text{ V}$

>60 dB at 1 MHz, $V_{\text{OUT}} = 5 \text{ V}$

Dropout voltage: 0.6 V at $V_{\text{OUT}} = 5 \text{ V}$, 800 mA load

Initial voltage accuracy: $\pm 1\%$

Voltage accuracy over line, load and temperature: $\pm 2\%$

Quiescent current (I_{GND}): 4.3 mA at no load

Low shutdown current: 0.1 μA

Stable with a 10 μF ceramic output capacitor

Fixed output voltage options: 1.8 V, 2.8 V, 3.0 V, 3.3 V, 4.5 V, 4.8 V, and 5.0 V (16 outputs between 1.5 V and 5.0 V are available)

Exposed pad 8-lead LFCSP and 8-lead SOIC packages

APPLICATIONS

Regulated power noise sensitive applications

RF mixers, phase-locked loops (PLLs), voltage-controlled oscillators (VCOs), and PLLs with integrated VCOs

Communications and infrastructure

Cable digital-to-analog converter (DAC) drivers

Backhaul and microwave links

GENERAL DESCRIPTION

The **ADM7150** is a low dropout (LDO) linear regulator that operates from 4.5 V to 16 V and provides up to 800 mA of output current. Using an advanced proprietary architecture, it provides high power supply rejection (>90 dB from 1 kHz to 1 MHz), ultralow output noise (<1.7 nV/ $\sqrt{\text{Hz}}$), and achieves excellent line and load transient response with a 10 μF ceramic output capacitor.

The **ADM7150** is available in 1.8 V, 2.8 V, 3.0 V, 3.3 V, 4.5 V, 4.8 V, and 5.0 V fixed outputs. In addition, 16 fixed output voltages between 1.5 V and 5.0 V are available upon request.

The **ADM7150** regulator typical output noise is 1.0 μV rms from 100 Hz to 100 kHz for fixed output voltage options, and the noise spectral density is 1.7 nV/ $\sqrt{\text{Hz}}$ from 10 kHz to 1 MHz.

The **ADM7150** is available in 8-lead, 3 mm \times 3 mm LFCSP and 8-lead SOIC packages, making it not only a very compact solution but also providing excellent thermal performance for applications requiring up to 800 mA of output current in a small, low profile

TYPICAL APPLICATION CIRCUIT

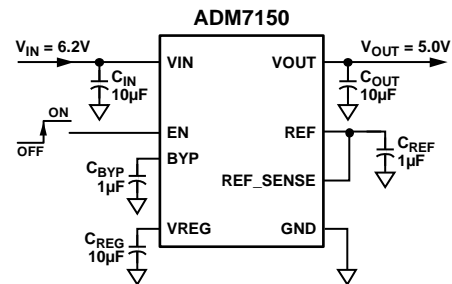

Figure 1. 5 V Output Circuit

11043-001

GENERAL DESCRIPTION

The **ADM7150** is a low dropout (LDO) linear regulator that operates from 4.5 V to 16 V and provides up to 800 mA of output current. Using an advanced proprietary architecture, it provides high power supply rejection (>90 dB from 1 kHz to 1 MHz), ultralow output noise (<1.7 nV/ $\sqrt{\text{Hz}}$), and achieves excellent line and load transient response with a 10 μF ceramic output capacitor.

The **ADM7150** is available in 1.8 V, 2.8 V, 3.0 V, 3.3 V, 4.5 V, 4.8 V, and 5.0 V fixed outputs. In addition, 16 fixed output voltages between 1.5 V and 5.0 V are available upon request.

The **ADM7150** regulator typical output noise is 1.0 μV rms from 100 Hz to 100 kHz for fixed output voltage options, and the noise spectral density is 1.7 nV/ $\sqrt{\text{Hz}}$ from 10 kHz to 1 MHz.

The **ADM7150** is available in 8-lead, 3 mm \times 3 mm LFCSP and 8-lead SOIC packages, making it not only a very compact solution but also providing excellent thermal performance for applications requiring up to 800 mA of output current in a small, low profile

footprint. See the **ADM7151** adjustable LDO to generate additional output voltages.

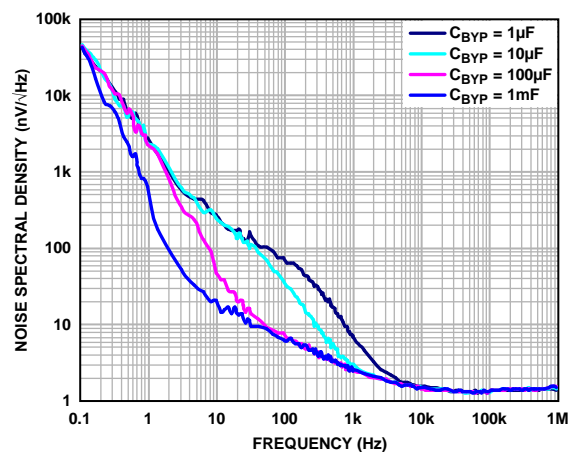

Figure 2. Noise Spectral Density (NSD) vs. Frequency for Various C_{BYP}

11043-002

Rev. 0

[Document Feedback](#)

Information furnished by Analog Devices is believed to be accurate and reliable. However, no responsibility is assumed by Analog Devices for its use, nor for any infringements of patents or other rights of third parties that may result from its use. Specifications subject to change without notice. No license is granted by implication or otherwise under any patent or patent rights of Analog Devices. Trademarks and registered trademarks are the property of their respective owners.

TABLE OF CONTENTS

Features	1	Typical Performance Characteristics	7
Applications.....	1	Theory of Operation	15
Typical Application Circuit	1	Applications Information	16
General Description	1	Capacitor Selection	16
Revision History	2	Enable (EN) and Undervoltage Lockout (UVLO).....	17
Specifications.....	3	Start-Up Time	18
Input and Output Capacitor Recommended Specifications...	4	REF, BYP, and, VREG pins.....	18
Absolute Maximum Ratings.....	5	Current-Limit and Thermal Overload Protection.....	19
Thermal Data	5	Thermal Considerations.....	19
Thermal Resistance	5	Printed Circuit Board Layout Considerations.....	21
ESD Caution.....	5	Outline Dimensions	22
Pin Configurations and Function Descriptions	6	Ordering Guide	22

REVISION HISTORY

9/13—Revision 0: Initial Version

SPECIFICATIONS

$V_{IN} = V_{OUT} + 1.2\text{ V}$ or $V_{IN} = 4.5\text{ V}$, whichever is greater, $V_{EN} = V_{IN}$, $I_{OUT} = 10\text{ mA}$, $C_{IN} = C_{OUT} = C_{REG} = 10\text{ }\mu\text{F}$, $C_{REF} = C_{BYP} = 1\text{ }\mu\text{F}$, $T_A = 25^\circ\text{C}$ for typical specifications. $T_J = -40^\circ\text{C}$ to $+125^\circ\text{C}$ for minimum/maximum specifications, unless otherwise noted.

Table 1.

Parameter	Symbol	Test Conditions/Comments	Min	Typ	Max	Unit
INPUT VOLTAGE RANGE	V_{IN}		4.5		16	V
OPERATING SUPPLY CURRENT	I_{GND}	$I_{OUT} = 0\text{ }\mu\text{A}$ $I_{OUT} = 800\text{ mA}$		4.3 8.6	7.0 12	mA mA
SHUTDOWN CURRENT	I_{IN-SD}	$V_{EN} = 0\text{ V}$		0.1	3	μA
OUTPUT NOISE	OUT_{NOISE}	10 Hz to 100 kHz, independent of output voltage 100 Hz to 100 kHz, independent of output voltage		1.6 1.0		$\mu\text{V rms}$ $\mu\text{V rms}$
NOISE SPECTRAL DENSITY	NSD	10 kHz to 1 MHz, independent of output voltage		1.7		nV/ $\sqrt{\text{Hz}}$
POWER SUPPLY REJECTION RATIO	PSRR	1 kHz to 100 kHz, $V_{IN} = 6.2\text{ V}$, $V_{OUT} = 5\text{ V}$ at 800 mA 1 MHz, $V_{IN} = 6.2\text{ V}$, $V_{OUT} = 5\text{ V}$ at 800 mA 1 kHz to 100 kHz, $V_{IN} = 6.2\text{ V}$, $V_{OUT} = 5\text{ V}$ at 400 mA 1 MHz, $V_{IN} = 6.2\text{ V}$, $V_{OUT} = 5\text{ V}$ at 400 mA 1 kHz to 100 kHz, $V_{IN} = 5\text{ V}$, $V_{OUT} = 3.3\text{ V}$ at 800 mA 1 MHz, $V_{IN} = 5\text{ V}$, $V_{OUT} = 3.3\text{ V}$ at 800 mA 1 kHz to 100 kHz, $V_{IN} = 5\text{ V}$, $V_{OUT} = 3.3\text{ V}$ at 400 mA 1 MHz, $V_{IN} = 5\text{ V}$, $V_{OUT} = 3.3\text{ V}$ at 400 mA		86 54 95 62 94 62 95 68		dB dB dB dB dB dB dB dB
V_{OUT} VOLTAGE ACCURACY Voltage Accuracy	V_{OUT}	$V_{OUT} = V_{REF}$ $I_{OUT} = 10\text{ mA}$, $T_J = 25^\circ\text{C}$ 1 mA < I_{OUT} < 800 mA, over line, load and temperature	-1 -2		+1 +2	% %
V_{OUT} REGULATION Line Regulation	$\Delta V_{OUT}/\Delta V_{IN}$	$V_{IN} = V_{OUT} + 1.2\text{ V}$ or $V_{OUT} + 4.5\text{ V}$, whichever is greater, to 16 V	-0.01		+0.01	%/V
Load Regulation ¹	$\Delta V_{OUT}/\Delta I_{OUT}$	$I_{OUT} = 1\text{ mA}$ to 800 mA		0.4	1.0	%/A
V_{OUT} CURRENT-LIMIT THRESHOLD ²	I_{LIMIT}		1.0	1.2	1.6	A
DROPOUT VOLTAGE ³	$V_{DROPOUT}$	$I_{OUT} = 400\text{ mA}$, $V_{OUT} = 5\text{ V}$ $I_{OUT} = 800\text{ mA}$, $V_{OUT} = 5\text{ V}$		0.3 0.6	0.5 1.0	V V
PULL-DOWN RESISTANCE V_{OUT} Pull-Down Resistance V_{REG} Pull-Down Resistance V_{REF} Pull-Down Resistance V_{BYP} Pull-Down Resistance	$V_{OUT-PULL}$ $V_{REG-PULL}$ $V_{REF-PULL}$ $V_{BYP-PULL}$	$V_{EN} = 0\text{ V}$, $V_{OUT} = 1\text{ V}$ $V_{EN} = 0\text{ V}$, $V_{REG} = 1\text{ V}$ $V_{EN} = 0\text{ V}$, $V_{REF} = 1\text{ V}$ $V_{EN} = 0\text{ V}$, $V_{BYP} = 1\text{ V}$		600 34 800 500		Ω k Ω Ω Ω
START-UP TIME ⁴ V_{OUT} Start-Up Time V_{REG} Start-Up Time V_{REF} Start-Up Time	$t_{START-UP}$ $t_{REG-START-UP}$ $t_{REF-START-UP}$	$V_{OUT} = 5\text{ V}$		2.8 1.0 1.8		ms ms ms
THERMAL SHUTDOWN Thermal Shutdown Threshold Thermal Shutdown Hysteresis	TS_{SD} TS_{SD-HYS}	T_J rising		155 15		$^\circ\text{C}$ $^\circ\text{C}$
UNDERVOLTAGE THRESHOLDS Input Voltage Rising Input Voltage Falling Hysteresis	$UVLO_{RISE}$ $UVLO_{FALL}$ $UVLO_{HYS}$		3.85		4.49	V V mV
V_{REG} ⁵ UNDERVOLTAGE THRESHOLDS V_{REG} Rise V_{REG} Fall Hysteresis	$V_{REGUVLO_{RISE}}$ $V_{REGUVLO_{FALL}}$ $V_{REGUVLO_{HYS}}$		2.55		3.1	V V mV

Parameter	Symbol	Test Conditions/Comments	Min	Typ	Max	Unit
EN INPUT		$4.5\text{ V} \leq V_{\text{IN}} \leq 16\text{ V}$				
EN Input Logic High	EN_{HIGH}		3.2			V
EN Input Logic Low	EN_{LOW}				0.8	V
EN Input Logic Hysteresis	EN_{HYS}	$V_{\text{IN}} = 5\text{ V}$		225		mV
EN Input Leakage Current	$I_{\text{EN-LKG}}$	$V_{\text{EN}} = V_{\text{IN}} \text{ or GND}$		0.1	1.0	μA

¹ Based on an end-point calculation using 1 mA and 800 mA loads. See Figure 7, Figure 16, and Figure 22 for typical load regulation performance for loads less than 1 mA.

² Current-limit threshold is defined as the current at which the output voltage drops to 90% of the specified typical value. For example, the current limit for a 5.0 V output voltage is defined as the current that causes the output voltage to drop to 90% of 5.0 V, or 4.5 V.

³ Dropout voltage is defined as the input-to-output voltage differential when the input voltage is set to achieve the nominal output voltage. Dropout applies only for output voltages above 4.5 V.

⁴ Start-up time is defined as the time between the rising edge of V_{EN} to V_{OUT} , V_{REG} , or V_{REF} being at 90% of its nominal value.

⁵ The output voltage is turned off until the V_{REG} UVLO rise threshold is crossed. The V_{REG} output is turned off until the input voltage UVLO rise threshold is crossed.

INPUT AND OUTPUT CAPACITOR RECOMMENDED SPECIFICATIONS

Table 2.

Parameter	Symbol	Test Conditions/Comments	Min	Typ	Max	Unit
CAPACITANCE		$T_{\text{A}} = -40^{\circ}\text{C} \text{ to } +125^{\circ}\text{C}$				
Minimum Input ¹	C_{IN}		7.0			μF
Minimum Regulator ¹	C_{REG}		7.0			μF
Minimum Output ¹	C_{OUT}		7.0			μF
Minimum Bypass	C_{BYP}		0.1			μF
Minimum Reference	C_{REF}		0.7			μF
CAPACITOR Equivalent Series Resistance (ESR)	R_{ESR}	$T_{\text{A}} = -40^{\circ}\text{C} \text{ to } +125^{\circ}\text{C}$				
$C_{\text{REG}}, C_{\text{OUT}}, C_{\text{IN}}, C_{\text{REF}}$			0.001		0.2	Ω
C_{BYP}			0.001		2.0	Ω

¹ The minimum input, regulator, and output capacitance must be greater than 7.0 μF over the full range of operating conditions. The full range of operating conditions in the application must be considered during device selection to ensure that the minimum capacitance specification is met. X7R and X5R type capacitors are recommended; however, Y5V and Z5U capacitors are not recommended for use with any LDO.

ABSOLUTE MAXIMUM RATINGS

Table 3.

Parameter	Rating
VIN to GND	−0.3 V to +18 V
VREG to GND	−0.3 V to VIN, or +6 V (whichever is less)
VOUT to GND	−0.3 V to VREG, or +6 V (whichever is less)
VOUT to BYP	±0.3 V
EN to GND	−0.3 V to +18 V
BYP to GND	−0.3 V to VREG, or +6 V (whichever is less)
REF to GND	−0.3 V to VREG, or +6 V (whichever is less)
REF_SENSE to GND	−0.3 V to +6 V
Storage Temperature Range	−65°C to +150°C
Junction Temperature	150°C
Operating Ambient Temperature Range	−40°C to +125°C
Soldering Conditions	JEDEC J-STD-020

Stresses above those listed under Absolute Maximum Ratings may cause permanent damage to the device. This is a stress rating only; functional operation of the device at these or any other conditions above those indicated in the operational section of this specification is not implied. Exposure to absolute maximum rating conditions for extended periods may affect device reliability.

THERMAL DATA

Absolute maximum ratings apply individually only, not in combination. The ADM7150 can be damaged when the junction temperature limits are exceeded. Monitoring ambient temperature does not guarantee that T_J is within the specified temperature limits. In applications with high power dissipation and poor thermal resistance, the maximum ambient temperature may have to be derated.

In applications with moderate power dissipation and low printed circuit board (PCB) thermal resistance, the maximum ambient temperature can exceed the maximum limit as long as the junction temperature is within specification limits. The junction temperature (T_J) of the device is dependent on the ambient temperature (T_A), the power dissipation of the device (P_D), and the junction to ambient thermal resistance of the package (θ_{JA}).

Maximum junction temperature (T_J) is calculated from the ambient temperature (T_A) and power dissipation (P_D) using the formula

$$T_J = T_A + (P_D \times \theta_{JA})$$

Junction to ambient thermal resistance (θ_{JA}) of the package is based on modeling and calculation using a 4-layer board. The junction to ambient thermal resistance is highly dependent on the application and board layout. In applications where high maximum power dissipation exists, close attention to thermal board design is required. The value of θ_{JA} may vary, depending on PCB material, layout, and environmental conditions. The specified values of θ_{JA} are based on a 4-layer, 4 in. × 3 in. circuit board. See JESD51-7 and JESD51-9 for detailed information on the board construction.

Ψ_{JB} is the junction to board thermal characterization parameter with units of °C/W. Ψ_{JB} of the package is based on modeling and the calculation using a 4-layer board. The JESD51-12, *Guidelines for Reporting and Using Electronic Package Thermal Information*, states that thermal characterization parameters are not the same as thermal resistances. Ψ_{JB} measures the component power flowing through multiple thermal paths rather than a single path as in thermal resistance (θ_{JB}). Therefore, Ψ_{JB} thermal paths include convection from the top of the package as well as radiation from the package, factors that make Ψ_{JB} more useful in real-world applications. Maximum junction temperature (T_J) is calculated from the board temperature (T_B) and power dissipation (P_D) using the formula

$$T_J = T_B + (P_D \times \Psi_{JB})$$

See JESD51-8 and JESD51-12 for more detailed information about Ψ_{JB} .

THERMAL RESISTANCE

θ_{JA} , θ_{JC} , and Ψ_{JB} are specified for the worst-case conditions, that is, a device soldered in a circuit board for surface-mount packages.

Table 4. Thermal Resistance

Package Type	θ_{JA}	θ_{JC}	Ψ_{JB}	Unit
8-Lead LFCSP	36.7	23.5	13.3	°C/W
8-Lead SOIC	36.9	27.1	18.6	°C/W

ESD CAUTION



ESD (electrostatic discharge) sensitive device. Charged devices and circuit boards can discharge without detection. Although this product features patented or proprietary protection circuitry, damage may occur on devices subjected to high energy ESD. Therefore, proper ESD precautions should be taken to avoid performance degradation or loss of functionality.

PIN CONFIGURATIONS AND FUNCTION DESCRIPTIONS

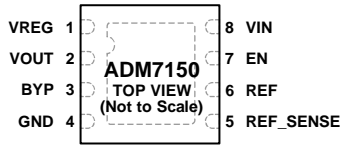

NOTES

1. EXPOSED PAD ON THE BOTTOM OF THE PACKAGE. EXPOSED PAD ENHANCES THERMAL PERFORMANCE AND IS ELECTRICALLY CONNECTED TO GND INSIDE THE PACKAGE. CONNECT THE EXPOSED PAD TO THE GROUND PLANE ON THE BOARD TO ENSURE PROPER OPERATION.

11043-003

Figure 3. 8-Lead LFCSP Pin Configuration

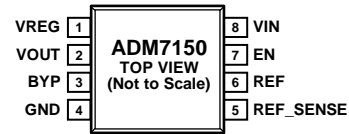

NOTES

1. EXPOSED PAD ON THE BOTTOM OF THE PACKAGE. EXPOSED PAD ENHANCES THERMAL PERFORMANCE AND IS ELECTRICALLY CONNECTED TO GND INSIDE THE PACKAGE. CONNECT THE EXPOSED PAD TO THE GROUND PLANE ON THE BOARD TO ENSURE PROPER OPERATION.

11043-004

Figure 4. 8-Lead SOIC Pin Configuration

Table 5. Pin Function Descriptions

Pin No.	Mnemonic	Description
1	VREG	Regulated Input Supply to LDO Amplifier. Bypass VREG to GND with a 10 μ F or greater capacitor. Do not connect a load to ground.
2	VOUT	Regulated Output Voltage. Bypass VOUT to GND with a 10 μ F or greater capacitor.
3	BYP	Low Noise Bypass Capacitor. Connect a 1 μ F capacitor to GND to reduce noise. Do not connect a load to ground.
4	GND	Ground Connection.
5	REF_SENSE	REF_SENSE must be connected to the REF pin for proper operation. Do not connect to VOUT or GND.
6	REF	Low Noise Reference Voltage Output. Bypass REF to GND with a 1 μ F capacitor. Short REF_SENSE to REF for fixed output voltages. Do not connect a load to ground.
7	EN	Enable. Drive EN high to turn on the regulator and drive EN low to turn off the regulator. For automatic startup, connect EN to VIN.
8	VIN EPAD	Regulator Input Supply. Bypass VIN to GND with a 10 μ F or greater capacitor. Exposed Pad on the Bottom of the Package. The exposed pad enhances thermal performance and is electrically connected to GND inside the package. Connect the exposed pad to the ground plane on the board to ensure proper operation.

TYPICAL PERFORMANCE CHARACTERISTICS

$V_{IN} = V_{OUT} + 1.2\text{ V}$, or $V_{IN} = 4.5\text{ V}$, whichever is greater, $V_{EN} = V_{IN}$, $I_{OUT} = 10\text{ mA}$, $C_{IN} = C_{OUT} = C_{REG} = 10\text{ }\mu\text{F}$, $C_{REF} = C_{BYP} = 1\text{ }\mu\text{F}$, $T_A = 25^\circ\text{C}$, unless otherwise noted.

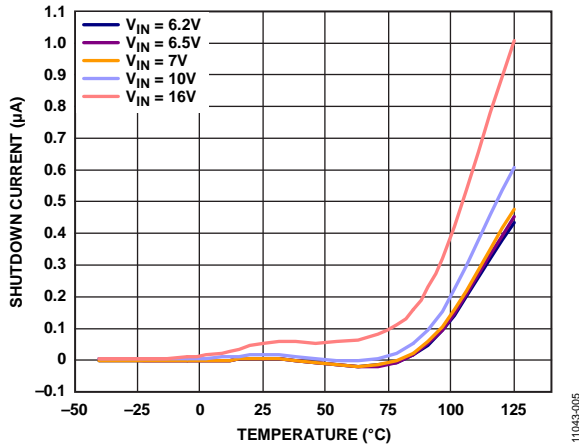

Figure 5. Shutdown Current vs. Temperature at Various Input Voltages, $V_{OUT} = 5\text{ V}$

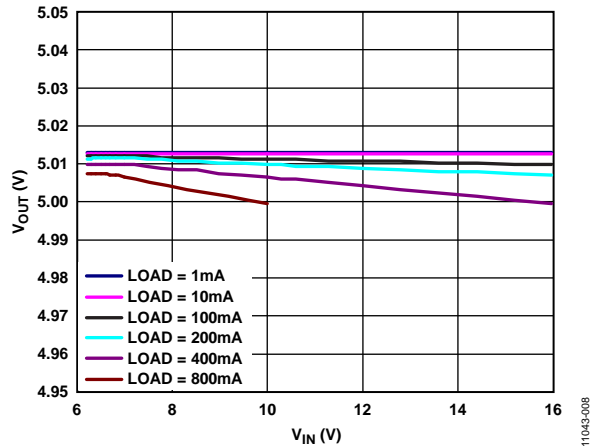

Figure 8. Output Voltage (V_{OUT}) vs. Input Voltage (V_{IN}), $V_{OUT} = 5\text{ V}$

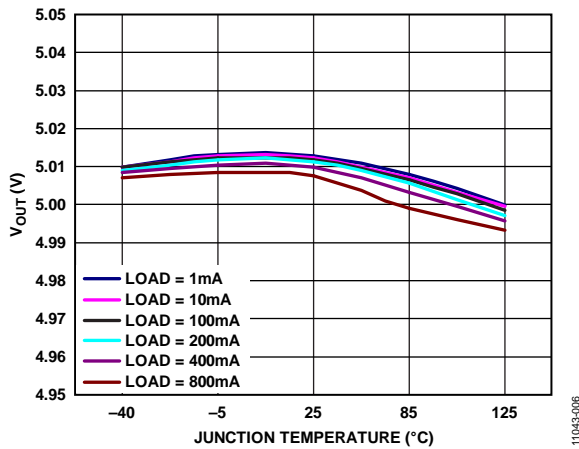

Figure 6. Output Voltage (V_{OUT}) vs. Junction Temperature (T_J), $V_{OUT} = 5\text{ V}$

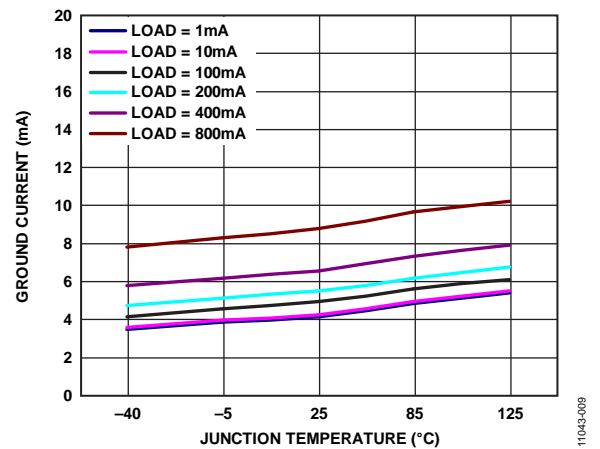

Figure 9. Ground Current vs. Junction Temperature (T_J), $V_{OUT} = 5\text{ V}$

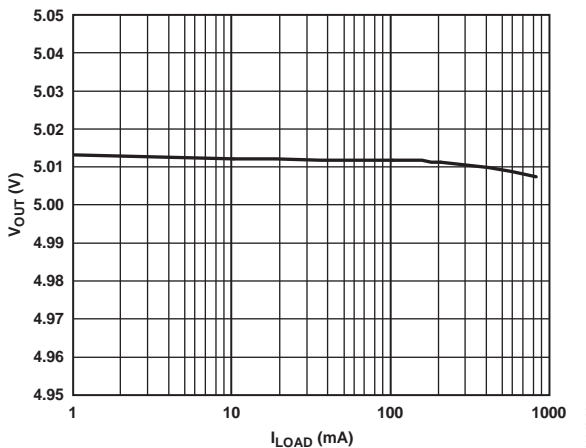

Figure 7. Output Voltage (V_{OUT}) vs. Load Current (I_{LOAD}), $V_{OUT} = 5\text{ V}$

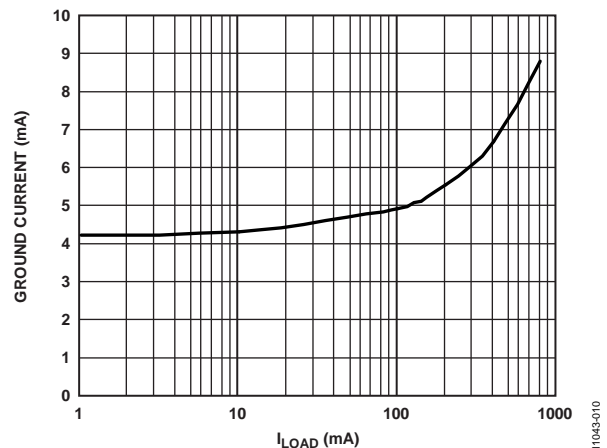

Figure 10. Ground Current vs. Load Current (I_{LOAD}), $V_{OUT} = 5\text{ V}$

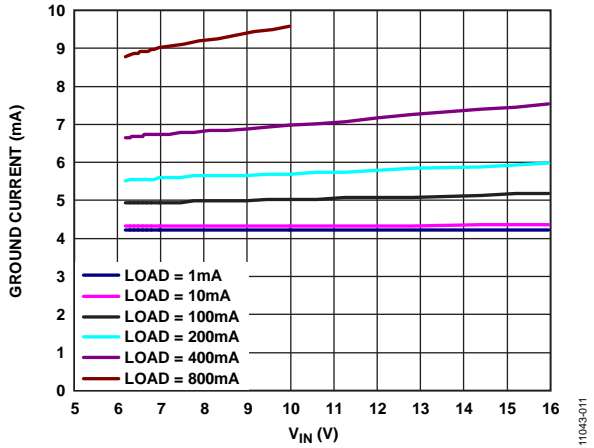

Figure 11. Ground Current vs. Input Voltage (V_{IN}), $V_{OUT} = 5 V$

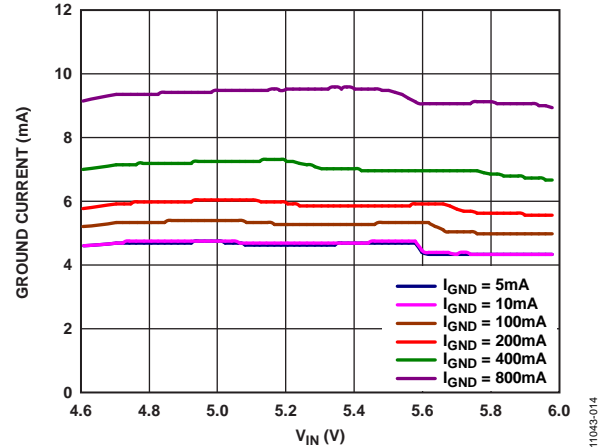

Figure 14. Ground Current vs. Input Voltage (V_{IN}) in Dropout, $V_{OUT} = 5 V$

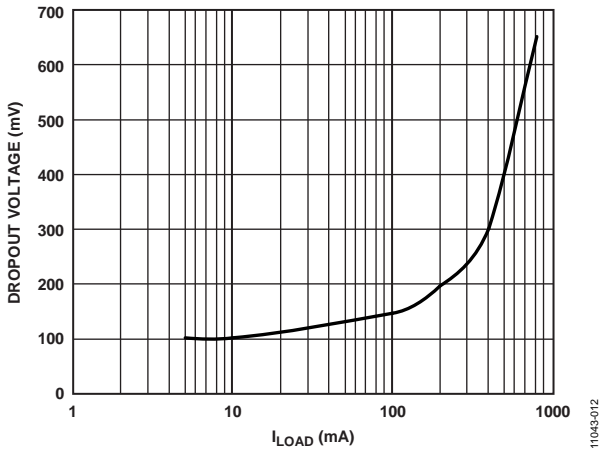

Figure 12. Dropout Voltage vs. Load Current (I_{LOAD}), $V_{OUT} = 5 V$

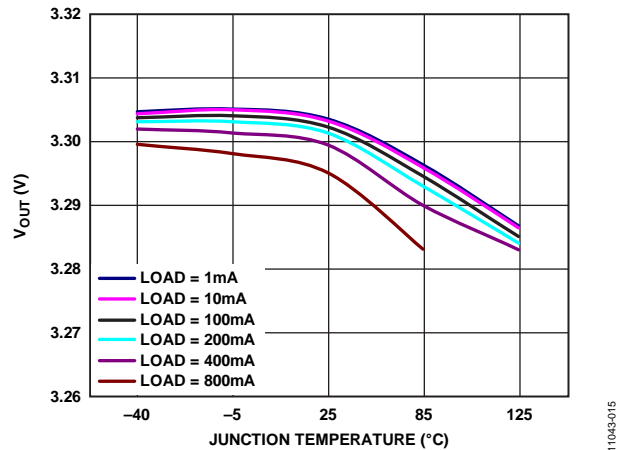

Figure 15. Output Voltage (V_{OUT}) vs. Junction Temperature (T_J), $V_{OUT} = 3.3 V$

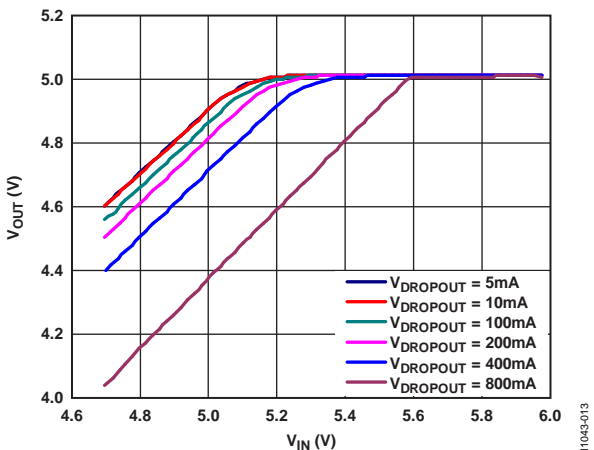

Figure 13. Output Voltage (V_{OUT}) vs. Input Voltage (V_{IN}) in Dropout, $V_{OUT} = 5 V$

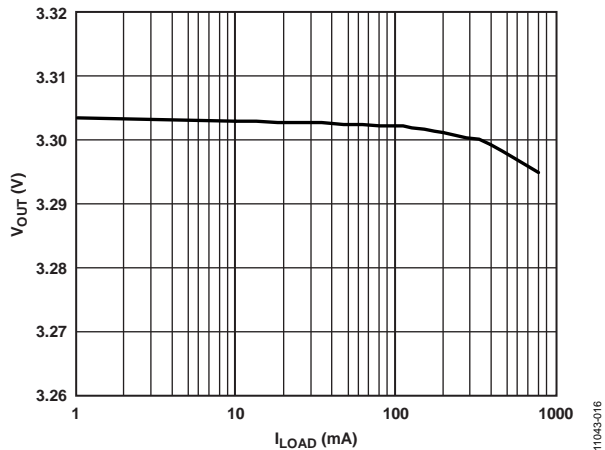

Figure 16. Output Voltage (V_{OUT}) vs. Load Current (I_{LOAD}), $V_{OUT} = 3.3 V$

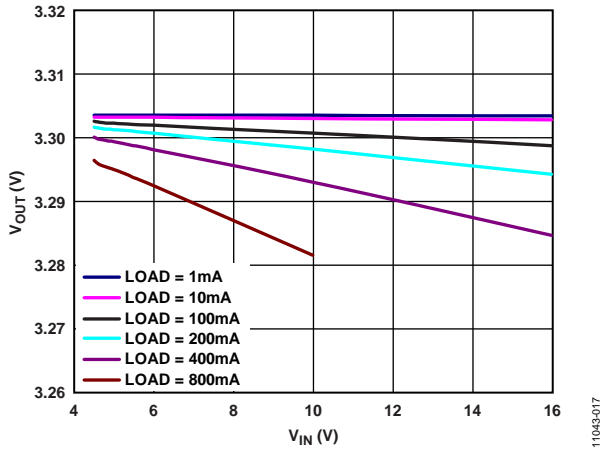

Figure 17. Output Voltage (V_{OUT}) vs. Input Voltage (V_{IN}), $V_{OUT} = 3.3\text{ V}$

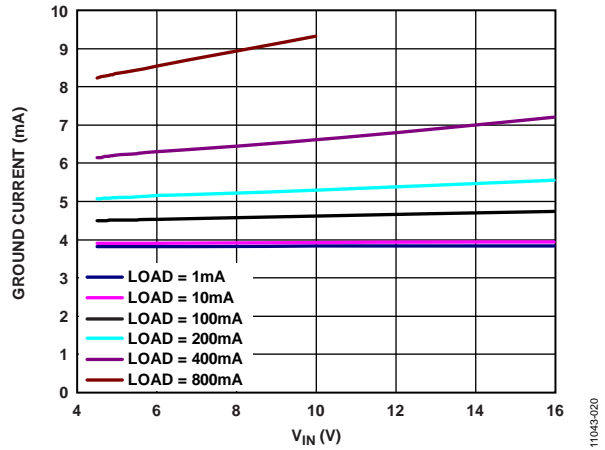

Figure 20. Ground Current vs. Input Voltage (V_{IN}), $V_{OUT} = 3.3\text{ V}$

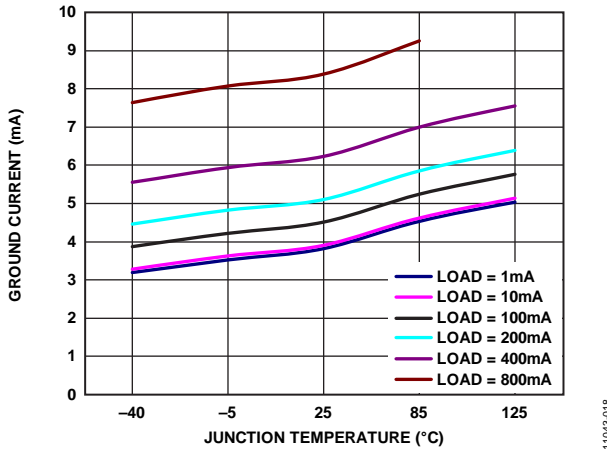

Figure 18. Ground Current vs. Junction Temperature (T_J), $V_{OUT} = 3.3\text{ V}$

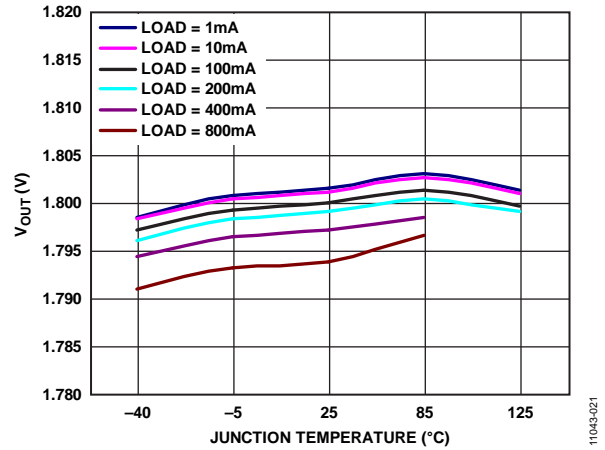

Figure 21. Output Voltage (V_{OUT}) vs. Junction Temperature (T_J), $V_{OUT} = 1.8\text{ V}$

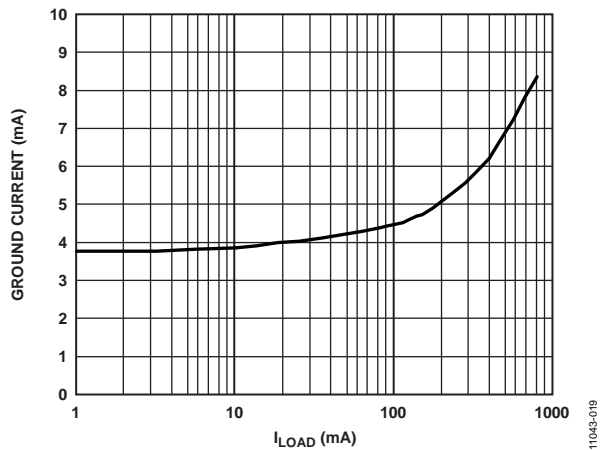

Figure 19. Ground Current vs. Load Current (I_{LOAD}), $V_{OUT} = 3.3\text{ V}$

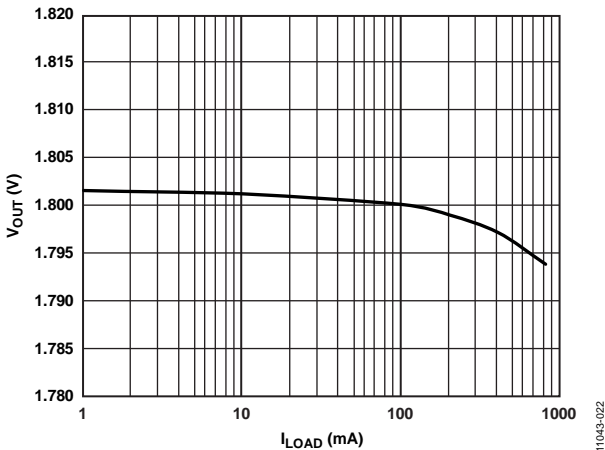

Figure 22. Output Voltage (V_{OUT}) vs. Load Current (I_{LOAD}), $V_{OUT} = 1.8\text{ V}$

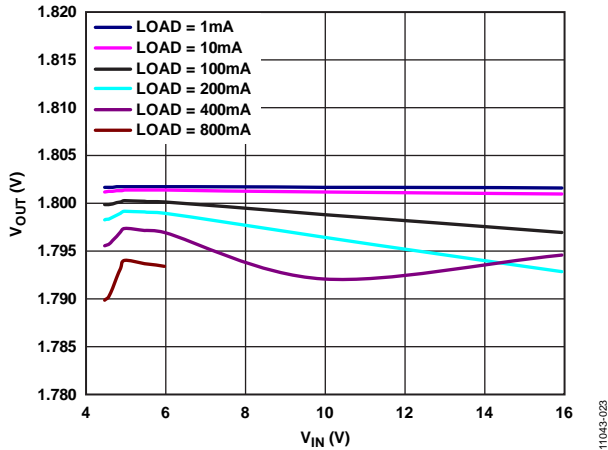

Figure 23. Output Voltage (V_{OUT}) vs. Input Voltage (V_{IN}), $V_{OUT} = 1.8 V$

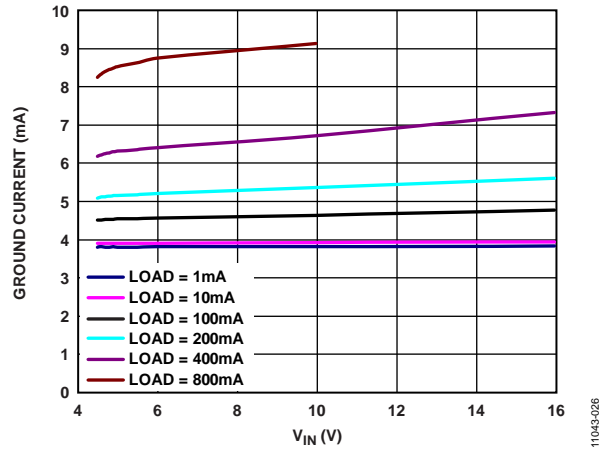

Figure 26. Ground Current vs. Input Voltage (V_{IN}), $V_{OUT} = 1.8 V$

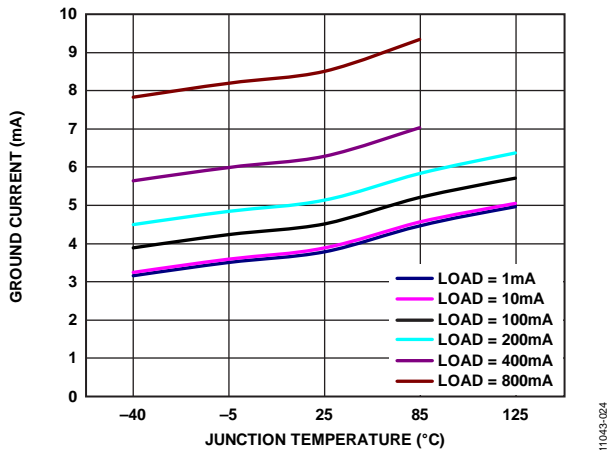

Figure 24. Ground Current vs. Junction Temperature (T_J), $V_{OUT} = 1.8 V$

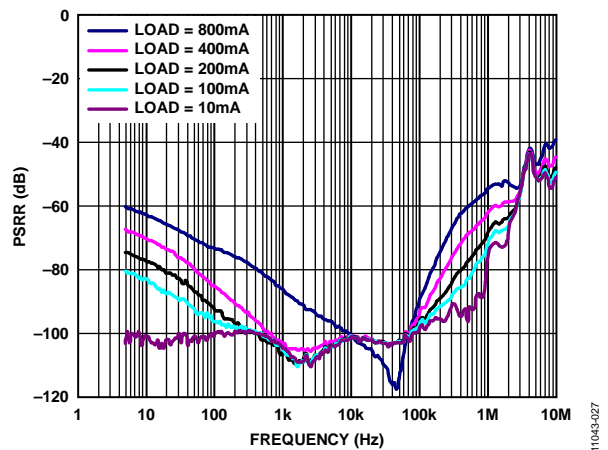

Figure 27. Power Supply Rejection Ratio (PSRR) vs. Frequency, $V_{OUT} = 5 V$, $V_{IN} = 6.2 V$

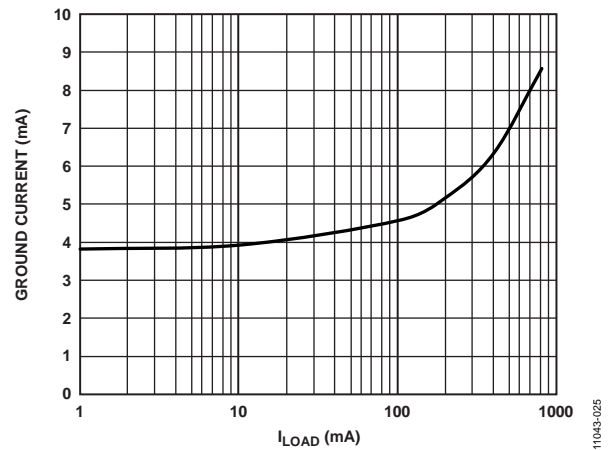

Figure 25. Ground Current vs. Load Current (I_{LOAD}), $V_{OUT} = 1.8 V$

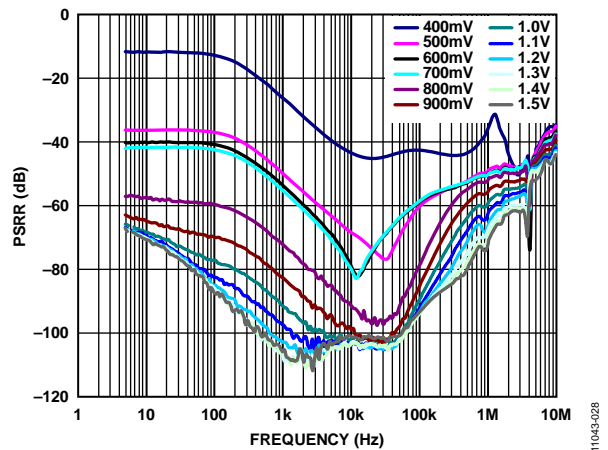

Figure 28. Power Supply Rejection Ratio (PSRR) vs. Frequency for Various Headroom Voltage, $V_{OUT} = 5 V$, 400 mA Load

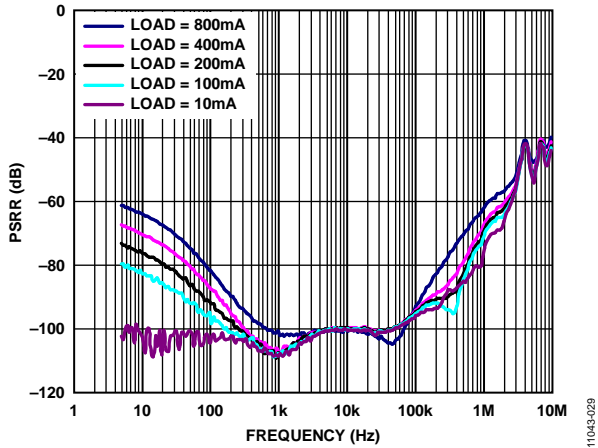

Figure 29. Power Supply Rejection Ratio (PSRR) vs. Frequency, $V_{OUT} = 3.3V$, $V_{IN} = 5V$

11043-029

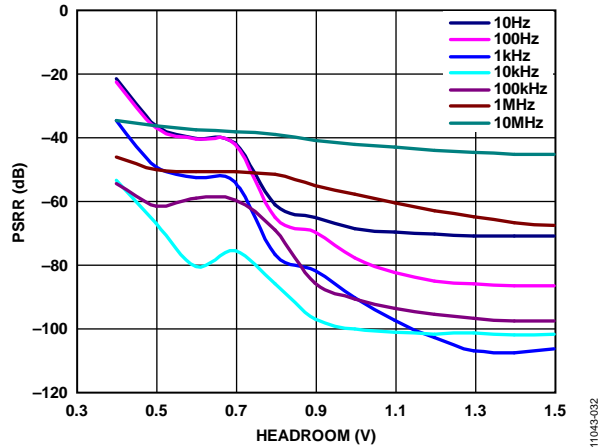

Figure 32. Power Supply Rejection Ratio (PSRR) vs. Headroom Voltage, 400 mA Load, $V_{OUT} = 5V$

11043-032

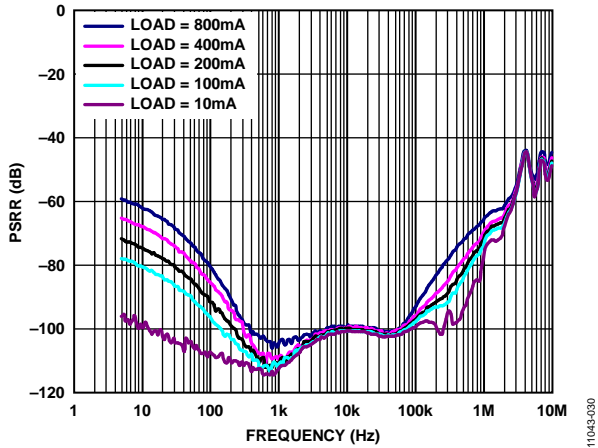

Figure 30. Power Supply Rejection Ratio (PSRR) vs. Frequency, $V_{OUT} = 1.8V$, $V_{IN} = 5V$

11043-030

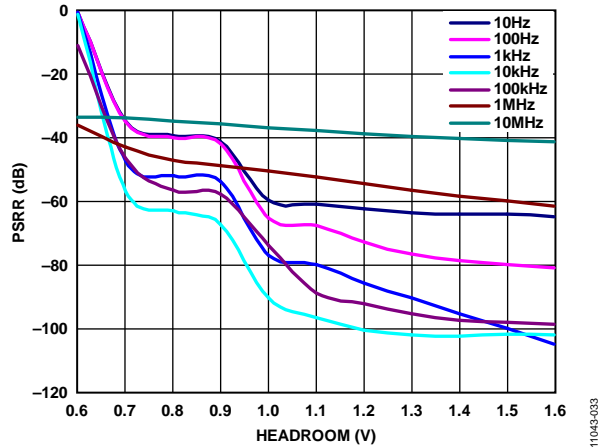

Figure 33. Power Supply Rejection Ratio (PSRR) vs. Headroom Voltage, 800 mA Load, $V_{OUT} = 5V$

11043-033

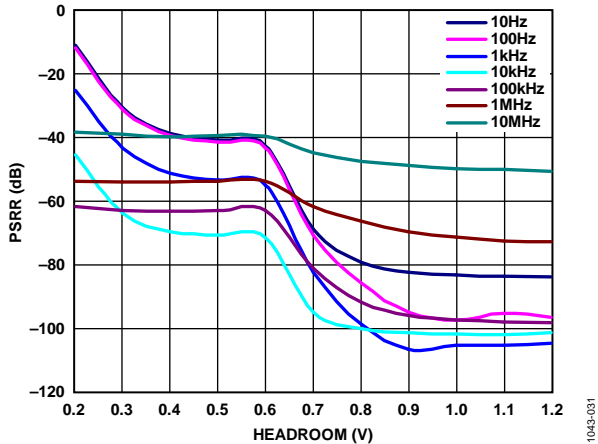

Figure 31. Power Supply Rejection Ratio (PSRR) vs. Headroom Voltage, 100 mA Load, $V_{OUT} = 5V$

11043-031

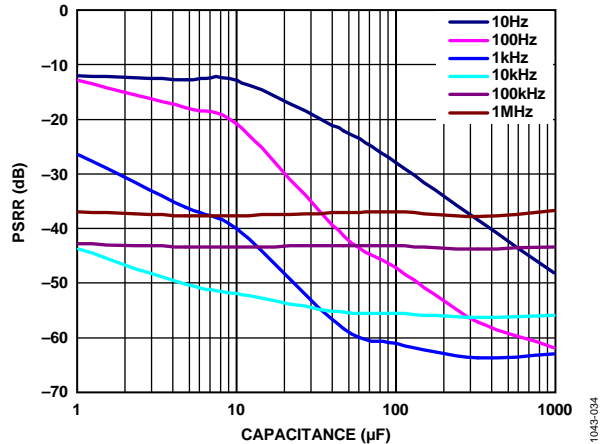

Figure 34. Power Supply Rejection Ratio (PSRR) vs. C_{BYP} , 400 mA Load, 400 mV Headroom, $V_{OUT} = 5V$

11043-034

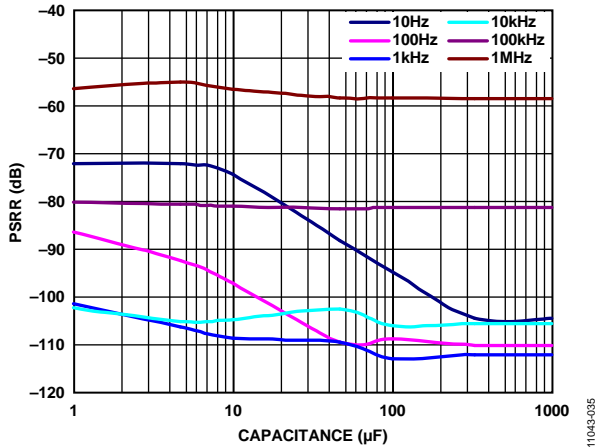

Figure 35. Power Supply Rejection Ratio (PSRR) vs. Capacitance (C_{BYP}), 400 mA Load, 1.2 V Headroom, $V_{OUT} = 5 V$

11043-035

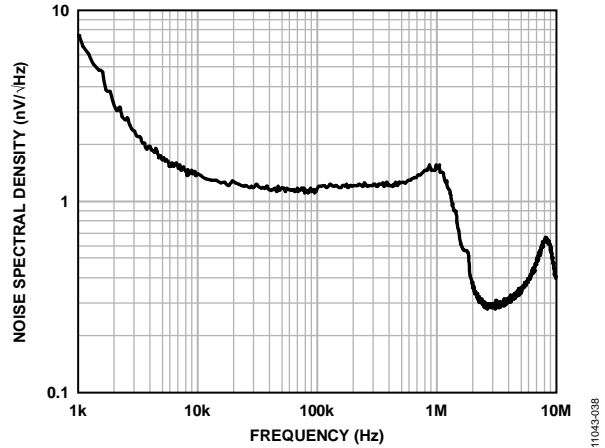

Figure 38. Output Noise Spectral Density, 1 kHz to 10 MHz, $I_{LOAD} = 10 mA$

11043-038

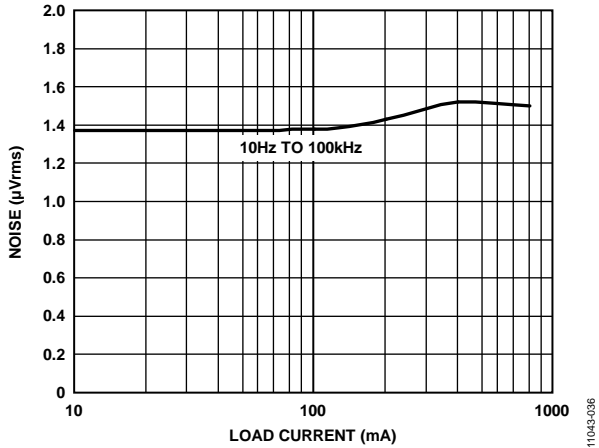

Figure 36. RMS Output Noise vs. Load Current (I_{LOAD}), 10 Hz to 100 kHz

11043-036

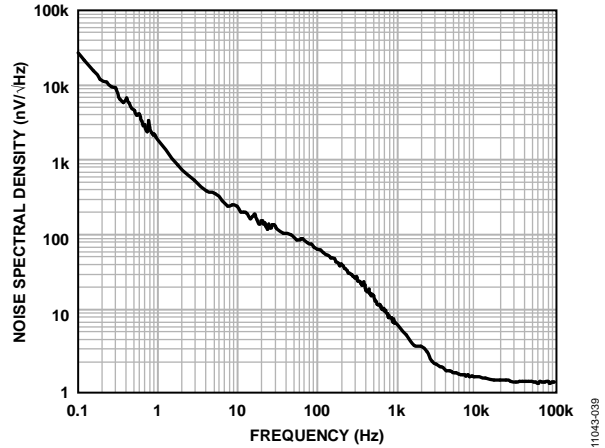

Figure 39. Output Noise Spectral Density, 0.1 Hz to 100 kHz, $I_{LOAD} = 10 mA$

11043-039

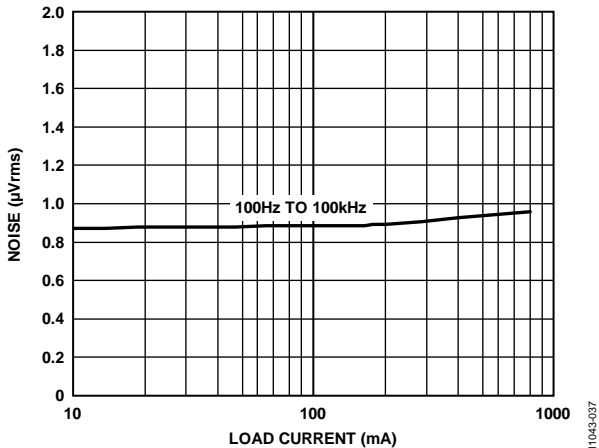

Figure 37. RMS Output Noise vs. Load Current (I_{LOAD}), 100 Hz to 100 kHz

11043-037

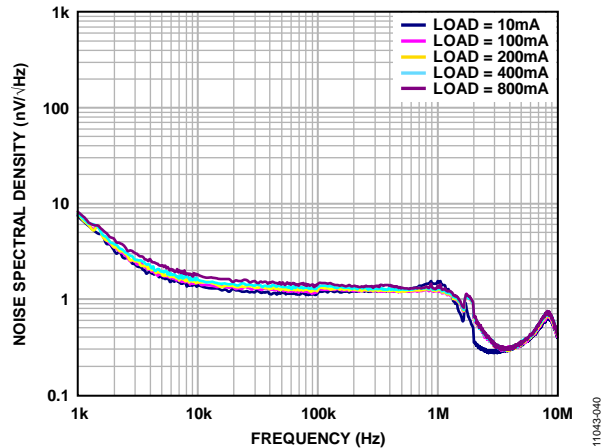

Figure 40. Output Noise Spectral Density at Different Load Currents, 1 kHz to 10 MHz

11043-040

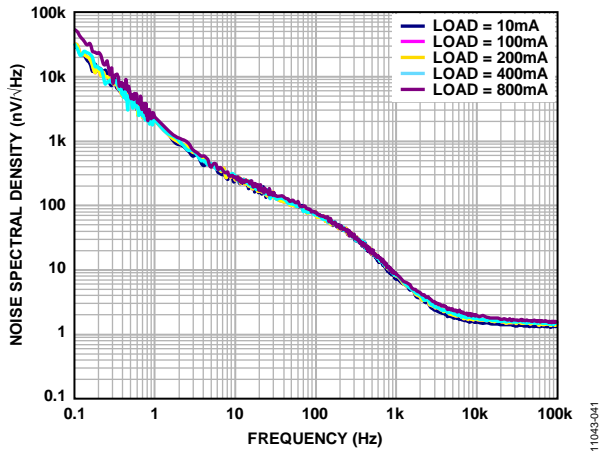

Figure 41. Output Noise Spectral Density at Different Load Currents, 0.1 Hz to 100 kHz

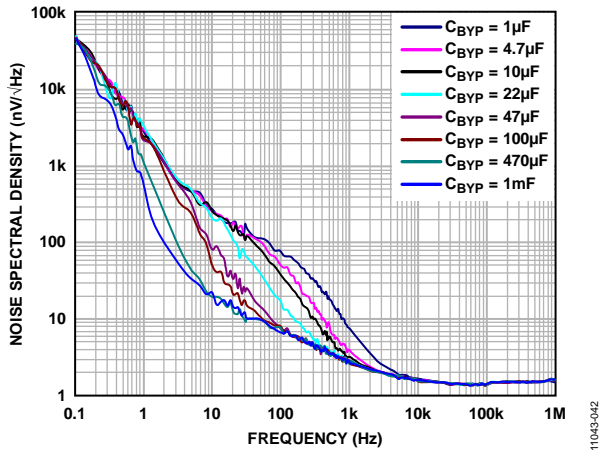

Figure 42. Output Noise Spectral Density at Different C_{BYP} , Load Current = 10 mA

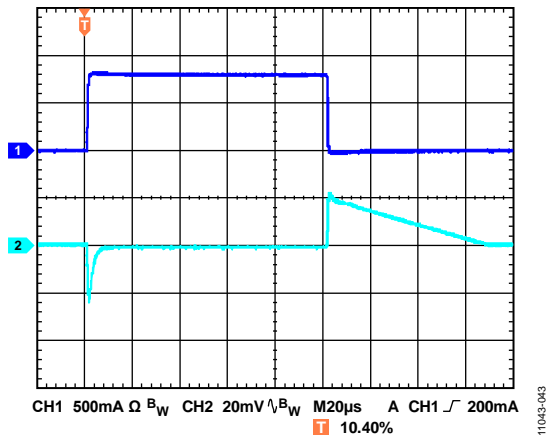

Figure 43. Load Transient Response, $I_{LOAD} = 1 \text{ mA}$ to 800 mA , $V_{OUT} = 5 \text{ V}$, $V_{IN} = 6.2 \text{ V}$, $CH1 = I_{OUT}$, $CH2 = V_{OUT}$

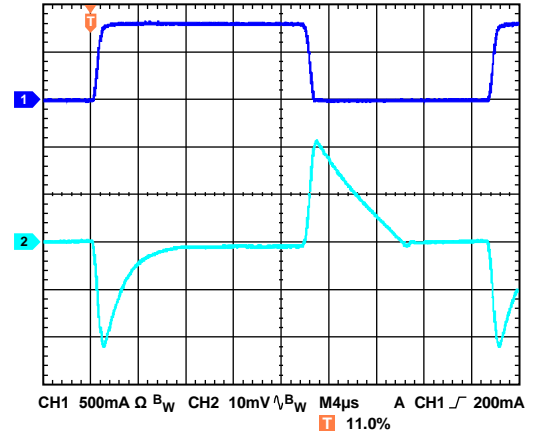

Figure 44. Load Transient Response, $I_{LOAD} = 10 \text{ mA}$ to 800 mA , $V_{OUT} = 5 \text{ V}$, $V_{IN} = 6.2 \text{ V}$, $CH1 = I_{OUT}$, $CH2 = V_{OUT}$

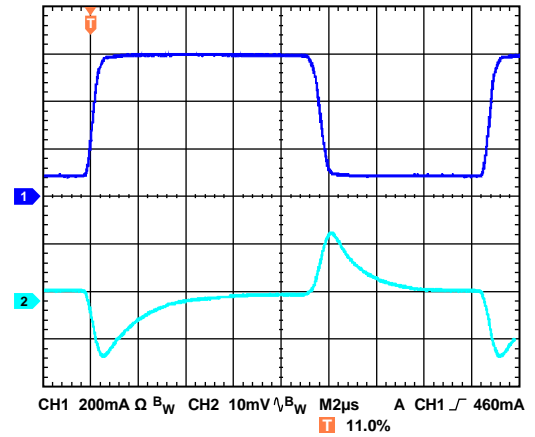

Figure 45. Load Transient Response, $I_{LOAD} = 100 \text{ mA}$ to 600 mA , $V_{OUT} = 5 \text{ V}$, $V_{IN} = 6.2 \text{ V}$, $CH1 = I_{OUT}$, $CH2 = V_{OUT}$

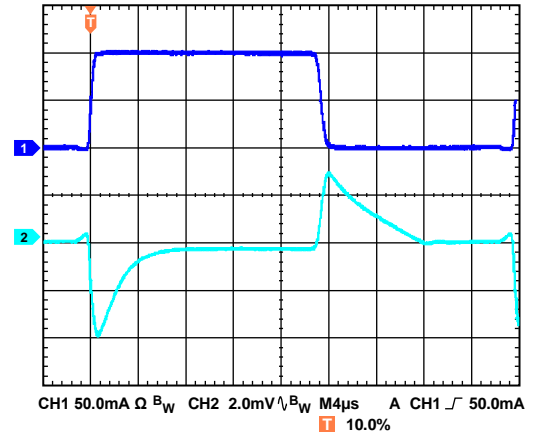

Figure 46. Load Transient Response, $I_{LOAD} = 1 \text{ mA}$ to 100 mA , $V_{OUT} = 5 \text{ V}$, $V_{IN} = 6.2 \text{ V}$, $CH1 = I_{OUT}$, $CH2 = V_{OUT}$

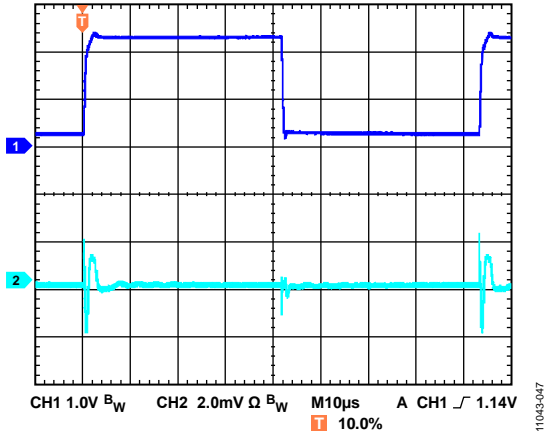

Figure 47. Line Transient Response, 2 V Input Step, $I_{LOAD} = 800\text{ mA}$, $V_{OUT} = 1.8\text{ V}$, $V_{IN} = 4.5\text{ V}$, CH1 = V_{IN} , CH2 = V_{OUT}

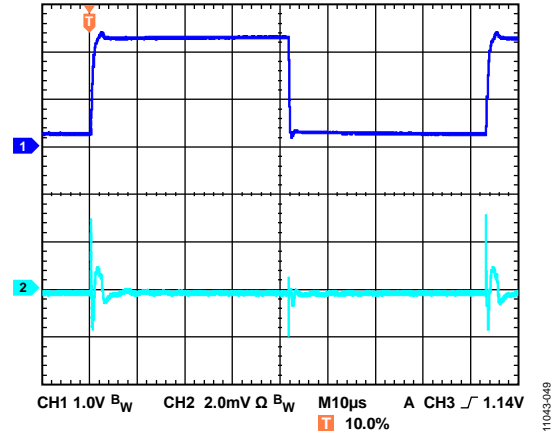

Figure 49. Line Transient Response, 2 V Input Step, $I_{LOAD} = 800\text{ mA}$, $V_{OUT} = 5\text{ V}$, $V_{IN} = 6.2\text{ V}$, CH1 = V_{IN} , CH2 = V_{OUT}

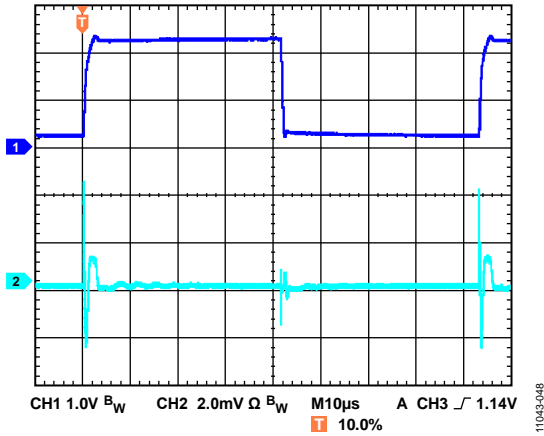

Figure 48. Line Transient Response, 2 V Input Step, $I_{LOAD} = 800\text{ mA}$, $V_{OUT} = 3.3\text{ V}$, $V_{IN} = 4.5\text{ V}$, CH1 = V_{IN} , CH2 = V_{OUT}

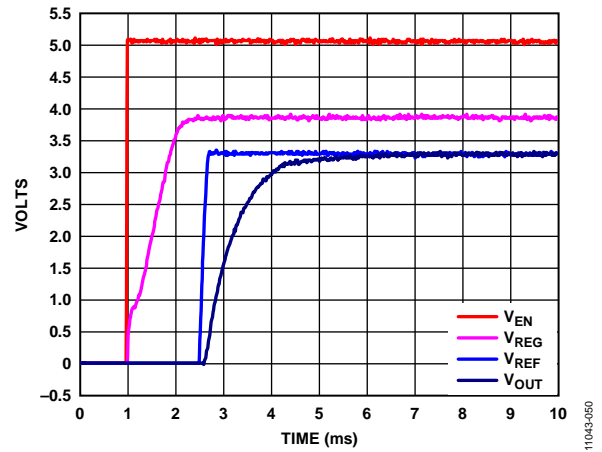

Figure 50. V_{OUT} , V_{REF} , V_{REG} Start-Up Time After V_{EN} Rising, $V_{OUT} = 3.3\text{ V}$, $V_{IN} = 5\text{ V}$

THEORY OF OPERATION

The **ADM7150** is an ultralow noise, high power supply rejection ratio (PSRR) linear regulator targeting radio frequency (RF) applications. The input voltage range is 4.5 V to 16 V, and it can deliver up to 800 mA of output current. Typical shutdown current consumption is 0.1 μ A at room temperature.

Optimized for use with 10 μ F ceramic capacitors, the **ADM7150** provides excellent transient performance.

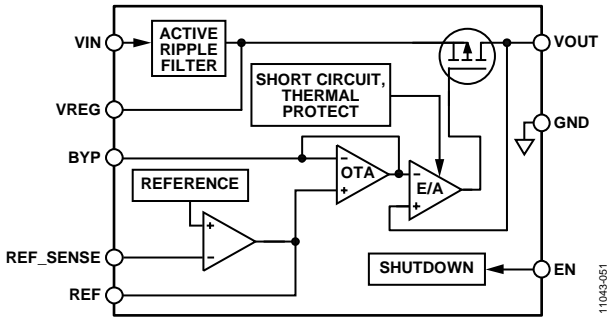

Figure 51. Simplified Internal Block Diagram

Internally, the **ADM7150** consists of a reference, an error amplifier, and a P-channel MOSFET pass transistor. Output current is delivered via the PMOS pass device, which is controlled by the error amplifier. The error amplifier compares the reference voltage with the feedback voltage from the output and amplifies the difference. If the feedback voltage is lower than the reference voltage, the gate of the PMOS device is pulled lower, allowing more current to pass and increasing the output voltage. If the feedback voltage is higher than the reference voltage, the gate of the PMOS device is pulled higher, allowing less current to pass and decreasing the output voltage.

By heavily filtering the reference voltage, the **ADM7150** is able to achieve 1.7 nV/ $\sqrt{\text{Hz}}$ output typical from 10 kHz to 1 MHz. Because the error amplifier is always in unity gain, the output noise is independent of the output voltage.

To maintain very high PSRR over a wide frequency range, the **ADM7150** architecture uses an internal active ripple filter. This stage isolates the low output noise LDO from noise on VIN. The result is that the PSRR of the **ADM7150** is significantly higher over a wider frequency range than any single stage LDO.

The **ADM7150** uses the EN pin to enable and disable the VOUT pin under normal operating conditions. When EN is high, VOUT turns on, and when EN is low, VOUT turns off. For automatic startup, EN can be tied to VIN.

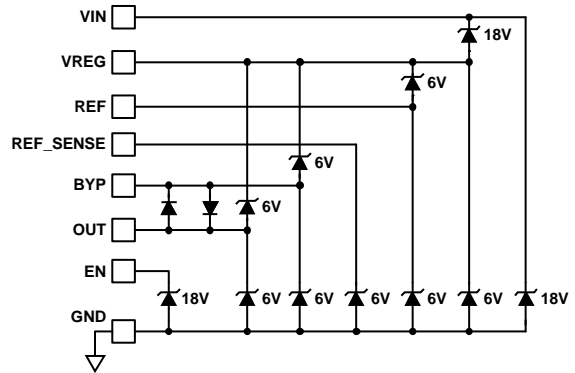

Figure 52. Simplified ESD Protection Block Diagram

The ESD protection devices are shown in the block diagram as Zener diodes (see Figure 52).

APPLICATIONS INFORMATION

CAPACITOR SELECTION

Output Capacitor

The ADM7150 is designed for operation with ceramic capacitors but functions with most commonly used capacitors as long as care is taken with regard to the effective series resistance (ESR) value. The ESR of the output capacitor affects the stability of the LDO control loop. A minimum of 10 μF capacitance with an ESR of 0.2 Ω or less is recommended to ensure the stability of the ADM7150. Output capacitance also affects transient response to changes in load current. Using a larger value of output capacitance improves the transient response of the ADM7150 to large changes in load current. Figure 53 shows the transient responses for an output capacitance value of 10 μF .

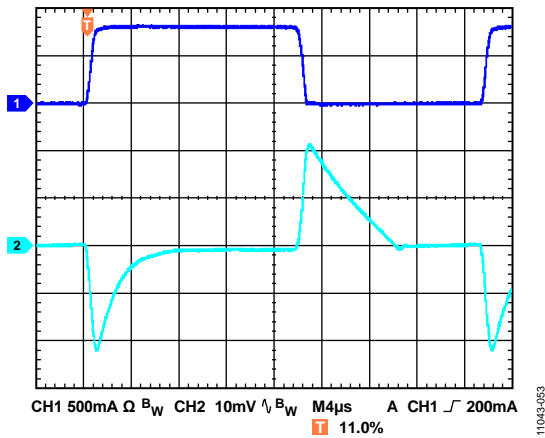

Figure 53. Output Transient Response, $V_{OUT} = 5\text{ V}$, $C_{OUT} = 10\ \mu\text{F}$, CH1 = Load Current, CH2 = V_{OUT}

Input and VREG Capacitor

Connecting a 10 μF capacitor from VIN to GND reduces the circuit sensitivity to PCB layout, especially when long input traces or high source impedance are encountered.

To maintain the best possible stability and PSRR performance, connect a 10 μF capacitor from VREG to GND. When more than 10 μF of output capacitance is required, increase the input and VREG capacitors to match it.

REF Capacitor

The REF capacitor is necessary to stabilize the reference amplifier. Connect at least a 1 μF capacitor between REF and GND.

BYP Capacitor

The BYP capacitor is necessary to filter the reference buffer. A 1 μF capacitor is typically connected between BYP and GND. Capacitors as small as 0.1 μF can be used; however, the output noise voltage of the LDO increases as a result.

In addition, the BYP capacitor value can be increased to reduce the noise below 1 kHz at the expense of increasing the start-up time of the LDO. Very large values of C_{BYP} significantly reduce the noise below 10 Hz. Tantalum capacitors are recommended for capacitors larger than approximately 33 μF . A 1 μF ceramic capacitor in parallel with the larger tantalum capacitor is required to retain good noise performance at higher frequencies. Solid tantalum capacitors are less prone to microphonic noise issues.

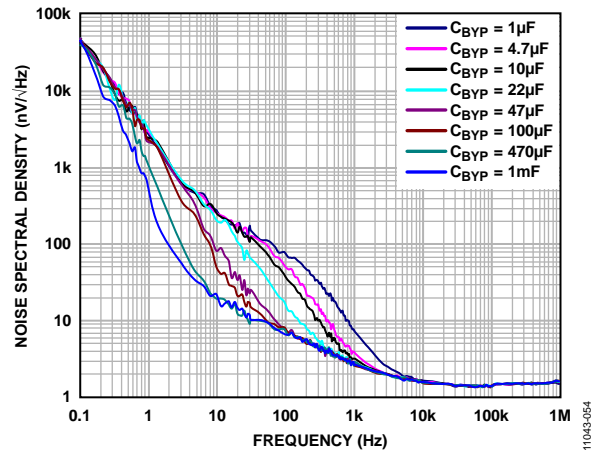

Figure 54. Noise Spectral Density vs. Frequency, $C_{BYP} = 1\ \mu\text{F}$ to 1 mF

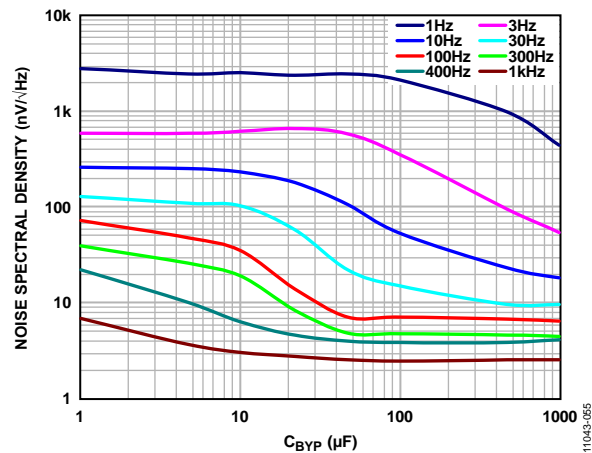

Figure 55. Noise Spectral Density vs. Capacitance (C_{BYP}) for Different Frequencies

Capacitor Properties

Any good quality ceramic capacitors can be used with the ADM7150 as long as they meet the minimum capacitance and maximum ESR requirements. Ceramic capacitors are manufactured with a variety of dielectrics, each with different behavior over temperature and applied voltage. Capacitors must have a dielectric adequate to ensure the minimum capacitance over the necessary temperature range and dc bias conditions. X5R or X7R dielectrics with a voltage rating of 6.3 V to 50 V are recommended. However, Y5V and Z5U dielectrics are not recommended due to their poor temperature and dc bias characteristics.

Figure 56 depicts the capacitance vs. dc bias voltage of a 1206, 10 μF, 10 V, X5R capacitor. The voltage stability of a capacitor is strongly influenced by the capacitor size and voltage rating. In general, a capacitor in a larger package or higher voltage rating exhibits better stability. The temperature variation of the X5R dielectric is ~±15% over the -40°C to +85°C temperature range and is not a function of package or voltage rating.

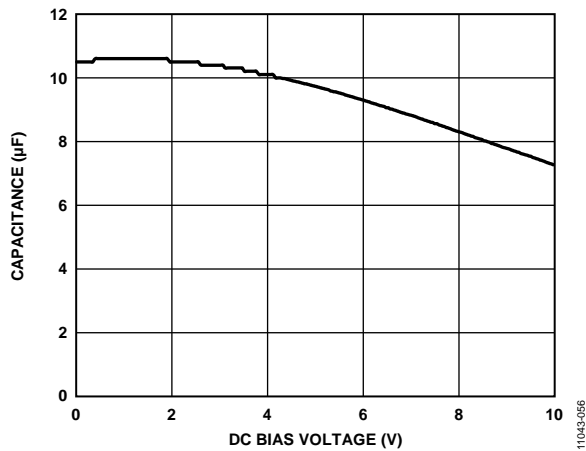

Figure 56. Capacitance vs. DC Bias Voltage

Use Equation 1 to determine the worst-case capacitance accounting for capacitor variation over temperature, component tolerance, and voltage.

$$C_{EFF} = C_{BIAS} \times (1 - TEMPCO) \times (1 - TOL) \tag{1}$$

where:

C_{BIAS} is the effective capacitance at the operating voltage.
 $TEMPCO$ is the worst-case capacitor temperature coefficient.
 TOL is the worst-case component tolerance.

In this example, the worst-case temperature coefficient (TEMPCO) over -40°C to +85°C is assumed to be 15% for an X5R dielectric. The tolerance of the capacitor (TOL) is assumed to be 10%, and C_{BIAS} is 9.72 μF at 5 V, as shown in Figure 56.

Substituting these values in Equation 1 yields

$$C_{EFF} = 9.72 \mu\text{F} \times (1 - 0.15) \times (1 - 0.1) = 7.44 \mu\text{F}$$

Therefore, the capacitor chosen in this example meets the minimum capacitance requirement of the LDO over temperature and tolerance at the chosen output voltage.

To guarantee the performance of the ADM7150, it is imperative that the effects of dc bias, temperature, and tolerances on the behavior of the capacitors be evaluated for each application.

ENABLE (EN) AND UNDERVOLTAGE LOCKOUT (UVLO)

The ADM7150 uses the EN pin to enable and disable the VOUT pin under normal operating conditions. As shown in Figure 57, when a rising voltage on EN crosses the upper threshold, VOUT turns on. When a falling voltage on EN crosses the lower threshold, VOUT turns off. The hysteresis varies as a function of the input voltage. For example, the EN hysteresis is approximately 200 mV with an input voltage of 4.5 V.

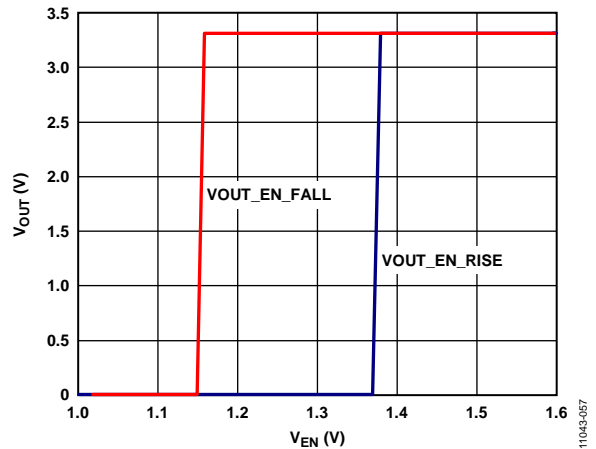

Figure 57. Typical VOUT Response to EN Pin Operation, VOUT = 3.3 V, VIN = 5 V

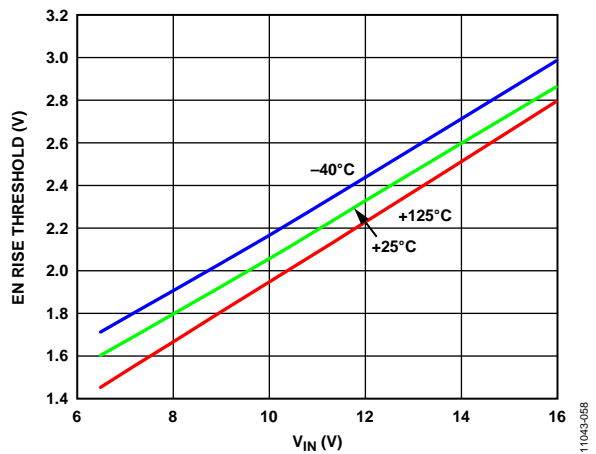

Figure 58. Typical EN Rise Threshold vs. Input Voltage (VIN) for Various Temperatures

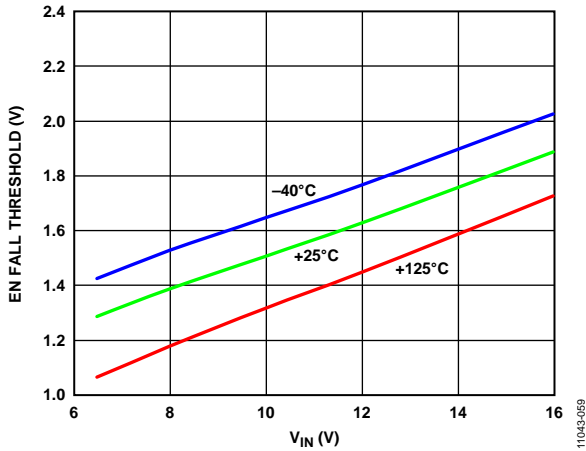

Figure 59. Typical EN Fall Threshold vs. Input Voltage (V_{IN}) for Various Temperatures

The ADM7150 also incorporates an internal undervoltage lockout circuit to disable the output voltage when the input voltage is less than the minimum input voltage rating of the regulator. The upper and lower thresholds are internally fixed with about 300 mV of hysteresis.

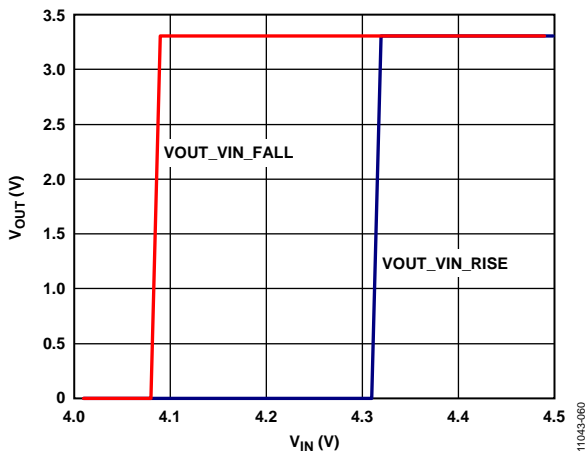

Figure 60. Typical UVLO Hysteresis, $V_{OUT} = 3.3\text{ V}$

Figure 60 shows the typical hysteresis of the UVLO function. This hysteresis prevents on/off oscillations that can occur due to noise on the input voltage as it passes through the threshold points.

START-UP TIME

The ADM7150 uses an internal soft start to limit the inrush current when the output is enabled. The start-up time for a 5 V output is approximately 3 ms from the time the EN active threshold is crossed to when the output reaches 90% of its final value.

The rise time of the output voltage (10% to 90%) is approximately

$$0.0012 \times C_{BYP} \text{ seconds}$$

where C_{BYP} is in microfarads.

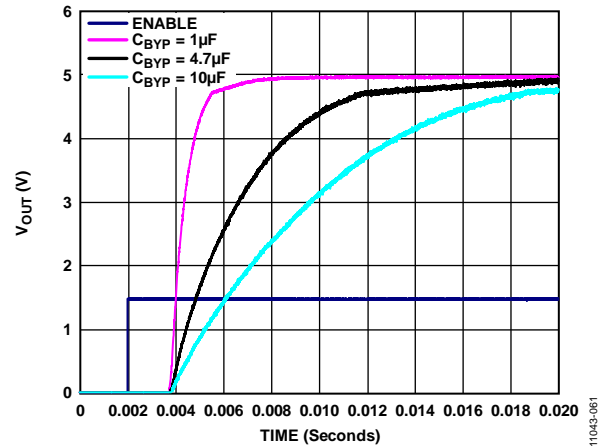

Figure 61. Typical Start-Up Behavior with $C_{BYP} = 1\ \mu\text{F}$ to $10\ \mu\text{F}$

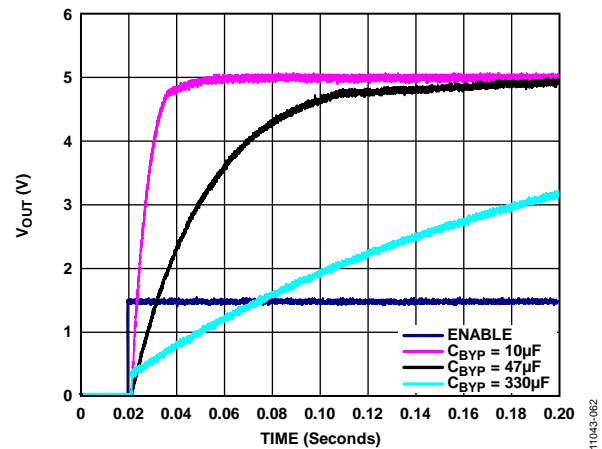

Figure 62. Typical Start-Up Behavior with $C_{BYP} = 10\ \mu\text{F}$ to $330\ \mu\text{F}$

REF, BYP, AND, VREG PINS

REF, BYP, and VREG are internally generated voltages that require external bypass capacitors for proper operation. Do not, under any circumstances, connect any loads to these pins because doing so compromises the noise and PSRR performance of the ADM7150. Using larger values of C_{BYP} , C_{REF} , and C_{REG} is acceptable but can increase the start-up time as described in the Start-Up Time section.

CURRENT-LIMIT AND THERMAL OVERLOAD PROTECTION

The ADM7150 is protected against damage due to excessive power dissipation by current and thermal overload protection circuits. The ADM7150 is designed to current-limit when the output load reaches 1.2 A (typical). When the output load exceeds 1.2 A, the output voltage is reduced to maintain a constant current limit.

Thermal overload protection is included, which limits the junction temperature to a maximum of 155°C (typical). Under extreme conditions (that is, high ambient temperature and/or high power dissipation) when the junction temperature starts to rise above 155°C, the output is turned off, reducing the output current to zero. When the junction temperature drops below 140°C, the output is turned on again, and output current is restored to its operating value.

Consider the case where a hard short from VOUT to GND occurs. At first, the ADM7150 current limits, so that only 1.2 A is conducted into the short. If self heating of the junction is great enough to cause its temperature to rise above 155°C, thermal shutdown activates, turning off the output and reducing the output current to zero. As the junction temperature cools and drops below 140°C, the output turns on and conducts 1.2 A into the short, again causing the junction temperature to rise above 155°C. This thermal oscillation between 140°C and 155°C causes a current oscillation between 1.2 A and 0 mA that continues as long as the short remains at the output.

Current-limit and thermal limit protections are intended to protect the device against accidental overload conditions. For reliable operation, device power dissipation must be externally limited so that the junction temperature does not exceed 150°C.

THERMAL CONSIDERATIONS

In applications with low input to output voltage differential, the ADM7150 does not dissipate much heat. However, in applications with high ambient temperature and/or high input voltage, the heat dissipated in the package may become large enough that it causes the junction temperature of the die to exceed the maximum junction temperature of 150°C.

When the junction temperature exceeds 155°C, the converter enters thermal shutdown. It recovers only after the junction temperature decreases below 140°C to prevent any permanent damage. Therefore, thermal analysis for the chosen application is important to guarantee reliable performance over all conditions. The junction temperature of the die is the sum of the ambient temperature of the environment and the temperature rise of the package due to the power dissipation, as shown in Equation 2.

To guarantee reliable operation, the junction temperature of the ADM7150 must not exceed 150°C. To ensure that the junction temperature stays below this maximum value, the user must be aware of the parameters that contribute to junction temperature changes. These parameters include ambient temperature, power dissipation in the power device, and thermal resistances

between the junction and ambient air (θ_{JA}). The θ_{JA} number is dependent on the package assembly compounds that are used and the amount of copper used to solder the package GND pin and exposed pad to the PCB.

Table 6 shows typical θ_{JA} values of the 8-lead SOIC and 8-lead LFCSP packages for various PCB copper sizes.

Table 7 shows the typical Ψ_{JB} values of the 8-lead SOIC and 8-lead LFCSP.

Table 6. Typical θ_{JA} Values

Copper Size (mm ²)	θ_{JA} (°C/W)	
	8-Lead LFCSP	8-Lead SOIC
25 ¹	165.1	165
100	125.8	126.4
500	68.1	69.8
1000	56.4	57.8
6400	42.1	43.6

¹ Device soldered to minimum size pin traces.

Table 7. Typical Ψ_{JB} Values

Package	Ψ_{JB} (°C/W)
8-Lead LFCSP	15.1
8-Lead SOIC	17.9

The junction temperature of the ADM7150 is calculated from the following equation:

$$T_J = T_A + (P_D \times \theta_{JA}) \quad (2)$$

where:

T_A is the ambient temperature.

P_D is the power dissipation in the die, given by

$$P_D = [(V_{IN} - V_{OUT}) \times I_{LOAD}] + (V_{IN} \times I_{GND}) \quad (3)$$

where:

V_{IN} and V_{OUT} are the input and output voltages, respectively.

I_{LOAD} is the load current.

I_{GND} is the ground current.

Power dissipation due to ground current is quite small and can be ignored. Therefore, the junction temperature equation simplifies to the following:

$$T_J = T_A + \{[(V_{IN} - V_{OUT}) \times I_{LOAD}] \times \theta_{JA}\} \quad (4)$$

As shown in Equation 4, for a given ambient temperature, input to output voltage differential, and continuous load current, there exists a minimum copper size requirement for the PCB to ensure that the junction temperature does not rise above 150°C.

The heat dissipation from the package can be improved by increasing the amount of copper attached to the pins and exposed pad of the ADM7150. Adding thermal planes under the package also improves thermal performance. However, as listed in Table 6, a point of diminishing returns is eventually reached, beyond which an increase in the copper area does not yield significant reduction in the junction to ambient thermal resistance.

Figure 63 to Figure 68 show junction temperature calculations for different ambient temperatures, power dissipation, and areas of PCB copper.

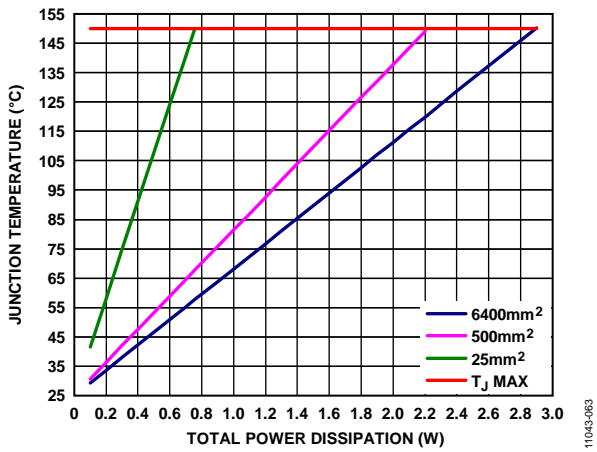

Figure 63. Junction Temperature vs. Total Power Dissipation for the 8-Lead LFCSP, $T_A = 25^\circ\text{C}$

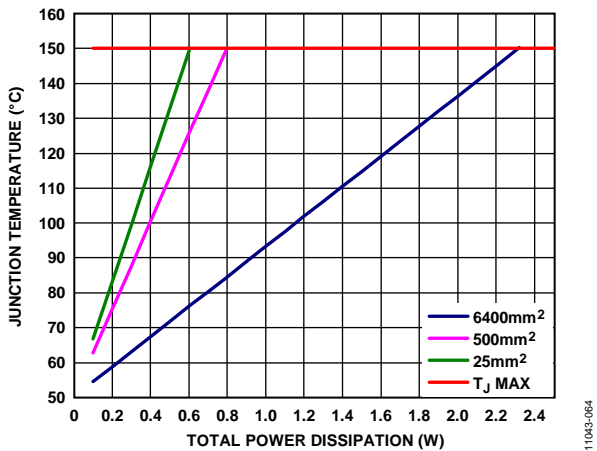

Figure 64. Junction Temperature vs. Total Power Dissipation for the 8-Lead LFCSP, $T_A = 50^\circ\text{C}$

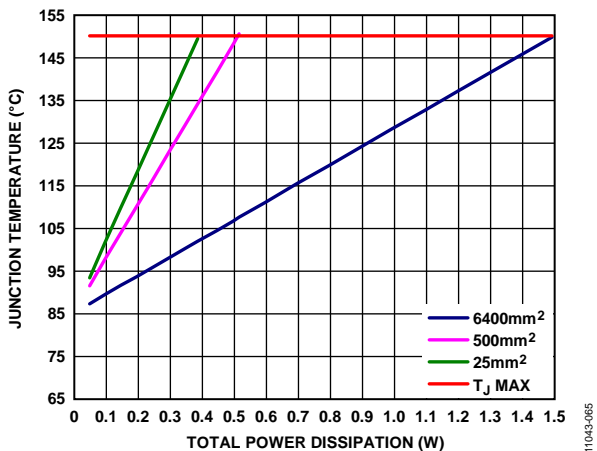

Figure 65. Junction Temperature vs. Total Power Dissipation for the 8-Lead LFCSP, $T_A = 85^\circ\text{C}$

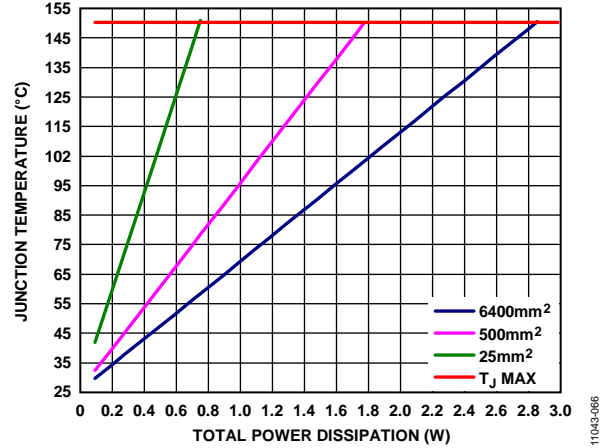

Figure 66. Junction Temperature vs. Total Power Dissipation for the 8-Lead SOIC, $T_A = 25^\circ\text{C}$

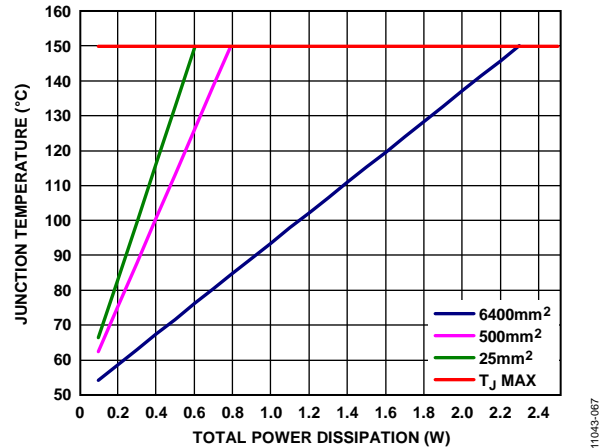

Figure 67. Junction Temperature vs. Total Power Dissipation for the 8-Lead SOIC, $T_A = 50^\circ\text{C}$

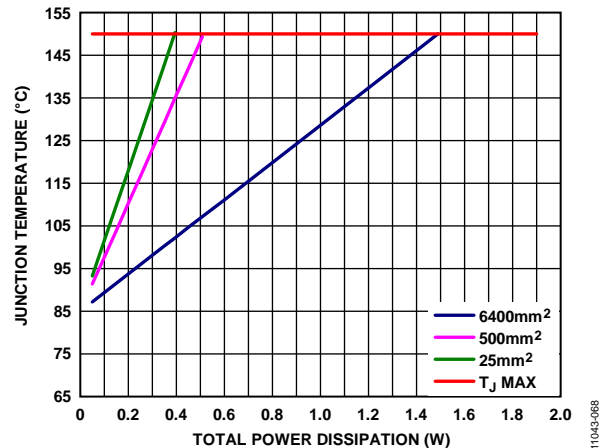

Figure 68. Junction Temperature vs. Total Power Dissipation for the 8-Lead SOIC, $T_A = 85^\circ\text{C}$

Thermal Characterization Parameter (Ψ_{JB})

When board temperature is known, use the thermal characterization parameter, Ψ_{JB} , to estimate the junction temperature rise (see Figure 69 and Figure 70). Maximum junction temperature (T_J) is calculated from the board temperature (T_B) and power dissipation (P_D) using the following formula:

$$T_J = T_B + (P_D \times \Psi_{JB}) \tag{5}$$

The typical value of Ψ_{JB} is 15.1°C/W for the 8-lead LFCSP package and 17.9°C/W for the 8-lead SOIC package.

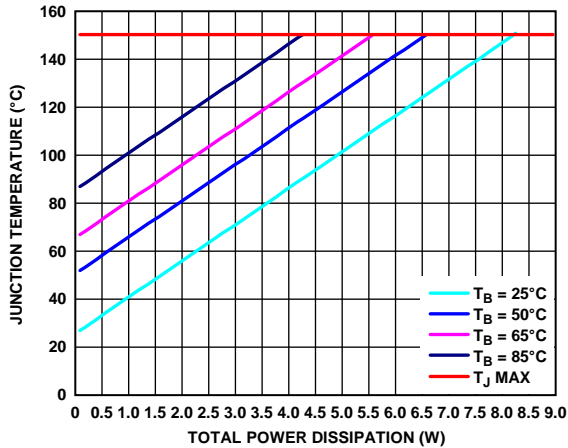

Figure 69. Junction Temperature vs. Total Power Dissipation for the 8-Lead LFCSP

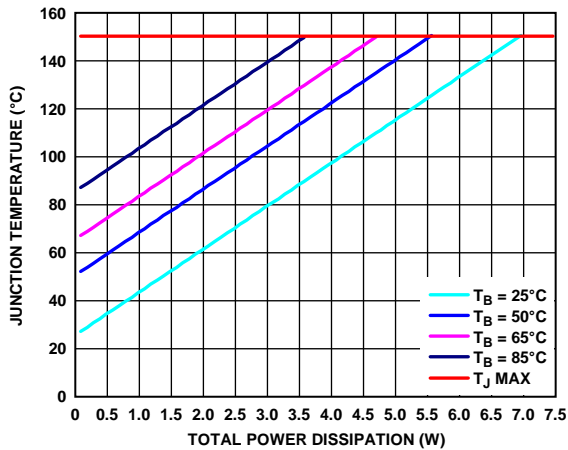

Figure 70. Junction Temperature vs. Total Power Dissipation for the 8-Lead SOIC

PRINTED CIRCUIT BOARD LAYOUT CONSIDERATIONS

Place the input capacitor as close as possible to the VIN and GND pins. Place the output capacitor as close as possible to the VOUT and GND pins. Place the bypass capacitors for V_{REG} , V_{REF} , and V_{BYP} close to the respective pins and GND. Use of an 0805, 0603, or 0402 size capacitor achieves the smallest possible footprint solution on boards where area is limited.

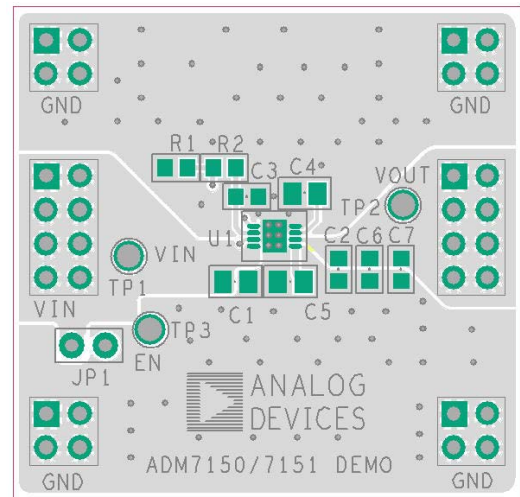

Figure 71. Example 8-Lead LFCSP PCB Layout

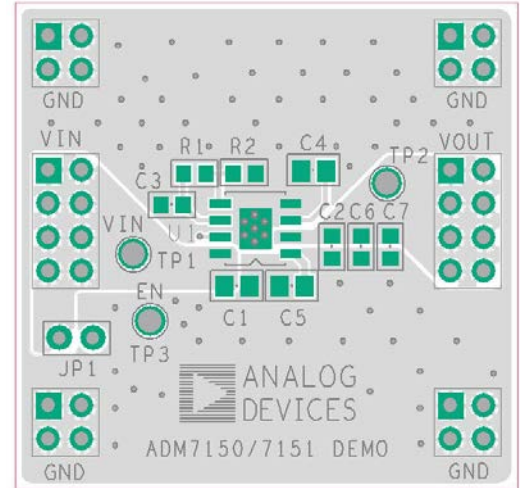
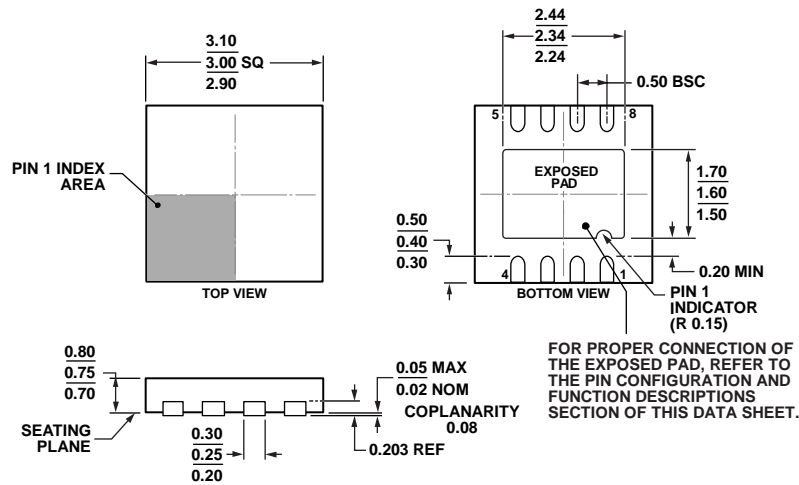

Figure 72. Example 8-Lead SOIC PCB Layout

OUTLINE DIMENSIONS



COMPLIANT TO JEDEC STANDARDS MO-229-WEED

Figure 73. 8-Lead Lead Frame Chip Scale Package [LFCSP_WD]
3 mm x 3 mm Body, Very Very Thin, Dual Lead
(CP-8-11)

Dimensions shown in millimeters

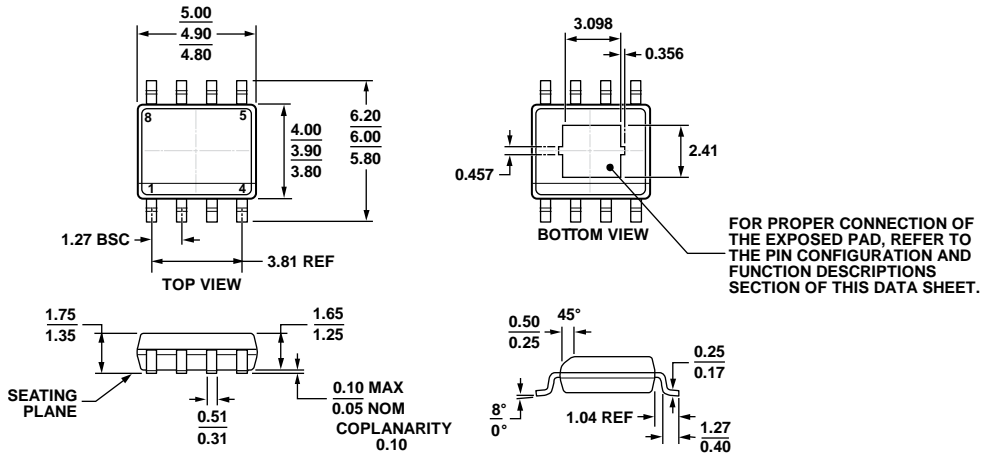

COMPLIANT TO JEDEC STANDARDS MS-012-A-A

Figure 74. 8-Lead Standard Small Outline Package, with Exposed Pad [SOIC_N_EP]
Narrow Body
(RD-8-2)

Dimensions shown in millimeters

ORDERING GUIDE

Model ¹	Temperature Range	Output Voltage	Package Description	Package Option	Branding
ADM7150ACPZ-1.8-R2	-40°C to +125°C	1.8	8-Lead LFCSP_WD	CP-8-11	LP3
ADM7150ACPZ-3.3-R2	-40°C to +125°C	3.3	8-Lead LFCSP_WD	CP-8-11	LNA
ADM7150ACPZ-4.5-R2	-40°C to +125°C	4.5	8-Lead LFCSP_WD	CP-8-11	LNL
ADM7150ACPZ-4.8-R2	-40°C to +125°C	4.8	8-Lead LFCSP_WD	CP-8-11	LNM
ADM7150ACPZ-5.0-R2	-40°C to +125°C	5.0	8-Lead LFCSP_WD	CP-8-11	LNB

Model ¹	Temperature Range	Output Voltage	Package Description	Package Option	Branding
ADM7150ACPZ-1.8-R7	-40°C to +125°C	1.8	8-Lead LFCSP_WD	CP-8-11	LP3
ADM7150ACPZ-3.3-R7	-40°C to +125°C	3.3	8-Lead LFCSP_WD	CP-8-11	LNA
ADM7150ACPZ-4.5-R7	-40°C to +125°C	4.5	8-Lead LFCSP_WD	CP-8-11	LNL
ADM7150ACPZ-4.8-R7	-40°C to +125°C	4.8	8-Lead LFCSP_WD	CP-8-11	LNM
ADM7150ACPZ-5.0-R7	-40°C to +125°C	5.0	8-Lead LFCSP_WD	CP-8-11	LNB
ADM7150ARDZ-1.8	-40°C to +125°C	1.8	8-Lead SOIC_N_EP	RD-8-2	
ADM7150ARDZ-2.8	-40°C to +125°C	2.8	8-Lead SOIC_N_EP	RD-8-2	
ADM7150ARDZ-3.0	-40°C to +125°C	3.0	8-Lead SOIC_N_EP	RD-8-2	
ADM7150ARDZ-3.3	-40°C to +125°C	3.3	8-Lead SOIC_N_EP	RD-8-2	
ADM7150ARDZ-5.0	-40°C to +125°C	5.0	8-Lead SOIC_N_EP	RD-8-2	
ADM7150ARDZ-3.0-R7	-40°C to +125°C	3.0	8-Lead SOIC_N_EP	RD-8-2	
ADM7150ARDZ-3.3-R7	-40°C to +125°C	3.3	8-Lead SOIC_N_EP	RD-8-2	
ADM7150ARDZ-5.0-R7	-40°C to +125°C	5.0	8-Lead SOIC_N_EP	RD-8-2	
ADM7150CP-EVALZ		5.0	Evaluation Board		

¹ Z = RoHS Compliant Part.

NOTES

Looking for pricing, stock, or lifecycle information?

Click below to explore more details on WIN SOURCE:

- ⊖ [View ADM7150ARDZ-3.3-R7 on WIN SOURCE](#)
- ⊖ [Analog Devices Inc. Information](#)

Optimize Your Supply Chain with WIN SOURCE Solutions

- ✓ Global Sourcing Solution
- ✓ Obsolete Management
- ✓ Cost Control Management
- ✓ Shortage Management
- ✓ Alternative Solution
- ✓ Excess Inventory Management