



**THE DATASHEET OF  
AZ7031RTR-G1**



**VOLTAGE DETECTOR**

**AZ70XX**

**General Description**

The AZ70XX series ICs are under voltage detectors with a built in voltage threshold and low power consumption. The AZ70XX are specifically designed to accurately monitor power supplies.

The AZ70XX use a precision on-chip voltage reference and a comparator to measure the input operating voltage. These ICs can accurately reset the system after detecting voltage at the time of switching power on and instantaneous power off in various CPU systems and other logic systems. The detect voltage thresholds are 2.3V/2.5V/2.7V/2.9V/3.1V/3.3V/4.2V/4.5V for AZ7023/25/27/29/31/33/42/45 respectively. Built in hysteresis helps to prevent erratic operation in the presence of noise.

The AZ70XX series are available in 2 standard packages: TO-92 (bulk or ammo packing) and SOT-89.

**Features**

- Low Current Consumption:  
 $I_{CCL}=300\mu A$  Typical  
 $I_{CCH}=30\mu A$  Typical
- Low Minimum Operating Voltage for Output Resetting: 0.8V Typical
- Built in Hysteresis Voltage: 50mV Typical
- Open Collector Output
- Extended Temperature Range: -40 to 85°C

**Applications**

- Low Battery Voltage Detector
- Power Fail Indicator
- Processor Reset Generator
- Battery Backup Control
- Home Electric Appliances

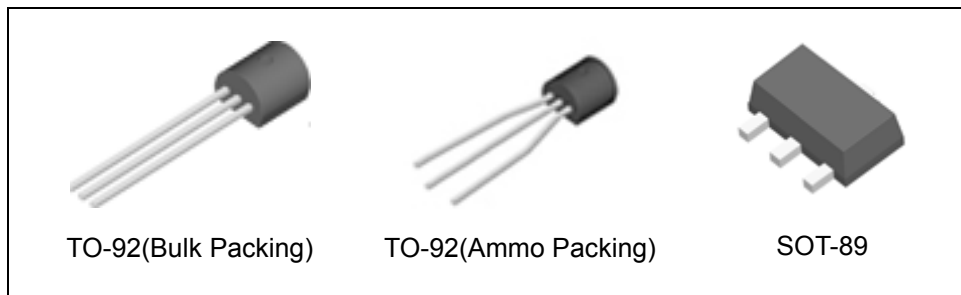

Figure 1. Package Types of AZ70XX

**VOLTAGE DETECTOR**

**AZ70XX**

**Pin Configuration**

Z Package  
(TO-92(Bulk Packing))

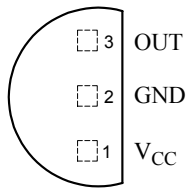

Z Package  
(TO-92(Ammo Packing))

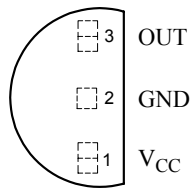

R Package  
(SOT-89)

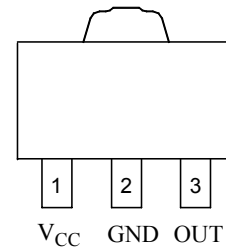

Figure 2. Pin Configuration of AZ70XX (Top View)

**Functional Block Diagram**

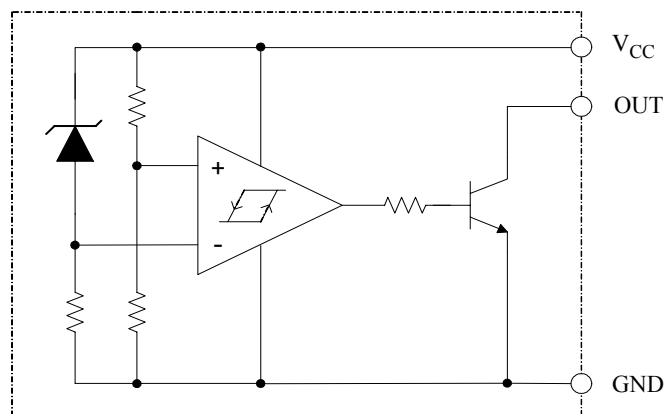

Figure 3. Functional Block Diagram of AZ70XX



**VOLTAGE DETECTOR**

**AZ70XX**

**Ordering Information**

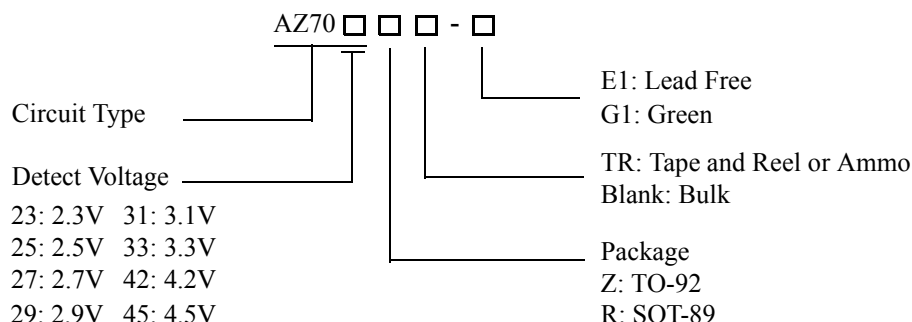

Package	Temperature Range	Detect Voltage	Part Number		Marking ID		Packing Type
			Lead Free	Green	Lead Free	Green	
TO-92	-40 to 85°C	2.3V	AZ7023Z-E1	AZ7023Z-G1	AZ7023Z-E1	AZ7023Z-G1	Bulk
			AZ7023ZTR-E1	AZ7023ZTR-G1	AZ7023Z-E1	AZ7023Z-G1	Ammo
		2.5V	AZ7025Z-E1	AZ7025Z-G1	AZ7025Z-E1	AZ7025Z-G1	Bulk
			AZ7025ZTR-E1	AZ7025ZTR-G1	AZ7025Z-E1	AZ7025Z-G1	Ammo
		2.7V	AZ7027Z-E1	AZ7027Z-G1	AZ7027Z-E1	AZ7027Z-G1	Bulk
			AZ7027ZTR-E1	AZ7027ZTR-G1	AZ7027Z-E1	AZ7027Z-G1	Ammo
		2.9V	AZ7029Z-E1	AZ7029Z-G1	AZ7029Z-E1	AZ7029Z-G1	Bulk
			AZ7029ZTR-E1	AZ7029ZTR-G1	AZ7029Z-E1	AZ7029Z-G1	Ammo
		3.1V	AZ7031Z-E1	AZ7031Z-G1	AZ7031Z-E1	AZ7031Z-G1	Bulk
			AZ7031ZTR-E1	AZ7031ZTR-G1	AZ7031Z-E1	AZ7031Z-G1	Ammo
		3.3V	AZ7033Z-E1	AZ7033Z-G1	AZ7033Z-E1	AZ7033Z-G1	Bulk
			AZ7033ZTR-E1	AZ7033ZTR-G1	AZ7033Z-E1	AZ7033Z-G1	Ammo
		4.2V	AZ7042Z-E1	AZ7042Z-G1	AZ7042Z-E1	AZ7042Z-G1	Bulk
			AZ7042ZTR-E1	AZ7042ZTR-G1	AZ7042Z-E1	AZ7042Z-G1	Ammo
		4.5V	AZ7045Z-E1	AZ7045Z-G1	AZ7045Z-E1	AZ7045Z-G1	Bulk
			AZ7045ZTR-E1	AZ7045ZTR-G1	AZ7045Z-E1	AZ7045Z-G1	Ammo
SOT-89	-40 to 85°C	2.3V	AZ7023RTR-E1	AZ7023RTR-G1	E723	G70A	Tape & Reel
		2.5V	AZ7025RTR-E1	AZ7025RTR-G1	E725	G70G	Tape & Reel
		2.7V	AZ7027RTR-E1	AZ7027RTR-G1	E727	G70B	Tape & Reel
		2.9V	AZ7029RTR-E1	AZ7029RTR-G1	E729	G70C	Tape & Reel
		3.1V	AZ7031RTR-E1	AZ7031RTR-G1	E731	G70H	Tape & Reel
		3.3V	AZ7033RTR-E1	AZ7033RTR-G1	E733	G70D	Tape & Reel
		4.2V	AZ7042RTR-E1	AZ7042RTR-G1	E742	G70E	Tape & Reel
		4.5V	AZ7045RTR-E1	AZ7045RTR-G1	E745	G70F	Tape & Reel

BCD Semiconductor's Pb-free products, as designated with "E1" suffix in the part number, are RoHS compliant. Products with "G1" suffix are available in green packages.

**VOLTAGE DETECTOR****AZ70XX****Absolute Maximum Ratings (Note 1)**

Parameter	Symbol	Value	Unit
Supply Voltage	$V_{CC}$	-0.3 to 20	V
Power Dissipation (Package Limitations, $T_A=25^{\circ}\text{C}$ )	$P_D$	TO-92 Package: 400	mW
		SOT-89 Package: 500	
Operating Junction Temperature	$T_J$	150	$^{\circ}\text{C}$
Storage Temperature Range	$T_{STG}$	-65 to 150	$^{\circ}\text{C}$

Note 1: Stresses greater than those listed under "Absolute Maximum Ratings" may cause permanent damage to the device. These are stress ratings only, and functional operation of the device at these or any other conditions beyond those indicated under "Recommended Operating Conditions" is not implied. Exposure to "Absolute Maximum Ratings" for extended periods may affect device reliability.

**Recommended Operating Conditions**

Parameter	Symbol	Min	Max	Unit
Supply Voltage	$V_{CC}$		18	V
Operating Temperature Range	$T_A$	-40	85	$^{\circ}\text{C}$



**VOLTAGE DETECTOR**

**AZ70XX**

**Electrical Characteristics**

T<sub>A</sub>=25°C, unless otherwise specified.

Parameter	Symbol	Conditions	Min	Typ	Max	Unit	
Detect Voltage	V <sub>DET</sub>	R <sub>L</sub> =200Ω (Note 2)  V <sub>OL</sub> ≤ 0.4V	AZ7023R/Z	2.15	2.3	2.45	V
			AZ7025R/Z	2.35	2.5	2.65	
			AZ7027R/Z	2.55	2.7	2.85	
			AZ7029R/Z	2.75	2.9	3.05	
			AZ7031R/Z	2.95	3.1	3.25	
			AZ7033R/Z	3.15	3.3	3.45	
			AZ7042R/Z	4.05	4.2	4.35	
			AZ7045R/Z	4.35	4.5	4.65	
Low-level Output Voltage	V <sub>OL</sub>	V <sub>CC</sub> =V <sub>DET</sub> (min)-0.05V R <sub>L</sub> =200Ω (Note 2)			0.4	V	
Output Leakage Current	I <sub>OH</sub>	V <sub>CC</sub> =18V			0.1	μA	
Hysteresis Voltage	V <sub>HYS</sub>	R <sub>L</sub> =200Ω (Note 2)	30	50	100	mV	
Detect Voltage Temperature Coefficient	$\frac{\Delta V_{DET}}{V_{DET}} \times \Delta T$	R <sub>L</sub> =200Ω (Note 2)		±0.01		% /°C	
Circuit Current at On Time	I <sub>CCL</sub>	V <sub>CC</sub> =V <sub>DET</sub> (min)-0.05V		300	500	μA	
Circuit Current at Off Time	I <sub>CCH</sub>	V <sub>CC</sub> =5.25V		30	50	μA	
Minimum Operating Voltage	V <sub>OPR</sub>	R <sub>L</sub> =200Ω (Note 2) V <sub>OL</sub> ≤ 0.4V		0.8		V	
“L” Transmission Delay Time	tpHL	V <sub>CC</sub> changed from 5.25V to V <sub>DET</sub> (min)-0.05V, R <sub>L</sub> =1.0KΩ, C <sub>L</sub> =100p (Note 3)		10		μs	
“H” Transmission Delay Time	tpLH	V <sub>CC</sub> changed from V <sub>DET</sub> (min)-0.05V to 5.25V, R <sub>L</sub> =1.0KΩ, C <sub>L</sub> =100p (Note 3)		15		μs	
Output Current at On Time	I <sub>OL I</sub>	V <sub>CC</sub> =V <sub>DET</sub> (min)-0.05V T <sub>A</sub> =25°C (Note 4)	20			mA	
	I <sub>OL II</sub>	V <sub>CC</sub> =V <sub>DET</sub> (min)-0.05V T <sub>A</sub> =-40 to 85 °C (Note 4)	16				
Thermal Resistance (Junction to Case)	θ <sub>JC</sub>	TO-92		72		°C/W	
		SOT-89		74			

Note 2: See test circuit 1 and Figure 12.

Note 3: See test circuit 2 and Figure 12.

Note 4: See test circuit 3. Adjusting the regulative power source until the reading value of voltage meter V is 0.4V, the reading value of current meter A is defined as "Output Current at On Time".

**VOLTAGE DETECTOR**

**AZ70XX**

**Electrical Characteristics (Continued)**



Figure 4. Test Circuit 1



Figure 5. Test Circuit 2



Figure 6. Test Circuit 3



**VOLTAGE DETECTOR**

**AZ70XX**

**Typical Performance Characteristics**

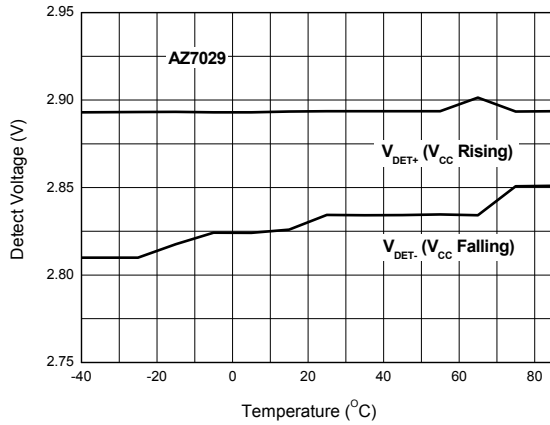

Figure 7. Detect Voltage vs. Temperature

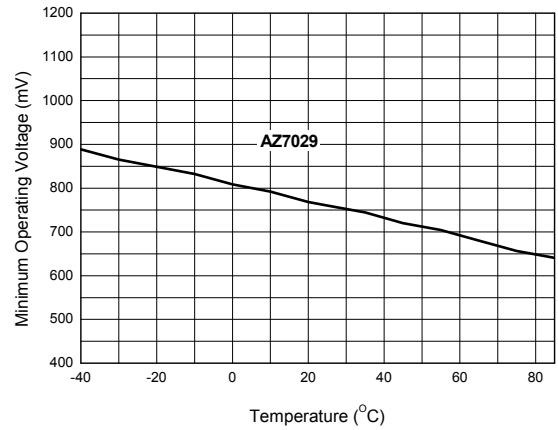

Figure 8. Minimum Operating Voltage vs. Temperature



Figure 9. Output Current at On Time vs. Temperature

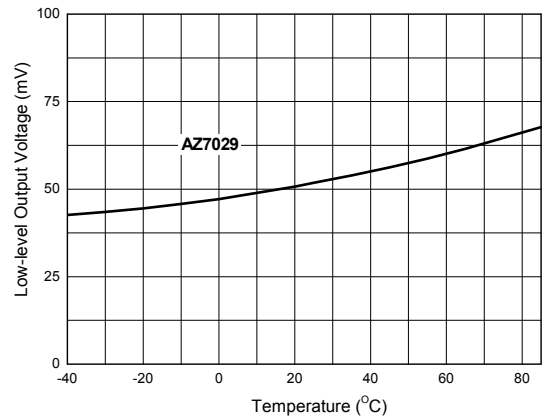

Figure 10. Low-level Output Voltage vs. Temperature

**Typical Performance Characteristics (Continued)**

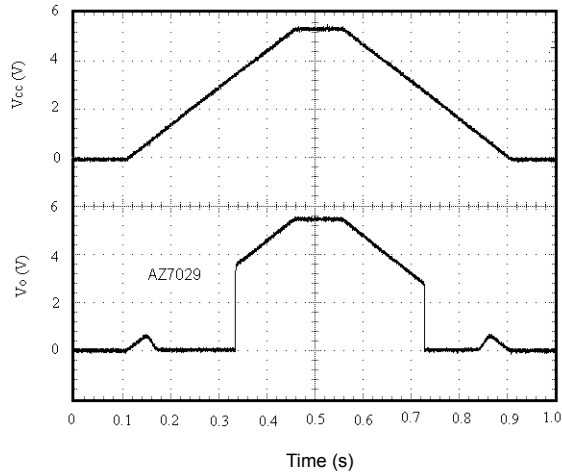

Figure 11. Output Voltage Dynamic Response when  $V_{CC}$  Increases and Decreases

**Operating Diagram**



Figure 12. AZ70XX Timing Waveform (Note 5)

Note 5: Detect voltage:  $V_{DET-}$

Hysteresis voltage ( $V_{HYS}$ ):  $V_{DET+} - V_{DET-}$

Release voltage:  $V_{DET+}$

Minimum operating voltage:  $V_{OPR}$

**VOLTAGE DETECTOR**

**AZ70XX**

**Operating Diagram (Continued)**

Figure 12 is a typical timing waveform for AZ70XX. In normal steady-state operation when  $V_{CC} > V_{DET-}$ , the output will be in a logic high state and  $V_{OUT}$  is dependent upon the voltage that the pull-up resistor connected to.

Here is some explanations for AZ70XX's operation.

1. When the input voltage  $V_{CC}$  falls below  $V_{DET-}$ , the output will pull down to logic low after a delay time of  $t_{pHL}$ . In general, at rated output current and  $V_{CC}$ ,  $V_{OUT}$  can be pulled down to a voltage as low as within 0.4V from GND. (See the Electrical Characteristics section). The voltage level  $V_{DET-}$  means the detect voltage.

2. The output,  $V_{OUT}$ , will stay valid until  $V_{CC}$  falls below the minimum operating voltage,  $V_{OPR}$  (0.8V

typical). Below minimum operating voltage, the output is undefined.

3. During power-up,  $V_{OUT}$  will remain undefined until  $V_{CC}$  rises above  $V_{OPR}$ , at which time the output will become valid.  $V_{OUT}$  will be in its active low state while  $V_{OPR} < V_{CC} < V_{DET+}$  ( $V_{DET+} = V_{DET-} + V_{HYS}$ ).  $V_{DET+}$  is the release voltage.  $V_{HYS}$  means the hysteresis voltage and is the difference voltage between the  $V_{DET+}$  and  $V_{DET-}$ .

4. When  $V_{CC}$  rises above  $V_{DET+}$ , the output will be in its inactive state. After a delay time of  $t_{pLH}$ ,  $V_{OUT}$  will be in its logic high state .

**Typical Applications**



Figure 13. Low Voltage Indicator

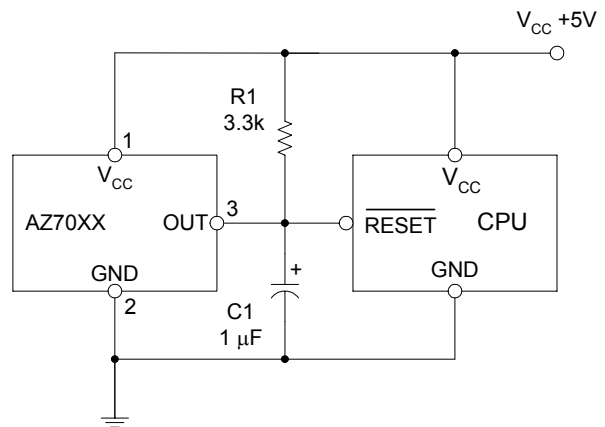

Figure 14. CPU Resetting Circuit



**VOLTAGE DETECTOR**

**AZ70XX**

**Mechanical Dimensions**

**TO-92(Bulk Packing)**

**Unit: mm(inch)**

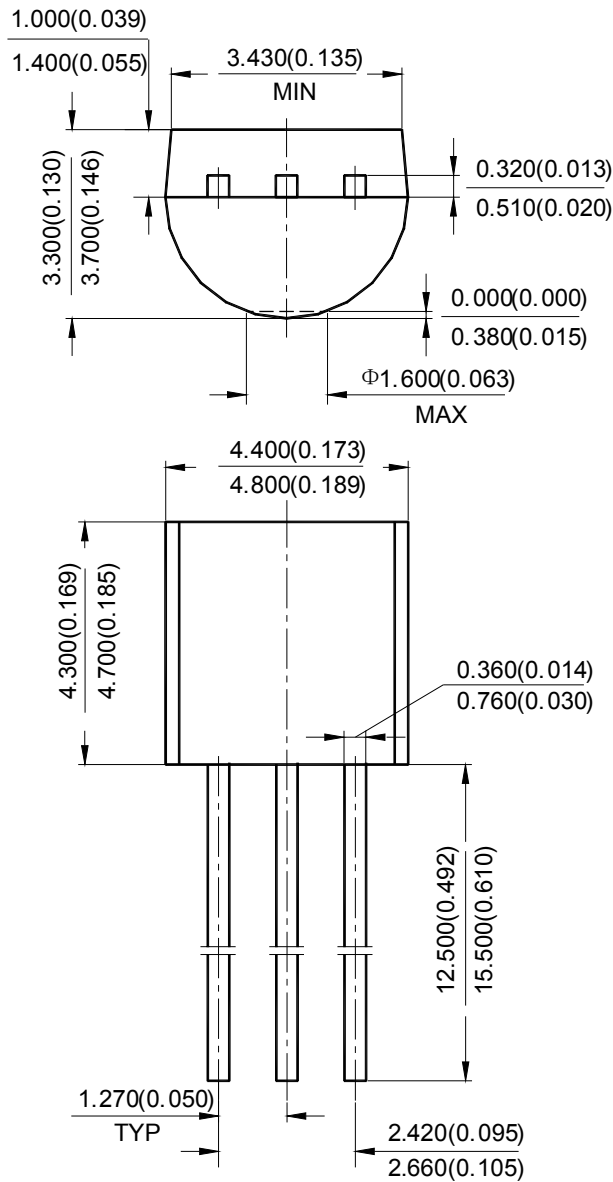



**VOLTAGE DETECTOR**

**AZ70XX**

**Mechanical Dimensions (Continued)**

**TO-92(Ammo Packing)**

**Unit: mm(inch)**





**VOLTAGE DETECTOR**

**AZ70XX**

**Mechanical Dimensions (Continued)**

**SOT-89**

**Unit: mm(inch)**

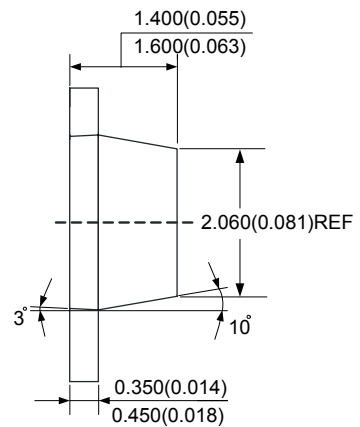
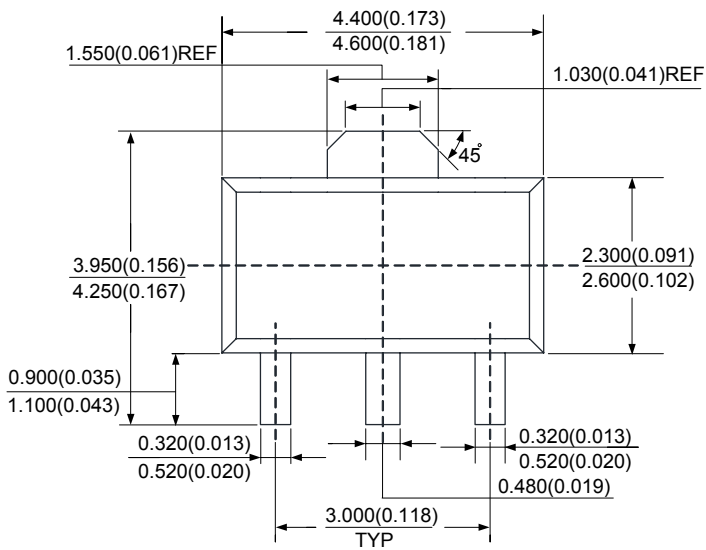



## **BCD Semiconductor Manufacturing Limited**

<http://www.bcdsemi.com>

### **IMPORTANT NOTICE**

BCD Semiconductor Manufacturing Limited reserves the right to make changes without further notice to any products or specifications herein. BCD Semiconductor Manufacturing Limited does not assume any responsibility for use of any its products for any particular purpose, nor does BCD Semiconductor Manufacturing Limited assume any liability arising out of the application or use of any its products or circuits. BCD Semiconductor Manufacturing Limited does not convey any license under its patent rights or other rights nor the rights of others.

---

#### **MAIN SITE**

##### **- Headquarters**

##### **BCD Semiconductor Manufacturing Limited**

No. 1600, Zi Xing Road, Shanghai ZiZhu Science-based Industrial Park, 200241, China  
Tel: +86-21-24162266, Fax: +86-21-24162277

##### **- Wafer Fab**

##### **Shanghai SIM-BCD Semiconductor Manufacturing Co., Ltd.**

800 Yi Shan Road, Shanghai 200233, China  
Tel: +86-21-6485 1491, Fax: +86-21-5450 0008

#### **REGIONAL SALES OFFICE**

##### **Shenzhen Office**

##### **Shanghai SIM-BCD Semiconductor Manufacturing Co., Ltd., Shenzhen Office**

Unit A Room 1203, Skyworth Bldg., Gaoxin Ave. 1.S., Nanshan District, Shenzhen, China  
Tel: +86-755-8826 7951  
Fax: +86-755-8826 7865

##### **Taiwan Office**

##### **BCD Semiconductor (Taiwan) Company Limited**

4F, 298-1, Rui Guang Road, Nei-Hu District, Taipei, Taiwan  
Tel: +886-2-2656 2808  
Fax: +886-2-2656 2806

##### **USA Office**

##### **BCD Semiconductor Corp.**

30920 Huntwood Ave. Hayward, CA 94544, USA  
Tel : +1-510-324-2988  
Fax: +1-510-324-2788

## Looking for pricing, stock, or lifecycle information?

Click below to explore more details on WIN SOURCE:

-  [View AZ7031RTR-G1 on WIN SOURCE](#)
-  [Diodes Incorporated Information](#)

## Optimize Your Supply Chain with WIN SOURCE Solutions

-  Global Sourcing Solution
-  Obsolete Management
-  Cost Control Management
-  Shortage Management
-  Alternative Solution
-  Excess Inventory Management