



**THE DATASHEET OF  
ADM3311EARSZ-REEL7**



## FEATURES

- Green Idle power-saving mode
- Single 2.7 V to 3.6 V power supply
- Operates with 3 V logic
- 0.1  $\mu$ F to 1  $\mu$ F charge pump capacitors
- Low EMI
- Low power shutdown: 20 nA
- Full RS-232 compliance
- 460 kb/s data rate
- One receiver active in shutdown  
(ADM3307E/ADM3311E/ADM3312E/ADM3315E)
- Two receivers active in shutdown (ADM3310E)
- ESD >15 kV IEC 1000-4-2 on RS-232 I/Os
- ESD >15 kV IEC 1000-4-2 on CMOS and RS-232 I/Os  
(ADM3307E)
- Qualified for automotive applications

## APPLICATIONS

- Mobile phone handsets/data cables
- Laptop and notebook computers
- Printers
- Peripherals
- Modems
- PDA's/Hand-Held Devices/Palmtop Computers

## FUNCTIONAL BLOCK DIAGRAMS



<sup>1</sup>INTERNAL 400k $\Omega$  PULL-UP RESISTOR ON EACH CMOS INPUT.  
<sup>2</sup>INTERNAL 5k $\Omega$  PULL-DOWN RESISTOR ON EACH RS-232 INPUT.

Figure 1. ADM3307E Functional Block Diagram

02915-001



<sup>1</sup>INTERNAL 400k $\Omega$  PULL-UP RESISTOR ON EACH CMOS INPUT.  
<sup>2</sup>INTERNAL 5k $\Omega$  PULL-DOWN RESISTOR ON EACH RS-232 INPUT.

Figure 2. ADM3310E/ADM3311E Functional Block Diagram

02915-002

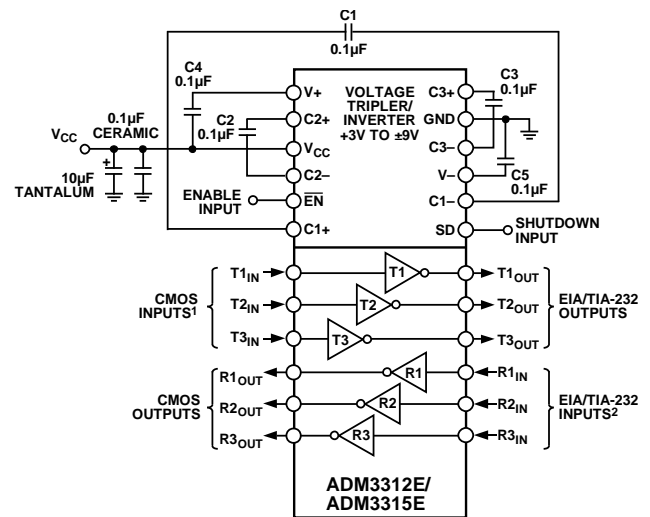

<sup>1</sup>INTERNAL 400k $\Omega$  PULL-UP RESISTOR ON EACH CMOS INPUT.  
<sup>2</sup>INTERNAL 5k $\Omega$  (22k $\Omega$  FOR ADM3315E) PULL-DOWN RESISTOR ON EACH RS-232 INPUT.

Figure 3. ADM3312E/ADM3315E Functional Block Diagram

02915-003

<sup>1</sup> Protected by U.S. Patent No. 5,606,491.

### Rev. J

### Document Feedback

Information furnished by Analog Devices is believed to be accurate and reliable. However, no responsibility is assumed by Analog Devices for its use, nor for any infringements of patents or other rights of third parties that may result from its use. Specifications subject to change without notice. No license is granted by implication or otherwise under any patent or patent rights of Analog Devices. Trademarks and registered trademarks are the property of their respective owners.

## TABLE OF CONTENTS

|  |   |   |    |
|--|---|---|----|
| Features .....                                     | 1 | Typical Performance Characteristics ..... | 10 |
| Applications.....                                  | 1 | Circuit Description.....                  | 13 |
| Functional Block Diagrams.....                     | 1 | Enable and Shutdown .....                 | 15 |
| Revision History .....                             | 2 | Layout and Supply Decoupling .....        | 15 |
| General Description .....                          | 3 | ESD/EFT Transient Protection Scheme ..... | 15 |
| Specifications.....                                | 4 | ESD Testing (IEC 1000-4-2) .....          | 16 |
| Absolute Maximum Ratings.....                      | 6 | Outline Dimensions .....                  | 18 |
| ESD Caution.....                                   | 6 | Ordering Guide .....                      | 20 |
| Product Selection Guide.....                       | 7 | Automotive Products.....                  | 20 |
| Pin Configurations and Function Descriptions ..... | 8 |   |    |

## REVISION HISTORY

### 6/15—Rev. I to Rev. J

|  |            |
|--|------------|
| Changed ADM33xxE to ADM3307E/ADM3310E/ADM3311E/<br>ADM3312E/ADM3315E ..... | Throughout |
| Changes to ESD Testing (IEC 1000-4-2) Section .....                        | 16         |
| Changes to Figure 34.....  | 17         |
| Changes to Ordering Guide .....  | 20         |

### 3/13—Rev. H to Rev. I

|  |    |
|--|----|
| Changed CP-32-2 Package to CP-32-7 Package, Throughout.... | 1  |
| Changes to Figure 4, Figure 6, Figure 8 .....              | 8  |
| Changes to Figure 25.....                                  | 13 |
| Updated Outline Dimensions .....                           | 18 |
| Changes to Ordering Guide .....                            | 20 |
| Added Automotive Products Section.....                     | 20 |

### 1/06—Rev. G to Rev. H

|                                 |           |
|---------------------------------|-----------|
| Updated Formatting.....         | Universal |
| Updated Outline Dimensions..... | 18        |
| Changes to Ordering Guide.....  | 20        |

### 4/04—Rev. F to Rev. G

|                                 |    |
|---------------------------------|----|
| Changes to Ordering Guide.....  | 5  |
| Updated Outline Dimensions..... | 15 |

### 8/02—Rev. E to Rev. F

|   |           |
|---|-----------|
| ADM3307E (REV. 0), ADM3311E (REV. E), and ADM3312E<br>(REV. A) Data Sheets Merged into REV. G of ADM33xxE Universal<br>ADM3310E (REV. PrA Now Prelims) and ADM3315E<br>(REV. PrA) Added ..... | Universal |
| Edits to Features.....  | 1         |
| Edits to Applications .....   | 1         |

|  |    |
|--|----|
| Edits to General Description.....  | 1  |
| Edits to Functional Block Diagrams .....                                     | 2  |
| Edits to Specifications .....  |    |
| Edits to Absolute Maximum Ratings .....                                      | 4  |
| ADM33xx Product Selection Guide Added.....                                   | 5  |
| Added ADM3307E, ADM3310E, ADM3312E, and<br>ADM3315E Pin Configurations ..... | 6  |
| Edits to Pin Function Descriptions .....                                     | 7  |
| Added ADM3307E, ADM3310E, ADM3312E, and<br>ADM3315E Truth Tables .....       | 7  |
| Edits to TPCs 1–14 .....   | 8  |
| TPCs 15–18 Deleted.....  | 10 |
| Edits to Circuit Description Section .....                                   | 11 |
| Edits to Charge Pump DC-to-DC Voltage Converter Section.....                 | 11 |
| Edits to How Does It Work Section .....                                      | 11 |
| Edits to Green Idle vs. Shutdown Section .....                               | 12 |
| Edits to Doesn't It Increase Supply Voltage Ripple? Section.....             | 12 |
| Edits to What About Electromagnetic Compatibility? Section.....              | 12 |
| Edits to Transmitter (Driver) Section .....                                  | 12 |
| Edits to Receiver Section .....  | 12 |
| Edits to Enable and Shutdown Section .....                                   | 12 |
| Edits to High Baud Rate Section.....   | 13 |
| Edits to ESD/EFT Transient Protection Scheme .....                           | 13 |
| Added Figures 8a and 8b and Renumbered the Figures<br>that Followed .....    | 13 |
| Edits to ESD Testing (IEC 1000-4-2) Section .....                            | 14 |
| Edits to Figure 9 .....  | 14 |
| Deleted Table II and Table III and replaced them with Table V .....          | 14 |
| Added RU-24 Package Outline Updated CP-32, RS-28<br>and RU-28.....           | 15 |

## GENERAL DESCRIPTION

The [ADM3307E/ADM3310E/ADM3311E/ADM3312E/ADM3315E](#) line of driver/receiver products is designed to fully meet the EIA-232 standard while operating with a single 2.7 V to 3.6 V power supply. The devices feature an on-board charge pump dc-to-dc converter, eliminating the need for dual power supplies. This dc-to-dc converter contains a voltage tripler and a voltage inverter that internally generates positive and negative supplies from the input 3 V power supply. The dc-to-dc converter operates in Green Idle™ mode, whereby the charge pump oscillator is gated on and off to maintain the output voltage at  $\pm 7.25$  V under varying load conditions. This minimizes the power consumption and makes these products ideal for battery-powered portable devices.

The [ADM3307E/ADM3310E/ADM3311E/ADM3312E/ADM3315E](#) devices are suitable for operation in harsh electrical environments and contain ESD protection up to  $\pm 15$  kV on their RS-232 lines ([ADM3310E](#), [ADM3311E](#), [ADM3312E](#), and [ADM3315E](#)). The [ADM3307E](#) contains ESD protection up to  $\pm 15$  kV on all I/O lines (CMOS, RS-232,  $\overline{\text{EN}}$ , and SD).

A shutdown facility that reduces the power consumption to 66 nW is also provided. While in shutdown, one receiver remains active (two receivers active with [ADM3310E](#)), thereby allowing monitoring of peripheral devices. This feature allows the device to be shut down until a peripheral device begins communication.

The active receiver can alert the processor, which can then take the [ADM3307E/ADM3310E/ADM3311E/ADM3312E/ADM3315E](#) device out of the shutdown mode.

The [ADM3307E](#) contains five drivers and three receivers and is intended for mobile phone data lump cables and portable computing applications.

The [ADM3311E](#) contains three drivers and five receivers and is intended for serial port applications on notebook/laptop computers.

The [ADM3310E](#) is a low current version of the [ADM3311E](#). This device also allows two receivers to be active in shutdown mode.

The [ADM3312E](#) contains three drivers and three receivers and is intended for serial port applications, PDAs, mobile phone data lump cables, and other hand-held devices.

The [ADM3315E](#) is a low current version of the [ADM3312E](#), with a 22 k $\Omega$  receiver input resistance that reduces the drive requirements of the DTE. Its main applications are PDAs, palmtop computers, and mobile phone data lump cables.

The [ADM3307E/ADM3310E/ADM3311E/ADM3312E/ADM3315E](#) devices are fabricated using CMOS technology for minimal power consumption. All parts feature a high level of overvoltage protection and latch-up immunity.

All [ADM3307E/ADM3310E/ADM3311E/ADM3312E/ADM3315E](#) devices are available in a 32-lead 5 mm  $\times$  5 mm LFCSP\_WQ and in a TSSOP ([ADM3307E](#), [ADM3310E](#), and [ADM3311E](#) in a 28-lead TSSOP; [ADM3312E](#) and [ADM3315E](#) in a 24-lead TSSOP). The [ADM3311E](#) also comes in a 28-lead SSOP.

The [ADM3307E/ADM3310E/ADM3311E/ADM3312E/ADM3315E](#) devices are ruggedized RS-232 line drivers/receivers that operate from a single supply of 2.7 V to 3.6 V. Step-up voltage converters coupled with level shifting transmitters and receivers allow RS-232 levels to be developed while operating from a single supply. Features include low power consumption, Green Idle operation, high transmission rates, and compatibility with the EU directive on electromagnetic compatibility. This EM compatibility directive includes protection against radiated and conducted interference, including high levels of electrostatic discharge.

All RS-232 (and CMOS, SD, and  $\overline{\text{EN}}$  for [ADM3307E](#)) inputs and outputs are protected against electrostatic discharges (up to  $\pm 15$  kV). This ensures compliance with IEC 1000-4-2 requirements.

These devices are ideally suited for operation in electrically harsh environments or where RS-232 cables are frequently being plugged/unplugged. They are also immune to high RF field strengths without special shielding precautions.

Emissions are also controlled to within very strict limits. CMOS technology is used to keep the power dissipation to an absolute minimum, allowing maximum battery life in portable applications.

## SPECIFICATIONS

$V_{CC} = 2.7\text{ V to }3.6\text{ V}$ ,  $C1\text{ to }C5 = 0.1\text{ }\mu\text{F}$ . All specifications  $T_{MIN}$  to  $T_{MAX}$ , unless otherwise noted.

Table 1

| Parameter                                     | Min            | Typ       | Max       | Unit          | Test Conditions/Comments  |
|---|----------------|-----------|-----------|---------------|---|
| Operating Voltage Range                       | 2.7            | 3.3       | 3.6       | V             |   |
| $V_{CC}$ Power Supply Current                 |                |           |           |               |   |
| ADM3307E                                      |                | 0.75      | 1.5       | mA            | $V_{CC} = 3.0\text{ V to }3.6\text{ V}$ ; no load   |
| ADM3311E, ADM3312E                            |                | 0.75      | 4.5       | mA            | $V_{CC} = 2.7\text{ V to }3.6\text{ V}$ ; no load   |
| ADM3310E, ADM3315E                            |                | 0.45      | 1         | mA            | No load; $V_{CC} = 3.0\text{ V to }3.6\text{ V}$ ; $T_A = 0^\circ\text{C to }85^\circ\text{C}$    |
| ADM3310E, ADM3311E, ADM3312E, ADM3315E        |                | 0.45      | 4.5       | mA            | No load; $V_{CC} = 2.7\text{ V to }3.6\text{ V}$ ; $T_A = -40^\circ\text{C to }+85^\circ\text{C}$ |
| ADM3310E, ADM3315E                            |                | 0.35      | 0.85      | mA            | $V_{CC} = 2.7\text{ V to }3.6\text{ V}$ ; no load   |
| ADM3310E, ADM3311E, ADM3312E, ADM3315E        |                |           | 35        | mA            | $R_L = 3\text{ k}\Omega$ to GND on all $T_{OUTS}$   |
| Shutdown Supply Current                       |                | 0.02      | 1         | $\mu\text{A}$ |   |
| Input Pull-Up Current                         |                | 10        | 25        | $\mu\text{A}$ | $T_{IN} = \text{GND}$   |
| Input Leakage Current, $\overline{\text{EN}}$ |                | 0.02      | $\pm 1$   | $\mu\text{A}$ |   |
| Input Logic Threshold Low, $V_{INL}$          |                |           | 0.8       | V             | $T_{IN}, \overline{\text{EN}}, \text{SHDN}$   |
| Input Logic Threshold High, $V_{INH}$         | 2.0            |           | 0.4       | V             | $T_{IN}, \overline{\text{EN}}, \text{SHDN}; V_{CC} = 2.7\text{ V}$                                |
| CMOS Output Voltage Low, $V_{OL}$             |                |           | 0.4       | V             | $T_{IN}, \overline{\text{EN}}, \text{SHDN}$   |
| CMOS Output Voltage High, $V_{OH}$            | $V_{CC} - 0.6$ |           |           | V             | $I_{OUT} = 1.6\text{ mA}$   |
| CMOS Output Leakage Current                   |                |           |           |               | $I_{OUT} = -200\text{ }\mu\text{A}$   |
| ADM3307E                                      |                | 0.04      | $\pm 1$   | $\mu\text{A}$ | $\overline{\text{EN}} = V_{CC}, 0\text{ V} < R_{OUT} < V_{CC}$                                    |
| ADM3310E, ADM3311E                            |                | 0.05      | $\pm 5$   | $\mu\text{A}$ | $\overline{\text{EN}} = V_{CC}, 0\text{ V} < R_{OUT} < V_{CC}$                                    |
| ADM3312E, ADM3315E                            |                |           |           |               |   |
| Charge Pump Output Voltage, $V+$              |                | +7.25     |           | V             | No load   |
| ADM3307E, ADM3311E, ADM3312E                  |                |           |           |               |   |
| Charge Pump Output Voltage, $V-$              |                | -7.25     |           | V             | No load   |
| ADM3307E, ADM3311E, ADM3312E                  |                |           |           |               |   |
| Charge Pump Output Voltage, $V+$              |                | +6.5      |           | V             | No load   |
| ADM3310E, ADM3315E                            |                |           |           |               |   |
| Charge Pump Output Voltage, $V-$              |                | -6.5      |           | V             | No load   |
| ADM3310E, ADM3315E                            |                |           |           |               |   |
| EIA-232 Input Voltage Range                   | -25            |           | +25       | V             |   |
| EIA-232 Input Threshold Low                   | 0.4            | 1.3       |           | V             |   |
| EIA-232 Input Threshold High                  |                | 2.0       | 2.4       | V             |   |
| EIA-232 Input Hysteresis                      |                | 0.14      |           | V             |   |
| EIA-232 Input Resistance                      |                |           |           |               |   |
| ADM3307E, ADM3310E, ADM3311E, ADM3312E        | 3              | 5         | 7         | k $\Omega$    |   |
| ADM3315E                                      | 14             | 22        | 31        | k $\Omega$    |   |
| Output Voltage Swing                          |                |           |           |               |   |
| ADM3310E, ADM3315E                            |                | $\pm 5.0$ | $\pm 5.5$ | V             | All transmitter outputs loaded with $3\text{ k}\Omega$ to ground                                  |
| ADM3307E, ADM3311E, ADM3312E                  | $\pm 5.0$      | $\pm 6.4$ |           | V             | $V_{CC} = 3.0\text{ V}$   |
|   |                | $\pm 5.5$ |           | V             | $V_{CC} = 2.7\text{ V}$   |
|   |                |           |           |               | All transmitter outputs loaded with $3\text{ k}\Omega$ to ground                                  |
| Transmitter Output Resistance                 | 300            |           |           | $\Omega$      | $V_{CC} = 0\text{ V}, V_{OUT} = \pm 2\text{ V}$   |
| RS-232 Output Short-Circuit Current           |                | $\pm 15$  | $\pm 60$  | mA            |   |

| Parameter  | Min | Typ      | Max | Unit             | Test Conditions/Comments  |
|--|-----|----------|-----|------------------|---|
| Maximum Data Rate                                    |     |          |     |                  |   |
| ADM3307E   | 250 | 720      |     | kbps             | $R_L = 3\text{ k}\Omega$ to $7\text{ k}\Omega$ , $C_L = 50\text{ pF}$ to $1000\text{ pF}$ , $V_{CC} = 2.7\text{ V}$ |
|  | 460 | 920      |     | kbps             | $R_L = 3\text{ k}\Omega$ to $7\text{ k}\Omega$ , $C_L = 50\text{ pF}$ to $1000\text{ pF}$ , $V_{CC} = 3.0\text{ V}$ |
| ADM3310E, ADM3311E, ADM3312E,<br>ADM3315E            | 250 | 460      |     | kbps             | $R_L = 3\text{ k}\Omega$ to $7\text{ k}\Omega$ , $C_L = 50\text{ pF}$ to $1000\text{ pF}$ , $V_{CC} = 3.0\text{ V}$ |
| Receiver Propagation Delay, $T_{PHL}$ , $T_{PLH}$    |     | 0.3      |     | $\mu\text{s}$    | $C_L = 150\text{ pF}$   |
|  |     | 0.17     | 1   | $\mu\text{s}$    | $C_L = 150\text{ pF}$ ; ADM3307E only   |
| Receiver Output Enable Time, $t_{ER}$                |     | 100      |     | ns               |   |
| Receiver Output Disable Time, $t_{DR}$               |     | 300      |     | ns               |   |
| Transmitter Propagation Delay, $T_{PHL}$ , $T_{PLH}$ |     | 500      |     | ns               | $R_L = 3\text{ k}\Omega$ , $C_L = 1000\text{ pF}$   |
| Transition Region Slew Rate                          | 3   | 18       |     | V/ $\mu\text{s}$ | $R_L = 3\text{ k}\Omega$ , $C_L = 50\text{ pF}$ to $1000\text{ pF}$ <sup>1</sup>                                    |
| ESD PROTECTION (I/O PINS)                            |     | $\pm 15$ |     | kV               | Human body model  |
|  |     | $\pm 15$ |     | kV               | IEC 1000-4-2 air discharge  |
|  |     | $\pm 8$  |     | kV               | IEC 1000-4-2 contact discharge <sup>2</sup>   |

<sup>1</sup> Measured at +3 V to -3 V or -3 V to +3 V.

<sup>2</sup> Includes CMOS I/O, SD, and  $\overline{\text{EN}}$  for ADM3307E.

## ABSOLUTE MAXIMUM RATINGS

$T_A = 25^\circ\text{C}$ , unless otherwise noted.

**Table 2**

| Parameter  | Rating                              |
|--|-------------------------------------|
| $V_{CC}$   | -0.3 V to +4 V                      |
| V+   | $(V_{CC} - 0.3\text{ V})$ to +9 V   |
| V-   | +0.3 V to -9 V                      |
| Input Voltages                                     |                                     |
| $T_{IN}$   | -0.3 V to +6 V                      |
| $R_{IN}$   | $\pm 30\text{ V}$                   |
| Output Voltages                                    |                                     |
| $T_{OUT}$  | $\pm 15\text{ V}$                   |
| $R_{OUT}$  | -0.3 V to $(V_{CC} + 0.3\text{ V})$ |
| Short-Circuit Duration                             |                                     |
| $T_{OUT}$  | Continuous                          |
| Thermal Impedance, $\theta_{JA}$                   |                                     |
| LFCSP_WQ (CP-32-7)                                 | 32.5°C/W                            |
| TSSOP (RU-28)                                      | 68.0°C/W                            |
| TSSOP (RU-24)                                      | 68.0°C/W                            |
| SSOP (RS-28)                                       | 76.0°C/W                            |
| Operating Temperature Range                        |                                     |
| Industrial (A Version)                             | -40°C to +85°C                      |
| Storage Temperature Range                          | -65°C to +150°C                     |
| Lead Temperature (Soldering, 10 sec)               | 300°C                               |
| ESD Rating (IEC 1000-4-2 Air)<br>(RS-232 I/Os)     | $\pm 15\text{ kV}$                  |
| ESD Rating (IEC 1000-4-2 Contact)<br>(RS-232 I/Os) | $\pm 8\text{ kV}$                   |

Stresses at or above those listed under Absolute Maximum Ratings may cause permanent damage to the product. This is a stress rating only; functional operation of the product at these or any other conditions above those indicated in the operational section of this specification is not implied. Operation beyond the maximum operating conditions for extended periods may affect product reliability.

### ESD CAUTION



**ESD (electrostatic discharge) sensitive device.** Charged devices and circuit boards can discharge without detection. Although this product features patented or proprietary protection circuitry, damage may occur on devices subjected to high energy ESD. Therefore, proper ESD precautions should be taken to avoid performance degradation or loss of functionality.

## PRODUCT SELECTION GUIDE

Table 3. Product Selection Guide

| Generic                  | Supply Voltage | Tx | Rx | No. Rx Active in SD | Speed    | 15 kV ESD                                    | I <sub>cc</sub> Max | I <sub>cc</sub> Shutdown Max <sup>1</sup> | Additional Features  |
|--------------------------|----------------|----|----|---------------------|----------|--|---------------------|---|--|
| <a href="#">ADM3307E</a> | 2.7 V to 3.6 V | 5  | 3  | 1                   | 1 Mbps   | RS-232 CMOS, $\overline{\text{EN}}$ , and SD | 1.5 mA              | 1 $\mu\text{A}$                           | $\pm 15$ kV ESD protection, CMOS on RS-232, and CMOS I/Os including SD and $\overline{\text{EN}}$ pins<br>2 Rxs active in shutdown, Green Idle mode level 6 V, low power<br><a href="#">ADM3311E</a> |
| <a href="#">ADM3310E</a> | 2.7 V to 3.6 V | 3  | 5  | 2                   | 460 kbps | RS-232                                       | 0.85 mA             | 1 $\mu\text{A}$                           |  |
| <a href="#">ADM3311E</a> | 2.7 V to 3.6 V | 3  | 5  | 1                   | 460 kbps | RS-232                                       | 1 mA                | 1 $\mu\text{A}$                           |  |
| <a href="#">ADM3312E</a> | 2.7 V to 3.6 V | 3  | 3  | 1                   | 460 kbps | RS-232                                       | 1 mA                | 1 $\mu\text{A}$                           |  |
| <a href="#">ADM3315E</a> | 2.7 V to 3.6 V | 3  | 3  | 1                   | 460 kbps | RS-232                                       | 0.85 mA             | 1 $\mu\text{A}$                           |  |
|                          |                |    |    |                     |          |  |                     |   | 22 k $\Omega$ Rx I/P resistance, Green Idle mode level 6 V, low power<br><a href="#">ADM3312E</a>  |

<sup>1</sup> I<sub>cc</sub> shutdown is 20 nA typically.

PIN CONFIGURATIONS AND FUNCTION DESCRIPTIONS



NOTES  
 1. THE EXPOSED PAD IS CONNECTED TO GROUND.  
 2. NC = NO CONNECT. DO NOT CONNECT TO THIS PIN.

02915-004

Figure 4. ADM3307E LFCSP\_WQ Pin Configuration



NOTES  
 1. THE EXPOSED PAD IS CONNECTED TO GROUND.  
 2. NC = NO CONNECT. DO NOT CONNECT TO THIS PIN.

02915-006

Figure 6. LFCSP\_WQ Pin Configuration



NOTES  
 1. THE EXPOSED PAD IS CONNECTED TO GROUND.  
 2. NC = NO CONNECT. DO NOT CONNECT TO THIS PIN.

02915-008

Figure 8. LFCSP\_WQ Pin Configuration

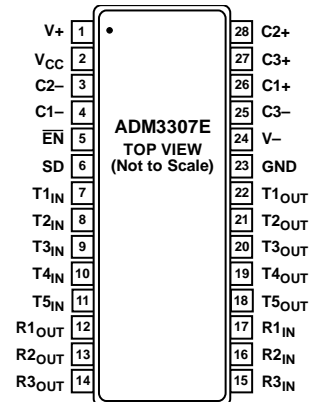

02915-005

Figure 5. SSOP/TSSOP Pin Configuration

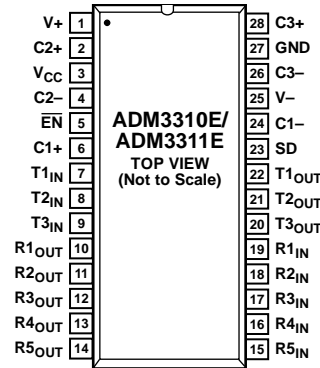

02915-007

Figure 7. SSOP/TSSOP Pin Configuration

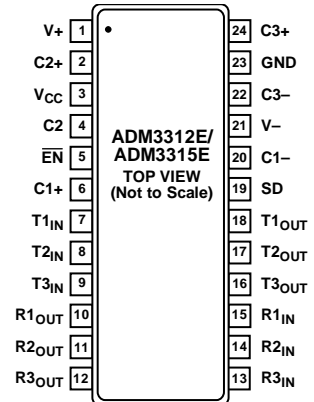

02915-009

Figure 9. SSOP/TSSOP Pin Configuration

Table 4. Pin Function Descriptions

| Mnemonic         | Function   |
|------------------|--|
| V <sub>CC</sub>  | Power Supply Input 2.7 V to 3.6 V.   |
| V+               | Internally Generated Positive Supply, 7.25 V (6.5 V Nominal for ADM3310E, ADM3315E). Capacitor C4 is connected between V <sub>CC</sub> and V+.   |
| V–               | Internally Generated Positive Supply, –7.25 V (–6.5 V Nominal for ADM3310E, ADM3315E). Capacitor C5 is connected between GND and V–.   |
| GND              | Ground Pin. Must be connected to 0 V.  |
| C1+, C1–         | External Capacitor 1 is connected between these pins. A 0.1 μF capacitor is recommended, but larger capacitors up to 1 μF can be used.   |
| C2+, C2–         | External Capacitor 2 is connected between these pins. A 0.1 μF capacitor is recommended, but larger capacitors up to 1 μF can be used.   |
| C3+, C3–         | External Capacitor 3 is connected between these pins. A 0.1 μF capacitor is recommended, but larger capacitors up to 1 μF can be used.   |
| T <sub>IN</sub>  | Transmitter (Driver) Inputs. These inputs accept TTL/CMOS levels. An internal 400 kΩ pull-up resistor to V <sub>CC</sub> is connected on each input.   |
| T <sub>OUT</sub> | Transmitter (Driver) Outputs. Typically ±5.5 V (±6.4 V for ADM3311E and ADM3312E).   |
| R <sub>IN</sub>  | Receiver Inputs. These inputs accept RS-232 signal levels. An internal 5 kΩ pull-down resistor (22 kΩ for ADM3315E) to GND is connected on each of these inputs.   |
| R <sub>OUT</sub> | Receiver Outputs. These are TTL/CMOS levels.   |
| EN               | Receiver Enable. A high level three-states all the receiver outputs.   |
| SD               | Shutdown Control. A high level disables the charge pump and reduces the quiescent current to less than 1 μA. All transmitters and most receivers are disabled. One receiver remains active in shutdown (two receivers are active in shutdown for the ADM3310E).<br>For ADM3307E, R <sub>OUT3</sub> is active in shutdown.<br>For ADM3310E, R <sub>OUT4</sub> and R <sub>OUT5</sub> are active in shutdown.<br>For ADM3311E, R <sub>OUT5</sub> is active in shutdown.<br>For ADM3312E, R <sub>OUT3</sub> is active in shutdown.<br>For ADM3315E, R <sub>OUT3</sub> is active in shutdown. |
| NC               | No Connect.  |

Table 5. ADM3307E Truth Table

| SD | EN | Status           | T <sub>OUT1–5</sub> | R <sub>OUT1–2</sub> | R <sub>OUT3</sub> |
|----|----|------------------|---------------------|---------------------|-------------------|
| 0  | 0  | Normal Operation | Enabled             | Enabled             | Enabled           |
| 0  | 1  | Normal Operation | Enabled             | Disabled            | Disabled          |
| 1  | 0  | Shutdown         | Disabled            | Disabled            | Enabled           |
| 1  | 1  | Shutdown         | Disabled            | Disabled            | Disabled          |

Table 6. ADM3310E Truth Table

| SD | EN | Status             | T <sub>OUT1–3</sub> | R <sub>OUT1–3</sub> | R <sub>OUT4–5</sub> |
|----|----|--------------------|---------------------|---------------------|---------------------|
| 0  | 0  | Normal Operation   | Enabled             | Enabled             | Enabled             |
| 0  | 1  | Receivers Disabled | Enabled             | Disabled            | Disabled            |
| 1  | 0  | Shutdown           | Disabled            | Disabled            | Enabled             |
| 1  | 1  | Shutdown           | Disabled            | Disabled            | Disabled            |

Table 7. ADM3311E Truth Table

| SD | EN | Status             | T <sub>OUT1–3</sub> | R <sub>OUT1–4</sub> | R <sub>OUT5</sub> |
|----|----|--------------------|---------------------|---------------------|-------------------|
| 0  | 0  | Normal Operation   | Enabled             | Enabled             | Enabled           |
| 0  | 1  | Receivers Disabled | Enabled             | Disabled            | Disabled          |
| 1  | 0  | Shutdown           | Disabled            | Disabled            | Enabled           |
| 1  | 1  | Shutdown           | Disabled            | Disabled            | Disabled          |

Table 8. ADM3312E/ADM3315E Truth Table

| SD | EN | Status           | T <sub>OUT1–3</sub> | R <sub>OUT1–2</sub> | R <sub>OUT3</sub> |
|----|----|------------------|---------------------|---------------------|-------------------|
| 0  | 0  | Normal Operation | Enabled             | Enabled             | Enabled           |
| 0  | 1  | Normal Operation | Enabled             | Disabled            | Disabled          |
| 1  | 0  | Shutdown         | Disabled            | Disabled            | Enabled           |
| 1  | 1  | Shutdown         | Disabled            | Disabled            | Disabled          |

TYPICAL PERFORMANCE CHARACTERISTICS



Figure 10. Charge Pump V+ Exiting Shutdown

02915-010

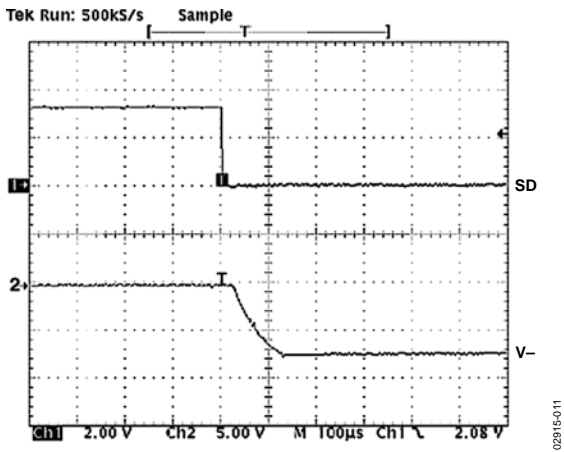

Figure 11. Charge Pump V- Exiting Shutdown

02915-011

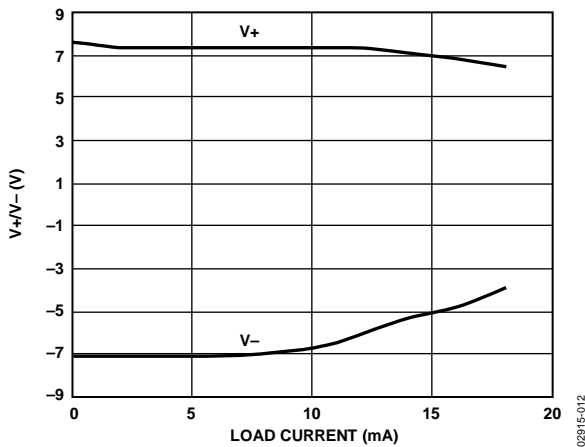

Figure 12. Charge Pump V+ / V- vs. Load Current ( $V_{CC} = 3.3\text{ V}$ )

02915-012

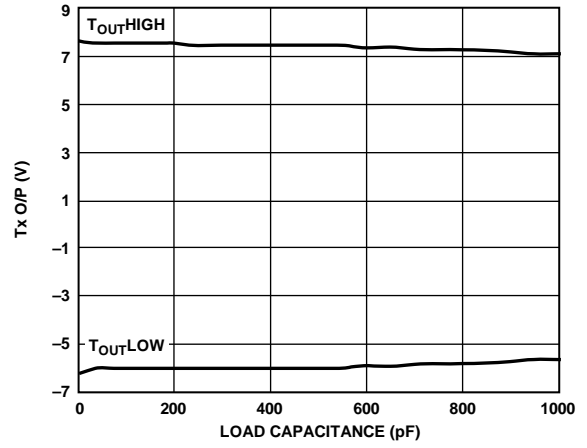

Figure 13. Transmitter Output vs. Load Capacitance ( $V_{CC} = 3.3\text{ V}$ , Data Rate = 460 kbps)

02915-013

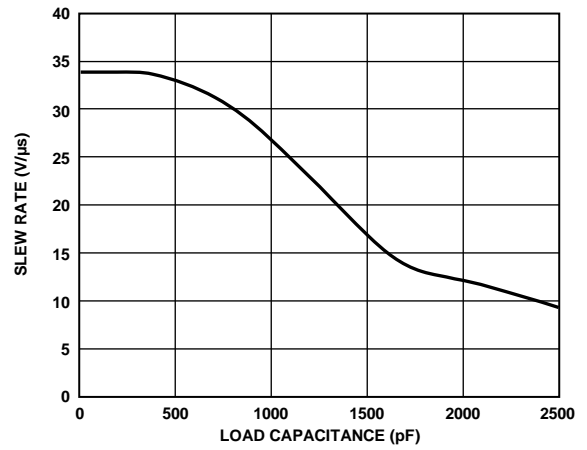

Figure 14. Slew Rate vs. Load Capacitance ( $V_{CC} = 3.3\text{ V}$ )

02915-014

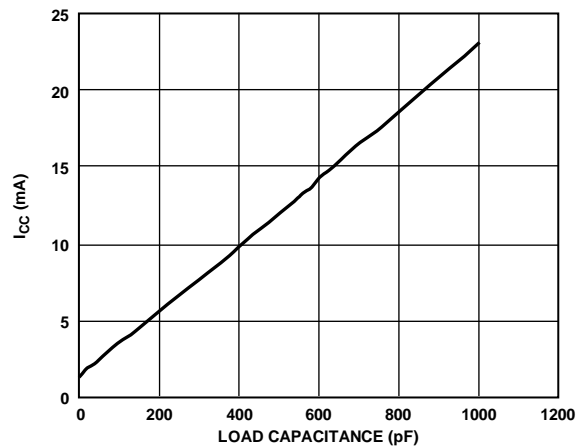

Figure 15. Supply Current vs. Load Capacitance ( $R_L = 3\text{ k}\Omega$ ,  $V_{CC} = 3.3\text{ V}$ , Data Rate = 460 kbps)

02915-015



Figure 16. Supply Current vs. Load Capacitance ( $R_L = \text{Infinite}$ ) ( $V_{CC} = 3.3 \text{ V}$ , Data Rate = 460 kbps)

02915-016



Figure 19. Transmitter Output (Low) Exiting Shutdown

02915-019

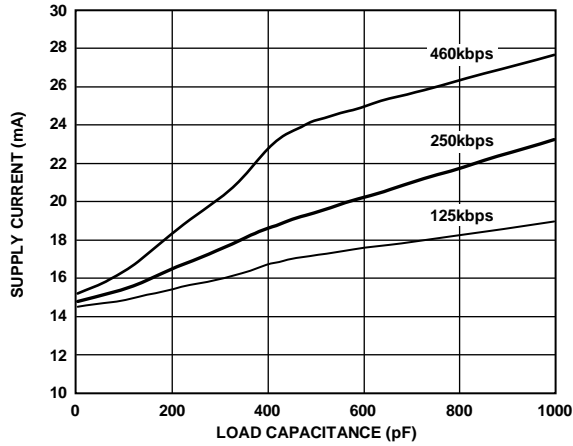

Figure 17. Supply Current vs. Load Capacitance ( $V_{CC} = 3.3 \text{ V}$ ,  $R_L = 5 \text{ k}\Omega$ )

02915-017

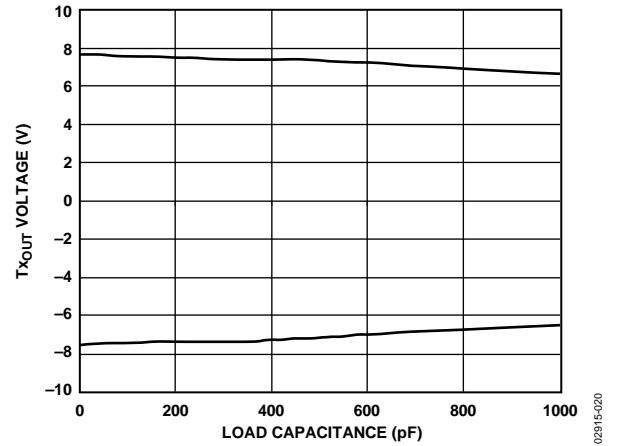

Figure 20. Transmitter Output Voltage High/Low vs. Load Capacitance ( $V_{CC} = 3.3 \text{ V}$ ,  $\text{CLK} = 1 \text{ Mb/s}$ ,  $R_L = 5 \text{ k}\Omega$ , ADM3307E)

02915-020

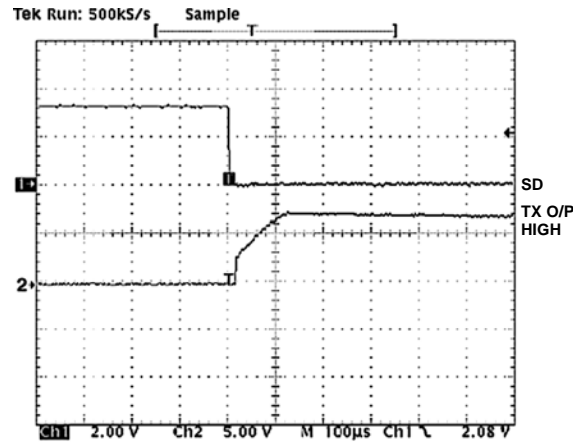

Figure 18. Transmitter Output (High) Exiting Shutdown

02915-018

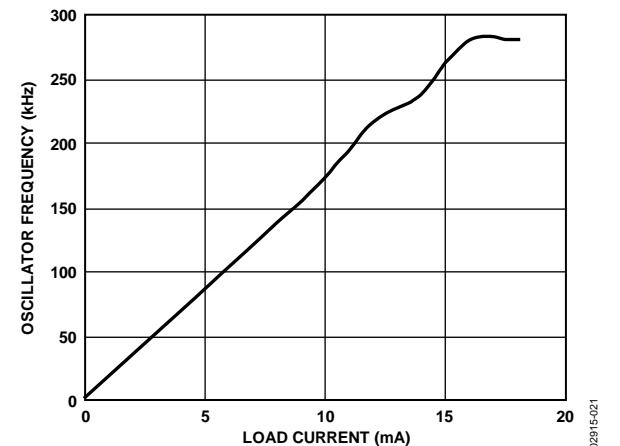

Figure 21. Oscillator Frequency vs. Load Current

02915-021



Figure 22.  $I_{CC}$  vs.  $V_{CC}$  (Unloaded)

02815-022



Figure 23.  $I_{CC}$  vs.  $V_{CC}$  ( $R_L = 3\text{ k}\Omega$ )

02815-023

## CIRCUIT DESCRIPTION

The internal circuitry consists mainly of four sections. These include the following:

- A charge pump voltage converter
- 3.3 V logic to EIA-232 transmitters
- EIA-232 to 3.3 V logic receivers
- Transient protection circuit on all I/O lines

### Charge Pump DC-to-DC Voltage Converter

The charge pump voltage converter consists of a 250 kHz (300 kHz for [ADM3307E](#)) oscillator and a switching matrix. The converter generates a  $\pm 9$  V supply from the input 3.0 V level. This is done in two stages using a switched capacitor technique. First, the 3.0 V input supply is tripled to 9.0 V using Capacitor C4 as the charge storage element. The +9.0 V level is then inverted to generate  $-9.0$  V using C5 as the storage element.

However, it should be noted that, unlike other charge pump dc-to-dc converters, the charge pump on the [ADM3307E](#) does not run open-loop. The output voltage is regulated to  $\pm 7.25$  V (or  $\pm 6.5$  V for the [ADM3310E](#) and [ADM3315E](#)) by the Green Idle circuit and never reaches  $\pm 9$  V in practice. This saves power as well as maintains a more constant output voltage.

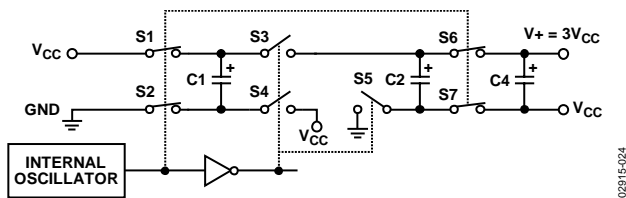

Figure 24. Charge Pump Voltage Tripler

The tripler operates in two phases. During the oscillator low phase, S1 and S2 are closed and C1 charges rapidly to  $V_{CC}$ . S3, S4, and S5 are open, and S6 and S7 are closed.

During the oscillator high phase, S1 and S2 are open, and S3 and S4 are closed, so the voltage at the output of S3 is  $2V_{CC}$ . This voltage is used to charge C2. In the absence of any discharge current, C2 charges up to  $2V_{CC}$  after several cycles. During the oscillator high phase, as previously mentioned, S6 and S7 are closed, so the voltage at the output of S6 is  $3V_{CC}$ . This voltage is then used to charge C3. The voltage inverter is illustrated in Figure 25.



Figure 25. Charge Pump Voltage Inverter

During the oscillator high phase, S10 and S11 are open, while S8 and S9 are closed. C3 is charged to  $3V_{CC}$  from the output of the voltage tripler over several cycles. During the oscillator low phase, S8 and S9 are open, while S10 and S11 are closed. C3 is connected across C5, whose positive terminal is grounded and whose negative terminal is the  $V-$  output. Over several cycles, C5 charges to  $-3V_{CC}$ .

The  $V+$  and  $V-$  supplies may also be used to power external circuitry if the current requirements are small. See Figure 12 in the Typical Performance Characteristics section.

### What Is Green Idle?

Green Idle is a method of minimizing power consumption under idle (no transmit) conditions while still maintaining the ability to transmit data instantly.

### How Does it Work?

Charge pump type dc-to-dc converters used in RS-232 line drivers normally operate open-loop, that is, the output voltage is not regulated in any way. Under light load conditions, the output voltage is close to twice the supply voltage for a doubler and three times the supply voltage for a tripler, with very little ripple. As the load current increases, the output voltage falls and the ripple voltage increases.

Even under no-load conditions, the oscillator and charge pump operate at a very high frequency with consequent switching losses and current drain.

Green Idle works by monitoring the output voltage and maintaining it at a constant value of around  $7V^1$ . When the voltage rises above  $7.25V^2$  the oscillator is turned off. When the voltage falls below  $7V^1$ , the oscillator is turned on and a burst of charging pulses is sent to the reservoir capacitor. When the oscillator is turned off, the power consumption of the charge pump is virtually zero, so the average current drain under light load conditions is greatly reduced.

<sup>1</sup> For [ADM3310E](#) and [ADM3315E](#), replace with 6.5 V.

<sup>2</sup> For [ADM3310E](#) and [ADM3315E](#), replace with 6.25 V.

A block diagram of the Green Idle circuit is shown in Figure 26. Both V+ and V- are monitored and compared to a reference voltage derived from an on-chip band gap device. If either V+ or V- fall below 7 V<sup>1</sup>, the oscillator starts up until the voltage rises above 7.25 V<sup>2</sup>.



Figure 26. Block Diagram of Green Idle Circuit

The operation of Green Idle for V+ under various load conditions is illustrated in Figure 27. Under light load conditions, C1 is maintained in a charged condition, and only a single oscillator pulse is required to charge up C2. Under these conditions, V+ may actually overshoot 7.25 V<sup>2</sup> slightly.

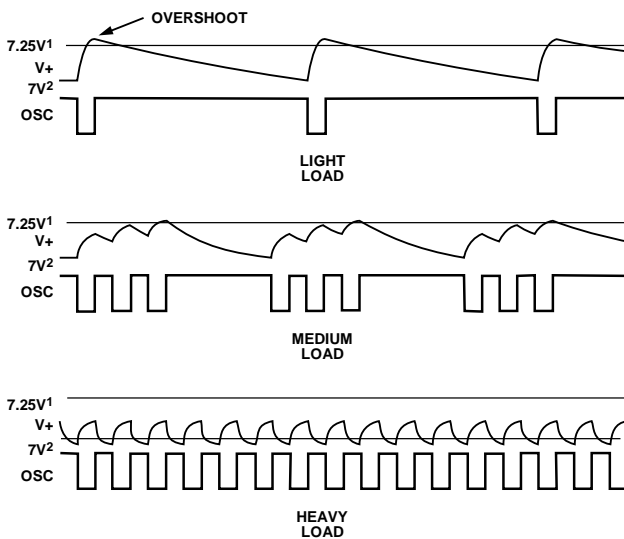

<sup>1</sup>FOR ADM3310E AND ADM3315E REPLACE WITH 6.5V.  
<sup>2</sup>FOR ADM3310E AND ADM3315E REPLACE WITH 6.25V.

Figure 27. Operation of Green Idle under Various Load Conditions

Under medium load conditions, it may take several cycles for C2 to charge up to 7.25 V<sup>2</sup>. The average frequency of the oscillator is higher because there are more pulses in each burst and the bursts of pulses are closer together and more frequent.

Under high load conditions, the oscillator is on continuously if the charge pump output cannot reach 7.25 V<sup>2</sup>.

**Green Idle Vs. Shutdown**

Shutdown mode minimizes power consumption by shutting down the charge pump altogether. In this mode, the switches in the voltage tripler are configured so V+ is connected directly to V<sub>CC</sub>. V- is zero because there is no charge pump operation to charge C5. This means there is a delay when coming out of shutdown mode before V+ and V- achieve their normal operating voltages. Green Idle maintains the transmitter supply voltages under transmitter idle conditions so this delay does not occur.

**Doesn't Green Idle Increase Supply Voltage Ripple?**

The ripple on the output voltage of a charge pump operating in open-loop depends on three factors: the oscillator frequency, the value of the reservoir capacitor, and the load current. The value of the reservoir capacitor is fixed. Increasing the oscillator frequency decreases the ripple voltage; decreasing the oscillator frequency increases it. Increasing the load current increases the ripple voltage; decreasing the load current decreases it. The ripple voltage at light loads is naturally lower than that for high load currents.

Using Green Idle, the ripple voltage is determined by the high and low thresholds of the Green Idle circuit. These are nominally 7 V<sup>1</sup> and 7.25 V<sup>2</sup>, so the ripple is 250 mV under most load conditions. With very light load conditions, there may be some overshoot above 7.25 V<sup>2</sup>, so the ripple is slightly greater. Under heavy load conditions where the output never reaches 7.25 V<sup>2</sup>, the Green Idle circuit is inoperative and the ripple voltage is determined by the load current, the same as in a normal charge pump.

**What about Electromagnetic Compatibility?**

Green Idle does not operate with a constant oscillator frequency. As a result, the frequency and spectrum of the oscillator signal vary with load. Any radiated and conducted emissions also vary accordingly. Like other Analog Devices RS-232 transceiver products, the ADM3307E/ADM3310E/ADM3311E/ADM3312E/ADM3315E devices feature slew rate limiting and other techniques to minimize radiated and conducted emissions.

<sup>1</sup> For ADM3310E and ADM3315E, replace with 6.5 V.  
<sup>2</sup> For ADM3310E and ADM3315E, replace with 6.25 V.

### Transmitter (Driver) Section

The drivers convert 3.3 V logic input levels into EIA-232 output levels. With  $V_{CC} = 3.0$  V and driving an EIA-232 load, the output voltage swing is typically  $\pm 6.4$  V (or  $\pm 5.5$  V for [ADM3310E](#) and [ADM3315E](#)).

Unused inputs may be left unconnected, because an internal 400 k $\Omega$  pull-up resistor pulls them high forcing the outputs into a low state. The input pull-up resistors typically source 8 mA when grounded, so unused inputs should either be connected to  $V_{CC}$  or left unconnected in order to minimize power consumption.

### Receiver Section

The receivers are inverting level shifters that accept RS-232 input levels and translate them into 3.3 V logic output levels. The inputs have internal 5 k $\Omega$  pull-down resistors (22 k $\Omega$  for the [ADM3310E](#)) to ground and are also protected against overvoltages of up to  $\pm 30$  V. Unconnected inputs are pulled to 0 V by the internal 5 k $\Omega$  (or 22 k $\Omega$  for the [ADM3315E](#)) pull-down resistor. This, therefore, results in a Logic 1 output level for unconnected inputs or for inputs connected to GND.

The receivers have Schmitt trigger inputs with a hysteresis level of 0.14 V. This ensures error-free reception for both noisy inputs and for inputs with slow transition times.

### ENABLE AND SHUTDOWN

The enable function is intended to facilitate data bus connections where it is desirable to three-state the receiver outputs. In the disabled mode, all receiver outputs are placed in a high impedance state. The shutdown function is intended to shut the device down, thereby minimizing the quiescent current. In shutdown, all transmitters are disabled. All receivers are shut down, except for Receiver R3 ([ADM3307E](#), [ADM3312E](#), and [ADM3315E](#)), Receiver R5 ([ADM3311E](#)), and Receiver R4 and Receiver R5 ([ADM3310E](#)). Note that disabled transmitters are not three-stated in shutdown, so it is not permitted to connect multiple (RS-232) driver outputs together.

The shutdown feature is very useful in battery-operated systems because it reduces the power consumption to 66 nW. During shutdown, the charge pump is also disabled. When exiting shutdown, the charge pump is restarted and it takes approximately 100  $\mu$ s for it to reach its steady-state operating conditions.



Figure 28. Receiver Disable Timing



Figure 29. Receiver Enable Timing

### High Baud Rate

The [ADM3307E/ADM3310E/ADM3311E/ADM3312E/ADM3315E](#) feature high slew rates, permitting data transmission at rates well in excess of the EIA/RS-232E specifications. RS-232 voltage levels are maintained at data rates up to 230 kbps (460 kbps for [ADM3307E](#)) under worst-case loading conditions. This allows for high speed data links between two terminals.

### LAYOUT AND SUPPLY DECOUPLING

Because of the high frequencies at which the [ADM3307E/ADM3310E/ADM3311E/ADM3312E/ADM3315E](#) oscillator operates, particular care should be taken with printed circuit board layout, with all traces being as short as possible and C1 to C3 being connected as close to the device as possible. The use of a ground plane under and around the device is also highly recommended.

When the oscillator starts up during Green Idle operation, large current pulses are taken from  $V_{CC}$ . For this reason,  $V_{CC}$  should be decoupled with a parallel combination of 10  $\mu$ F tantalum and 0.1  $\mu$ F ceramic capacitors, mounted as close to the  $V_{CC}$  pin as possible.

Capacitor C1 to Capacitor C3 can have values between 0.1  $\mu$ F and 1  $\mu$ F. Larger values give lower ripple. These capacitors can be either electrolytic capacitors chosen for low equivalent series resistance (ESR) or nonpolarized types, but the use of ceramic types is highly recommended. If polarized electrolytic capacitors are used, polarity must be observed (as shown by C1+).

### ESD/EFT TRANSIENT PROTECTION SCHEME

The [ADM3307E/ADM3310E/ADM3311E/ADM3312E/ADM3315E](#) use protective clamping structures on all inputs and outputs that clamp the voltage to a safe level and dissipate the energy present in ESD (electrostatic) and EFT (electrical fast transients) discharges. A simplified schematic of the protection structure is shown in Figure 30 and Figure 31 (see Figure 32 and Figure 33 for [ADM3307E](#) protection structure).

Each input and output contains two back-to-back high speed clamping diodes. During normal operation with maximum RS-232 signal levels, the diodes have no effect as one or the other is reverse biased depending on the polarity of the signal. If, however, the voltage exceeds about  $\pm 50$  V, reverse breakdown occurs and the voltage is clamped at this level. The diodes are large p-n junctions designed to handle the instantaneous current surge that can exceed several amperes.

The transmitter outputs and receiver inputs have a similar protection structure. The receiver inputs can also dissipate some of the energy through the internal 5 kΩ (or 22 kΩ for the ADM3310E) resistor to GND as well as through the protection diodes.

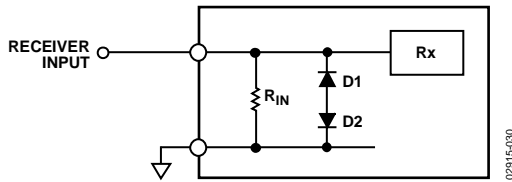

Figure 30. Receiver Input Protection Scheme

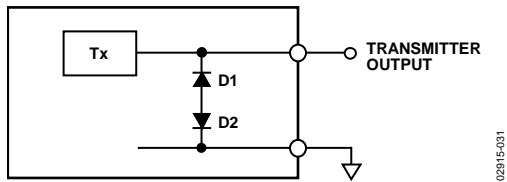

Figure 31. Transmitter Output Protection Scheme

The ADM3307E protection scheme is slightly different (see Figure 32 and Figure 33). The receiver inputs, transmitter inputs, and transmitter outputs contain two back-to-back high speed clamping diodes. The receiver outputs (CMOS outputs), the SD and EN pins, contain a single reverse biased high speed clamping diode. Under normal operation with maximum CMOS signal levels, the receiver output, SD, and EN protection diodes have no effect because they are reversed biased. If, however, the voltage exceeds about 15 V, reverse breakdown occurs and the voltage is clamped at this level. If the voltage reaches -0.7 V, the diode is forward biased and the voltage is clamped at this level. The receiver inputs can also dissipate some of the energy through the internal 5 kΩ resistor to GND as well as through the protection diodes.

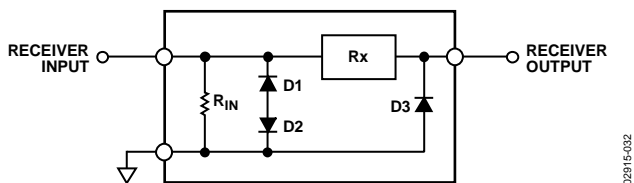

Figure 32. ADM3307E Receiver Input Protection Scheme

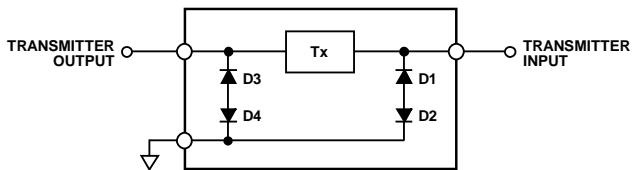

Figure 33. ADM3307E Transmitter Output Protection Scheme

The protection structures achieve ESD protection up to ±15 kV on all RS-232 I/O lines (and all CMOS lines, including SD and EN for the ADM3307E). For methods used to test the protection scheme, see the ESD Testing (IEC 1000-4-2) section.

ESD TESTING (IEC 1000-4-2)

IEC 1000-4-2 (previously 801-2) specifies compliance testing using two coupling methods, contact discharge and air-gap discharge. Contact discharge calls for a direct connection to the unit being tested. Airgap discharge uses a higher test voltage but does not make direct contact with the unit under testing. With air discharge, the discharge gun is moved toward the unit under testing, which develops an arc across the air gap, thus the term air discharge. This method is influenced by humidity, temperature, barometric pressure, distance, and rate of closure of the discharge gun. The contact discharge method, while less realistic, is more repeatable and is gaining acceptance in preference to the air-gap method.

Although very little energy is contained within an ESD pulse, the extremely fast rise time coupled with high voltages can cause failures in unprotected semiconductors. Catastrophic destruction can occur immediately as a result of arcing or heating. Even if catastrophic failure does not occur immediately, the device can suffer from parametric degradation that can result in degraded performance. The cumulative effects of continuous exposure can eventually lead to complete failure.

I/O lines are particularly vulnerable to ESD damage. Simply touching or plugging in an I/O cable can result in a static discharge that can damage or completely destroy the interface product connected to the I/O port. Traditional ESD test methods, such as the MIL-STD-883B method 3015.7, do not fully test a product's susceptibility to this type of discharge. This test was intended to test a product's susceptibility to ESD damage during handling.

Each pin is tested with respect to ground. There are some important differences between the traditional test and the IEC test.

- The IEC test is much more stringent in terms of discharge energy. The peak current injected is over four times greater.
- The current rise time is significantly faster in the IEC test.
- The IEC test is carried out while power is applied to the device.

It is possible that the ESD discharge could induce latch-up in the device under test. This test, therefore, is more representative of a real world I/O discharge where the equipment is operating normally with power applied. For maximum peace of mind, however, both tests should be performed, ensuring maximum protection both during handling and later during field service.

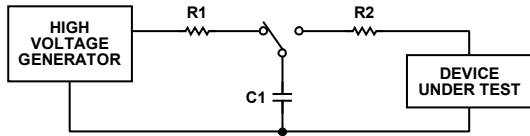

| ESD TEST METHOD                         | R2    | C1    |
|---|-------|-------|
| HUMAN BODY MODEL<br>ESD ASSOC. STD 55.1 | 1.5kΩ | 100pF |
| IEC1000-4-2                             | 330Ω  | 150pF |

02815-034

Figure 34. ESD Test Standards

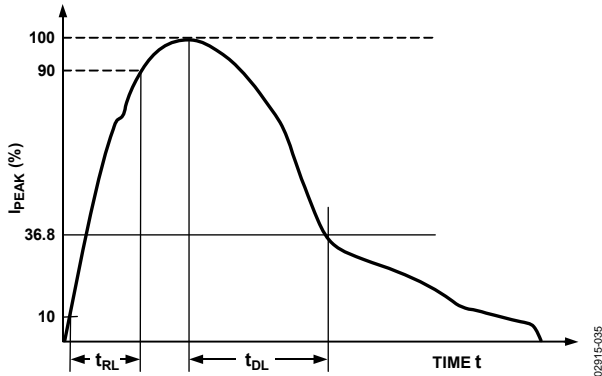

02815-035

Figure 35. Human Body Model ESD Current Waveform



02815-036

Figure 36. IEC1000-4-2 ESD Current Waveform

The ADM3307E/ADM3310E/ADM3311E/ADM3312E/ADM3315E devices are tested using both of the previously mentioned test methods. All pins are tested with respect to all other pins as per the Human Body Model, ESD Assoc. Std. 55.1 specification. In addition, all I/O pins are tested as per the IEC 1000-4-2 test specification. The products were tested under the following conditions:

- Power-On—Normal Operation
- Power-Off

There are four levels of compliance defined by IEC 1000-4-2. The ADM3307E/ADM3310E/ADM3311E/ADM3312E/ADM3315E devices meet the most stringent compliance level for both contact and air-gap discharge. This means the products are able to withstand contact discharges in excess of 8 kV and airgap discharges in excess of 15 kV.

Table 9. IEC 1000-4-2 Compliance Levels

| Level | Contact Discharge (kV) | Air Discharge (kV) |
|-------|------------------------|--------------------|
| 1     | 2                      | 2                  |
| 2     | 4                      | 4                  |
| 3     | 6                      | 8                  |
| 4     | 8                      | 15                 |

OUTLINE DIMENSIONS



COMPLIANT TO JEDEC STANDARDS MO-220-WHHD.

Figure 37. 32-Lead Lead Frame Chip Scale Package [LFCSP\_WQ]  
 5 mm × 5 mm Body, Very Very Thin Quad  
 (CP-32-7)  
 Dimensions shown in millimeters

112408-A



COMPLIANT TO JEDEC STANDARDS MO-150-AH

Figure 38. 28-Lead Shrink Small Outline Package [SSOP]  
 (RS-28)  
 Dimensions shown in millimeters

060106-A



COMPLIANT TO JEDEC STANDARDS MO-153-AD

Figure 39. 24-Lead Thin Shrink Small Outline Package [TSSOP] (RU-24)

Dimensions shown in millimeters

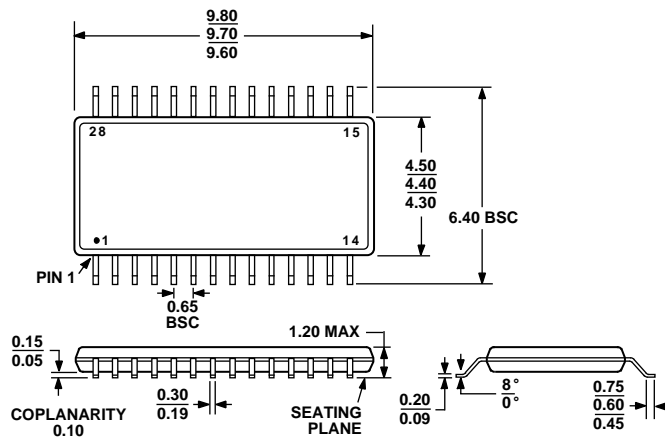

COMPLIANT TO JEDEC STANDARDS MO-153-AE

Figure 40. 28-Lead Thin Shrink Small Outline Package [TSSOP] (RU-28)

Dimensions shown in millimeters

## ORDERING GUIDE

| Model <sup>1,2</sup> | Temperature Range | Package Description                              | Package Option |
|----------------------|-------------------|--|----------------|
| ADM3307EARU-REEL7    | -40°C to +85°C    | 28-Lead 7" Tape and Reel                         | RU-28          |
| ADM3307EARUZ         | -40°C to +85°C    | 28-Lead Thin Shrink Small Outline [TSSOP]        | RU-28          |
| ADM3307EARUZ-REEL    | -40°C to +85°C    | 28-Lead 13" Tape and Reel                        | RU-28          |
| ADM3307EARUZ-REEL7   | -40°C to +85°C    | 28-Lead 7" Tape and Reel                         | RU-28          |
| ADM3307EACPZ         | -40°C to +85°C    | 32-Lead Lead Frame Chip Scale Package [LFCSP_WQ] | CP-32-7        |
| ADM3307EACPZ-REEL    | -40°C to +85°C    | 32-Lead LFCSP_WQ 13" Tape and Reel               | CP-32-7        |
| ADM3307EACPZ-REEL7   | -40°C to +85°C    | 32-Lead LFCSP_WQ 7" Tape and Reel                | CP-32-7        |
| ADM3307EWARUZ-RL7    | -40°C to +85°C    | 28-Lead 7" Tape and Reel                         | RU-28          |
| ADM3310EARU          | -40°C to +85°C    | 28-Lead Thin Shrink Small Outline [TSSOP]        | RU-28          |
| ADM3310EARUZ         | -40°C to +85°C    | 28-Lead Thin Shrink Small Outline [TSSOP]        | RU-28          |
| ADM3310EARUZ-REEL    | -40°C to +85°C    | 28-Lead TSSOP 13" Tape and Reel                  | RU-28          |
| ADM3310EARUZ-REEL7   | -40°C to +85°C    | 28-Lead TSSOP 7" Tape and Reel                   | RU-28          |
| ADM3310EACPZ         | -40°C to +85°C    | 32-Lead Lead Frame Chip Scale Package [LFCSP_WQ] | CP-32-7        |
| ADM3310EACPZ-REEL7   | -40°C to +85°C    | 32-Lead LFCSP_WQ 7" Tape and Reel                | CP-32-7        |
| ADM3311EARS          | -40°C to +85°C    | 28-Lead Shrink Small Outline [SSOP]              | RS-28          |
| ADM3311EARSZ         | -40°C to +85°C    | 28-Lead Shrink Small Outline [SSOP]              | RS-28          |
| ADM3311EARSZ-REEL    | -40°C to +85°C    | 28-Lead SSOP 13" Tape and Reel                   | RS-28          |
| ADM3311EARSZ-REEL7   | -40°C to +85°C    | 28-Lead SSOP 7" Tape and Reel                    | RS-28          |
| ADM3311EARUZ         | -40°C to +85°C    | 28-Lead Thin Shrink Small Outline [TSSOP]        | RU-28          |
| ADM3311EARUZ-REEL    | -40°C to +85°C    | 28-Lead TSSOP 13" Tape and Reel                  | RU-28          |
| ADM3311EARUZ-REEL7   | -40°C to +85°C    | 28-Lead TSSOP 7" Tape and Reel                   | RU-28          |
| ADM3311EACPZ         | -40°C to +85°C    | 32-Lead Lead Frame Chip Scale Package [LFCSP_WQ] | CP-32-7        |
| ADM3311EACPZ-REEL7   | -40°C to +85°C    | 32-Lead LFCSP_WQ 7" Tape and Reel                | CP-32-7        |
| ADM3312EARU          | -40°C to +85°C    | 24-Lead Thin Shrink Small Outline [TSSOP]        | RU-24          |
| ADM3312EARU-REEL7    | -40°C to +85°C    | 24-Lead TSSOP 7" Tape and Reel                   | RU-24          |
| ADM3312EARUZ         | -40°C to +85°C    | 24-Lead Thin Shrink Small Outline [TSSOP]        | RU-24          |
| ADM3312EARUZ-REEL    | -40°C to +85°C    | 24-Lead TSSOP 13" Tape and Reel                  | RU-24          |
| ADM3312EARUZ-REEL7   | -40°C to +85°C    | 24-Lead TSSOP 7" Tape and Reel                   | RU-24          |
| ADM3312EACPZ         | -40°C to +85°C    | 32-Lead Lead Frame Chip Scale Package [LFCSP_WQ] | CP-32-7        |
| ADM3312EACPZ-REEL7   | -40°C to +85°C    | 32-Lead LFCSP_WQ 7" Tape and Reel                | CP-32-7        |
| ADM3315EARU          | -40°C to +85°C    | 24-Lead Thin Shrink Small Outline [TSSOP]        | RU-24          |
| ADM3315EARU-REEL     | -40°C to +85°C    | 24-Lead TSSOP 13" Tape and Reel                  | RU-24          |
| ADM3315EARUZ         | -40°C to +85°C    | 24-Lead Thin Shrink Small Outline [TSSOP]        | RU-24          |
| ADM3315EARUZ-REEL    | -40°C to +85°C    | 24-Lead TSSOP 13" Tape and Reel                  | RU-24          |
| ADM3315EARUZ-REEL7   | -40°C to +85°C    | 24-Lead TSSOP 7" Tape and Reel                   | RU-24          |
| ADM3315EACPZ         | -40°C to +85°C    | 32-Lead Lead Frame Chip Scale Package [LFCSP_WQ] | CP-32-7        |
| ADM3315EACPZ-REEL    | -40°C to +85°C    | 32-Lead LFCSP_WQ 13" Tape and Reel               | CP-32-7        |
| ADM3315EACPZ-REEL7   | -40°C to +85°C    | 32-Lead LFCSP_WQ 7" Tape and Reel                | CP-32-7        |

<sup>1</sup> Z = RoHS Compliant Part.

<sup>2</sup> W = Qualified for Automotive Applications.

## AUTOMOTIVE PRODUCTS

The [ADM3307EW](#) model is available with controlled manufacturing to support the quality and reliability requirements of automotive applications. Note that this automotive model may have specifications that differ from the commercial models; therefore, designers should review the Specifications section of this data sheet carefully. Only the automotive grade products shown are available for use in automotive applications. Contact your local Analog Devices account representative for specific product ordering information and to obtain the specific Automotive Reliability reports for this model.

## Looking for pricing, stock, or lifecycle information?

Click below to explore more details on WIN SOURCE:

 [View ADM3311EARSZ-REEL7 on WIN SOURCE](#)

 [Analog Devices Inc. Information](#)

## Optimize Your Supply Chain with WIN SOURCE Solutions

-  Global Sourcing Solution
-  Obsolete Management
-  Cost Control Management
-  Shortage Management
-  Alternative Solution
-  Excess Inventory Management