



**THE DATASHEET OF
ETC1.6-4-2-3TR**



ETC1.6-4-2-3TR



E-Series RF 4:1 Transmission Line Transformer 500-3000MHz

Rev. V5

Features

- Surface Mount
- 4:1 Impedance Ratio
- RoHS Compliant, lead free
- CT on Secondary
- Available on Tape and Reel

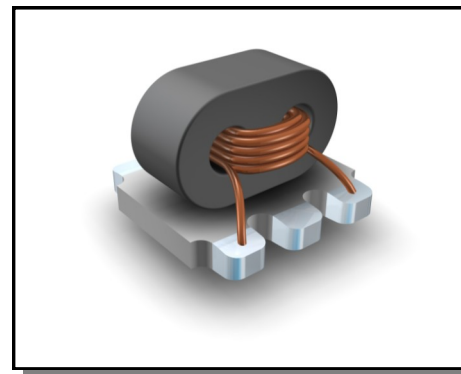

Electrical Specifications @25°C

Parameter	Units	Nominal	Maximum	Mean (x)	Sigma (σ)
Frequency Range 500 - 3000	MHz	—	—	—	—
Insertion Loss ($f_L - f_U$)					
500 - 750 MHz	dB	—	3.0	—	—
750 - 1200 MHz	dB	—	1.0	0.22	0.159
1200 - 3000 MHz	dB	—	3.0	—	—

Note: Mean and Sigma calculated from average loss at @ $(f_U - f_L)/2 + f_L$

Please Note that the photograph above indicates package only, not actual unit.

Pin Configuration

Pin No.	Function
1	Secondary Dot
2	Secondary CT
3	Secondary
4	Primary
5	Primary Dot

Schematic

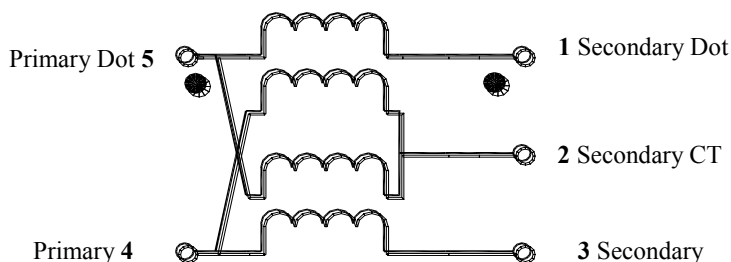

Typical Performance Over Extended Bandwidth (30kHz - 3.0GHz)

Insertion Loss

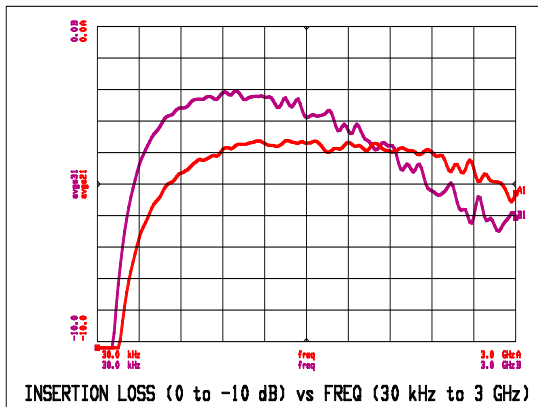

Phase Unbalance

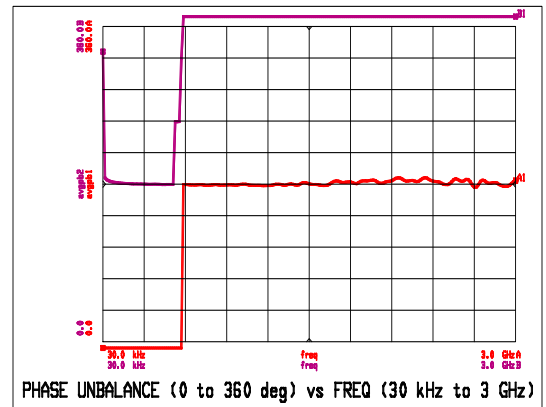

Amplitude Unbalance

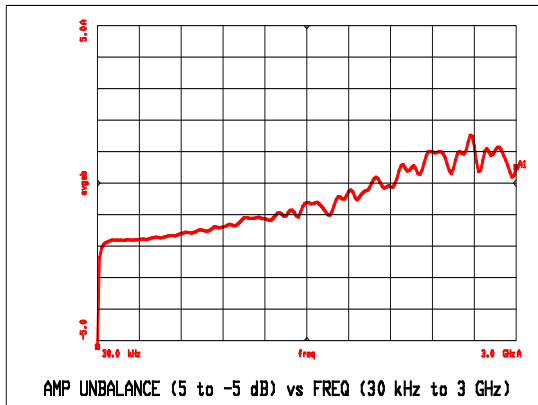

Input Impedance

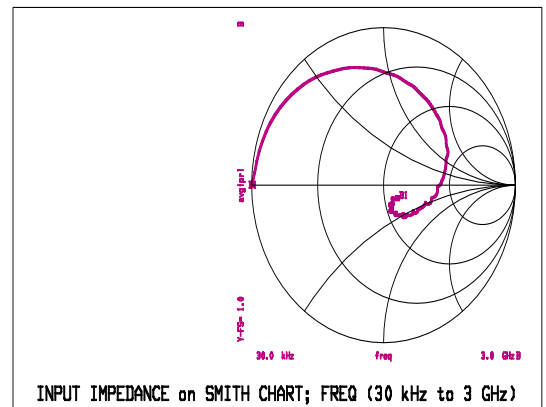

Outline Drawing

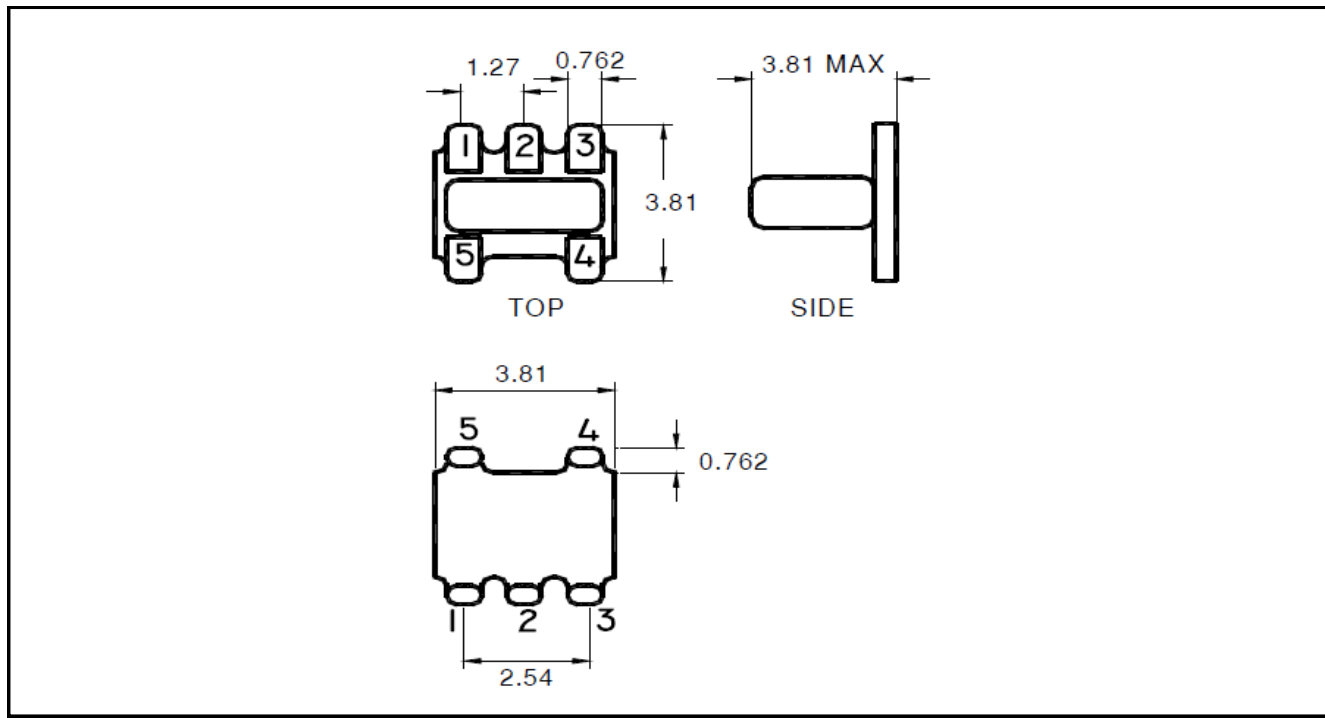

1. Dimensions in mm.
2. Tolerance: ± 0.2 mm unless otherwise noted.
3. Model number and lot code are printed on the reel.
4. Termination plating is Sn.

Recommended Footprint

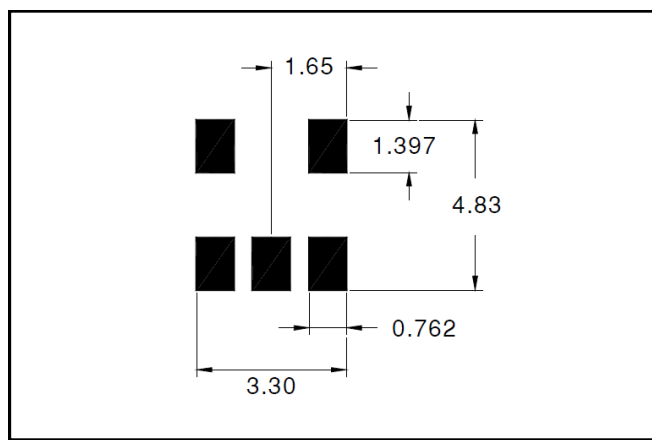

ETC1.6-4-2-3TR



E-Series RF 4:1 Transmission Line
Transformer 500-3000MHz

Rev. V5

Tape & Reel Information

Parameter	Units	Value
Qty per reel	-	2000
Reel Size	mm	330
Tape Width	mm	12.00
Pitch	mm	8.00
Ao	mm	4.39
Bo	mm	4.35
Ko	mm	3.67
Orientation	-	F5
Reference Application Note ANI-019 for orientation		

Ordering Information



Part Number	Description
ETC1.6-4-2-3TR	2000 piece reel
ETC1.6-4-2-3TB	Customer Test Board

Recommended Maximum Ratings



Parameter	Value
RF power	250mW
DC current	30mA
Operating Temperature	-40°C to +85°C
Storage Temperature	-40°C to +85°C

Looking for pricing, stock, or lifecycle information?

Click below to explore more details on WIN SOURCE:

-  [View ETC1.6-4-2-3TR on WIN SOURCE](#)
-  [M/A-Com Technology Solutions Information](#)

Optimize Your Supply Chain with WIN SOURCE Solutions

-  Global Sourcing Solution
-  Obsolete Management
-  Cost Control Management
-  Shortage Management
-  Alternative Solution
-  Excess Inventory Management