



**THE DATASHEET OF  
FMG2G75US60**



## FMG2G75US60

### Molding Type Module

#### General Description

Fairchild's Insulated Gate Bipolar Transistor (IGBT) power modules provide low conduction and switching losses as well as short circuit ruggedness. They are designed for applications such as motor control, uninterrupted power supplies (UPS) and general inverters where short circuit ruggedness is a required feature.

#### Features

- UL Certified No. E209204
- Short Circuit rated 10us @  $T_C = 100^\circ\text{C}$ ,  $V_{GE} = 15\text{V}$
- High Speed Switching
- Low Saturation Voltage :  $V_{CE(\text{sat})} = 2.2\text{V}$  @  $I_C = 75\text{A}$
- High Input Impedance
- Fast & Soft Anti-Parallel FWD

#### Application

- AC & DC Motor Controls
- General Purpose Inverters
- Robotics
- Servo Controls
- UPS



Package Code : 7PM-GA

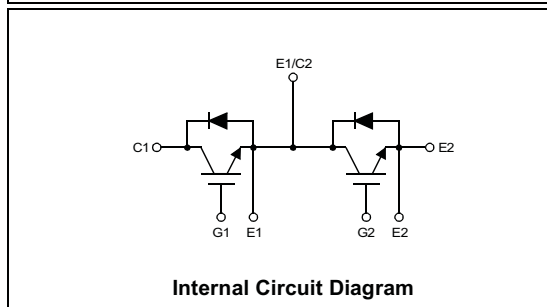

Internal Circuit Diagram

#### Absolute Maximum Ratings $T_C = 25^\circ\text{C}$ unless otherwise noted

| Symbol          | Description  | FMG2G75US60 | Units            |
|-----------------|--|-------------|------------------|
| $V_{CES}$       | Collector-Emitter Voltage                                    | 600         | V                |
| $V_{GES}$       | Gate-Emitter Voltage   | $\pm 20$    | V                |
| $I_C$           | Collector Current @ $T_C = 25^\circ\text{C}$                 | 75          | A                |
| $I_{CM(1)}$     | Pulsed Collector Current                                     | 150         | A                |
| $I_F$           | Diode Continuous Forward Current @ $T_C = 100^\circ\text{C}$ | 75          | A                |
| $I_{FM}$        | Diode Maximum Forward Current                                | 150         | A                |
| $T_{SC}$        | Short Circuit Withstand Time @ $T_C = 100^\circ\text{C}$     | 10          | us               |
| $P_D$           | Maximum Power Dissipation @ $T_C = 25^\circ\text{C}$         | 310         | W                |
| $T_J$           | Operating Junction Temperature                               | -40 to +150 | $^\circ\text{C}$ |
| $T_{stg}$       | Storage Temperature Range                                    | -40 to +125 | $^\circ\text{C}$ |
| $V_{iso}$       | Isolation Voltage @ AC 1minute                               | 2500        | V                |
| Mounting Torque | Power Terminals Screw : M5                                   | 2.0         | N.m              |
|                 | Mounting Screw : M5  | 2.0         | N.m              |

**Notes :**

(1) Repetitive rating : Pulse width limited by max. junction temperature

**Electrical Characteristics of IGBT**  $T_C = 25^\circ\text{C}$  unless otherwise noted

| Symbol                           | Parameter                               | Test Conditions   | Min. | Typ. | Max.      | Units        |
|----------------------------------|---|---|------|------|-----------|--------------|
| <b>Off Characteristics</b>       |   |   |      |      |           |              |
| $BV_{CES}$                       | Collector-Emitter Breakdown Voltage     | $V_{GE} = 0V, I_C = 250\mu A$   | 600  | --   | --        | V            |
| $\Delta BV_{CES}/\Delta T_J$     | Temperature Coeff. of Breakdown Voltage | $V_{GE} = 0V, I_C = 1mA$  | --   | 0.6  | --        | $V/^\circ C$ |
| $I_{CES}$                        | Collector Cut-Off Current               | $V_{CE} = V_{CES}, V_{GE} = 0V$   | --   | --   | 250       | $\mu A$      |
| $I_{GES}$                        | G-E Leakage Current                     | $V_{GE} = V_{GES}, V_{CE} = 0V$   | --   | --   | $\pm 100$ | nA           |
| <b>On Characteristics</b>        |   |   |      |      |           |              |
| $V_{GE(th)}$                     | G-E Threshold Voltage                   | $V_{GE} = 0V, I_C = 75mA$   | 5.0  | 6.0  | 8.5       | V            |
| $V_{CE(sat)}$                    | Collector to Emitter Saturation Voltage | $I_C = 75A, V_{GE} = 15V$   | --   | 2.2  | 2.8       | V            |
| <b>Dynamic Characteristics</b>   |   |   |      |      |           |              |
| $C_{ies}$                        | Input Capacitance                       | $V_{CE} = 30V, V_{GE} = 0V,$<br>$f = 1MHz$  | --   | 7056 | --        | pF           |
| $C_{oes}$                        | Output Capacitance                      |   | --   | 672  | --        | pF           |
| $C_{res}$                        | Reverse Transfer Capacitance            |   | --   | 180  | --        | pF           |
| <b>Switching Characteristics</b> |   |   |      |      |           |              |
| $t_{d(on)}$                      | Turn-On Delay Time                      | $V_{CC} = 300V, I_C = 75A,$<br>$R_G = 3.3\Omega, V_{GE} = 15V$<br>Inductive Load, $T_C = 25^\circ C$  | --   | 20   | --        | ns           |
| $t_r$                            | Rise Time                               |   | --   | 40   | --        | ns           |
| $t_{d(off)}$                     | Turn-Off Delay Time                     |   | --   | 70   | --        | ns           |
| $t_f$                            | Fall Time                               |   | --   | 110  | 200       | ns           |
| $E_{on}$                         | Turn-On Switching Loss                  |   | --   | 1.4  | --        | mJ           |
| $E_{off}$                        | Turn-Off Switching Loss                 | --  | 1.7  | --   | mJ        |              |
| $E_{ts}$                         | Total Switching Loss                    | --  | 3.1  | --   | mJ        |              |
| $t_{d(on)}$                      | Turn-On Delay Time                      | $V_{CC} = 300V, I_C = 75A,$<br>$R_G = 3.3\Omega, V_{GE} = 15V$<br>Inductive Load, $T_C = 125^\circ C$ | --   | 20   | --        | ns           |
| $t_r$                            | Rise Time                               |   | --   | 50   | --        | ns           |
| $t_{d(off)}$                     | Turn-Off Delay Time                     |   | --   | 80   | --        | ns           |
| $t_f$                            | Fall Time                               |   | --   | 250  | --        | ns           |
| $E_{on}$                         | Turn-On Switching Loss                  |   | --   | 1.6  | --        | mJ           |
| $E_{off}$                        | Turn-Off Switching Loss                 | --  | 3.0  | --   | mJ        |              |
| $E_{ts}$                         | Total Switching Loss                    | --  | 4.6  | --   | mJ        |              |
| $T_{sc}$                         | Short Circuit Withstand Time            | $V_{CC} = 300V, V_{GE} = 15V$<br>@ $T_C = 100^\circ C$  | 10   | --   | --        | us           |
| $Q_g$                            | Total Gate Charge                       | $V_{CE} = 300V, I_C = 75A,$<br>$V_{GE} = 15V$   | --   | 310  | 350       | nC           |
| $Q_{ge}$                         | Gate-Emitter Charge                     |   | --   | 62   | --        | nC           |
| $Q_{gc}$                         | Gate-Collector Charge                   |   | --   | 130  | --        | nC           |

**Electrical Characteristics of DIODE**  $T_C = 25^\circ\text{C}$  unless otherwise noted

| Symbol   | Parameter                           | Test Conditions                                   | Min.                      | Typ. | Max. | Units |    |
|----------|-------------------------------------|---|---------------------------|------|------|-------|----|
| $V_{FM}$ | Diode Forward Voltage               | $I_F = 75\text{A}$                                | $T_C = 25^\circ\text{C}$  | --   | 1.9  | 2.8   | V  |
|          |                                     |   | $T_C = 100^\circ\text{C}$ | --   | 1.8  | --    |    |
| $t_{rr}$ | Diode Reverse Recovery Time         |   | $T_C = 25^\circ\text{C}$  | --   | 90   | 130   | ns |
|          |                                     |   | $T_C = 100^\circ\text{C}$ | --   | 130  | --    |    |
| $I_{rr}$ | Diode Peak Reverse Recovery Current | $I_F = 75\text{A}$<br>$di / dt = 150\text{ A/us}$ | $T_C = 25^\circ\text{C}$  | --   | 7    | 9     | A  |
|          |                                     |   | $T_C = 100^\circ\text{C}$ | --   | 10   | --    |    |
| $Q_{rr}$ | Diode Reverse Recovery Charge       |   | $T_C = 25^\circ\text{C}$  | --   | 315  | 590   | nC |
|          |                                     |   | $T_C = 100^\circ\text{C}$ | --   | 650  | --    |    |

**Thermal Characteristics**

| Symbol          | Parameter                                     | Typ. | Max. | Units              |
|-----------------|---|------|------|--------------------|
| $R_{\theta JC}$ | Junction-to-Case (IGBT Part, per 1/2 Module)  | --   | 0.4  | $^\circ\text{C/W}$ |
| $R_{\theta JC}$ | Junction-to-Case (DIODE Part, per 1/2 Module) | --   | 0.9  | $^\circ\text{C/W}$ |
| $R_{\theta CS}$ | Case-to-Sink (Conductive grease applied)      | 0.05 | --   | $^\circ\text{C/W}$ |
| Weight          | Weight of Module                              | --   | 190  | g                  |

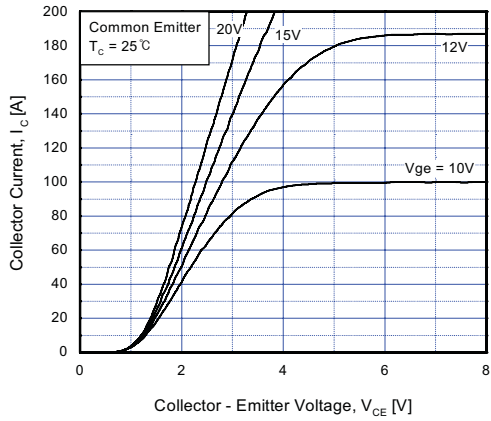

Fig 1. Typical Output Characteristics

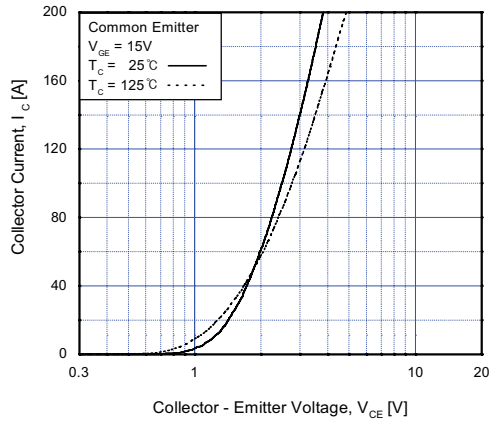

Fig 2. Typical Saturation Voltage Characteristics

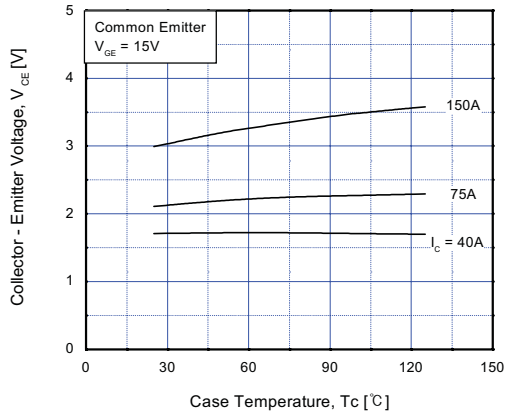

Fig 3. Saturation Voltage vs. Case Temperature at Variant Current Level

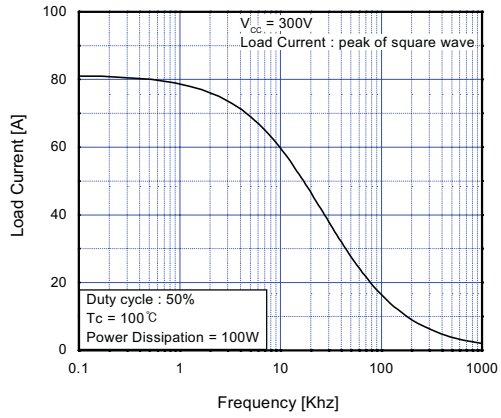

Fig 4. Load Current vs. Frequency

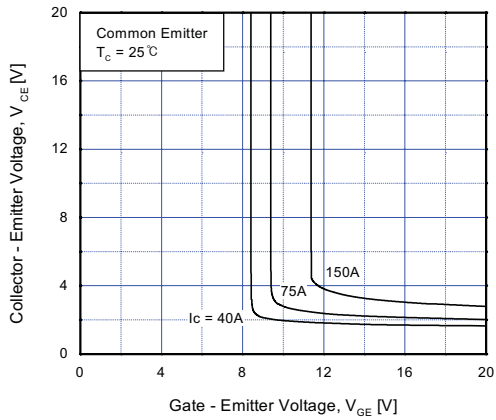

Fig 5. Saturation Voltage vs.  $V_{GE}$

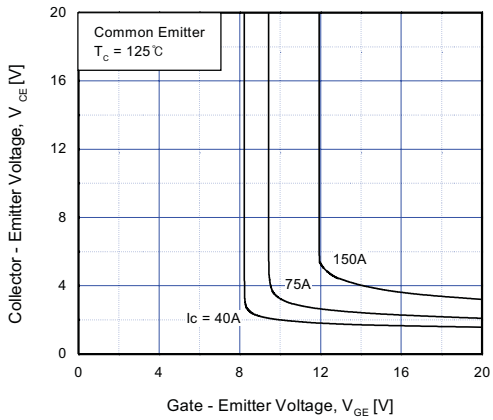

Fig 6. Saturation Voltage vs.  $V_{GE}$

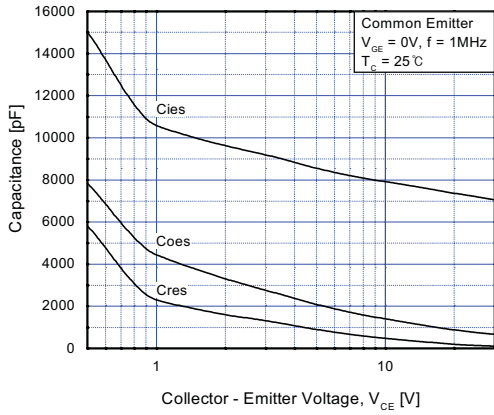

Fig 7. Capacitance Characteristics

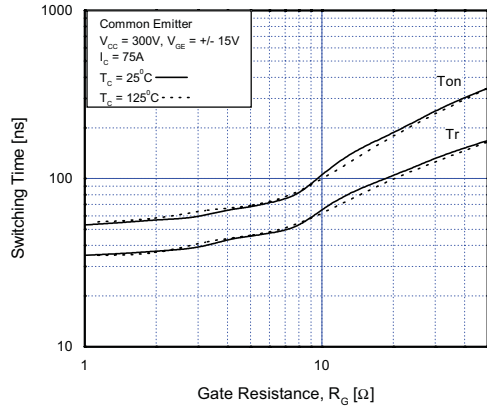

Fig 8. Turn-On Characteristics vs.

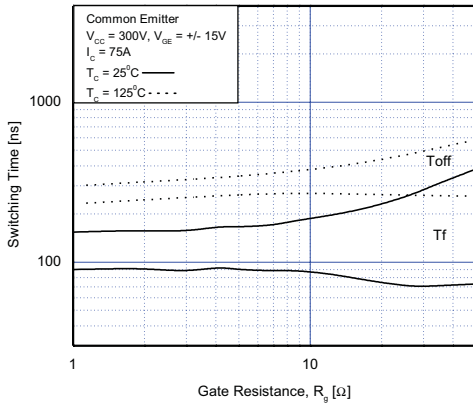

Fig 9. Turn-Off Characteristics vs. Gate Resistance

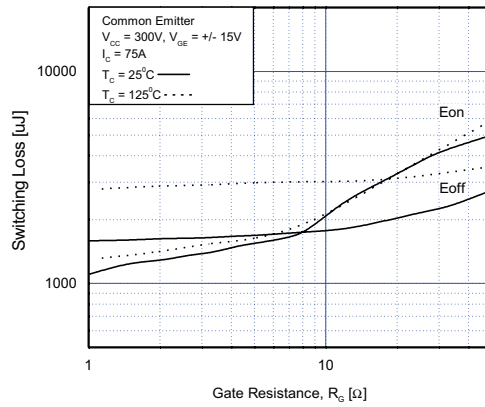

Fig 10. Switching Loss vs. Gate Resistance

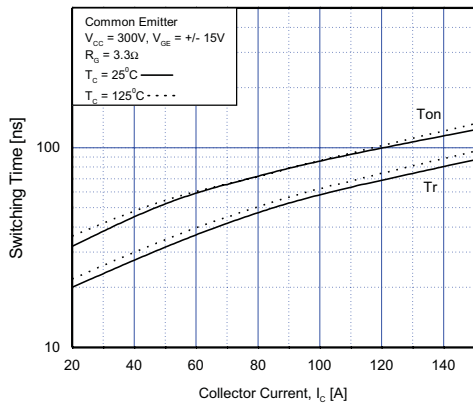

Fig 11. Turn-On Characteristics vs. Collector Current

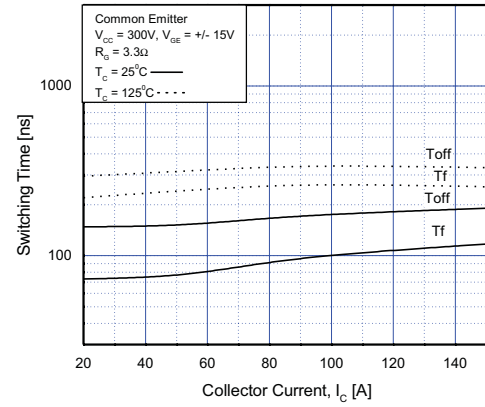

Fig 12. Turn-Off Characteristics vs. Collector Current

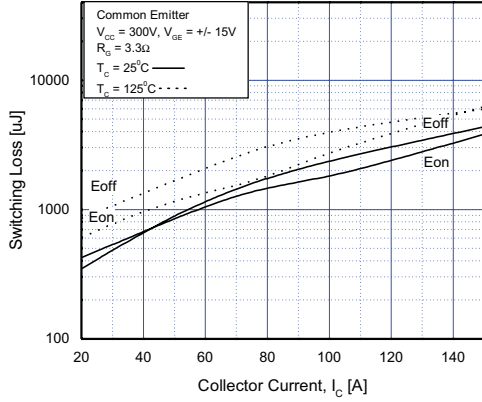

Fig 13. Switching Loss vs. Collector Current

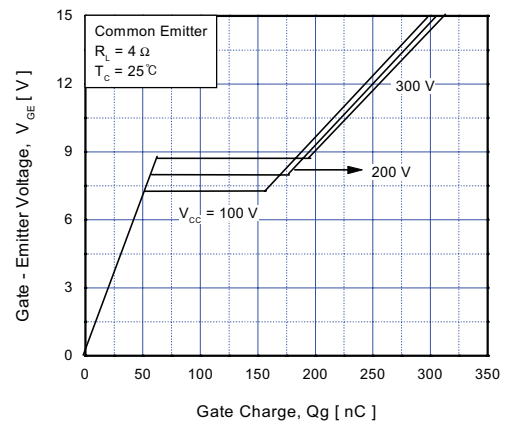

Fig 14. Gate Charge Characteristics

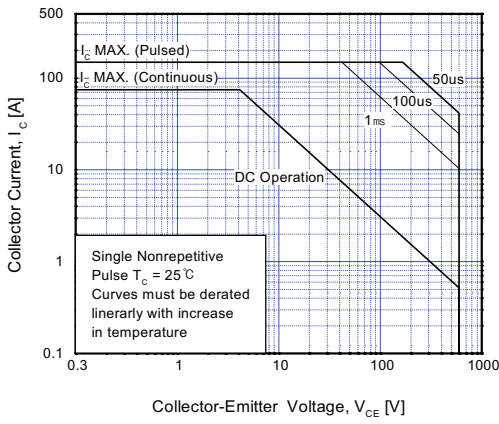

Fig 15. SOA Characteristics

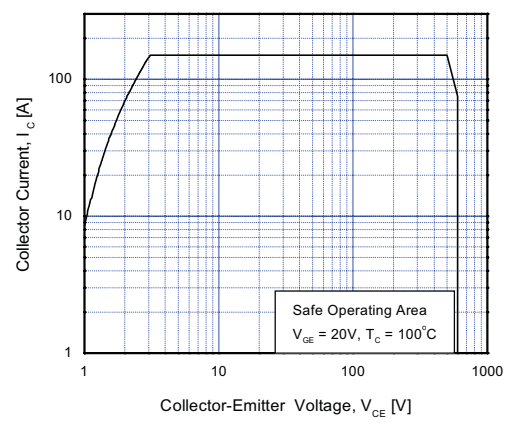

Fig 16. Turn-Off SOA Characteristics

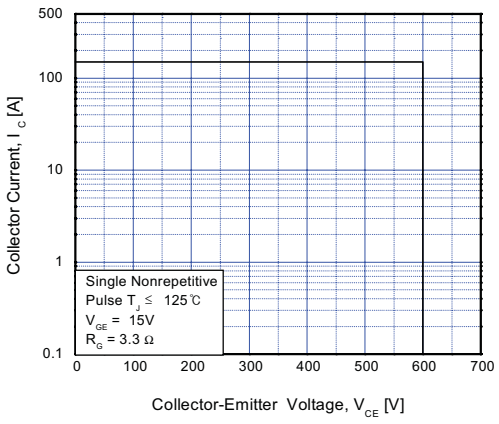

Fig 17. RBSOA Characteristics

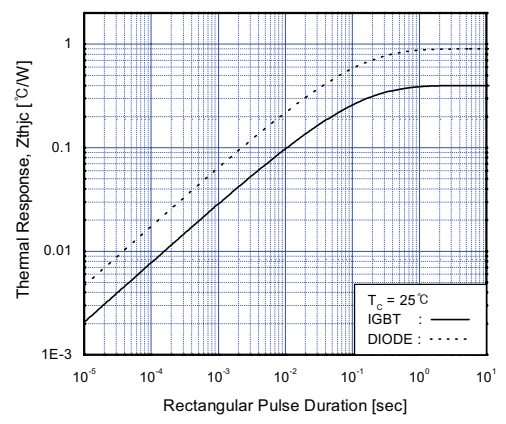

Fig 18. Transient Thermal Impedance

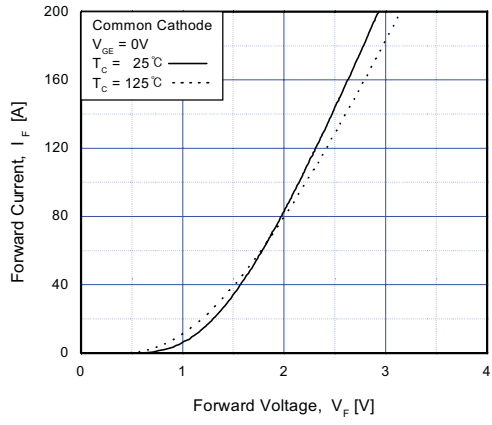

Fig 19. Forward Characteristics

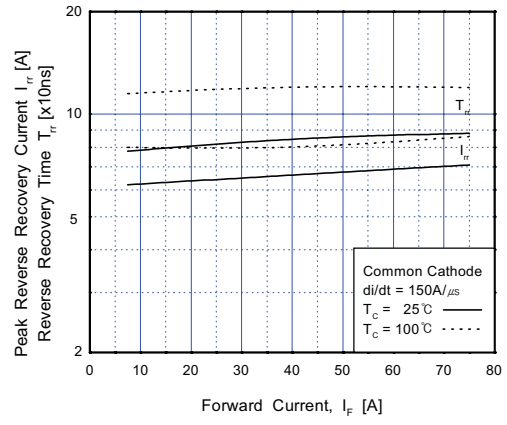
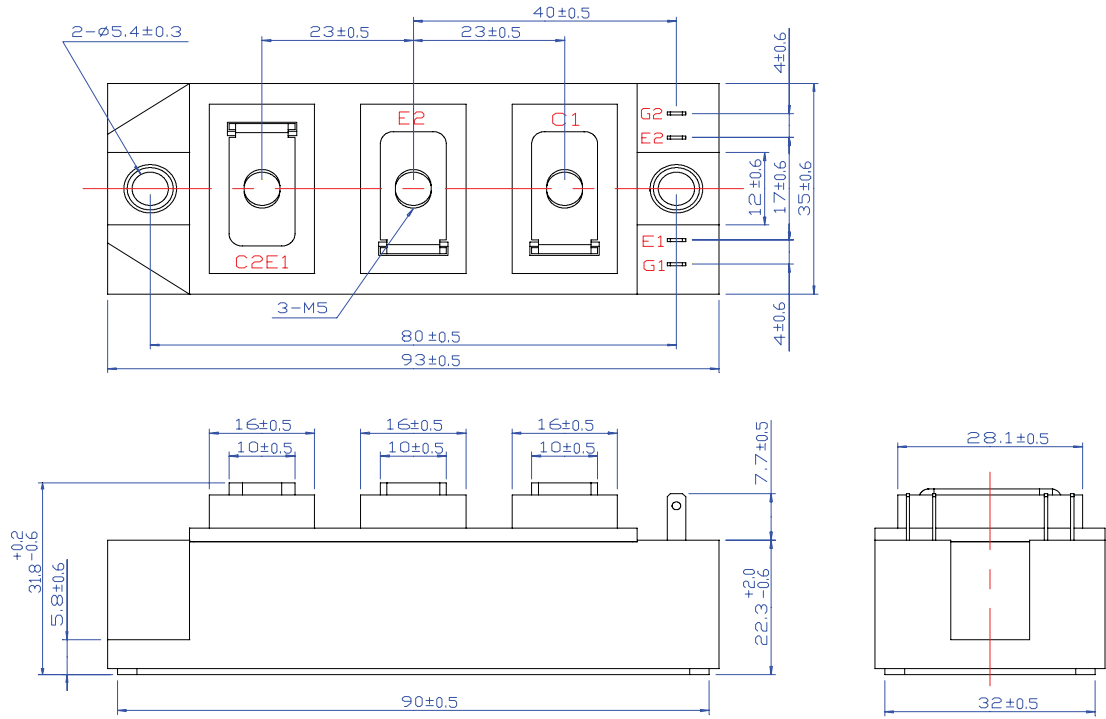

Fig 20. Reverse Recovery Characteristics

# Package Dimension

## 7PM-GA

FMG2G75US60



Dimensions in Millimeters

## TRADEMARKS

The following are registered and unregistered trademarks Fairchild Semiconductor owns or is authorized to use and is not intended to be an exhaustive list of all such trademarks.

|                       |                     |                     |                 |      |
|-----------------------|---------------------|---------------------|-----------------|------|
| ACEx™                 | FAST®               | OPTOLOGIC™          | SMART START™    | VCX™ |
| Bottomless™           | FASTr™              | OPTOPLANAR™         | STAR*POWER™     |      |
| CoolFET™              | FRFET™              | PACMAN™             | Stealth™        |      |
| CROSSVOLT™            | GlobalOptoisolator™ | POP™                | SuperSOT™-3     |      |
| DenseTrench™          | GTO™                | Power247™           | SuperSOT™-6     |      |
| DOME™                 | HiSeC™              | PowerTrench®        | SuperSOT™-8     |      |
| EcoSPARK™             | ISOPLANAR™          | QFET™               | SyncFET™        |      |
| E <sup>2</sup> C MOS™ | LittleFET™          | QS™                 | TruTranslation™ |      |
| EnSigna™              | MicroFET™           | QT Optoelectronics™ | TinyLogic™      |      |
| FACT™                 | MicroPak™           | Quiet Series™       | UHC™            |      |
| FACT Quiet Series™    | MICROWIRE™          | SLIENT SWITCHER®    | UltraFET®       |      |

STAR\*POWER is used under license

## DISCLAIMER

FAIRCHILD SEMICONDUCTOR RESERVES THE RIGHT TO MAKE CHANGES WITHOUT FURTHER NOTICE TO ANY PRODUCTS HEREIN TO IMPROVE RELIABILITY, FUNCTION OR DESIGN. FAIRCHILD DOES NOT ASSUME ANY LIABILITY ARISING OUT OF THE APPLICATION OR USE OF ANY PRODUCT OR CIRCUIT DESCRIBED HEREIN; NEITHER DOES IT CONVEY ANY LICENSE UNDER ITS PATENT RIGHTS, NOR THE RIGHTS OF OTHERS.

## LIFE SUPPORT POLICY

FAIRCHILD'S PRODUCTS ARE NOT AUTHORIZED FOR USE AS CRITICAL COMPONENTS IN LIFE SUPPORT DEVICES OR SYSTEMS WITHOUT THE EXPRESS WRITTEN APPROVAL OF FAIRCHILD SEMICONDUCTOR INTERNATIONAL.

As used herein:

1. Life support devices or systems are devices or systems which, (a) are intended for surgical implant into the body, or (b) support or sustain life, or (c) whose failure to perform when properly used in accordance with instructions for use provided in the labeling, can be reasonably expected to result in significant injury to the user.
2. A critical component is any component of a life support device or system whose failure to perform can be reasonably expected to cause the failure of the life support device or system, or to affect its safety or effectiveness.

## PRODUCT STATUS DEFINITIONS

### Definition of Terms

| Datasheet Identification | Product Status         | Definition  |
|--------------------------|------------------------|---|
| Advance Information      | Formative or In Design | This datasheet contains the design specifications for product development. Specifications may change in any manner without notice.  |
| Preliminary              | First Production       | This datasheet contains preliminary data, and supplementary data will be published at a later date. Fairchild Semiconductor reserves the right to make changes at any time without notice in order to improve design. |
| No Identification Needed | Full Production        | This datasheet contains final specifications. Fairchild Semiconductor reserves the right to make changes at any time without notice in order to improve design.   |
| Obsolete                 | Not In Production      | This datasheet contains specifications on a product that has been discontinued by Fairchild semiconductor. The datasheet is printed for reference information only.   |

## Looking for pricing, stock, or lifecycle information?

Click below to explore more details on WIN SOURCE:

- ⊖ [View FMG2G75US60 on WIN SOURCE](#)
- ⊖ [Fairchild/ON Semiconductor Information](#)

## Optimize Your Supply Chain with WIN SOURCE Solutions

- ✓ Global Sourcing Solution
- ✓ Obsolete Management
- ✓ Cost Control Management
- ✓ Shortage Management
- ✓ Alternative Solution
- ✓ Excess Inventory Management