



THE DATASHEET OF ADM208EARZ-REEL





ADM206E/ADM207E/ADM208E/ADM211E/ADM213E

FEATURES

Complies with 89/336/EEC EMC directive

ESD protection to IEC 1000-4-2 (801-2)

Contact discharge: ±8 kV

Air-gap discharge: ±15 kV

Human body model: ±15 kV

EFT/burst immunity (IEC 1000-4-4)

Low EMI emissions (EN 55022)

Eliminates need for TransZorb® suppressors

230 kbps data rate guaranteed

Single 5 V power supply

Shutdown mode 1 μW

Plug-in upgrade for MAX2xxE

Space saving TSSOP package available

APPLICATIONS

Laptop computers

Notebook computers

Printers

Peripherals

Modems

GENERAL DESCRIPTION

The ADM2xxE is a family of robust RS-232 and V.28 interface devices that operate from a single 5 V power supply. These products are suitable for operation in harsh electrical environments and are compliant with the EU directive on electromagnetic compatibility (EMC) (89/336/EEC). The level of emissions and immunity are both in compliance. EM immunity includes ESD protection in excess of ±15 kV on all I/O lines (IEC 1000-4-2), fast transient burst protection (IEC 1000-4-4), and radiated immunity (IEC 1000-4-3). EM emissions include radiated and conducted emissions as required by Information Technology Equipment EN 55022, CISPR 22.

All devices fully conform to the EIA-232-E and CCITT V.28 specifications and operate at data rates up to 230 kbps. Shutdown and enable control pins are provided on some of the products (see Table 1).

The shutdown function on the ADM211E disables the charge pump and all transmitters and receivers. On the ADM213E the



1 INTERNAL 400kΩ PULL-UP RESISTOR ON EACH TTL/CMOS INPUT.
2 INTERNAL 5kΩ PULL-DOWN RESISTOR ON EACH RS-232 INPUT.

Figure 1.

charge pump, all transmitters, and three of the five receivers are disabled. The remaining two receivers remain active, thereby allowing monitoring of peripheral devices. This feature allows the device to be shut down until a peripheral device begins communication. The active receivers can alert the processor, which can then take the ADM213E out of the shutdown mode.

Operating from a single 5 V supply, four external 0.1 μF capacitors are required.

The ADM207E and ADM208E are available in 24-lead PDIP, SSOP, available in 28-lead SSOP, TSSOP, and SOIC_W packages. All products are backward compatible with earlier ADM2xx products, facilitating easy upgrading of older designs.

Table 1. Selection Table

Model	Supply Voltage	Drivers	Receivers	ESD Protection	Shutdown	Enable	Packages
ADM206E	5 V	4	3	±15 kV	Yes	Yes	RW-24
ADM207E	5 V	5	3	±15 kV	No	No	N-24-1, RW-24, RS-24, RU-24
ADM208E	5 V	4	4	±15 kV	No	No	N-24-1, RW-24, RS-24, RU-24
ADM211E	5 V	4	5	±15 kV	Yes	Yes	RW-28, RS-28, RU-28
ADM213E	5 V	4	5	±15 kV	Yes (SHDN) ¹	Yes (EN)	RW-28, RS-28, RU-28

¹ Two receivers active.

Rev. E

Information furnished by Analog Devices is believed to be accurate and reliable. However, no responsibility is assumed by Analog Devices for its use, nor for any infringements of patents or other rights of third parties that may result from its use. Specifications subject to change without notice. No license is granted by implication or otherwise under any patent or patent rights of Analog Devices. Trademarks and registered trademarks are the property of their respective owners.

TABLE OF CONTENTS

Features	1	Enable and Shutdown	10
Applications.....	1	High Baud Rate.....	11
General Description	1	ESD/EFT Transient Protection Scheme	11
Connection Diagram	1	ESD Testing (IEC 1000-4-2)	11
Revision History	2	EFT/Burst Testing (IEC 1000-4-4).....	12
Specifications.....	3	IEC 1000-4-3 Radiated Immunity	13
Absolute Maximum Ratings.....	4	Emissions/Interference.....	14
ESD Caution.....	4	Conducted Emissions	14
Pin Configurations and Function Descriptions	5	Radiated Emissions	14
Typical Performance Characteristics	8	Outline Dimensions	16
Theory of Operation	10	Ordering Guide	19
Circuit Description.....	10		

REVISION HISTORY

9/06—Rev. D to Rev. E

Updated Format	Universal
Changes to Figure 1 and Table 1	1
Changes to Table 2.....	3
Changes to Figure 2, Figure 3, and Figure 5.....	5
Changes to Figure 7 and Figure 9.....	6
Changes to Figure 11	7
Changes to Figure 17.....	8
Updated Outline Dimensions	16
Changes to Ordering Guide	19

4/05—Rev. C to Rev. D

Changes to Specifications Section	2
Changes to Ordering Guide	4
Updated Outline Dimensions	6

3/01—Rev. B to Rev. C

Changes to Features Section	1
Changes to Specifications Table	2
Changes to Absolute Maximum Ratings.....	3
Changes to Figure 6	5
Changes to Typical Performance Characteristics Section	7, 8
Changes to Table V.....	11

ADM206E/ADM207E/ADM208E/ADM211E/ADM213E

SPECIFICATIONS

$V_{CC} = 5.0\text{ V} \pm 10\%$, C1 to C4 = 0.1 μF . All specifications T_{MIN} to T_{MAX} , unless otherwise noted.

Table 2.

Parameter	Min	Typ	Max	Unit	Test Conditions/Comments
DC CHARACTERISTICS					
Operating Voltage Range	4.5	5.0	5.5	V	
V_{CC} Power Supply Current		3.5	13	mA	No load
SHUTDOWN SUPPLY CURRENT					
		0.2	10	μA	
LOGIC					
Input Pull-Up Current		10	25	μA	$T_{IN} = \text{GND}$
Input Logic Threshold Low, V_{INL}			0.8	V	$T_{IN}, \overline{\text{EN}}, \overline{\text{SHDN}}, \overline{\text{SHDN}}$
Input Logic Threshold High, V_{INH}	2.0			V	T_{IN}
Input Logic Threshold High, V_{INH}	2.0			V	$\overline{\text{EN}}, \overline{\text{SHDN}}, \overline{\text{SHDN}}$
TTL/CMOS Output Voltage Low, V_{OL}			0.4	V	$I_{OUT} = 1.6\text{ mA}$
TTL/CMOS Output Voltage High, V_{OH}	3.5			V	$I_{OUT} = -40\text{ }\mu\text{A}$
TTL/CMOS Output Leakage Current		+0.05	± 10	μA	$\overline{\text{EN}} = V_{CC}, \text{EN} = \text{GND}, 0\text{ V} \leq R_{OUT} \leq V_{CC}$
RS-232 RECEIVER					
Input Voltage Range ¹	-30		+30	V	
Input Threshold Low	0.8	1.3		V	
Input Threshold High		2.0	2.4	V	
Input Hysteresis		0.65		V	
Input Resistance	3	5	7	k Ω	$T_A = 0^\circ\text{C to } 85^\circ\text{C}$
RS-232 TRANSMITTER					
Output Voltage Swing	± 5.0	± 9.0		V	All transmitter outputs loaded with 3 k Ω to ground
Output Resistance	300			Ω	$V_{CC} = 0\text{ V}, V_{OUT} = \pm 2\text{ V}$
Output Short-Circuit Current	± 6	± 20	± 60	mA	
TIMING CHARACTERISTICS					
Maximum Data Rate	230			kbps	$R_L = 3\text{ k}\Omega\text{ to } 7\text{ k}\Omega, C_L = 50\text{ pF to } 2500\text{ pF}$
Receiver Propagation Delay, T _{PHL} , T _{PLH}		0.4	2	μs	$C_L = 150\text{ pF}$
Receiver Output Enable Time, t _{ER}		120		ns	
Receiver Output Disable Time, t _{DR}		120		ns	
Transmitter Propagation Delay, T _{PHL} , T _{PLH}		1		μs	$R_L = 3\text{ k}\Omega, C_L = 2500\text{ pF}$
Transition Region Slew Rate		8		V/ μs	$R_L = 3\text{ k}\Omega, C_L = 50\text{ pF to } 2500\text{ pF}$, measured from +3 V to -3 V or -3 V to +3 V
EM IMMUNITY					
ESD Protection (I/O Pins)		± 15		kV	Human body model
		± 15		kV	IEC 1000-4-2 air-gap discharge
		± 8		kV	IEC 1000-4-2 contact discharge
Radiated Immunity		10		V/m	IEC 1000-4-3

¹ Guaranteed by design.

Table 3. ADM211E Truth Table

SHDN	$\overline{\text{EN}}$	Status	T _{OUT 1:4}	R _{OUT 1:5}
0	0	Normal operation	Enabled	Enabled
0	1	Normal operation	Enabled	Disabled
1	X ¹	Shutdown	Disabled	Disabled

¹X = don't care.

Table 4. ADM213E Truth Table

SHDN	EN	Status	T _{OUT 1:4}	R _{OUT 1:3}	R _{OUT 4:5}
0	0	Shutdown	Disabled	Disabled	Disabled
0	1	Shutdown	Disabled	Disabled	Enabled
1	0	Normal operation	Enabled	Disabled	Disabled
1	1	Normal operation	Enabled	Enabled	Enabled

ADM206E/ADM207E/ADM208E/ADM211E/ADM213E

ABSOLUTE MAXIMUM RATINGS

T_A = 25°C, unless otherwise noted.

Table 5.

Parameter	Rating
V _{CC}	−0.3 V to +6 V
V+	(V _{CC} − 0.3 V) to +14 V
V−	+0.3 V to −14 V
Input Voltages	
T _{IN}	−0.3 V to (V+ + 0.3 V)
R _{IN}	±30 V
Output Voltages	
T _{OUT}	±15 V
R _{OUT}	−0.3 V to (V _{CC} + 0.3 V)
Short-Circuit Duration	
T _{OUT}	Continuous
Power Dissipation	
N-24-1 PDIP (Derate 13.5 mW/°C above 70°C)	1000 mW
RW-24 SOIC_W (Derate 12 mW/°C above 70°C)	900 mW
RS-24 SSOP (Derate 12 mW/°C above 70°C)	850 mW
RU-24 TSSOP (Derate 12 mW/°C above 70°C)	900 mW
RW-28 SOIC_W (Derate 12 mW/°C above 70°C)	900 mW
RS-28 SSOP (Derate 10 mW/°C above 70°C)	900 mW
RU-28 TSSOP (Derate 12 mW/°C above 70°C)	900 mW
Operating Temperature Range	−40°C to +85°C
Storage Temperature Range	−65°C to +150°C
Lead Temperature, Soldering (10 sec)	300°C
ESD Rating	
MIL-STD-883B (I/O Pins)	±15 kV
IEC 1000-4-2 Air-Gap (I/O Pins)	±15 kV
IEC 1000-4-2 Contact (I/O Pins)	±8 kV

Stresses above those listed under Absolute Maximum Ratings may cause permanent damage to the device. This is a stress rating only; functional operation of the device at these or any other conditions above those indicated in the operational section of this specification is not implied. Exposure to absolute maximum rating conditions for extended periods may affect device reliability.

ESD CAUTION



ESD (electrostatic discharge) sensitive device. Charged devices and circuit boards can discharge without detection. Although this product features patented or proprietary protection circuitry, damage may occur on devices subjected to high energy ESD. Therefore, proper ESD precautions should be taken to avoid performance degradation or loss of functionality.

PIN CONFIGURATIONS AND FUNCTION DESCRIPTIONS



Figure 2. ADM206E Pin Configuration



Figure 4. ADM207E Pin Configuration



¹INTERNAL 400kΩ PULL-UP RESISTOR ON EACH TTL/CMOS INPUT.
²INTERNAL 5kΩ PULL-DOWN RESISTOR ON EACH RS-232 INPUT.

Figure 3. ADM206E Typical Operating Circuit



¹INTERNAL 400kΩ PULL-UP RESISTOR ON EACH TTL/CMOS INPUT.
²INTERNAL 5kΩ PULL-DOWN RESISTOR ON EACH RS-232 INPUT.

Figure 5. ADM207E Typical Operating Circuit

ADM206E/ADM207E/ADM208E/ADM211E/ADM213E



Figure 6. ADM208E Pin Configuration



Figure 8. ADM211E Pin Configuration



- ¹INTERNAL 400kΩ PULL-UP RESISTOR ON EACH TTL/CMOS INPUT.
- ²INTERNAL 5kΩ PULL-DOWN RESISTOR ON EACH RS-232 INPUT.

Figure 7. ADM208E Typical Operating Circuit



- ¹INTERNAL 400kΩ PULL-UP RESISTOR ON EACH TTL/CMOS INPUT.
- ²INTERNAL 5kΩ PULL-DOWN RESISTOR ON EACH RS-232 INPUT.

Figure 9. ADM211E Typical Operating Circuit

00088-007

00088-009

ADM206E/ADM207E/ADM208E/ADM211E/ADM213E



Figure 10. ADM213E Pin Configuration

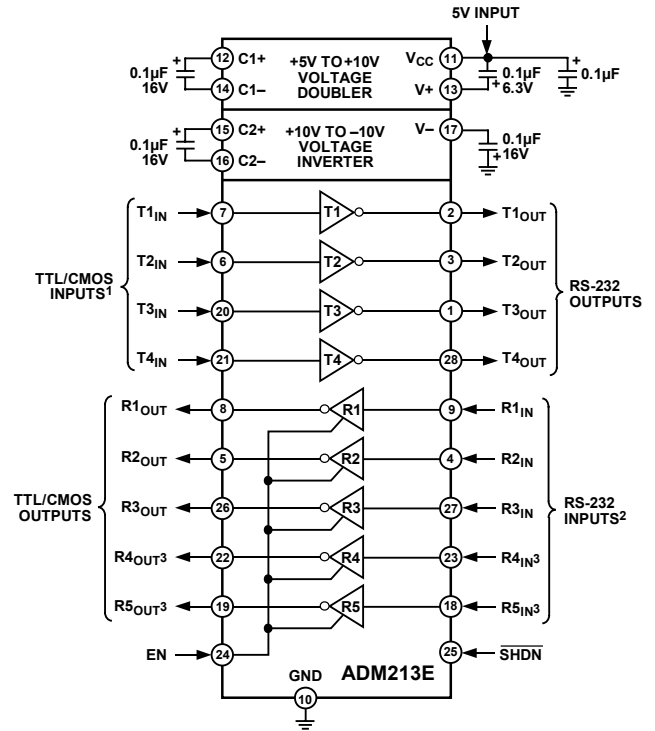

- ¹INTERNAL 400kΩ PULL-UP RESISTOR ON EACH TTL/CMOS INPUT.
- ²INTERNAL 5kΩ PULL-DOWN RESISTOR ON EACH RS-232 INPUT.
- ³ACTIVE IN SHUTDOWN.

Figure 11. ADM213E Typical Operating Circuit

Table 6. Pin Function Descriptions

Mnemonic	Function
V _{CC}	Power Supply Input (5 V ± 10%).
V+	Internally Generated Positive Supply (+9 V nominal).
V-	Internally Generated Negative Supply (-9 V nominal).
GND	Ground Pin. Must be connected to 0 V.
C1+, C1-	External Capacitor 1 is connected between these pins. A 0.1 μF capacitor is recommended, but larger capacitors (up to 47 μF) can be used.
C2+, C2-	External Capacitor 2 is connected between these pins. A 0.1 μF capacitor is recommended, but larger capacitors (up to 47 μF) can be used.
T _{IN}	Transmitter (Driver) Inputs. These inputs accept TTL/CMOS levels. An internal 400 kΩ pull-up resistor to V _{CC} is connected on each input.
T _{OUT}	Transmitter (Driver) Outputs. These are RS-232 signal levels (typically ±9 V).
R _{IN}	Receiver Inputs. These inputs accept RS-232 signal levels. An internal 5 kΩ pull-down resistor to GND is connected on each input.
R _{OUT}	Receiver Outputs. These are TTL/CMOS output logic levels.
EN/ <u>EN</u>	Receiver Enable (active high on ADM213E, active low on ADM211E). This input is used to enable/disable the receiver outputs. With <u>EN</u> = low for the ADM211E (EN = high for the ADM213E), the receiver outputs are enabled. With EN = high for the ADM211E (EN = low for the ADM213E), the receiver outputs are placed in a high impedance state. (See Table 3 and Table 4.)
<u>SHDN</u> /SHDN	Shutdown Control (active low on ADM213E, active high on ADM211E). When the ADM211E is in shutdown, the charge pump is disabled, the transmitter outputs are turned off, and all receiver outputs are placed in a high impedance state. When the ADM213E is in shutdown, the charge pump is disabled, the transmitter outputs are turned off, and Receiver R1 to Receiver R3 are placed in a high impedance state; Receiver R4 and Receiver R5 on the ADM213E continue to operate normally during shutdown. (See Table 3 and Table 4.) Power consumption for all parts reduces to 5 μW in shutdown.

TYPICAL PERFORMANCE CHARACTERISTICS



Figure 12. EMC Conducted Emissions



Figure 15. EMC Radiated Emissions

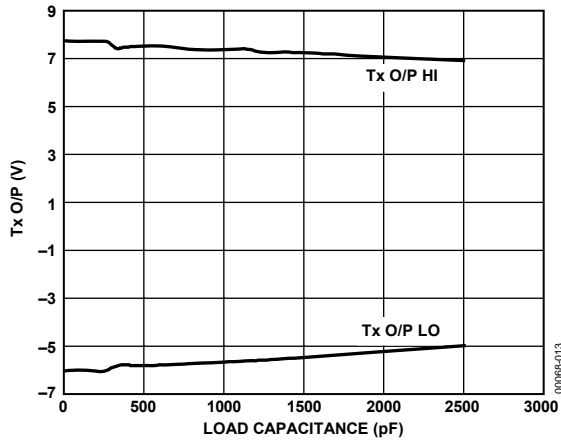

Figure 13. Transmitter Output Voltage High/Low vs. Load Capacitance (230 kbps)



Figure 16. Transmitter Output Voltage vs. Power Supply Voltage



Figure 14. Transmitter Output Voltage vs. Load Current



Figure 17. Charge Pump V+, V- Exiting Shutdown



Figure 18. Charge Pump Impedance vs. Power Supply Voltage



Figure 19. Charge Pump V⁺, V⁻ vs. Load Current

THEORY OF OPERATION

The ADM206E/ADM207E/ADM208E/ADM211E/ADM213E are ruggedized RS-232 line drivers/receivers that operate from a single 5 V supply. Step-up voltage converters coupled with level shifting transmitters and receivers allow RS-232 levels to be developed while operating from a single 5 V supply.

Features include low power consumption, high transmission rates, and compliance with the EU directive on EMC, which includes protection against radiated and conducted interference, including high levels of electrostatic discharge.

All RS-232 inputs and outputs contain protection against electrostatic discharges up to ± 15 kV and electrical fast transients up to ± 2 kV. This ensures compliance to IEC 1000-4-2 and IEC 1000-4-4 requirements.

The devices are ideally suited for operation in electrically harsh environments or where RS-232 cables are plugged/unplugged frequently. They are also immune to high RF field strengths without special shielding precautions.

Emissions are also controlled to within very strict limits. TTL/CMOS technology is used to keep the power dissipation to an absolute minimum, allowing maximum battery life in portable applications. The ADM2xxE is a modification, enhancement, and improvement to the ADM2xx family and its derivatives. It is essentially plug-in compatible and does not have materially different applications.

CIRCUIT DESCRIPTION

The internal circuitry consists of four main sections:

- A charge pump voltage converter.
- 5 V logic to EIA-232 transmitters.
- EIA-232 to 5 V logic receivers.
- Transient protection circuit on all I/O lines.

Charge Pump DC-to-DC Voltage Converter

The charge pump voltage converter consists of a 200 kHz oscillator and a switching matrix. The converter generates a ± 10 V supply from the input 5 V level. This is done in two stages using a switched capacitor technique as illustrated in Figure 20 and Figure 21. First, the 5 V input supply is doubled to 10 V using Capacitor C1 as the charge storage element. The 10 V level is then inverted to generate -10 V using C2 as the storage element.

Capacitor C3 and Capacitor C4 are used to reduce the output ripple. If desired, larger capacitors (up to 47 μ F) can be used for Capacitor C1 to Capacitor C4. This facilitates direct substitution with older generation charge pump RS-232 transceivers.

The V+ and V- supplies can also be used to power external circuitry, if the current requirements are small (see the Typical Performance Characteristics section).

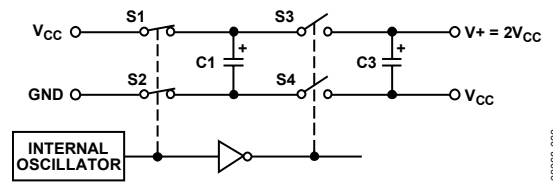

Figure 20. Charge Pump Voltage Doubler

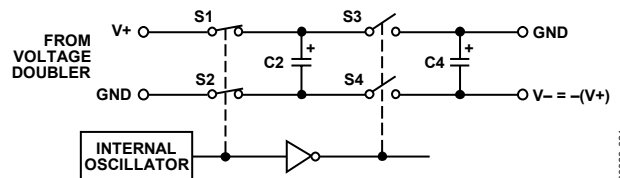

Figure 21. Charge Pump Voltage Inverter

Transmitter (Driver) Section

The drivers convert 5 V logic input levels into EIA-232 output levels. With $V_{CC} = 5$ V and driving an EIA-232 load, the output voltage swing is typically ± 9 V.

Unused inputs can be left unconnected, as an internal 400 k Ω pull-up resistor pulls them high, forcing the outputs into a low state. The input pull-up resistors typically source 8 μ A when grounded, so unused inputs should either be connected to V_{CC} or left unconnected in order to minimize power consumption.

Receiver Section

The receivers are inverting level shifters that accept EIA-232 input levels and translate them into 5 V logic output levels. The inputs have internal 5 k Ω pull-down resistors to ground and are protected against overvoltages of up to ± 25 V. The guaranteed switching thresholds are 0.4 V minimum and 2.4 V maximum. Unconnected inputs are pulled to 0 V by the internal 5 k Ω pull-down resistor. This, therefore, results in a Logic 1 output level for unconnected inputs or for inputs connected to GND.

The receivers have Schmitt trigger inputs with a hysteresis level of 0.65 V. This ensures error-free reception for both noisy inputs and for inputs with slow transition times.

ENABLE AND SHUTDOWN

Table 3 and Table 4 are truth tables for the enable and shutdown control signals. The enable function is intended to facilitate data bus connections where it is desirable to tristate the receiver outputs. In the disabled mode, all receiver outputs are placed in a high impedance state. The shutdown function is intended to shut down the device, thereby minimizing the quiescent current. In shutdown, all transmitters are disabled and all receivers on the ADM211E are tristated.

On the ADM213E, Receiver R4 and Receiver R5 remain enabled in shutdown. Note that the transmitters are disabled but are not tristated in shutdown; it is not permitted to connect multiple (RS-232) driver outputs together.

The shutdown feature is very useful in battery-operated systems since it reduces the power consumption to 1 μ W. During shutdown, the charge pump is also disabled. The shutdown control input is active high on the ADM211E, and it is active low on the ADM213E. When exiting shutdown, the charge pump is restarted, and it takes approximately 100 μ s for it to reach its steady state operating condition.

HIGH BAUD RATE

The ADM2xxE feature high slew rates, permitting data transmission rates well in excess of the EIA-232-E specifications. RS-232 levels are maintained at data rates up to 230 kbps, even under worst-case loading conditions. This allows for high speed data links between two terminals, making it suitable for the new generation modem standards that require data rates of 200 kbps. The slew rate is controlled internally to less than 30 V/ μ s to minimize EMI interference.



NOTES
1. EN IS THE COMPLEMENT OF $\overline{\text{EN}}$ FOR THE ADM213E.

Figure 22. Receiver Disable Timing

00088-022

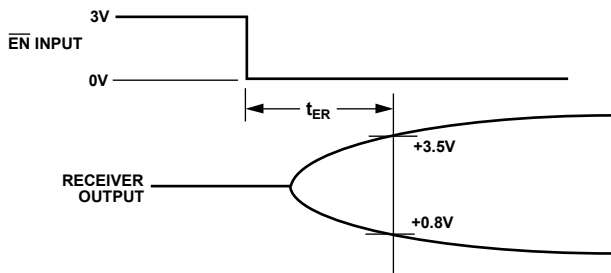

NOTES
1. EN IS THE COMPLEMENT OF $\overline{\text{EN}}$ FOR THE ADM213E.

Figure 23. Receiver Enable Timing

00088-023

ESD/EFT TRANSIENT PROTECTION SCHEME

The ADM2xxE use protective clamping structures on all inputs and outputs that clamp the voltage to a safe level and dissipate the energy present in ESD (electrostatic) and EFT (electrical fast transient) discharges. A simplified schematic of the

protection structure is shown in Figure 24 and Figure 25. Each input and output contains two back-to-back high speed clamping diodes. During normal operation, with maximum RS-232 signal levels, the diodes have no effect because one or the other is reverse biased, depending on the polarity of the signal. If, however, the voltage exceeds about ± 50 V, reverse breakdown occurs, and the voltage is clamped at this level. The diodes are large p-n junctions designed to handle the instantaneous current surges that can exceed several amperes.

The transmitter outputs and receiver inputs have a similar protection structure. The receiver inputs can also dissipate some of the energy through the internal 5 k Ω resistor to GND as well as through the protection diodes.

The protection structure achieves ESD protection up to ± 15 kV and EFT protection up to ± 2 kV on all RS-232 I/O lines. The methods used to test the protection scheme are discussed in the ESD Testing (IEC 1000-4-2) and EFT/Burst Testing (IEC 1000-4-4) sections.



Figure 24. Receiver Input Protection Scheme

00088-024

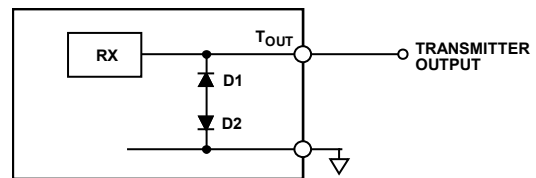

Figure 25. Transmitter Output Protection Scheme

00088-025

ESD TESTING (IEC 1000-4-2)

IEC 1000-4-2 (previously IEC 801-2) specifies compliance testing using two coupling methods, contact discharge and air-gap discharge. Contact discharge calls for a direct connection to the unit being tested. Air-gap discharge uses a higher test voltage but does not make direct contact with the unit under test. With air-gap discharge, the discharge gun is moved toward the unit under test, developing an arc across the air gap. This method is influenced by humidity, temperature, barometric pressure, distance, and rate of closure of the discharge gun. The contact discharge method, while less realistic, is more repeatable and is gaining acceptance in preference to the air-gap method.

Although very little energy is contained within an ESD pulse, the extremely fast rise time, coupled with high voltages, can cause failures in unprotected semiconductors. Catastrophic

ADM206E/ADM207E/ADM208E/ADM211E/ADM213E

destruction can occur immediately because of arcing or heating. Even if catastrophic failure does not occur immediately, the device can suffer from parametric degradation that can result in degraded performance. The cumulative effects of continuous exposure can eventually lead to complete failure.

I/O lines are particularly vulnerable to ESD damage. Simply touching or plugging in an I/O cable can result in a static discharge that can damage or destroy the interface product connected to the I/O port. Traditional ESD test methods, such as the MIL-STD-883B method 3015.7, do not fully test product susceptibility to this type of discharge. This test was intended to test product susceptibility to ESD damage during handling. Each pin is tested with respect to all other pins.

There are some important differences between the traditional test and the IEC test:

- The IEC test is much more stringent in terms of discharge energy. The peak current injected is over four times greater.
- The current rise time is significantly faster in the IEC test.
- The IEC test is carried out while power is applied to the device.

It is possible that the ESD discharge could induce latch-up in the device being tested. This test, therefore, is more representative of a real-world I/O discharge, where the equipment is operating normally with power applied. However, both tests should be performed to ensure maximum protection both during handling and later during field service.



Figure 26. ESD Test Standards



Figure 27. Human Body Model ESD Current Waveform

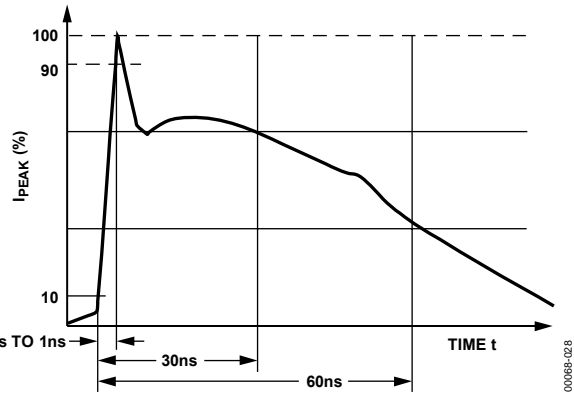

Figure 28. IEC 1000-4-2 ESD Current Waveform

ADM2xxE products are tested using both of the previously mentioned test methods. Pins are tested with respect to all other pins as per the MIL-STD-883B specification. In addition, all I/O pins are tested per the IEC test specification. The products are tested under the following conditions:

- Power on (normal operation).
- Power on (shutdown mode).
- Power off.

There are four levels of compliance defined by IEC 1000-4-2. ADM2xxE products meet the most stringent compliance level both for contact and for air-gap discharge. This means that the products are able to withstand contact discharges in excess of 8 kV and air-gap discharges in excess of 15 kV.

Table 7. IEC 1000-4-2 Compliance Levels

Level	Contact Discharge (kV)	Air-Gap Discharge (kV)
1	2	2
2	4	4
3	6	8
4	8	15

Table 8. ADM2xxE ESD Test Results

ESD Test Method	I/O Pin (kV)
MIL-STD-883B	±15
IEC 1000-4-2	
Contact	±8
Air-Gap	±15

EFT/BURST TESTING (IEC 1000-4-4)

IEC 1000-4-4 (previously IEC 801-4) covers EFT/burst immunity. Electrical fast transients occur because of arcing contacts in switches and relays. The tests simulate the interference generated when, for example, a power relay disconnects an inductive load. A spark is generated due to the well-known back EMF effect. In fact, the spark consists of a

burst of sparks as the relay contacts separate. The voltage appearing on the line, therefore, consists of a burst of extremely fast transient impulses. A similar effect occurs when switching on fluorescent lights.

The fast transient burst test defined in IEC 1000-4-4 simulates this arcing; its waveform is illustrated in Figure 29. It consists of a burst of 2.5 kHz to 5 kHz transients repeating at 300 ms intervals. It is specified for both power and data lines.

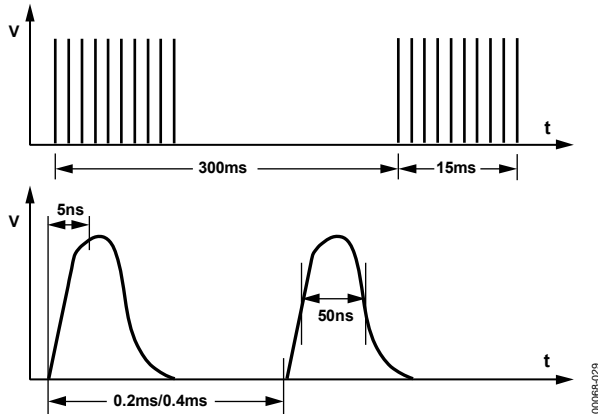

Figure 29. IEC 1000-4-4 Fast Transient Waveform

Table 9.

Level	V Peak (kV) PSU	V Peak (kV) I/O
1	0.5	0.25
2	1	0.5
3	2	1
4	4	2

A simplified circuit diagram of the actual EFT generator is illustrated in Figure 30.

The transients are coupled onto the signal lines using an EFT coupling clamp. The clamp is 1 m long and surrounds the cable completely, providing maximum coupling capacitance (50 pF to 200 pF typical) between the clamp and the cable. High energy transients are capacitively coupled onto the signal lines. Fast rise times (5 ns), as specified by the standard, result in very effective coupling. Because high voltages are coupled onto the signal lines, this test is very severe. The repetitive transients can often cause problems where single pulses do not. Destructive latch-up can be induced due to the high energy content of the transients. Note that this stress is applied while the interface products are powered up and are transmitting data. The EFT test applies hundreds of pulses with higher energy than ESD. Worst-case transient current on an I/O line can be as high as 40 A.

Test results are classified according to the following:

- Classification 1: Normal performance within specification limits.
- Classification 2: Temporary degradation or loss of performance that is self recoverable.

- Classification 3: Temporary degradation or loss of function or performance that requires operator intervention or system reset.
- Classification 4: Degradation or loss of function that is not recoverable due to damage.

ADM2xxE products meet Classification 2 and have been tested under worst-case conditions using unshielded cables. Data transmission during the transient condition is corrupted, but it can resume immediately following the EFT event without user intervention.

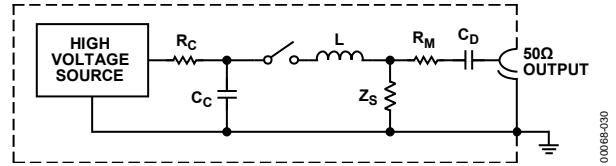

Figure 30. IEC 1000-4-4 Fast Transient Generator

IEC 1000-4-3 RADIATED IMMUNITY

IEC 1000-4-3 (previously IEC 801-3) describes the measurement method and defines the levels of immunity to radiated electromagnetic fields. It was originally intended to simulate the electromagnetic fields generated by portable radio transceivers or any other devices that generate continuous wave-radiated EM energy. Its scope has since been broadened to include spurious EM energy that can be radiated from fluorescent lights, thyristor drives, inductive loads, and other sources.

Testing for immunity involves irradiating the device with an EM field. There are various methods of achieving this, including use of anechoic chamber, stripline cell, TEM cell, and GTEM cell. A stripline cell consists of two parallel plates with an electric field developed between them. The device under test is placed within the cell and exposed to the electric field. There are three severity levels having field strengths ranging from 1 V/m to 10 V/m. Results are classified in a similar fashion to those for IEC 1000-4-4.

- Classification 1: Normal operation.
- Classification 2: Temporary degradation or loss of function that is self recoverable when the interfering signal is removed.
- Classification 3: Temporary degradation or loss of function that requires operator intervention or system reset when the interfering signal is removed.
- Classification 4: Degradation or loss of function that is not recoverable due to damage.

The ADM2xxE family of products easily meets Classification 1 at the most stringent requirement (Level 3). In fact, field strengths up to 30 V/m showed no performance degradation, and error-free data transmission continued even during irradiation.

ADM206E/ADM207E/ADM208E/ADM211E/ADM213E

Table 10. Test Severity Levels (IEC 1000-4-3)

Level	Field Strength (V/m)
1	1
2	3
3	10

EMISSIONS/INTERFERENCE

EN 55022, CISPR 22 defines the permitted limits of radiated and conducted interference from information technology (IT) equipment. The objective of the standard is to minimize the level of emissions, both conducted and radiated.

For ease of measurement and analysis, conducted emissions are assumed to predominate below 30 MHz, and radiated emissions are assumed to predominate above 30 MHz.

CONDUCTED EMISSIONS

This is a measure of noise that is conducted onto the line power supply. Switching transients from the charge pump that are 20 V in magnitude and that contain significant energy can lead to conducted emissions. Another source of conducted emissions is the overlap in switch-on times in the charge pump voltage converter. In the voltage doubler shown in Figure 31, if S2 has not fully turned off before S4 turns on, a transient current glitch occurs between V_{CC} and GND that results in conducted emissions. Therefore, it is important that the switches in the charge pump guarantee break-before-make switching under all conditions so instantaneous short-circuit conditions do not occur.

The ADM2xxE have been designed to minimize the switching transients and ensure break-before-make switching, thereby minimizing conducted emissions. This results in emission levels well below specified limits. Other than the recommended 0.1 μF capacitor, no additional filtering/decoupling is required.

Conducted emissions are measured by monitoring the line power supply. The equipment used consists of a line impedance stabilizing network (LISN) that essentially presents a fixed impedance at RF and a spectrum analyzer. The spectrum analyzer scans for emissions up to 30 MHz. A plot for the ADM211E is shown in Figure 33.



Figure 31. Charge Pump Voltage Doubler



Figure 32. Switching Glitches



Figure 33. Conducted Emissions Plot

RADIATED EMISSIONS

Radiated emissions are measured at frequencies in excess of 30 MHz. RS-232 outputs designed for operation at high baud rates while driving cables can radiate high frequency EM energy. The previously described causes of conducted emissions can also cause radiated emissions. Fast RS-232 output transitions can radiate interference, especially when lightly loaded and driving unshielded cables. Charge pump devices are also prone to radiating noise due to the high frequency oscillator and the high voltages being switched by the charge pump. The move toward smaller capacitors in order to conserve board space has resulted in higher frequency oscillators being employed in the charge pump design, resulting in higher levels of conducted and radiated emissions.

The RS-232 outputs on the ADM2xxE products feature a controlled slew rate in order to minimize the level of radiated emissions, yet they are fast enough to support data rates of up to 230 kbps.



Figure 34. Radiated Emissions Test Setup

Figure 35 shows a plot of radiated emissions vs. frequency. The levels of emissions are well within specifications, without the need for any additional shielding or filtering components. The ADM2xxE were operated at maximum baud rates and configured like a typical RS-232 interface.

Testing for radiated emissions was carried out in a shielded anechoic chamber.



Figure 35. Radiated Emissions

ADM206E/ADM207E/ADM208E/ADM211E/ADM213E

OUTLINE DIMENSIONS



COMPLIANT TO JEDEC STANDARDS MS-001-AF
 CONTROLLING DIMENSIONS ARE IN INCHES; MILLIMETER DIMENSIONS
 (IN PARENTHESES) ARE ROUNDED-OFF INCH EQUIVALENTS FOR
 REFERENCE ONLY AND ARE NOT APPROPRIATE FOR USE IN DESIGN.
 CORNER LEADS MAY BE CONFIGURED AS WHOLE OR HALF LEADS.

Figure 36. 24-Lead Plastic Dual In-Line Package [PDIP]
 (N-24-1)
 Dimensions shown in inches and (millimeters)

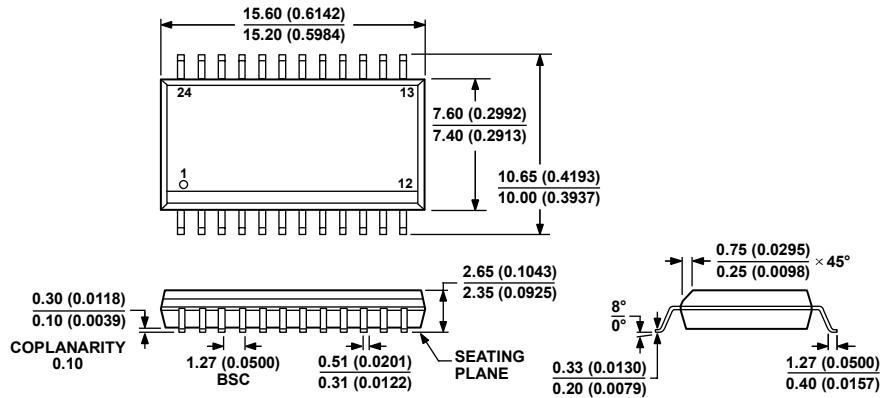

COMPLIANT TO JEDEC STANDARDS MS-013-AD
 CONTROLLING DIMENSIONS ARE IN MILLIMETERS; INCH DIMENSIONS
 (IN PARENTHESES) ARE ROUNDED-OFF MILLIMETER EQUIVALENTS FOR
 REFERENCE ONLY AND ARE NOT APPROPRIATE FOR USE IN DESIGN.

Figure 37. 24-Lead Standard Small Outline Package [SOIC_W]
 Wide Body
 (RW-24)
 Dimensions shown in millimeters and (inches)

060706-A

ADM206E/ADM207E/ADM208E/ADM211E/ADM213E

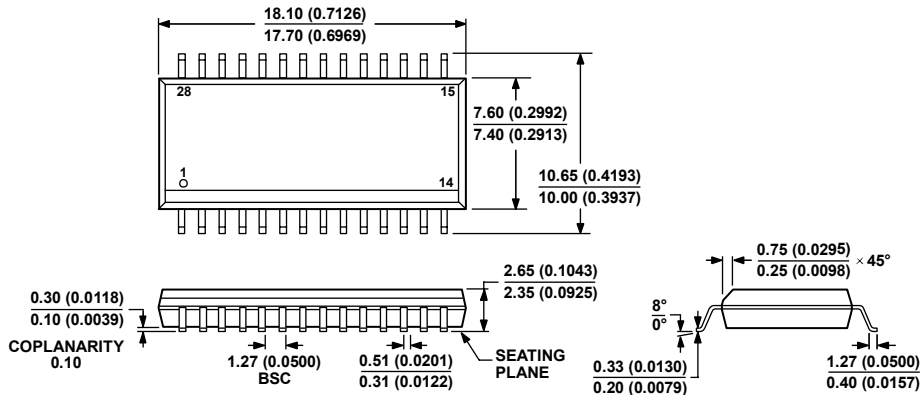

COMPLIANT TO JEDEC STANDARDS MS-013-AE
 CONTROLLING DIMENSIONS ARE IN MILLIMETERS; INCH DIMENSIONS
 (IN PARENTHESES) ARE ROUNDED-OFF MILLIMETER EQUIVALENTS FOR
 REFERENCE ONLY AND ARE NOT APPROPRIATE FOR USE IN DESIGN.

Figure 38. 28-Lead Standard Small Outline Package [SOIC_W]
 Wide Body
 (RW-28)
 Dimensions shown in millimeters and (inches)

060706-A



COMPLIANT TO JEDEC STANDARDS MO-150-AG
 Figure 39. 24-Lead Shrink Small Outline Package [SSOP]
 (RS-24)
 Dimensions shown in millimeters

060106-A

ADM206E/ADM207E/ADM208E/ADM211E/ADM213E



COMPLIANT TO JEDEC STANDARDS MO-150-AH

Figure 40. 28-Lead Shrink Small Outline Package [SSOP] (RS-28)

Dimensions shown in millimeters

06010E-A



COMPLIANT TO JEDEC STANDARDS MO-153-AD

Figure 41. 24-Lead Thin Shrink Small Outline Package [TSSOP] (RU-24)

Dimensions shown in millimeters



COMPLIANT TO JEDEC STANDARDS MO-153-AE

Figure 42. 28-Lead Thin Shrink Small Outline Package [TSSOP] (RU-28)

Dimensions shown in millimeters

ADM206E/ADM207E/ADM208E/ADM211E/ADM213E

ORDERING GUIDE

Model	Temperature Range	Package Description	Package Option
ADM206EAR	-40°C to +85°C	24-Lead SOIC_W	RW-24
ADM206EAR-REEL	-40°C to +85°C	24-Lead SOIC_W	RW-24
ADM206EARZ ¹	-40°C to +85°C	24-Lead SOIC_W	RW-24
ADM206EARZ-REEL ¹	-40°C to +85°C	24-Lead SOIC_W	RW-24
ADM207EAN	-40°C to +85°C	24-Lead PDIP	N-24-1
ADM207EANZ ¹	-40°C to +85°C	24-Lead PDIP	N-24-1
ADM207EAR	-40°C to +85°C	24-Lead SOIC_W	RW-24
ADM207EAR-REEL	-40°C to +85°C	24-Lead SOIC_W	RW-24
ADM207EARZ ¹	-40°C to +85°C	24-Lead SOIC_W	RW-24
ADM207EARZ-REEL ¹	-40°C to +85°C	24-Lead SOIC_W	RW-24
ADM207EARS	-40°C to +85°C	24-Lead SSOP	RS-24
ADM207EARS-REEL	-40°C to +85°C	24-Lead SSOP	RS-24
ADM207EARU	-40°C to +85°C	24-Lead TSSOP	RU-24
ADM207EARU-REEL	-40°C to +85°C	24-Lead TSSOP	RU-24
ADM207EARU-REEL7	-40°C to +85°C	24-Lead TSSOP	RU-24
ADM207EARUZ ¹	-40°C to +85°C	24-Lead TSSOP	RU-24
ADM207EARUZ-REEL7 ¹	-40°C to +85°C	24-Lead TSSOP	RU-24
ADM208EAN	-40°C to +85°C	24-Lead PDIP	N-24-1
ADM208EANZ ¹	-40°C to +85°C	24-Lead PDIP	N-24-1
ADM208EAR	-40°C to +85°C	24-Lead SOIC_W	RW-24
ADM208EAR-REEL	-40°C to +85°C	24-Lead SOIC_W	RW-24
ADM208EARZ ¹	-40°C to +85°C	24-Lead SOIC_W	RW-24
ADM208EARZ-REEL ¹	-40°C to +85°C	24-Lead SOIC_W	RW-24
ADM208EARS	-40°C to +85°C	24-Lead SSOP	RS-24
ADM208EARS-REEL	-40°C to +85°C	24-Lead SSOP	RS-24
ADM208EARSZ ¹	-40°C to +85°C	24-Lead SSOP	RS-24
ADM208EARSZ-REEL ¹	-40°C to +85°C	24-Lead SSOP	RS-24
ADM208EARU	-40°C to +85°C	24-Lead TSSOP	RU-24
ADM208EARU-REEL	-40°C to +85°C	24-Lead TSSOP	RU-24
ADM208EARU-REEL7	-40°C to +85°C	24-Lead TSSOP	RU-24
ADM208EARUZ ¹	-40°C to +85°C	24-Lead TSSOP	RU-24
ADM208EARUZ-REEL ¹	-40°C to +85°C	24-Lead TSSOP	RU-24
ADM211EAR	-40°C to +85°C	28-Lead SOIC_W	RW-28
ADM211EAR-REEL	-40°C to +85°C	28-Lead SOIC_W	RW-28
ADM211EARZ ¹	-40°C to +85°C	28-Lead SOIC_W	RW-28
ADM211EARZ-REEL ¹	-40°C to +85°C	28-Lead SOIC_W	RW-28
ADM211EARS	-40°C to +85°C	28-Lead SSOP	RS-28
ADM211EARS-REEL	-40°C to +85°C	28-Lead SSOP	RS-28
ADM211EARSZ ¹	-40°C to +85°C	28-Lead SSOP	RS-28
ADM211EARSZ-REEL ¹	-40°C to +85°C	28-Lead SSOP	RS-28
ADM211EARU	-40°C to +85°C	28-Lead TSSOP	RU-28
ADM211EARU-REEL	-40°C to +85°C	28-Lead TSSOP	RU-28
ADM211EARU-REEL7	-40°C to +85°C	28-Lead TSSOP	RU-28
ADM211EARUZ ¹	-40°C to +85°C	28-Lead TSSOP	RU-28
ADM211EARUZ-REEL ¹	-40°C to +85°C	28-Lead TSSOP	RU-28
ADM211EARUZ-REEL7 ¹	-40°C to +85°C	28-Lead TSSOP	RU-28

ADM206E/ADM207E/ADM208E/ADM211E/ADM213E

Model	Temperature Range	Package Description	Package Option
ADM213EAR	-40°C to +85°C	28-Lead SOIC_W	RW-28
ADM213EAR-REEL	-40°C to +85°C	28-Lead SOIC_W	RW-28
ADM213EARZ ¹	-40°C to +85°C	28-Lead SOIC_W	RW-28
ADM213EARZ-REEL ¹	-40°C to +85°C	28-Lead SOIC_W	RW-28
ADM213EARS	-40°C to +85°C	28-Lead SSOP	RS-28
ADM213EARS-REEL	-40°C to +85°C	28-Lead SSOP	RS-28
ADM213EARSZ ¹	-40°C to +85°C	28-Lead SSOP	RS-28
ADM213EARSZ-REEL ¹	-40°C to +85°C	28-Lead SSOP	RS-28
ADM213EARU	-40°C to +85°C	28-Lead TSSOP	RU-28
ADM213EARU-REEL	-40°C to +85°C	28-Lead TSSOP	RU-28
ADM213EARU-REEL7	-40°C to +85°C	28-Lead TSSOP	RU-28
ADM213EARUZ ¹	-40°C to +85°C	28-Lead TSSOP	RU-28
ADM213EARUZ-REEL ¹	-40°C to +85°C	28-Lead TSSOP	RU-28
ADM213EARUZ-REEL7 ¹	-40°C to +85°C	28-Lead TSSOP	RU-28

¹ Z = Pb-free part.

Looking for pricing, stock, or lifecycle information?

Click below to explore more details on WIN SOURCE:

- ⊖ [View ADM208EARZ-REEL on WIN SOURCE](#)
- ⊖ [Analog Devices Inc. Information](#)

Optimize Your Supply Chain with WIN SOURCE Solutions

- ✓ Global Sourcing Solution
- ✓ Obsolete Management
- ✓ Cost Control Management
- ✓ Shortage Management
- ✓ Alternative Solution
- ✓ Excess Inventory Management