



**THE DATASHEET OF  
ADM1486ARZ-REEL7**



### FEATURES

- Meets and exceeds EIA RS-485 and EIA RS-422 standards
- 30 Mbps data rate
- Recommended for PROFIBUS applications
- 2.1 V minimum differential output with 54 Ω termination
- Low power 0.8 mA I<sub>CC</sub>
- Thermal shutdown and short-circuit protection
- 0.5 ns skew driver and receiver
- Driver propagation delay: 11 ns
- Receiver propagation delay: 12 ns
- High impedance outputs with drivers disabled or power off
- Superior upgrade for SN65ALS1176
- Available in standard 8-lead SOIC package

### APPLICATIONS

Industrial field equipment

### GENERAL DESCRIPTION

The ADM1486 is a differential line transceiver suitable for high speed bidirectional data communication on multipoint bus transmission lines. It is designed for balanced data transmission, complies with EIA Standards RS-485 and RS-422, and is recommended for PROFIBUS applications. The part contains a differential line driver and a differential line receiver. Both the driver and the receiver may be enabled independently. When disabled or powered down, the driver outputs are high impedance.

The ADM1486 operates from a single 5 V power supply. Excessive power dissipation caused by bus contention or output shorting is prevented by short-circuit protection and thermal circuitry. Short-circuit protection circuits limit the maximum output current to ±200 mA during fault conditions. A thermal shutdown circuit senses if the die temperature rises above 150°C and forces the driver outputs into a high impedance state under this condition.

Up to 50 transceivers may be connected simultaneously on a bus, but only one driver should be enabled at a time. Therefore, it is important that the remaining disabled drivers do not load the bus.



### Rev. A

Information furnished by Analog Devices is believed to be accurate and reliable. However, no responsibility is assumed by Analog Devices for its use, nor for any infringements of patents or other rights of third parties that may result from its use. Specifications subject to change without notice. No license is granted by implication or otherwise under any patent or patent rights of Analog Devices. Trademarks and registered trademarks are the property of their respective owners.

### FUNCTIONAL BLOCK DIAGRAM

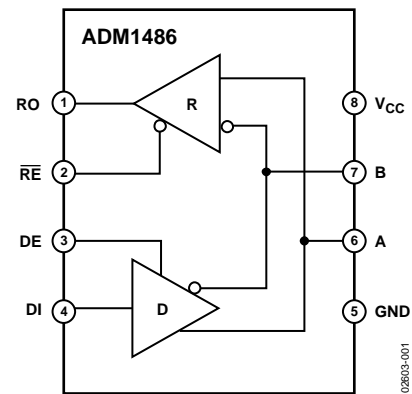

Figure 1.

To ensure this, the ADM1486 driver features high output impedance when disabled and when powered down. This minimizes the loading effect when the transceiver is not being used. The high impedance driver output is maintained over the entire common-mode voltage range from -7 V to +12 V.

The receiver contains a fail-safe feature that results in a logic high output state if the inputs are unconnected (floating).

The ADM1486 is fabricated on BiCMOS, an advanced mixed technology process combining low power CMOS with fast switching bipolar technology. All inputs and outputs contain protection against ESD; all driver outputs feature high source and sink current capability. An epitaxial layer is used to guard against latch-up.

The ADM1486 features extremely fast and closely matched switching, enable, and disable times. Minimal driver propagation delays permit transmission at data rates up to 30 Mbps while low skew minimizes EMI interference.

The part is fully specified over the commercial and industrial temperature range and is available in an 8-lead SOIC package.

## TABLE OF CONTENTS

Specifications.....	3	Applications Information .....	13
Timing Specifications.....	4	Differential Data Transmission .....	13
Absolute Maximum Ratings.....	5	Cable and Data Rate.....	13
ESD Caution.....	5	Thermal Shutdown .....	13
Pin Configuration and Function Descriptions.....	6	Propagation Delay .....	13
Test Circuits.....	7	Receiver Open-Circuit Fail-Safe.....	13
Switching Characteristics .....	8	Outline Dimensions .....	15
Typical Performance Characteristics .....	9	Ordering Guide .....	15

## REVISION HISTORY

### 3/05—Rev. 0 to Rev. A

Updated Format.....	Universal
Added PROFIBUS Logo .....	1
Updated Outline Dimensions .....	15
Changes to Ordering Guide .....	15

### 11/02—Revision 0: Initial Version

## SPECIFICATIONS

$V_{CC} = 5\text{ V} \pm 5\%$ . All specifications  $T_{MIN}$  to  $T_{MAX}$ , unless otherwise noted.

Table 1.

Parameter	Min	Typ	Max	Unit	Test Conditions/Comments
<b>DRIVER</b>					
Differential Output Voltage, $V_{OD}$			5.0	V	R = Infinity, see Figure 3
	2.1		5.0	V	$V_{CC} = 5\text{ V}$ , R = 50 $\Omega$ (RS-422), see Figure 3
	2.1		5.0	V	R = 27 $\Omega$ (RS-485), see Figure 3
$V_{OD3}$	2.1		5.0	V	$V_{TST} = -7\text{ V}$ to $+12\text{ V}$ , see Figure 4
$\Delta V_{OD} $ for Complementary Output States			0.2	V	R = 27 $\Omega$ or 50 $\Omega$ , see Figure 3
Common-Mode Output Voltage $V_{OC}$			3.0	V	R = 27 $\Omega$ or 50 $\Omega$ , see Figure 3
$\Delta V_{OC} $ for Complementary Output States			0.2	V	R = 27 $\Omega$ or 50 $\Omega$
Output Short-Circuit Current ( $V_{OUT} = \text{High}$ )	60		200	mA	$-7\text{ V} \leq V_O \leq +12\text{ V}$
Output Short-Circuit Current ( $V_{OUT} = \text{Low}$ )	60		200	mA	$-7\text{ V} \leq V_O \leq +12\text{ V}$
CMOS Input Logic Threshold Low, $V_{INL}$			0.8	V	
CMOS Input Logic Threshold High, $V_{INH}$	2.0			V	
Logic Input Current (DE, DI)			$\pm 1.0$	$\mu\text{A}$	
<b>RECEIVER</b>					
Differential Input Threshold Voltage, $V_{TH}$	-0.2		+0.2	V	$-7\text{ V} \leq V_{CM} \leq +12\text{ V}$
Input Voltage Hysteresis, $\Delta V_{TH}$		70		mV	$V_{CM} = 0\text{ V}$
Input Resistance	20	30		k $\Omega$	$-7\text{ V} \leq V_{CM} \leq +12\text{ V}$
Input Current (A, B)			0.6	mA	$V_{IN} = +12\text{ V}$
			-0.35	mA	$V_{IN} = -7\text{ V}$
Logic Enable Input Current ( $\overline{RE}$ )			$\pm 1.0$	$\mu\text{A}$	
CMOS Output Voltage Low, $V_{OL}$			0.4	V	$I_{OUT} = +4.0\text{ mA}$
CMOS Output Voltage High, $V_{OH}$	4.0			V	$I_{OUT} = -4.0\text{ mA}$
Short-Circuit Output Current	7		85	mA	$V_{OUT} = \text{GND}$ or $V_{CC}$
Three-State Output Leakage Current			$\pm 1.0$	$\mu\text{A}$	$0.4\text{ V} \leq V_{OUT} \leq 2.4\text{ V}$
<b>POWER SUPPLY CURRENT</b>					
$I_{CC}$ (Outputs Enabled)		1.2	2.0	mA	Outputs unloaded, digital inputs = GND or $V_{CC}$
$I_{CC}$ (Outputs Disabled)		0.8	1.5	mA	Outputs unloaded, digital inputs = GND or $V_{CC}$

## TIMING SPECIFICATIONS

$V_{CC} = 5\text{ V} \pm 5\%$ . All specifications  $T_{MIN}$  to  $T_{MAX}$ , unless otherwise noted.

**Table 2.**

Parameter	Min	Typ	Max	Unit	Test Conditions/Comments
<b>DRIVER</b>					
Propagation Delay Input to Output $t_{PLH}$ , $t_{PHL}$	4	11	17	ns	$R_{L,DIFF} = 54\ \Omega$ , $C_{L1} = C_{L2} = 100\text{ pF}$ , see Figure 5
		11	13	ns	$R_{L,DIFF} = 54\ \Omega$ , $C_{L1} = C_{L2} = 100\text{ pF}$ @ $T_A = 25^\circ\text{C}$
Driver O/P to $\overline{O/P}$ $t_{SKEW}$		0.5	2	ns	$R_{L,DIFF} = 54\ \Omega$ , $C_{L1} = C_{L2} = 100\text{ pF}$ , see Figure 5 <sup>1</sup>
Driver Rise/Fall Time $t_R$ , $t_F$		8	15	ns	$R_{L,DIFF} = 54\ \Omega$ , $C_{L1} = C_{L2} = 100\text{ pF}$ , see Figure 5
Driver Enable to Output Valid $t_{ZH}$ , $t_{ZL}$		9	15	ns	$R_L = 110\ \Omega$ , $C_L = 50\text{ pF}$ , see Figure 6
Driver Disable Timing $t_{HZ}$ , $t_{LZ}$		9	15	ns	$R_L = 110\ \Omega$ , $C_L = 50\text{ pF}$ , see Figure 6
Matched Enable Switching $ t_{AZH} - t_{BZL} $ , $ t_{BZH} - t_{AZL} $		1	3	ns	$R_L = 110\ \Omega$ , $C_L = 50\text{ pF}$ , see Figure 6
Matched Disable Switching $ t_{AHZ} - t_{BLZ} $ , $ t_{BHZ} - t_{ALZ} $		2	5	ns	$R_L = 110\ \Omega$ , $C_L = 50\text{ pF}$ , see Figure 6
<b>RECEIVER</b>					
Propagation Delay Input to Output $t_{PLH}$ , $t_{PHL}$	6	12	20	ns	$C_L = 15\text{ pF}$ , see Figure 7
Skew $ t_{PLH} - t_{PHL} $		0.4	2	ns	$C_L = 15\text{ pF}$ <sup>1</sup> , see Figure 7
Receiver Enable $t_{ZH}$ , $t_{ZL}$		7	13	ns	$C_L = 15\text{ pF}$ , $R_L = 1\text{ k}\Omega$ , see Figure 8
Receiver Disable $t_{HZ}$ , $t_{LZ}$		7	13	ns	$C_L = 15\text{ pF}$ , $R_L = 1\text{ k}\Omega$ , see Figure 8

<sup>1</sup> Guaranteed by characterization.

## ABSOLUTE MAXIMUM RATINGS

$T_A = 25^\circ\text{C}$ , unless otherwise noted.

**Table 3.**

Parameter	Rating
$V_{CC}$	7 V
Inputs	
Driver Input (DI)	$-0.3\text{ V to }V_{CC} + 0.3\text{ V}$
Control Inputs (DE, $\overline{RE}$ )	$-0.3\text{ V to }V_{CC} + 0.3\text{ V}$
Receiver Inputs (A, B)	$-9\text{ V to }+14\text{ V}$
Outputs	
Driver Outputs	$-9\text{ V to }+14\text{ V}$
Receiver Outputs	$-0.5\text{ V to }V_{CC} + 0.5\text{ V}$
Power Dissipation 8-Lead SOIC	450 mW
$\theta_{JA}$ , Thermal Impedance	$170^\circ\text{C/W}$
Operating Temperature Range	
Industrial (A Version)	$-40^\circ\text{C to }+85^\circ\text{C}$
Storage Temperature Range	$-65^\circ\text{C to }+150^\circ\text{C}$
Lead Temperature (Soldering, 10 sec)	$300^\circ\text{C}$
Vapor Phase (60 sec)	$215^\circ\text{C}$
Infrared (15 sec)	$220^\circ\text{C}$

Stresses above those listed under Absolute Maximum Ratings may cause permanent damage to the device. This is a stress rating only; functional operation of the device at these or any other conditions above those indicated in the in the operational section of this specification is not implied. Exposure to absolute maximum rating conditions for extended periods of time may affect device reliability.

### ESD CAUTION

ESD (electrostatic discharge) sensitive device. Electrostatic charges as high as 4000 V readily accumulate on the human body and test equipment and can discharge without detection. Although this product features proprietary ESD protection circuitry, permanent damage may occur on devices subjected to high energy electrostatic discharges. Therefore, proper ESD precautions are recommended to avoid performance degradation or loss of functionality.



# ADM1486

## PIN CONFIGURATION AND FUNCTION DESCRIPTIONS

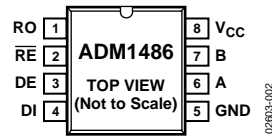

Figure 2. Pin Configuration

Table 4. Pin Function Descriptions

Pin No.	Mnemonic	Description
1	RO	Receiver Output. When enabled, if $A > B$ by 200 mV, RO = high. If $A < B$ by 200 mV, RO = low.
2	$\overline{RE}$	Receiver Output Enable. A low level enables the receiver output, RO. A high level places it in a high impedance state.
3	DE	Driver Output Enable. A high level enables the driver differential outputs, A and B. A low level places it in a high impedance state.
4	DI	Driver Input. When the driver is enabled, a logic low on DI forces A low and B high, while a logic high on DI forces A high and B low.
5	GND	Ground Connection, 0 V.
6	A	Noninverting Receiver Input A/Driver Output A.
7	B	Inverting Receiver Input B/Driver Output B.
8	V <sub>CC</sub>	Power Supply, 5 V $\pm$ 5%.

Table 5. Transmitting

DE Input	DI Input	B Output	A Output
1	1	0	1
1	0	1	0
0	X	Z	Z

Table 6. Receiving

$\overline{RE}$	A-B Input	RO Output
0	$\geq +0.2$ V	1
0	$\leq -0.2$ V	0
0	Inputs open	1
1	X	Z

# TEST CIRCUITS

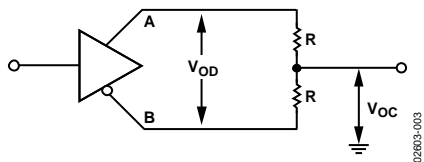

Figure 3. Driver Voltage Measurement

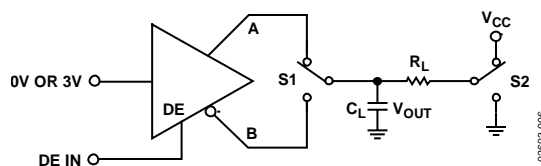

Figure 6. Driver Enable/Disable

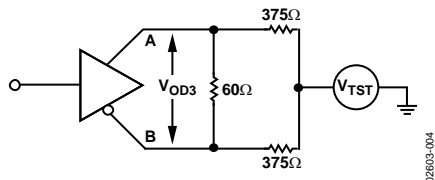

Figure 4. Driver Voltage Measurement

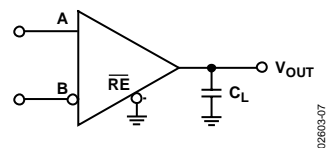

Figure 7. Receiver Propagation Delay

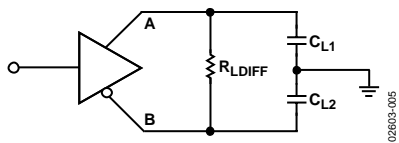

Figure 5. Driver Propagation Delay

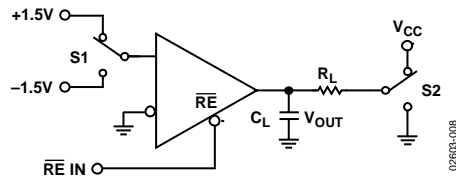

Figure 8. Receiver Enable/Disable

# SWITCHING CHARACTERISTICS

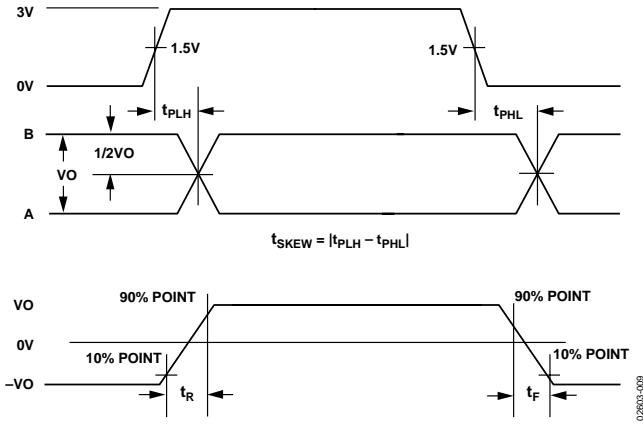

Figure 9. Driver Propagation Delay, Rise/Fall Timing

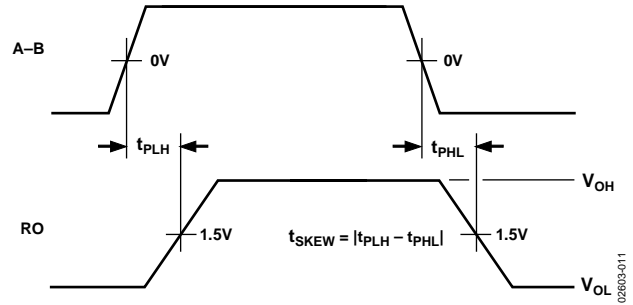

Figure 11. Receiver Propagation Delay

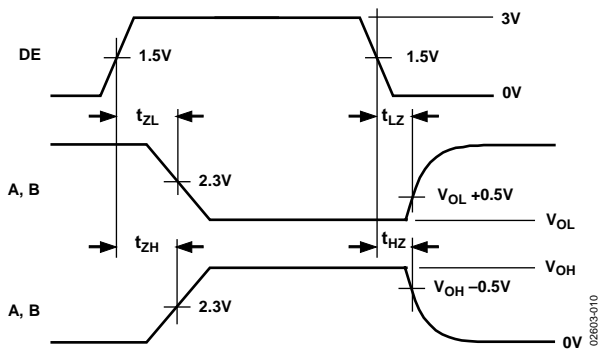

Figure 10. Driver Enable/Disable Timing

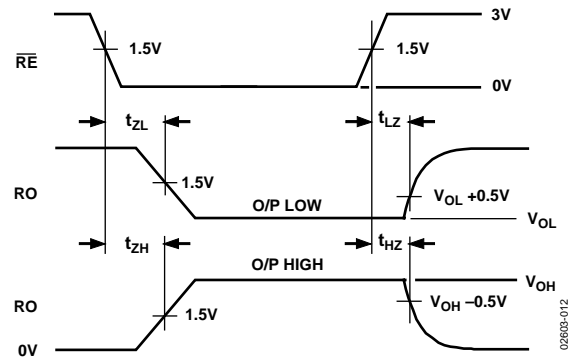

Figure 12. Receiver Enable/Disable Timing

## TYPICAL PERFORMANCE CHARACTERISTICS

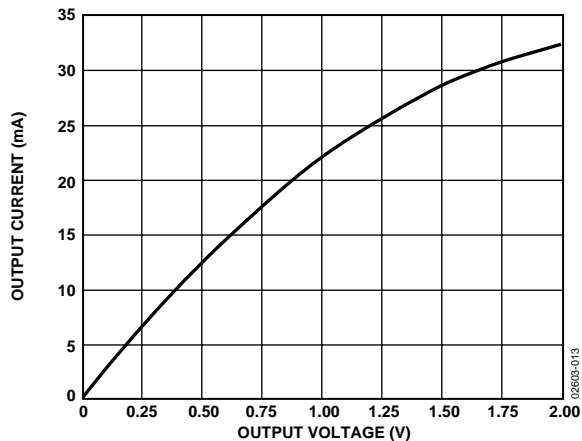

Figure 13. Output Current vs. Receiver Output Low Voltage

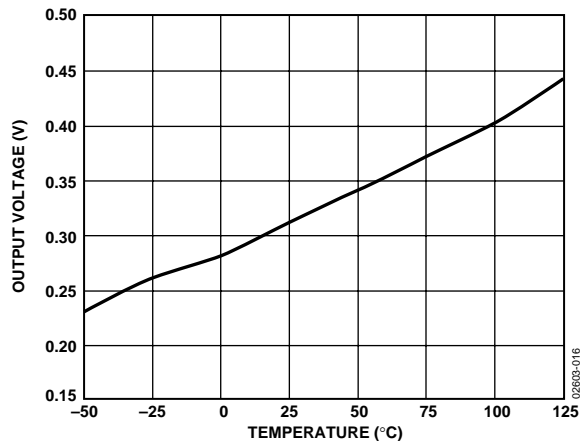

Figure 16. Receiver Output Low Voltage vs. Temperature ( $I = 8 \text{ mA}$ )

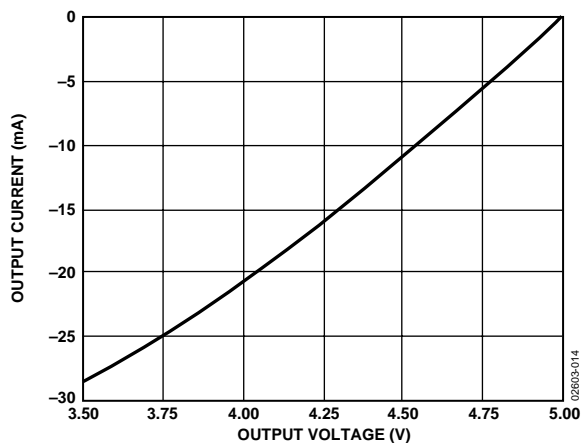

Figure 14. Output Current vs. Receiver Output High Voltage

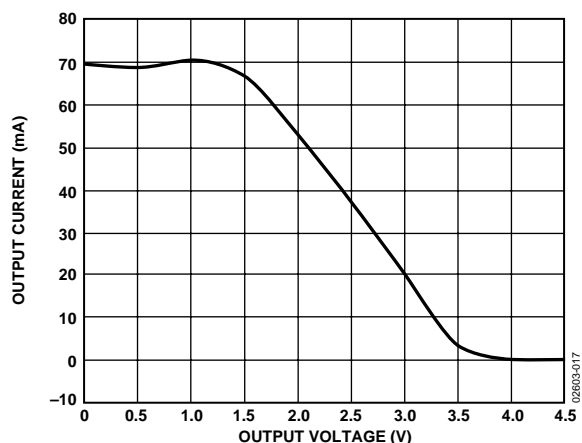

Figure 17. Output Current vs. Driver Differential Output Voltage

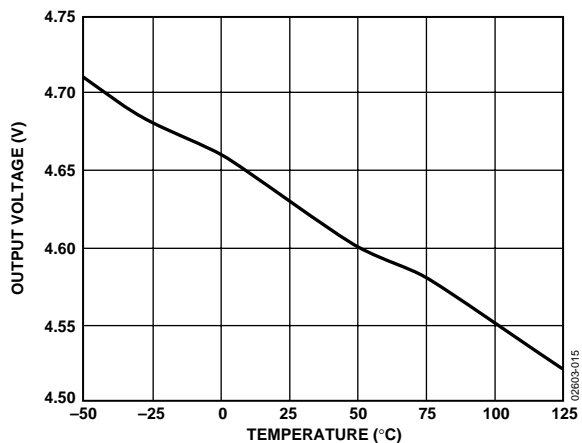

Figure 15. Receiver Output High Voltage vs. Temperature ( $I = 8 \text{ mA}$ )

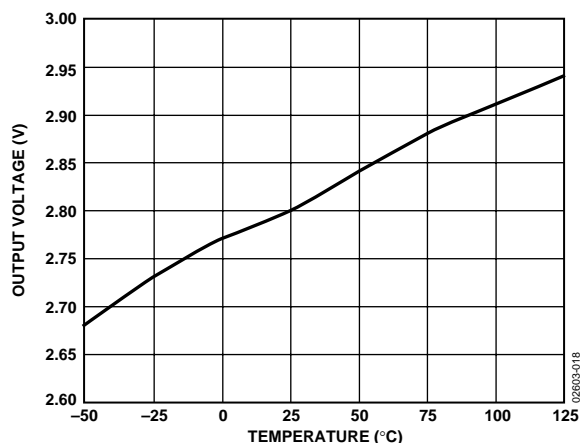

Figure 18. Driver Differential Output Voltage vs. Temperature ( $R_{L\text{DIFF}} = 53.6 \Omega$ )

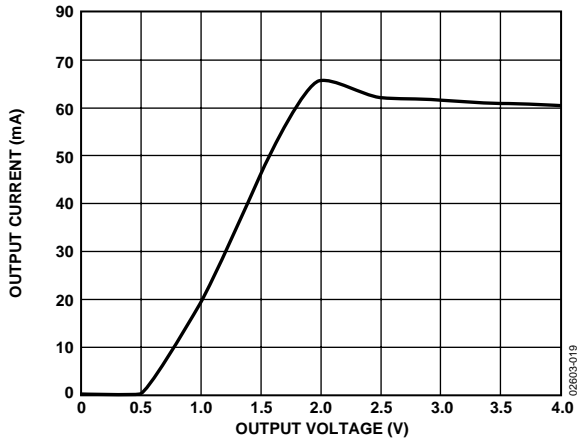

Figure 19. Output Current vs. Driver Output Low Voltage

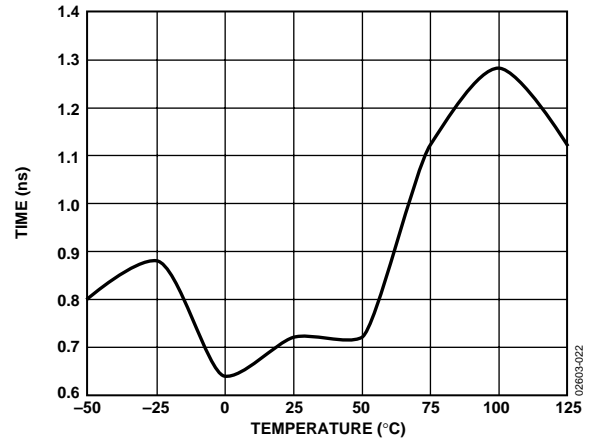

Figure 22. Receiver Skew vs. Temperature

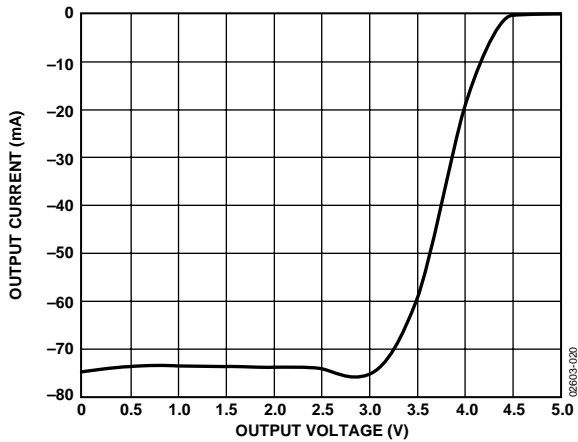

Figure 20. Output Current vs. Driver Output High Voltage

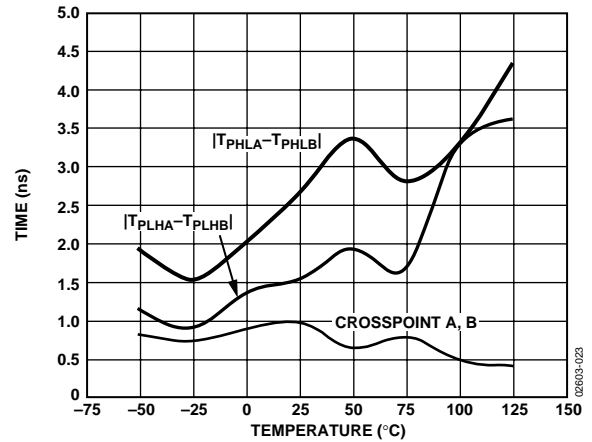

Figure 23. Driver Skew vs. Temperature

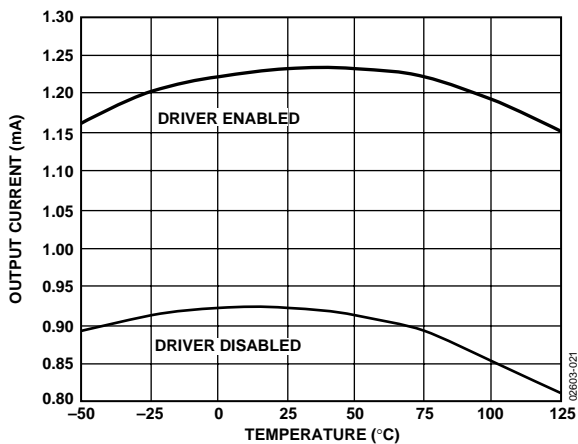

Figure 21. Supply Current vs. Temperature

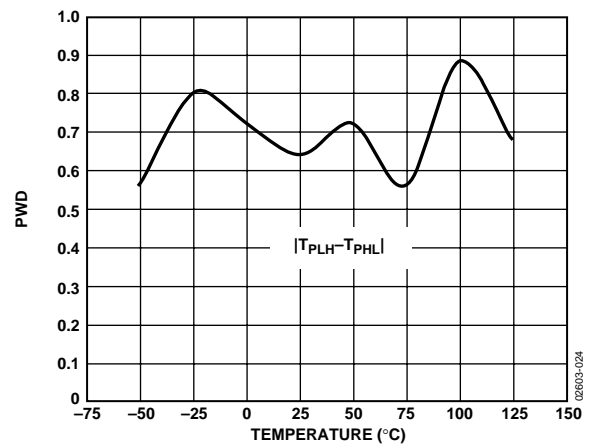

Figure 24. Tx Pulse Width Distortion

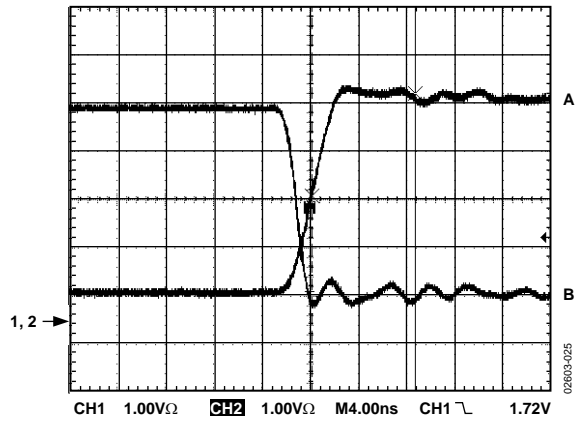

Figure 25. Unloaded Driver Differential Outputs

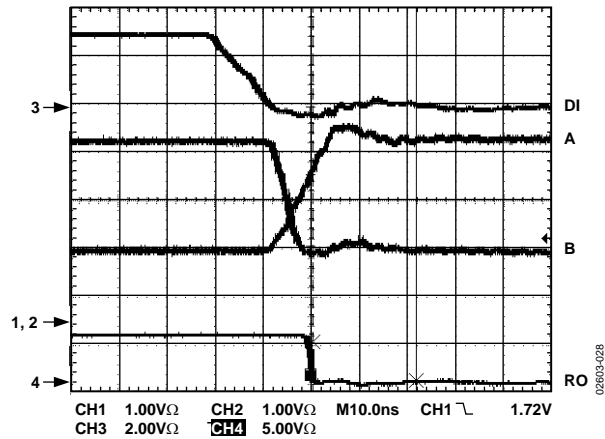

Figure 28. Driver/Receiver Propagation Delays High to Low ( $R_{LDiff} = 54 \Omega$ ,  $C_{L1} = C_{L2} = 100 \text{ pF}$ )

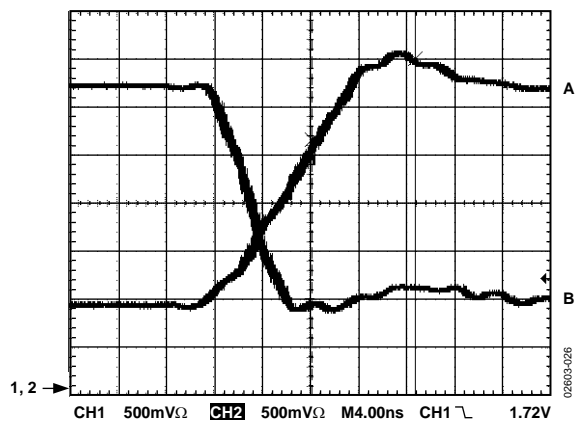

Figure 26. Loaded Driver Differential Output ( $R_{LDiff} = 54 \Omega$ ,  $C_{L1} = C_{L2} = 100 \text{ pF}$ )

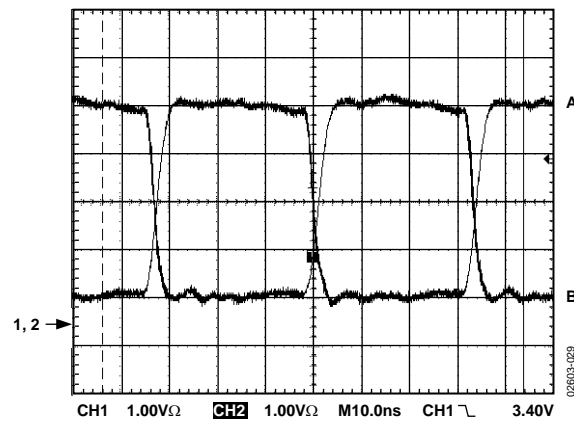

Figure 29. Unloaded Driver Outputs at 15 Mbps

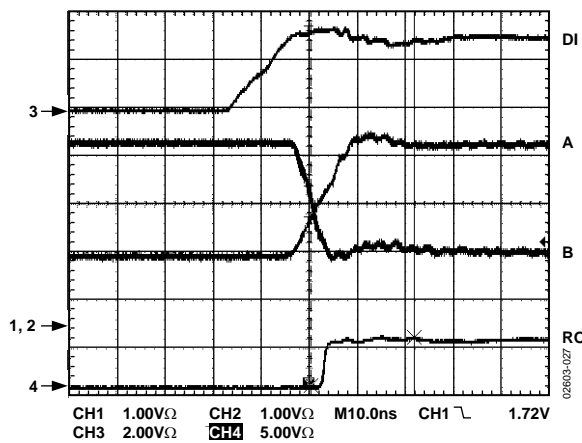

Figure 27. Driver/Receiver Propagation Delays Low to High ( $R_{LDiff} = 54 \Omega$ ,  $C_{L1} = C_{L2} = 100 \text{ pF}$ )

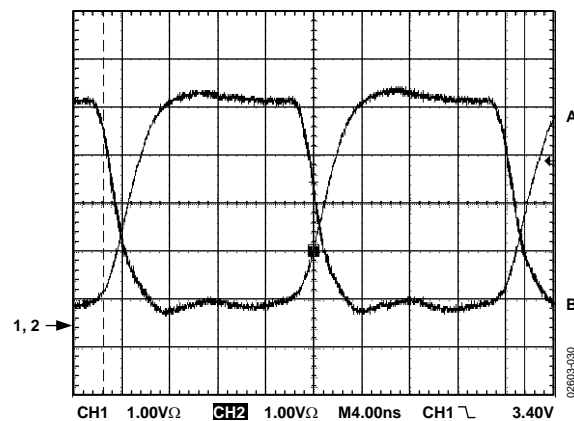

Figure 30. Unloaded Driver Outputs at 30 Mbps

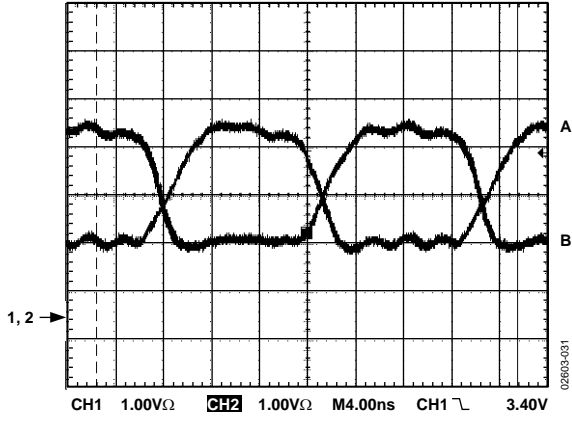

Figure 31. Loaded Driver Outputs at 15 Mbps  
( $R_{LDIFF} = 54 \Omega$ ,  $C_{L1} = C_{L2} = 100 \text{ pF}$ )

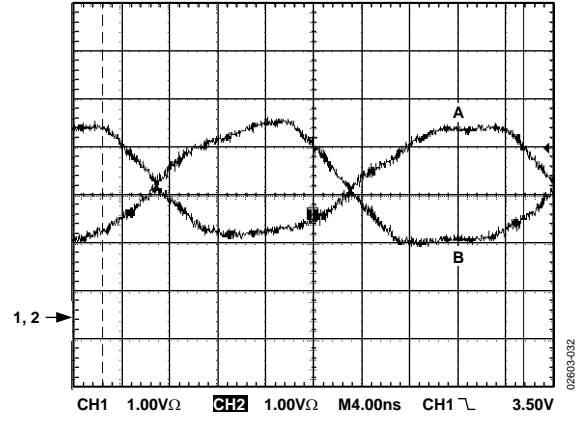

Figure 32. Loaded Driver Outputs at 30 Mbps  
( $R_{LDIFF} = 54 \Omega$ ,  $C_{L1} = C_{L2} = 100 \text{ pF}$ )

## APPLICATIONS INFORMATION

### DIFFERENTIAL DATA TRANSMISSION

Differential data transmission is used to reliably transmit data at high rates over long distances and through noisy environments. Differential transmission nullifies the effects of ground shifts and noise signals that appear as common-mode voltages on the line. There are two main standards approved by the Electronics Industries Association (EIA) that specify the electrical characteristics of transceivers used in differential data transmission.

The RS-422 standard specifies data rates up to 10 MBaud and line lengths up to 4,000 feet. A single driver can drive a transmission line with up to 10 receivers.

In order to address true multipoint communications, the RS-485 standard was defined. This standard meets or exceeds all of the requirements of RS-422, and it allows up to 32 drivers and 32 receivers to connect to a single bus. An extended common-mode range of  $-7\text{ V}$  to  $+12\text{ V}$  is defined. The most significant difference between the RS-422 and the RS-485 is that the drivers with RS-485 can be disabled, allowing more than one driver to be connected to a single line; in fact, 32 drivers can be connected to a single line. Only one driver should be enabled at a time, but the RS-485 standard contains additional specifications to guarantee device safety in the event of line contention.

### CABLE AND DATA RATE

Twisted pair is the transmission line of choice for RS-485 communications. Twisted pair cable tends to cancel common-mode noise and causes cancellation of the magnetic fields generated by the current flowing through each wire, thereby reducing the effective inductance of the pair.

The ADM1486 is designed for bidirectional data communications on multipoint transmission lines. A typical application showing a multipoint transmission network is shown in Figure 33.

An RS-485 transmission line can have as many as 32 transceivers on the bus. Only one driver can transmit at a time, but multiple receivers may be enabled simultaneously.

As with any transmission line, it is important to minimize reflections. This can be achieved by terminating the extreme ends of the line using resistors equal to the characteristic impedance of the line. Stub lengths of the main line should also be kept as short as possible. A properly terminated transmission line appears purely resistive to the driver.

### THERMAL SHUTDOWN

The ADM1486 contains thermal shutdown circuitry that protects the part from excessive power dissipation during fault conditions. Shorting the driver outputs to a low impedance source can result in high driver currents. Thermal sensing circuitry detects the increase in die temperature and disables the driver outputs. Thermal sensing circuitry is designed to disable the driver outputs when a die temperature reaches  $150^{\circ}\text{C}$ . As the device cools, the drivers are re-enabled at  $140^{\circ}\text{C}$ .

### PROPAGATION DELAY

The ADM1486 features very low propagation delay, ensuring maximum baud rate operation. The well-balanced driver ensures distortion-free transmission.

Another important specification is a measure of the skew between the complementary outputs. Excessive skew impairs the noise immunity of the system and increases the amount of electromagnetic interference (EMI).

### RECEIVER OPEN-CIRCUIT FAIL-SAFE

The receiver input includes a fail-safe feature that guarantees a logic high on the receiver when the inputs are open circuit or floating.

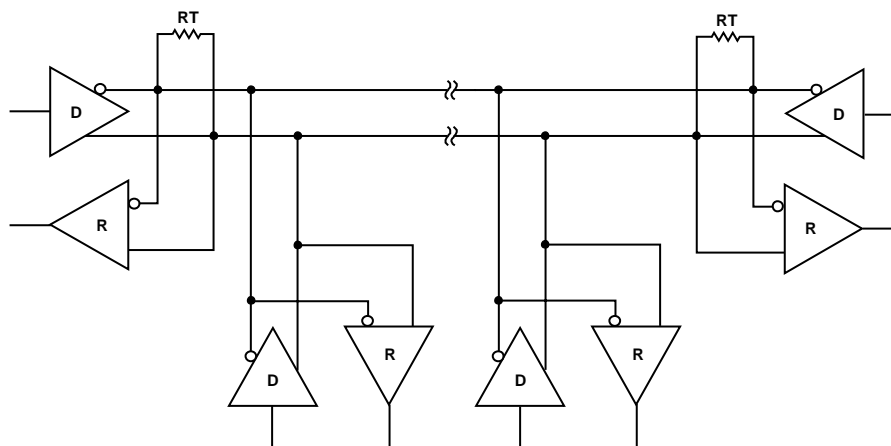

Figure 33. Typical RS-485 Network

# ADM1486

**Table 7. Comparison of RS-422, RS-485, and PROFIBUS Interface Standards**

<b>Specification</b>	<b>RS-422</b>	<b>RS-485</b>	<b>PROFIBUS</b>
Transmission Type	Differential	Differential	Differential
Maximum Cable Length	4,000 ft.	4,000 ft.	
Minimum Driver Output Voltage	$\pm 2$ V	$\pm 1.5$ V	$\pm 2.1$ V
Driver Load Impedance	100 $\Omega$	54 $\Omega$	54 $\Omega$
Receiver Input Resistance	4 k $\Omega$ min	12 k $\Omega$ min	20 k $\Omega$ min
Receiver Input Sensitivity	$\pm 200$ mV	$\pm 200$ mV	$\pm 200$ mV
Receiver Input Voltage Range	-7 V to +7 V	-7 V to +12 V	-7 V to +12 V
No. of Drivers/Receivers per Line	1/10	32/32	50/50

# OUTLINE DIMENSIONS

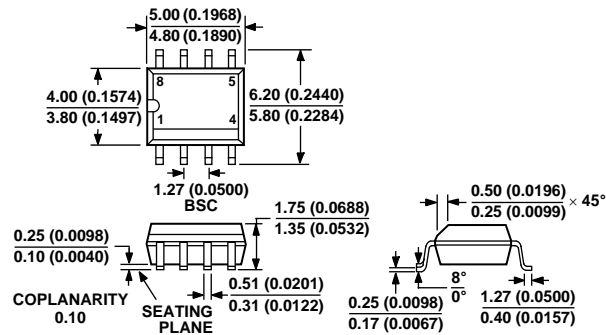

COMPLIANT TO JEDEC STANDARDS MS-012AA  
 CONTROLLING DIMENSIONS ARE IN MILLIMETERS; INCH DIMENSIONS  
 (IN PARENTHESES) ARE ROUNDED-OFF MILLIMETER EQUIVALENTS FOR  
 REFERENCE ONLY AND ARE NOT APPROPRIATE FOR USE IN DESIGN

Figure 34. 8-Lead Standard Small Outline Package [SOIC]  
 Narrow Body  
 (R-8)

Dimensions shown in millimeters and (inches)

## ORDERING GUIDE

Model	Temperature Range	Package Description	Package Option
ADM1486AR	-40°C to +85°C	8-Lead Narrow Body (SOIC)	R-8
ADM1486AR-REEL	-40°C to +85°C	8-Lead Narrow Body (SOIC)	R-8
ADM1486AR-REEL7	-40°C to +85°C	8-Lead Narrow Body (SOIC)	R-8
ADM1486ARZ <sup>1</sup>	-40°C to +85°C	8-Lead Narrow Body (SOIC)	R-8
ADM1486ARZ-REEL <sup>1</sup>	-40°C to +85°C	8-Lead Narrow Body (SOIC)	R-8
ADM1486ARZ-REEL7 <sup>1</sup>	-40°C to +85°C	8-Lead Narrow Body (SOIC)	R-8

<sup>1</sup> Z = Pb-free part.

**ADM1486**

## **NOTES**

## Looking for pricing, stock, or lifecycle information?

Click below to explore more details on WIN SOURCE:

- ⊖ [View ADM1486ARZ-REEL7 on WIN SOURCE](#)
- ⊖ [Analog Devices Inc. Information](#)

## Optimize Your Supply Chain with WIN SOURCE Solutions

- ✓ Global Sourcing Solution
- ✓ Obsolete Management
- ✓ Cost Control Management
- ✓ Shortage Management
- ✓ Alternative Solution
- ✓ Excess Inventory Management