

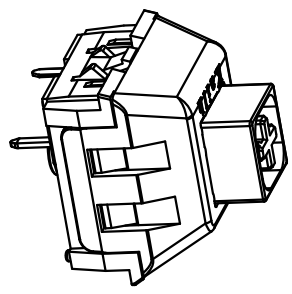

THE DATASHEET OF
5150

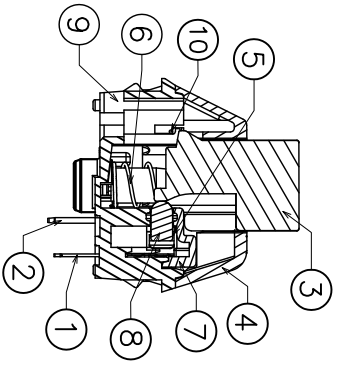

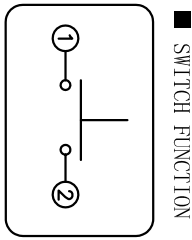
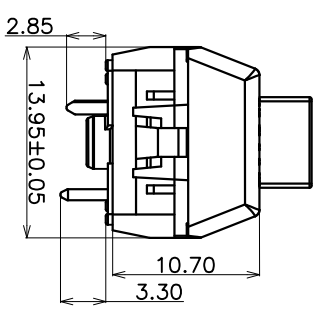
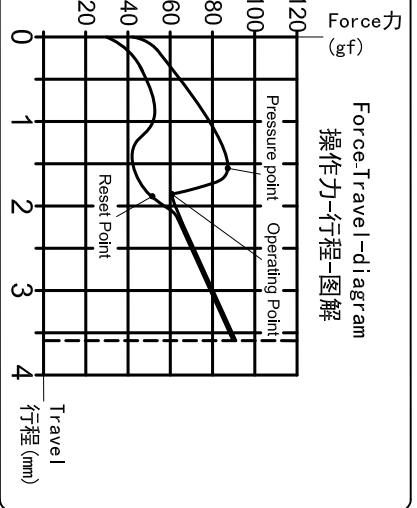

Specification :

- 1. Rating: 12 VAC/DC max. 2 VDC min. 10mA AC/DC max. 10μA DC min.
- 2. Contact Resistance: 200mΩ Max
- 3. Insulation Resistance: 100MΩ Min. (DC100V)
- 4. Withstand Voltage: AC100V(50-60Hz) for 1 minute
- 5. Tactile Force: 95±15gf
- 6. Operation Force: 60±15gf
- 7. Return Force ≥15gf
- 8. Conduction travel: 1.80±0.3mm
- 9. Total travel: 3.60±0.3mm
- 10. Operating Life: 80,000,000 Cycles(min).
- 11. Degree of protection: IP56(excluding the terminals)

<Feel is allowed to have difference before and after life test>

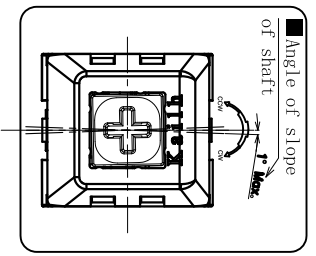
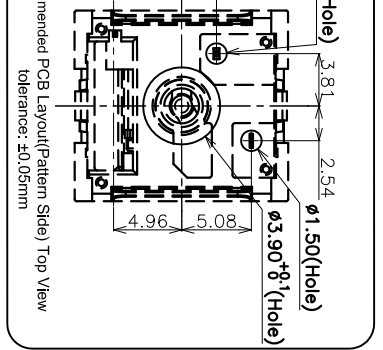

⑩	Torsional Spring	1	Stainless Steel	Nature		
⑨	Base	1	PA66	White		
⑧	Slider	1	POM	Green		
⑦	Protecting cover	1	PA66	Nature		
⑥	Spring	1	Stainless Steel	Nature		
⑤	Contact	2	Composite gold			
④	Cover	1	PC	Nature		
③	Keystroke	1	POM	Dark Blue		
②	Static Plate	1	Brass	Plating NI		
①	Movable Plate	1	Copper Alloy	Nature		
ITEM	PART NAME	TER.NO.	QTY.	MATERIAL	FINISHING	REMARK

32±0.02 CHANGED TO 1.30±0.02		L.Zhang			
NEW	L.Zhang				
DESCRIPTION.	CHANGE.	CHECK.	APPRO.		
APPROVALS		DATE	DONGGUAN CITY KAHUA ELECTRONICS CO.,LTD		
DRAWN	L.Zhang	2018.03.17	Kaifu		
CHECKED			TITLE:	Keystroke Switch (Dark blue shaft)	
APPROVALS			PART NO.	CPG1511P01S09-1	
TOLERANCES ARE		ANGLE	UNIT:	SCALE:	PROJ.
30±L	±0.30		mm	1:1	Prod.
10<L≤30	±0.20				1 OF 1
5<L≤10	±0.15	±2°	DRAWING NO.		SHEET
L≤5	±0.10				



凱華電子
KAIHUA EEELETRONICS

Document Number:

KH-PS1803-33

产品规格书

Product Specification

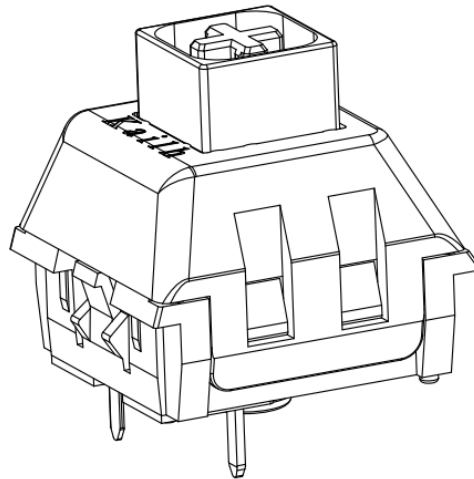

Dark Blue shaft (1# cover)
深蓝轴(1#盖子)

P/N: CPG1511F01S09-1			Title : PG1511F Keyboard Switch		
Rev.	ECN	Release and Revision Description:	Prepared By /Date:	Checked By/Date:	Approved By/Date:
A	— —	New releasing 初版发行	张林/2018.03.17	易平/2018.03.17	王锋/2018.03.17
B	— —	修改导芯十字芯尺寸	张林/2018.08.01	易平/2018.08.01	王锋/2018.08.01



P/N: CPG1511F01S09-1	DOC. No.: KH-PS1803-33	Rev.: B	Page: 2/11
--------------------------------	----------------------------------	-------------------	----------------------

Content

目录

1. Scope/范围:	3
2. Product Application/产品应用:	3
3. Technology Parameters/技术参数	3
4. Ratings/额定性能要求	3
5. Profile Dimensions /外形尺寸	3
6. Electrical Performance/电气性能	4
7. Mechanical Performance/机械性能	5-6
8. Environmental Performance/环境性能	7-8
9. Recommended PCB Layout/推荐的 PCB 安装焊盘规格	9
10. Loading Parameter Specification/荷重参数规格	10
11. Packaging/包装	10-11
12. Precaution/注意事项	11



P/N: CPG1511F01S09-1	DOC. No.: KH-PS1803-33	Rev.: B	Page: 3/11
--------------------------------	----------------------------------	-------------------	----------------------

1. Scope/范围:

This Product Specification covers the requirement of Mechanical Keyboard switch on product performance, test methods and quality assurance provisions.
本规格书内容涵盖机械键盘开关产品的要求，包括性能指标、测试方法及质量保证方面等。

2. Product Application/产品应用:

Mainly applied on computer keyboards, cash registers, industrial equipment and Man-Machine interface.
主要适用于电脑键盘，收银机、工业设备和人机界面。

3. Technology Parameters/技术参数

Ambient Humidity 工作湿度: 45~85% R.H.;

Operating Temperature Range 使用温度范围: -10℃~+70℃;

Storage Temperature Range 保存温度范围: -20℃~+70℃;

Suggested storage period 贮存期限: about 6 months 最多 6 个月

Require the tin part on the switch terminals should keep good after storage guarantee date
要求贮存期后开关端子部分上锡仍然良好。

Normal Condition:

Ambient temperature 环境温度: 20±2℃

Relative humidity 相对湿度: 65%±5% R.H.;

Air pressure 气压: 86~101KPa;

4. Ratings/额定性能要求

Rating 额定负荷: 12V AC/DC max. 2V DC min.
10mA AC/DC max. 10 μ A DC min.;

Insulation Resistance 绝缘电阻: ≥100MΩ/DC 100V;

Withstand Voltage 耐电压: 100 AC 1 Minute;

Mechanical Life 机械寿命: 80,000,000 Cycles.

5. Profile Dimensions /外形尺寸

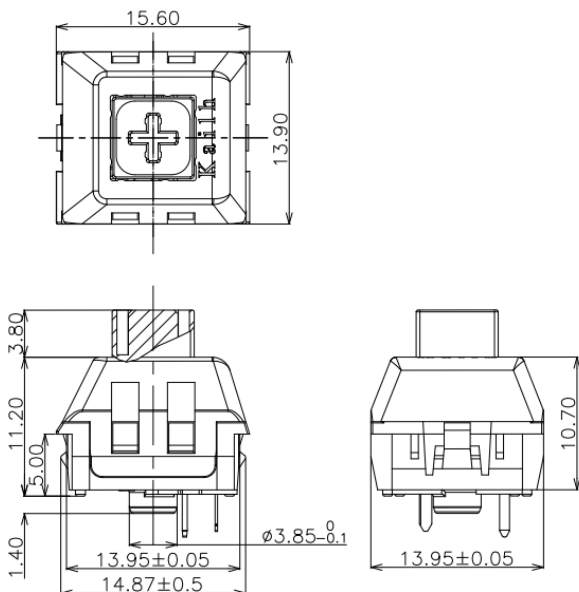



6. Electrical Performance/电气性能

Item 项目	Description 项目描述	Test Condition 测试条件	Requirement 规格要求
6.1	Contact Resistance 接触电阻	<p>Static load: (Operation force)x2, which is applied on the center of Switch stem.Be measured when the switch contact stabilization. 静态负载：动作力的 2 倍，施加在手柄中心。开关接触稳定时量测。</p> <p>Measurement tool: Contact resistance Meter. 测量工具：微电流接触电阻计(1KHz, 20mV,5~50mA)</p> <p>在低电流 (≤100mA) 条件下测试。 Measured at low current (100mA or less).</p>	<p>200mΩ Max 200mΩ 以下</p>
6.2	Insulation Resistance 绝缘电阻	<p>Apply a Voltage of DC 100 V for 1 minute, according to the below method. (1) Between terminals. (2) Between terminal and Body.</p> <p>输入 100V DC 电压 1 分钟，按如下接触方法测试： (1) 端子与端子之间。 (2) 端子与外壳之间。</p>	<p>100MΩ Min 100 兆欧以上</p>
6.3	Dielectric withstanding voltage 耐电压	<p>Apply a Voltage of AC100 V (50~60Hz) for 1 minute, according to the below method. (1) Between terminals. (2) Between terminal and Body.</p> <p>输入 100V AC 电压 1 分钟，按如下接触方法测试： (1) 端子与端子之间。 (2) 端子与外壳之间。</p>	<p>No evidence of breakdown 无瞬断、击穿等破坏。</p>
6.4	Bouncing 触点抖动	<p>Operation speed: 3~4 times/s 操作速度：每秒 3~4 次</p> <p>Oscillo scope 示波器 Switch Bouncing Test Circuit 抖动测定回路。</p> <p>Switch Bouncing Test Circuit 抖动测定回路</p> <p>"ON" "OFF"</p>	<p>Before Life cycle: On:5ms MAX,5 毫秒以下 Off: 5ms MAX,5 毫秒以下</p> <p>After Life cycle: On:10ms MAX,10 毫秒以下 Off: 10ms MAX,10 毫秒以下</p>

7. Mechanical Performance/机械性能

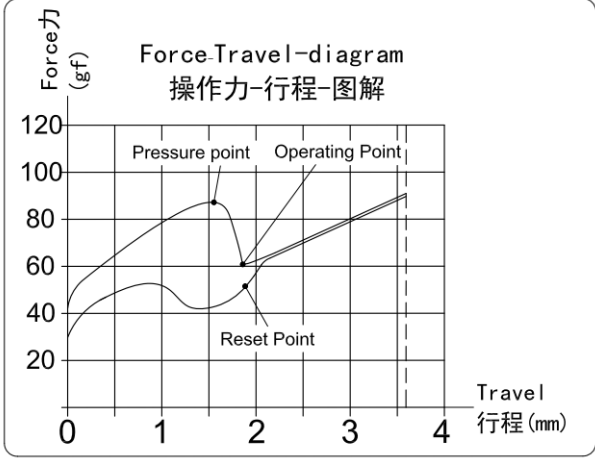
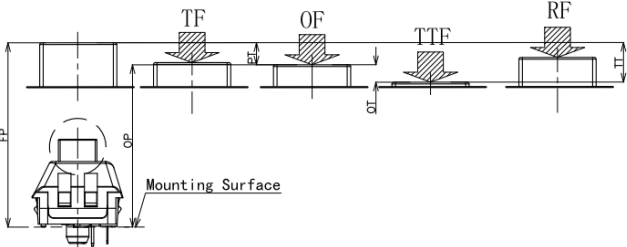
Item 项目	Description 项目描述	Test Condition 测试条件	Requirement 规格要求
7.1	Load Curve 荷重曲线	<p>Place the vertical direction of switch operation and gradually increase the load applied to the center of the stem until it stop. 开关的动作方向为垂直放置，向手柄中心逐渐施加负荷直到停止.</p> 	See page 11 见第 11 页
7.2	Loading parameter 荷重参数	<p>Place the vertical direction of switch operation and gradually increase the load applied to the center of the stem until it stop. 开关的动作方向为垂直放置，向手柄中心逐渐施加负荷直到停止.</p> 	See page 11 见第 11 页

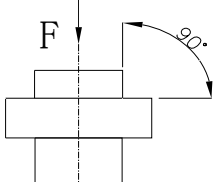
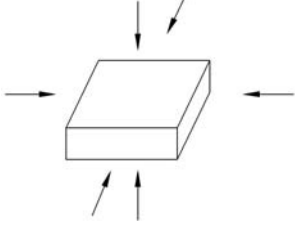

7.3	Static Strength 静止强度	<p>A static load of 3kgf shall be applied in the direction of button operation for a period of 60 seconds. 在手柄动作方向施加 3kgf 的静负荷 60 秒, 然后测试参数.</p> 	<p>No damage (Electrical) And mechanical) 电气和机械性能正常.</p>
7.4	Stem Pull Strength 手柄拉拔强度	<p>Break by a pull force applied opposite to the direction of stem operation. 在推柄动作方向反向垂直施加拉力, 使其破坏的程度.</p>	<p>5kgf Min</p>
7.5	Shock 机械冲击	<p>Measured by according to the below condition: (1) Acceleration: 80g 加速度 (2) Cycles of test:3 cycles each in 6 directions, for a total of 18 cycles. 试验次数: 每个方向 3 次, 6 个方向共 18 次.</p> 	<p>Shall meet No.6, 7.1, 7.2. 满足 6, 7.1, 7.2 要求.</p>
7.6	Life Test 寿命测试	<ol style="list-style-type: none"> 1) D.C.12V 10mA resistance load D.C 12V 10mA 电阻负荷 2) Operation speed : 5-6 times / s 动作速度: 5-6 次/ 秒 3) Push force : 150gf 按力: 150gf 5) Push travel : 3.6mm 按压行程: 3.6mm 6) Operation number: 80,000,000cycles 动作次数: 80, 000, 000 次 	<p>Contact resistance: 1 Ω Max 接触电阻: 1 欧以下 Bouncing: 10ms Max 触点抖动: 10 毫秒以下 Operation force: Variation rate within ± 30% 操作力的变化范围在初始值的±30%以内.</p>



8. Environmental Performance/环境性能

Item 项目	Description 项目描述	Test Condition 测试条件	Requirement 规格要求															
8.1	Cold test 耐寒性	(1) Temperature : - 20±2℃ 温度: - 20±2℃ (2) Duration of test: 48h 持续时间: 48 小时 (3) Take off a drop water 去掉水珠 (4) Standard conditions after test : 1h 试验后的放置条件: 1 小时	Contact resistance: 200mΩ Max Shall meet : No. 6.2 to 6.4 No. 7.1 to 7.2 接触电阻 200mΩ 以下 满足: No. 6.2 to 6.4 No. 7.1 to 7.2															
8.2	Heat test 耐热性	(1) Temperature : 70±2℃ 温度: 70±2℃ (2) Duration of test: 48h 持续时间: 48 小时 (3) Take off a drop water 去掉水珠 (4) Standard conditions after test : 1h 试验后的放置条件: 1 小时	Contact resistance: 200mΩ Max Shall meet : No. 6.2 to 6.4 No. 7.1 to 7.2 接触电阻 200mΩ 以下 满足: No. 6.2 to 6.4 No. 7.1 to 7.2															
8.3	Temperature cycle 温度循环	(1) Test cycles: 5 cycles 试验周期: 5 个周期 (2) Standard condition after test:1h 试验后的放置条件: 1 小时 <table border="1" data-bbox="432 1368 1037 1559"> <thead> <tr> <th></th> <th>Temperature 温度</th> <th>Duration of test 持续时间</th> </tr> </thead> <tbody> <tr> <td>1 cycle 一次循环</td> <td>20±5℃</td> <td>1h</td> </tr> <tr> <td></td> <td>-20±5℃</td> <td>1h</td> </tr> <tr> <td></td> <td>20±5℃</td> <td>1h</td> </tr> <tr> <td></td> <td>70±5℃</td> <td>1h</td> </tr> </tbody> </table>		Temperature 温度	Duration of test 持续时间	1 cycle 一次循环	20±5℃	1h		-20±5℃	1h		20±5℃	1h		70±5℃	1h	Contact resistance: 200mΩ Max Shall meet : No. 6.2 to 6.4 No. 7.1 to 7.2 接触电阻 200mΩ 以下 满足: No. 6.2 to 6.4 No. 7.1 to 7.2
	Temperature 温度	Duration of test 持续时间																
1 cycle 一次循环	20±5℃	1h																
	-20±5℃	1h																
	20±5℃	1h																
	70±5℃	1h																
8.4	Soldering heat test 耐焊接热	Soldering area: T/2 of PWB thickness. (PWB: T=1.6mm) 焊接面积: 印刷基板的 1/2 厚度处 Soldering temperature: 260±5℃ Soldering time: 3±0.5s 焊接温度: 260±5℃ 焊接时间: 3±0.5 秒	Appearance: No abnormality. 外观无异常															

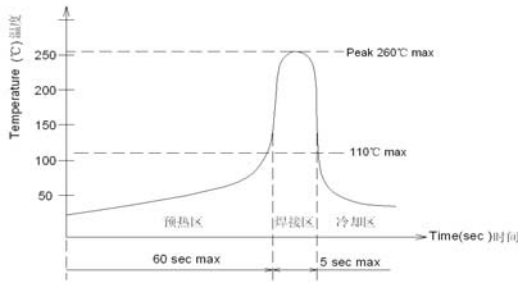

8.5	Solder ability 可焊性	<p>1. Hand soldering 手工焊接: Please practice according to below condition: (1) Soldering Temperature : $350 \pm 5^{\circ}\text{C}$ 焊接温度: $350 \pm 5^{\circ}\text{C}$ (2) Continual soldering time: $3 \pm 0.5\text{s}$ 连续焊接时间: 3 ± 0.5 秒 (1) Capacity of soldering iron: $\leq 20\text{w}$ 电烙铁功率: 20 瓦以下</p> <p>2. Automatic PIP soldering 自动插板焊接: For the product of T/H according to below condition:</p> <p style="text-align: center;">波峰焊温度曲线图(单波峰)</p> 	At least 95% of surface area of immersed portion shall be covered by solder. 浸焊面积大于 90%以上.	
8.6	Humidity test 耐湿性	<p>(1) Temperature : $60 \pm 2^{\circ}\text{C}$ 温度: $60 \pm 2^{\circ}\text{C}$ (2) relative humidity: 90~95% R.H. 相对湿度:90~95% R.H. (3) Duration of test: 48h 持续时间: 48 小时 (4) Take off a drop water 去掉水珠 (5) Standard conditions after test: 1h 试验后的放置条件: 1 小时</p>	Contact resistance: $200\text{m}\Omega$ Max Shall meet : No. 6.2 to 6.4 No. 7.1 to 7.2 接触电阻 $200\text{m}\Omega$ 以下满足: No. 6.2 to 6.4 No. 7.1 to 7.2	
8.7	Salt Spray 盐雾测试	<p>Apply the following environment to test: 根据下列条件进行测试: (1) Temperature : $35 \pm 5^{\circ}\text{C}$ 温度: $35 \pm 5^{\circ}\text{C}$; (2) Salt water density: $5 \pm 1\%$ 盐水浓度: $5 \pm 1\%$; (3) Duration: 12hours 持续时间: 12 小时; (4) After test, the salt deposit shall be removed by running water. 实验后将盐沉积物用水冲掉</p>	Appearance: No corrosion spot, no crack, no base plate naked. 外观: 无腐蚀点, 无裂纹, 无裸露基材. Contact Resistance: $200\text{m}\Omega$ Max 接触电阻: 200 毫欧以下	



P/N: CPG1511F01S09-1	DOC. No.: KH-PS1803-33	Rev.: B	Page: 9/11
--------------------------------	----------------------------------	-------------------	----------------------

8.8	Protection Against ingress of dust(IP5X) 防尘	<p>The switches are placed in a position of normal use inside the test chamber. The test is carried out according to the second enclosure of IEC60529/GB4208. The test shall be continued for a period of 8h.</p> <p>测试样品以正常使用位置在防尘箱中安装；按 IEC60529 或 GB4208 防护标准测试条件进行试验；试验应持续 8 小时；</p>	<p>After test: Operating is normal Between terminals, terminal and surface of the crust, Dielectric withstand in voltage $\geq 100V$</p> <p>动作正常； 端子之间及端子与外壳表面耐电压强度$\geq 100V$</p>
8.9	Protection against ingress water(IPX6) 防水	<p>The switches are placed in a position of normal use inside the test table. The test is carried out according to the second enclosure of IEC60529/GB4208.</p> <p>测试样品以正常使用位置在防尘箱中安装；按 IEC60529 或 GB4208 防护标准测试条件进行试验；</p>	<p>After test: Operating is normal. Water don't enter electric parts of the switch inside. Between terminals, terminal and surface of the crust, Dielectric withstand in voltage $\geq 100V$</p> <p>动作正常； 水不能进入开关内带电部份 端子之间及端子与外壳表面耐电压强度$\geq 100V$</p>

9. Recommended PCB Layout 推荐的 PCB 安装焊盘规格

Mounting Options 安装选项

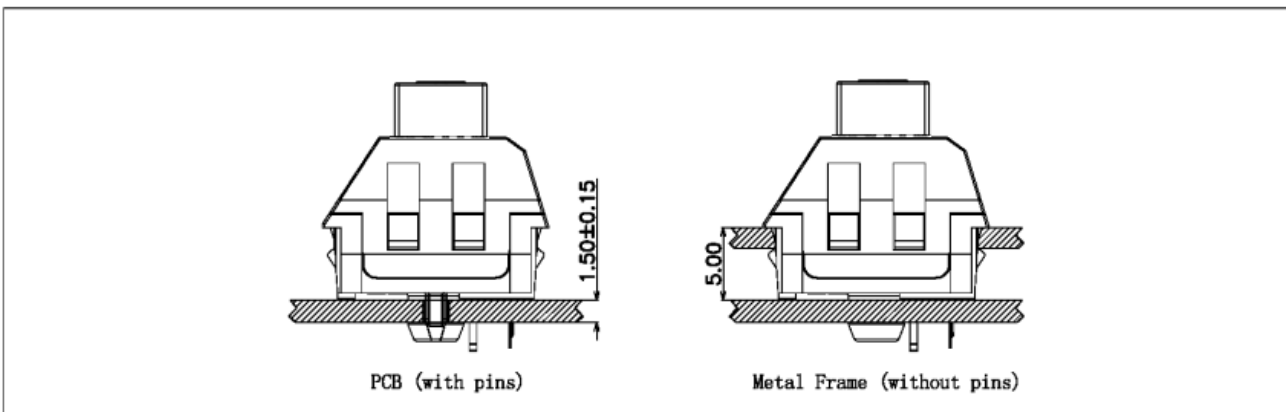

Circuit Board Layouts 电路板布局

Grid line spacing = 1.27mm 网格线间距= 1.27毫米

Keyswitch without fixation pins
按键开关不带定位柱

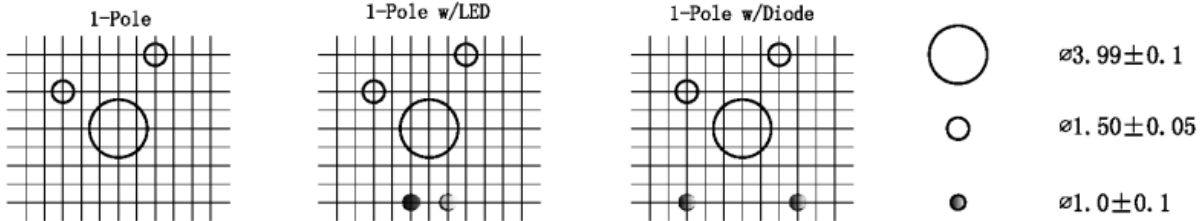

Keyswitch with fixation pins
按键开关带定位柱

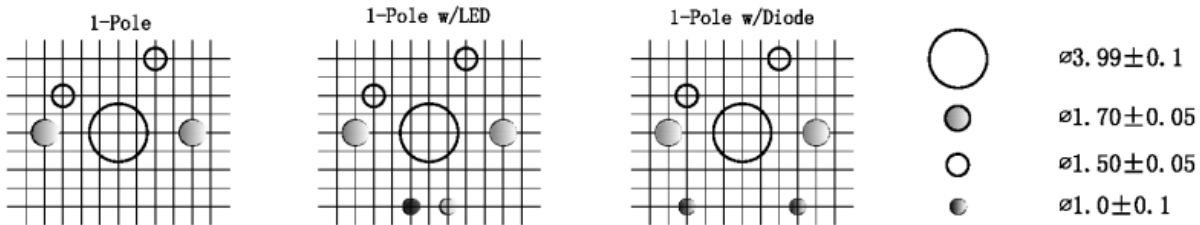

Metal Frame Cutout Dimensions

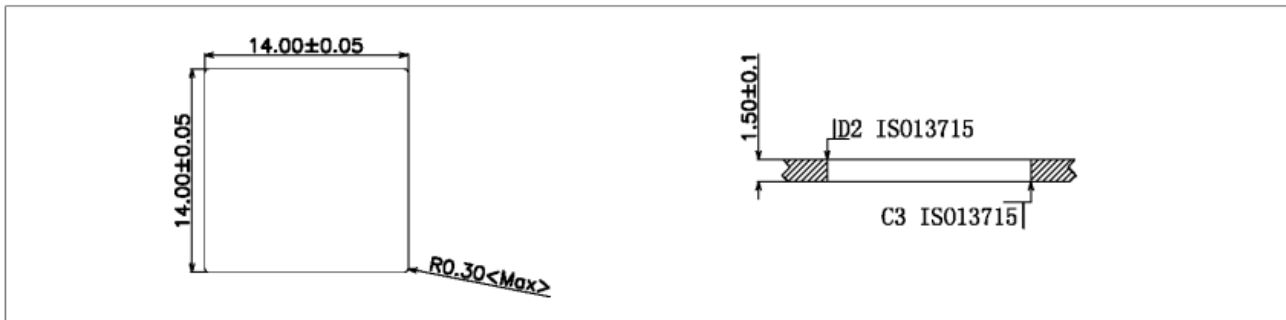

10. Loading Parameter (TT/PT/OT /OF/TF/RF) Specification 荷重参数规格：

Parameter	Unit	Specification	Remark
TT(总行程)	mm	3.60±0.3	
PT(导通行程)	mm	1.80±0.3	
OT(过行程)	mm	1.30	Min.
OF(动作力)	gf	60±15	
TF(触感力)	gf	95±15	
RF(回弹力)	gf	15	Min.

11. Packaging 包装

Packaging type: Tray, 1000Pcs/Tray, 4000Pcs/Carton.

包装方式: Tray 盘,1000Pcs/盘, 4000Pcs/箱.

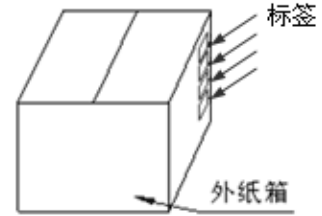
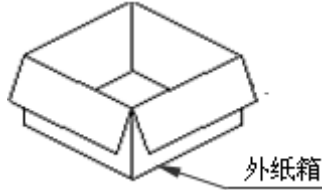

12. Precaution 注意事项

12.1 Immersion Soldering condition 浸焊条件

ITEM 项目	CONDITION 条件
Preheat temperature 预热温度	110°C Max (Ambient temperature of soldering surface of P.W.B) 110°C 以下(印刷基板焊锡面周围的温度)
Preheat time 预热时间	60s, Max 60 秒以内
Area of flux 助焊剂面积	1/2 Max of PWB Thickness 印刷基板厚度的 1/2 以内
Temperature of solder 焊锡温度	260±5°C 260±5°C
Time of immersion 浸焊时间	3s±0.5s 3s±0.5s
Number of soldering 焊接次数	2time Max (But should down heat of the first soldering) 2 次以内
Printed wiring board 印刷基板	Single side copper-clad laminates 单面铜箔

- (1) After switches were soldered, please be careful not to clean switches with solvent
开关浸焊后,注意不要用溶剂清洗.
- (2) Under the condition of using soldering iron, soldering temperature shall be 350°C±5°C with 3±0.5s.
在使用烙铁的情况下,焊锡温度应在350°C±5°C,焊接时间3±0.5秒.

12.2 Notes 注意点

- (1) Please be cautious not to give excessive static load or shock to switches.
注意不要施加超负荷的压力或晃动开关.
- (2) Please be careful not to stack up P. W. B. after switches were soldered.
开关焊接以后,印刷基板注意不要叠放.
- (3) Preservation under high temperature and high humidity or corrosive gas should be avoided
Especially. When you need to preserve for a long period, do not open the carton.
保管时尤其应注意避开高湿高温和有腐蚀性气体的环境.如需长时间保存,请不要打开包装箱.
- (4) Products meet the ROHS & REACH environmental management substances control standards
产品满足 ROHS & REACH 环境管理物质管制标准

Looking for pricing, stock, or lifecycle information?

Click below to explore more details on WIN SOURCE:

- [View 5150 on WIN SOURCE](#)
- [Adafruit Industries LLC Information](#)

Optimize Your Supply Chain with WIN SOURCE Solutions

- ✓ Global Sourcing Solution
- ✓ Obsolete Management
- ✓ Cost Control Management
- ✓ Shortage Management
- ✓ Alternative Solution
- ✓ Excess Inventory Management