



**THE DATASHEET OF  
ADM101EARM-REEL7**



**FEATURES**

- 460 kbit/s Transmission Rate
- Single 5 V Power Supply
- Compatible with RS-232 Input/Output Levels
- 0.1  $\mu$ F Charge Pump Capacitors
- One Driver and One Receiver
- On-Board DC-DC Converter
- $\pm 4.2$  V Output Swing with 5 V Supply
- Low Power BiCMOS: 500  $\mu$ A  $I_{CC}$
- Ultralow Power (1  $\mu$ A) Shutdown Mode
- 10-Lead MSOP Package
- Qualified for Automotive Applications

**APPLICATIONS**

- Mobile Telephones
- Palmtop Computers
- PDA's
- Portable Instrumentation
- GPS Receivers

**GENERAL DESCRIPTION**

The **ADM101E** is a single channel RS-232 driver and receiver in the Analog Devices Craft Port series, designed to operate from a single, 5 V supply. A highly efficient charge-pump voltage inverter generates an on-chip  $-5$  V supply, which eliminates the need for a negative power supply for the driver and permits RS-232 compatible output levels to be developed using charge pump capacitors as small as 0.1  $\mu$ F.

A shutdown input disables the charge pump and puts the device into a low power shutdown mode, in which the current consumption is typically less than 1  $\mu$ A. The transmitter is disabled during shutdown but the receiver remains functional.

**FUNCTIONAL BLOCK DIAGRAM**

Figure 1.

An epitaxial BiCMOS construction minimizes power consumption to 3 mW and also guards against latch-up. Overvoltage protection is provided allowing the receiver inputs to withstand continuous voltages in excess of  $\pm 30$  V. In addition, all I-O pins have ESD protection to levels greater than 15 kV.

The **ADM101E** is available in a 10-lead MSOP package, which makes it ideal for serial communications in small, portable applications such as palmtop computers and mobile telephones, where a full, RS-232 serial interface is not required, but compact size and low power drain are paramount.

Craft Port is a trademark of Analog Devices, Inc.

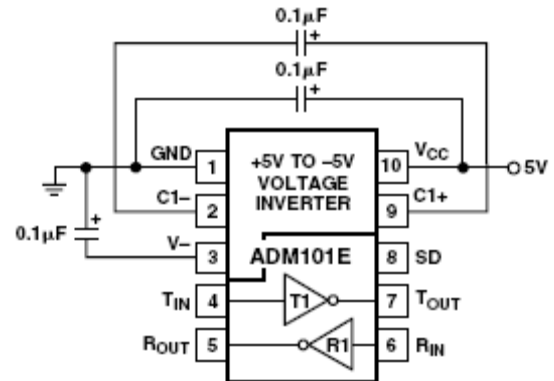
Rev. B

[Document Feedback](#)

Information furnished by Analog Devices is believed to be accurate and reliable. However, no responsibility is assumed by Analog Devices for its use, nor for any infringements of patents or other rights of third parties that may result from its use. Specifications subject to change without notice. No license is granted by implication or otherwise under any patent or patent rights of Analog Devices. Trademarks and registered trademarks are the property of their respective owners.

One Technology Way, P.O. Box 9106, Norwood, MA 02062-9106, U.S.A.  
Tel: 781.329.4700 ©2001–2014 Analog Devices, Inc. All rights reserved.  
[Technical Support](#) [www.analog.com](http://www.analog.com)

## TABLE OF CONTENTS

Features .....	1	General Description .....	8
Applications .....	1	Circuit Description .....	9
Functional Block Diagram .....	1	Charge Pump DC-DC Converter .....	9
General Description .....	1	Charge Pump Capacitors and Supply Decoupling .....	9
Revision History .....	2	Transmitter (Driver) Section .....	9
Specifications .....	3	Receiver Section .....	9
Absolute Maximum Ratings .....	4	Shutdown Input .....	10
ESD Caution .....	4	Outline Dimensions .....	11
Pin Configuration and Function Descriptions .....	5	Ordering Guide .....	11
Typical Performance Characteristics .....	6	Automotive Products .....	11

## REVISION HISTORY

### 3/14—Rev. A to Rev. B

Added Automotive Model .....	Throughout
Changed $\mu$ SOIC Package to MSOP Package .....	Throughout
Updated Outline Dimensions .....	11
Changes to Ordering Guide .....	11
Added Automotive Products Section .....	11

### 2/01—Rev. 0 to Rev. A

Changes made to Outline Dimensions (RM-10) .....	6
--	---

## SPECIFICATIONS

$V_{CC} = 5\text{ V} \pm 10\%$ ,  $C1 = C2 = 0.1\ \mu\text{F}$ . All specifications  $T_{MIN}$  to  $T_{MAX}$  unless otherwise noted.

Table 1.

Parameter	Min	Typ	Max	Unit	Test Conditions/Comments
Output Voltage Swing	$\pm 3.5$	$\pm 4.2$		V	$V_{CC} = 5\text{ V} \pm 5\%$ , $T_{OUT}$ Loaded with $3\text{ k}\Omega$ to GND
	$\pm 3.25$	$\pm 4.2$		V	$V_{CC} = 5\text{ V} \pm 10\%$ , $T_{OUT}$ Loaded with $3\text{ k}\Omega$ to GND
$V_{CC}$ Power Supply Current (Unloaded)		0.5	1	mA	No Load, $T_{IN} = V_{CC}$ or GND
$V_{CC}$ Power Supply Current (Loaded)		1.85	2.5	mA	$T_{OUT}$ Loaded with $3\text{ k}\Omega$ to GND
$V_{CC}$ Power Supply Current (Shutdown)			1	$\mu\text{A}$	SD Input = $V_{CC}$
Input Logic Threshold Low, $V_{INL}$			0.8	V	
Input Logic Threshold High, $V_{INH}$	2.4			V	
Input Leakage Current			$\pm 1$	$\mu\text{A}$	
RS-232 Input Voltage Range	-15		+15	V	
RS-232 Input Threshold Low	0.8	2.2		V	
RS-232 Input Threshold High		2.4	2.6	V	
RS-232 Input Hysteresis		0.2		V	
RS-232 Input Resistance	3	5	7	$\text{k}\Omega$	
TTL/CMOS Output Voltage Low, $V_{OL}$			0.4	V	$I_{OUT} = 1.6\text{ mA}$
TTL/CMOS Output Voltage High, $V_{OH}$	3.5			V	$I_{OUT} = -1.0\text{ mA}$
Propagation Delay		0.25		$\mu\text{s}$	RS-232 to TTL
Instantaneous Slew Rate <sup>1</sup>		25		$\text{V}/\mu\text{s}$	$C_L = 10\text{ pF}$ , $R_L = 3\text{ k}\Omega - 7\text{ k}\Omega$ , $T_A = 25^\circ\text{C}$
Transition Region Slew Rate		11		$\text{V}/\mu\text{s}$	$R_L = 3\text{ k}\Omega$ , $C_L = 1000\text{ pF}$
					Measured from +3 V to -3 V or Vice Versa
Baud Rate	460			kB	$R_L = 3\text{ k}\Omega$ , $C_L = 1\text{ nF}$
Output Resistance	300			$\Omega$	$V_{CC} = 0\text{ V}$ , $V_{OUT} = \pm 2\text{ V}$
RS-232 Output Short Circuit Current		$\pm 25$	$\pm 60$	mA	

<sup>1</sup> Sample tested to ensure compliance.

## ABSOLUTE MAXIMUM RATINGS

$T_A = 25^\circ\text{C}$  unless otherwise noted.

**Table 2.**

Parameter	Rating
$V_{CC}$	6 V
$V_-$	+0.3 V to -6 V
Input Voltages	
Driver Input $T_{IN}$	-0.3 V to ( $V_{CC}$ , +0.3 V)
Receiver Input $R_{IN}$	$\pm 30$ V
Output Voltages	
Driver Output $T_{OUT}$	( $V_{CC}$ , +0.3 V) to ( $V_-$ , -0.3 V)
Receiver Output $R_{OUT}$	-0.3 V to ( $V_{CC}$ +0.3 V)
Short Circuit Duration	
$T_{OUT}$	Continuous
Power Dissipation	
RM-10 (Derate 12 mW/ $^\circ\text{C}$ above 70 $^\circ\text{C}$ )	1488 mW
Thermal Impedance	135 $^\circ\text{C}/\text{W}$
Operating Temperature Range	
Industrial (A Version)	-40 $^\circ\text{C}$ to +85 $^\circ\text{C}$
Storage Temperature Range	-65 $^\circ\text{C}$ to +150 $^\circ\text{C}$
Lead Temperature Soldering	
Vapor Phase (60 sec)	215 $^\circ\text{C}$
Infrared (15 sec)	220 $^\circ\text{C}$
ESD Rating	>2000 V
ESD Rating (I-O Pins)	15 kV

Stresses above those listed under Absolute Maximum Ratings may cause permanent damage to the device. This is a stress rating only; functional operation of the device at these or any other conditions above those indicated in the operational section of this specification is not implied. Exposure to absolute maximum rating conditions for extended periods may affect device reliability.

### ESD CAUTION



**ESD (electrostatic discharge) sensitive device.** Charged devices and circuit boards can discharge without detection. Although this product features patented or proprietary protection circuitry, damage may occur on devices subjected to high energy ESD. Therefore, proper ESD precautions should be taken to avoid performance degradation or loss of functionality.

## PIN CONFIGURATION AND FUNCTION DESCRIPTIONS

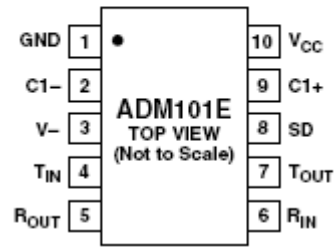

Figure 2. Pin Configuration

Table 3. Pin Function Descriptions

Pin No.	Mnemonic	Function
1	GND	Ground Pin. Must be connected to 0 V.
2	C1-	Negative Terminal of C1 (if C1 is Polarized Capacitor).
3	V-	Internally Generated Negative Supply Voltage.
4	T <sub>IN</sub>	Driver Input (3 V to 5 V TTL/CMOS Logic Levels).
5	R <sub>OUT</sub>	Receiver Output (3 V to 5 V TTL/CMOS Logic Levels).
6	R <sub>IN</sub>	Receiver Input (EIA-232 Signal Levels).
7	T <sub>OUT</sub>	Driver Output (EIA-232 Signal Levels).
8	SD	Shutdown Input. Logic 1 on this input puts the <a href="#">ADM101E</a> into low power shutdown mode.
9	C1+	Positive Terminal of Charge Pump Capacitor (if C1 is Polarized Capacitor).
10	V <sub>CC</sub>	Positive Power Supply, Nominally 5 V.

TYPICAL PERFORMANCE CHARACTERISTICS

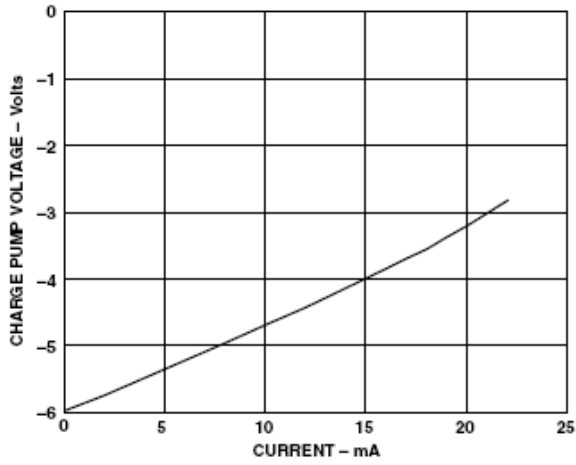

Figure 3. Charge Pump Voltage vs. Current

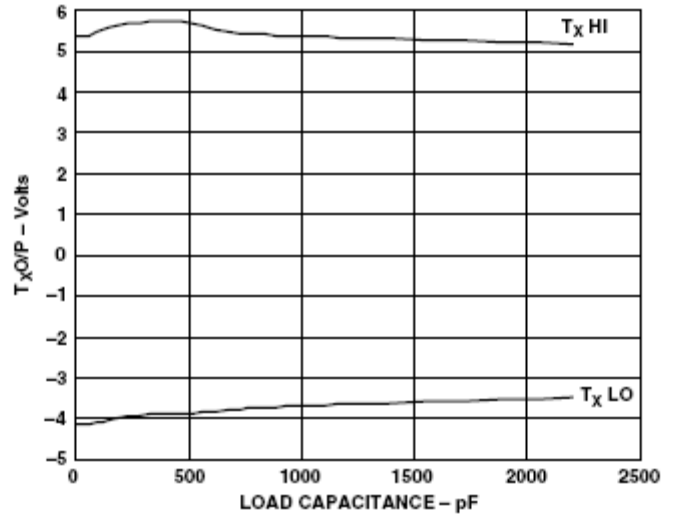

Figure 5. Transmitter Output Voltage vs. Load Capacitance at 460 kbps

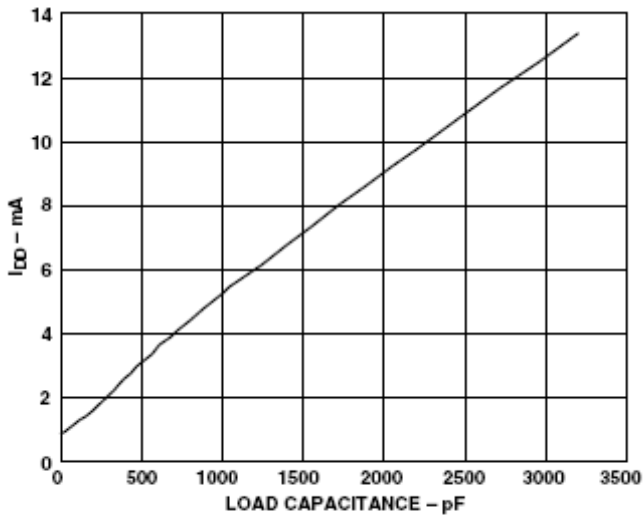

Figure 4. I<sub>DD</sub> vs. Load Capacitance at 460 kbps

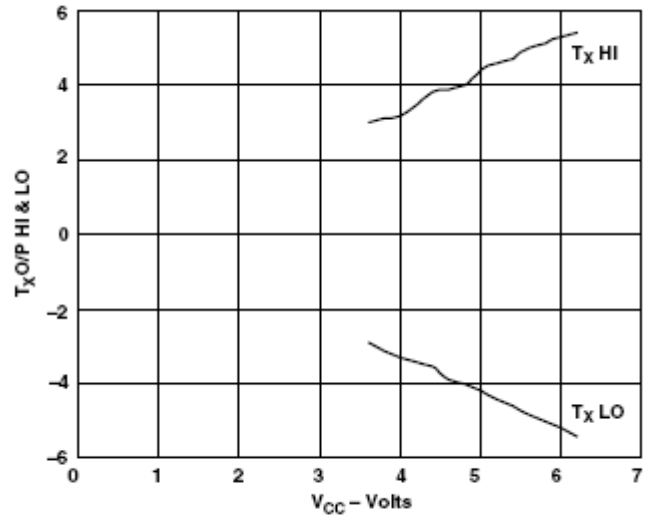

Figure 6. Tx Output Voltage vs. Supply

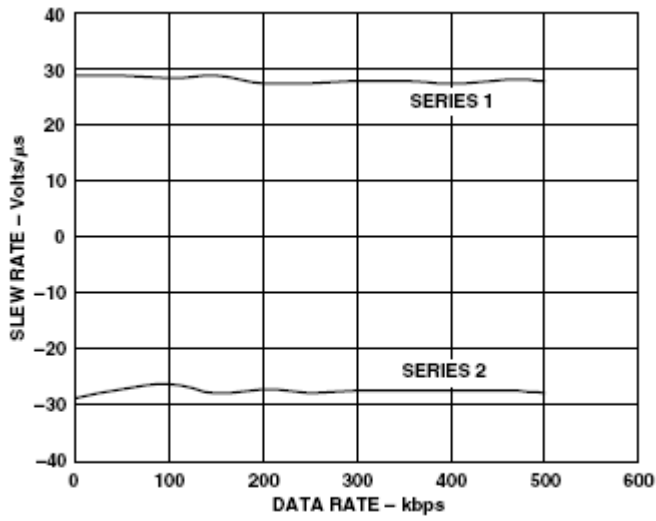

Figure 7. Slew Rate vs. Data Rate

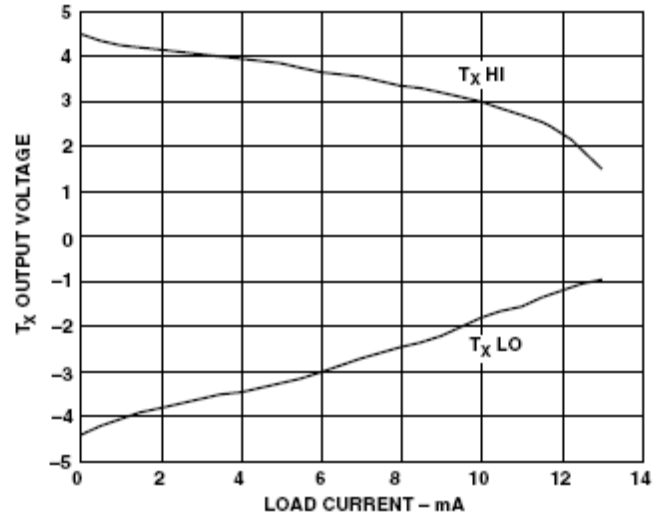

Figure 8. Transmitter Output Voltage vs. Load Current

## GENERAL DESCRIPTION

The [ADM101E](#) is an RS-232 compatible line driver/receiver in the Analog Devices Craft Port series, containing one driver (transmitter) and one receiver. It is ideal for serial communication in small portable devices such as mobile telephones, palmtop personal computers and personal digital assistants, where a full, RS-232 serial interface is not required, and only Tx and Rx lines are required for low speed communication between devices.

The [ADM101E](#) operates from a single, 5 V supply, and generates its own, on-chip, -5 V power supply, thus removing the need for a negative power supply for the driver.

## CIRCUIT DESCRIPTION

The internal circuitry consists of three main sections. These are:

1. A charge pump dc-to-dc converter.
2. 5 V logic to EIA-232 driver.
3. EIA-232 to 5 V logic receiver.

### CHARGE PUMP DC-DC CONVERTER

The dc-dc converter generates a negative supply voltage from the 5 V supply, thus removing the need for a separate  $-5$  V rail. It consists of an on-chip 200 kHz oscillator, switching matrix and two external capacitors, as shown in Figure 9.

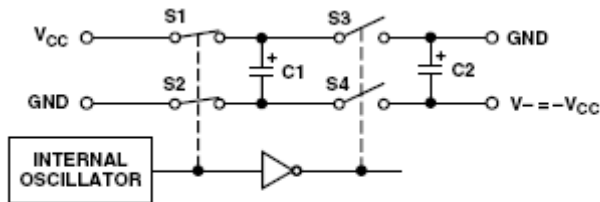

Figure 9. Charge Pump DC-DC Converter

When S1 and S2 are closed, S3 and S4 are open, and C1 charges to  $+V_{CC}$ . S1 and S2 are then opened, while S3 and S4 are closed to connect C1 across C2, dumping charge into C2. Since the positive terminal of C2 is at ground, a negative voltage will be built up on its negative terminal with each cycle of the oscillator. This voltage depends on the current drawn from C2. If the current is small, the voltage will be close to  $-V_{CC}$ , but will fall as the current drawn increases.

### CHARGE PUMP CAPACITORS AND SUPPLY DECOUPLING

For proper operation of the charge pump, the capacitors should have an equivalent series resistance (ESR) less than  $1 \Omega$ . As the charge pump draws current pulses from  $V_{CC}$ , the  $V_{CC}$  decoupling capacitor should also have low ESR. The  $V_{CC}$  decoupling capacitor and  $V-$  reservoir capacitor should also have low ESR because they determine how effectively ESD pulses are clamped to  $V_{CC}$  or  $V-$  by the on-chip clamp diodes. Tantalum or monolithic ceramic capacitors are suitable for these components. If using tantalum capacitors, do not forget to observe polarity.

### TRANSMITTER (DRIVER) SECTION

The driver converts 5 V logic input levels into RS-232 compatible output levels. With  $V_{CC} = 5$  V and driving an EIA-232 load, the output voltage swing is typically  $\pm 4.2$  V.

### RECEIVER SECTION

The receivers are inverting level-shifters that accept EIA-232 input levels and translate them into 5 V logic output levels. The inputs have internal  $5 \text{ k}\Omega$  pull-down resistors to ground and are also protected against overvoltages of up to  $\pm 25$  V. The guaranteed switching thresholds are 0.8 V minimum and 2.8 V maximum. An unconnected receiver input is pulled to 0 V by the internal  $5 \text{ k}\Omega$  pull-down resistor. This, therefore, results in a Logic 1 output level for unconnected inputs or for inputs connected to GND.

The receivers have Schmitt trigger input with a hysteresis level of 0.25 V. This ensures error-free reception for both noisy inputs and for inputs with slow transition times.

## SHUTDOWN INPUT

The shutdown input allows the [ADM101E](#) to be put into an ultralow power mode where the dc-dc converter is switched off and the transmitter is disabled. The receiver remains active during shutdown. Logic 0 at this input enables the [ADM101E](#), while a Logic 1 at this input shuts down the [ADM101E](#).

## OUTLINE DIMENSIONS

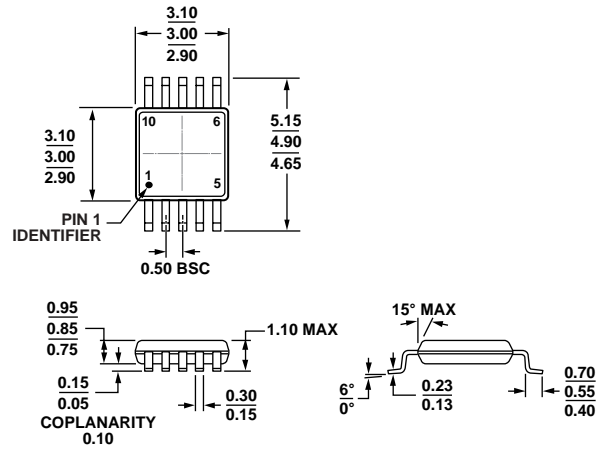

COMPLIANT TO JEDEC STANDARDS MO-187-BA

Figure 10. 10-Lead Mini Small Outline Package [MSOP] (RM-10)

Dimensions shown in millimeters

091709-A

## ORDERING GUIDE

Model <sup>1,2</sup>	Temperature Range	Package Description	Package Option	Branding Code
ADM101EARM	-40°C to +85°C	10-Lead Mini Small Outline Package [MSOP]	RM-10	M01
ADM101EARM-REEL	-40°C to +85°C	10-Lead Mini Small Outline Package [MSOP]	RM-10	M01
ADM101EARM-REEL7	-40°C to +85°C	10-Lead Mini Small Outline Package [MSOP]	RM-10	M01
ADM101EARMZ	-40°C to +85°C	10-Lead Mini Small Outline Package [MSOP]	RM-10	M1
ADM101EARMZ-REEL	-40°C to +85°C	10-Lead Mini Small Outline Package [MSOP]	RM-10	M1
ADM101EARMZ-REEL7	-40°C to +85°C	10-Lead Mini Small Outline Package [MSOP]	RM-10	M1
ADM101EWARMZ-REEL7	-40°C to +85°C	10-Lead Mini Small Outline Package [MSOP]	RM-10	M1

<sup>1</sup> Z = RoHS Compliant Part.

<sup>2</sup> W = Qualified for Automotive Applications.

## AUTOMOTIVE PRODUCTS

The [ADM101EW](#) models are available with controlled manufacturing to support the quality and reliability requirements of automotive applications. Note that these automotive models may have specifications that differ from the commercial models; therefore, designers should review the Specifications section of this data sheet carefully. Only the automotive grade products shown are available for use in automotive applications. Contact your local Analog Devices account representative for specific product ordering information and to obtain the specific Automotive Reliability reports for these models.

**NOTES**

## Looking for pricing, stock, or lifecycle information?

Click below to explore more details on WIN SOURCE:

- ⊖ [View ADM101EARM-REEL7 on WIN SOURCE](#)
- ⊖ [Analog Devices Inc. Information](#)

## Optimize Your Supply Chain with WIN SOURCE Solutions

- ✓ Global Sourcing Solution
- ✓ Obsolete Management
- ✓ Cost Control Management
- ✓ Shortage Management
- ✓ Alternative Solution
- ✓ Excess Inventory Management