

FEATURES

- RF frequency range of 500 MHz to 1700 MHz
- IF frequency range of 30 MHz to 450 MHz
- Power conversion gain: 8.3 dB
- SSB noise figure of 9.9 dB
- SSB noise figure with 5 dBm blocker of 23 dB
- Input IP3 of 25.2 dBm
- Input P1dB of 10.6 dBm
- Typical LO drive of 0 dBm
- Single-ended, 50 Ω RF and LO input ports
- High isolation SPDT LO input switch
- Single-supply operation: 3.3 V to 5 V
- Exposed paddle, 6 mm × 6 mm, 36-lead LFCSP

APPLICATIONS

- Cellular base station receivers
- Transmit observation receivers
- Radio link downconverters

GENERAL DESCRIPTION

The ADL5358 uses a highly linear, doubly balanced, passive mixer core along with integrated RF and local oscillator (LO) balancing circuitry to allow single-ended operation. The ADL5358 incorporates the RF baluns, allowing for optimal performance over a 500 MHz to 1700 MHz RF input frequency range. Performance is optimized for RF frequencies from 500 MHz to 1200 MHz using a high-side LO and RF frequencies from 1200 MHz to 1700 MHz using a low-side LO. The balanced passive mixer arrangement provides good LO-to-RF leakage, typically better than -20 dBm, and excellent intermodulation performance. The balanced mixer core also provides extremely high input linearity, allowing the device to be used in demanding cellular applications where in-band blocking signals may otherwise result in the degradation of dynamic performance. A high linearity IF buffer amplifier follows the passive mixer core to yield a typical power conversion gain of 8.3 dB and can be used with a wide range of output impedances.

The ADL5358 provides two switched LO paths that can be used in TDD applications where it is desirable to ping-pong between two local oscillators. LO current can be externally set using a resistor to minimize dc current commensurate with the desired level of performance. For low voltage applications, the ADL5358 is capable of operation at voltages down to 3.3 V with substantially reduced current. Under low voltage operation, an additional logic pin is provided to power down (<300 μA) the circuit when desired.

Rev. 0

Information furnished by Analog Devices is believed to be accurate and reliable. However, no responsibility is assumed by Analog Devices for its use, nor for any infringements of patents or other rights of third parties that may result from its use. Specifications subject to change without notice. No license is granted by implication or otherwise under any patent or patent rights of Analog Devices. Trademarks and registered trademarks are the property of their respective owners.

FUNCTIONAL BLOCK DIAGRAM

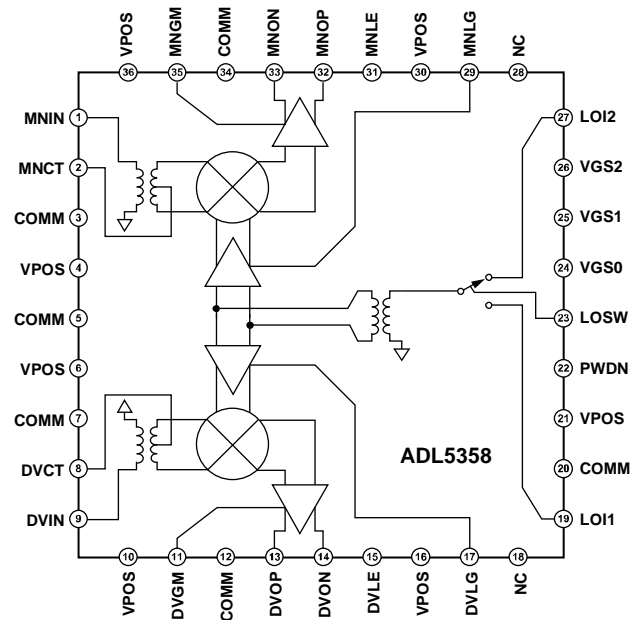

Figure 1.

The ADL5358 is fabricated using a BiCMOS high performance IC process. The device is available in a 6 mm × 6 mm, 36-lead LFCSP and operates over a -40°C to +85°C temperature range. An evaluation board is also available.

Table 1. Passive Mixers

RF Frequency (MHz)	Single Mixer	Single Mixer and IF Amp	Dual Mixer and IF Amp
500 to 1700	ADL5367	ADL5357	ADL5358
1200 to 2500	ADL5365	ADL5355	ADL5356

TABLE OF CONTENTS

Features	1	3.3 V Performance.....	15
Applications.....	1	Spurious Performance	16
General Description	1	Circuit Description.....	17
Functional Block Diagram	1	RF Subsystem	17
Revision History	2	LO Subsystem	18
Specifications.....	3	Applications Information	19
5 V Performance	4	Basic Connections.....	19
3.3 V Performance.....	4	IF Port	19
Absolute Maximum Ratings.....	5	Bias Resistor Selection	19
ESD Caution.....	5	Mixer VGS Control DAC	19
Pin Configuration and Function Descriptions.....	6	Evaluation Board	21
Typical Performance Characteristics	7	Outline Dimensions	23
5 V Performance	7	Ordering Guide	23

REVISION HISTORY

11/09—Revision 0: Initial Version

SPECIFICATIONS

$V_S = 5\text{ V}$, $I_S = 350\text{ mA}$, $T_A = 25^\circ\text{C}$, $f_{RF} = 900\text{ MHz}$, $f_{LO} = 1103\text{ MHz}$, LO power = 0 dBm, RF power = -10 dBm, $R_1 = R_4 = 1.3\text{ k}\Omega$, $R_2 = R_5 = 1\text{ k}\Omega$, $Z_o = 50\ \Omega$, $V_{GS0} = V_{GS1} = V_{GS2} = 0\text{ V}$, unless otherwise noted.

Table 2.

Parameter	Conditions	Min	Typ	Max	Unit	
RF INPUT INTERFACE						
Return Loss	Tunable to >20 dB over a limited bandwidth		20		dB	
Input Impedance			50		Ω	
RF Frequency Range		500		1700	MHz	
OUTPUT INTERFACE						
Output Impedance	Differential impedance, $f = 200\text{ MHz}$		230 0.75		Ω pF	
IF Frequency Range		30		450	MHz	
DC Bias Voltage ¹	Externally generated	3.3	5.0	5.5	V	
LO INTERFACE						
LO Power		-6	0	+10	dBm	
Return Loss			13		dB	
Input Impedance				50	Ω	
LO Frequency Range		530		1670	MHz	
POWER-DOWN (PWDN) INTERFACE ²						
PWDN Threshold	Device enabled, IF output to 90% of its final level Device disabled, supply current < 5 mA		1.0		V	
Logic 0 Level				0.4	V	
Logic 1 Level		1.4			V	
PWDN Response Time			160		ns	
PWDN Input Bias Current		Device enabled		230		ns
		Device disabled		0		μA
			70		μA	

¹ Apply supply voltage from external circuit through choke inductors.

² PWDN function is intended for use with $V_S \leq 3.6\text{ V}$ only.

ADL5358

5 V PERFORMANCE

$V_S = 5\text{ V}$, $I_S = 350\text{ mA}$, $T_A = 25^\circ\text{C}$, $f_{RF} = 900\text{ MHz}$, $f_{LO} = 1103\text{ MHz}$, LO power = 0 dBm, RF power = -10 dBm, $R_1 = R_4 = 1.3\text{ k}\Omega$, $R_2 = R_5 = 1\text{ k}\Omega$, $V_{GS0} = V_{GS1} = V_{GS2} = 0\text{ V}$, and $Z_O = 50\ \Omega$, unless otherwise noted.

Table 3.

Parameter	Conditions	Min	Typ	Max	Unit
DYNAMIC PERFORMANCE					
Power Conversion Gain	Including 4:1 IF port transformer and PCB loss	7.6	8.3	8.6	dB
Voltage Conversion Gain	$Z_{SOURCE} = 50\ \Omega$, differential $Z_{LOAD} = 200\ \Omega$ differential		14.6		dB
SSB Noise Figure			9.9		dB
SSB Noise Figure Under Blocking	5 dBm blocker present $\pm 10\text{ MHz}$ from wanted RF input, LO source filtered		23		dB
Input Third-Order Intercept (IIP3)	$f_{RF1} = 899.5\text{ MHz}$, $f_{RF2} = 900.5\text{ MHz}$, $f_{LO} = 1103\text{ MHz}$, each RF tone at -10 dBm	22	25.2		dBm
Input Second-Order Intercept (IIP2)	$f_{RF1} = 900\text{ MHz}$, $f_{RF2} = 950\text{ MHz}$, $f_{LO} = 1103\text{ MHz}$, each RF tone at -10 dBm		57		dBm
Input 1 dB Compression Point (IP1dB)			10.6		dBm
LO-to-IF Leakage	Unfiltered IF output		-33		dBm
LO-to-RF Leakage			-31		dBm
RF-to-IF Isolation			-43		dBc
IF/2 Spurious	-10 dBm input power		-72		dBc
IF/3 Spurious	-10 dBm input power		-79		dBc
IF Channel-to-Channel Isolation			54		dB
POWER SUPPLY					
Positive Supply Voltage		4.75	5	5.25	V
Quiescent Current	LO supply		170		mA
	IF supply		180		mA
Total Quiescent Current			350		mA

3.3 V PERFORMANCE

$V_S = 3.3\text{ V}$, $I_S = 200\text{ mA}$, $T_A = 25^\circ\text{C}$, $f_{RF} = 900\text{ MHz}$, $f_{LO} = 1103\text{ MHz}$, LO power = 0 dBm, RF power = -10 dBm, $R_1 = R_4 = 1.2\text{ k}\Omega$, $R_2 = R_5 = 400\ \Omega$, $V_{GS0} = V_{GS1} = V_{GS2} = 0\text{ V}$, and $Z_O = 50\ \Omega$, unless otherwise noted.

Table 4.

Parameter	Conditions	Min	Typ	Max	Unit
DYNAMIC PERFORMANCE					
Power Conversion Gain	Including 4:1 IF port transformer and PCB loss		8.3		dB
Voltage Conversion Gain	$Z_{SOURCE} = 50\ \Omega$, differential $Z_{LOAD} = 200\ \Omega$ differential		14.6		dB
SSB Noise Figure			8.9		dB
Input Third-Order Intercept (IIP3)	$f_{RF1} = 899.5\text{ MHz}$, $f_{RF2} = 900.5\text{ MHz}$, $f_{LO} = 1103\text{ MHz}$, each RF tone at -10 dBm		19.3		dBm
Input Second-Order Intercept (IIP2)	$f_{RF1} = 950\text{ MHz}$, $f_{RF2} = 900\text{ MHz}$, $f_{LO} = 1103\text{ MHz}$, each RF tone at -10 dBm		47.2		dBm
Input 1 dB Compression Point (IP1dB)			6.75		dBm
POWER INTERFACE					
Supply Voltage		3.0	3.3	3.6	V
Quiescent Current	Resistor programmable		200		mA
Total Quiescent Current	Device disabled		300		μA

ABSOLUTE MAXIMUM RATINGS

Table 5.

Parameter	Rating
Supply Voltage, V_s	5.5 V
RF Input Level	20 dBm
LO Input Level	13 dBm
MNOP, MNON, DVOP, DVON Bias	6.0 V
VGS2, VGS1, VGS0, LOSW, PWDN	5.5 V
Internal Power Dissipation	2.2 W
θ_{JA}	22°C/W
Maximum Junction Temperature	150°C
Operating Temperature Range	-40°C to +85°C
Storage Temperature Range	-65°C to +150°C
Lead Temperature (Soldering, 60 sec)	260°C

Stresses above those listed under Absolute Maximum Ratings may cause permanent damage to the device. This is a stress rating only; functional operation of the device at these or any other conditions above those indicated in the operational section of this specification is not implied. Exposure to absolute maximum rating conditions for extended periods may affect device reliability.

ESD CAUTION



ESD (electrostatic discharge) sensitive device. Charged devices and circuit boards can discharge without detection. Although this product features patented or proprietary protection circuitry, damage may occur on devices subjected to high energy ESD. Therefore, proper ESD precautions should be taken to avoid performance degradation or loss of functionality.

PIN CONFIGURATION AND FUNCTION DESCRIPTIONS

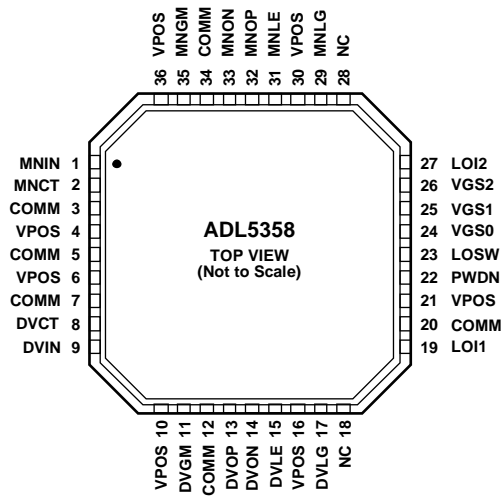

NOTES
 1. NC = NO CONNECT.
 2. EXPOSED PAD MUST BE CONNECTED TO GROUND.

07985-002

Figure 2. Pin Configuration

Table 6. Pin Function Descriptions

Pin No.	Mnemonic	Description
1	MNIN	RF Input for Main Channel. Internally matched to 50 Ω. This pin must be ac-coupled.
2	MNCT	Center Tap for Main Channel Input Balun. Bypass this pin to ground using low inductance capacitor.
3, 5, 7, 12, 20, 34	COMM	Device Common (DC Ground).
4, 6, 10, 16, 21, 30, 36	VPOS	Positive Supply Voltage.
8	DVCT	Center Tap for Diversity Channel Input Balun. Bypass to ground using low inductance capacitor.
9	DVIN	RF Input for Diversity Channel. Internally matched to 50 Ω. This pin must be ac-coupled.
11	DVGM	Diversity Amplifier Bias Setting. Connect a 1.3 kΩ resistor to ground for typical operation.
13, 14	DVOP, DVON	Diversity Channel Differential Open-Collector Outputs. DVOP and DVON should be pulled-up to VCC using external inductors.
15	DVLE	Diversity Channel IF Return. This pin must be grounded.
17	DVLG	Diversity Channel LO Buffer Bias Setting. Connect a 1 kΩ resistor to ground for typical operation.
18, 28	NC	No Connect.
19	LOI1	Local Oscillator Input 1. Internally matched to 50 Ω. This pin must be ac-coupled.
22	PWDN	Connect to Ground for Normal Operation. Connect this pin to 3 V for disable mode when using VPOS < 3.6 V. PWDN pin must be grounded when VPOS > 3.6 V.
23	LOSW	Local Oscillator Input Selection Switch. Set LOSW high to select LOI1 or set LOSW low to select LOI2.
24, 25, 26	VGS0, VGS1, VGS2	Gate to Source Control Voltages. For typical operation, set VGS0, VGS1, and VGS2 to low logic level.
27	LOI2	Local Oscillator Input 2. Internally matched to 50 Ω. This pin must be ac-coupled.
29	MNLG	Main Channel LO Buffer Bias Setting. Connect a 1 kΩ resistor to ground for typical operation.
31	MNLE	Main Channel IF Return. This pin must be grounded.
32, 33	MNOP, MNON	Main Channel Differential Open-Collector Outputs. MNOP and MNON should be pulled-up to VCC using external inductors.
35	MNGM	Main Amplifier Bias Setting. Connect a 1.3 kΩ resistor to ground for typical operation.
Paddle	EPAD	Exposed pad must be connected to ground.

TYPICAL PERFORMANCE CHARACTERISTICS

5 V PERFORMANCE

$V_s = 5\text{ V}$, $I_s = 350\text{ mA}$, $T_A = 25^\circ\text{C}$, $f_{RF} = 900\text{ MHz}$, $f_{LO} = 1103\text{ MHz}$, LO power = 0 dBm, RF power = -10 dBm, $R_1 = R_4 = 1.3\text{ k}\Omega$, $R_2 = R_5 = 1\text{ k}\Omega$, $V_{GS0} = V_{GS1} = V_{GS2} = 0\text{ V}$, $Z_o = 50\ \Omega$, unless otherwise noted.

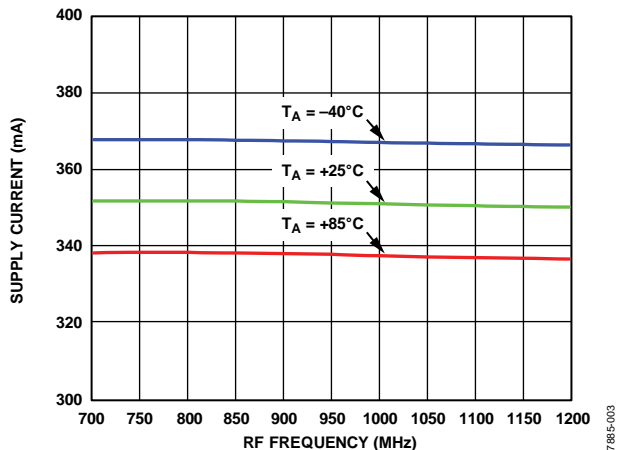

Figure 3. Supply Current vs. RF Frequency

07885-003

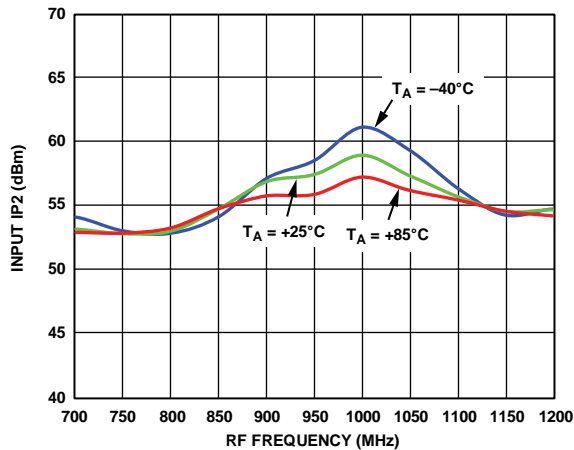

Figure 6. Input IP2 vs. RF Frequency

07885-006

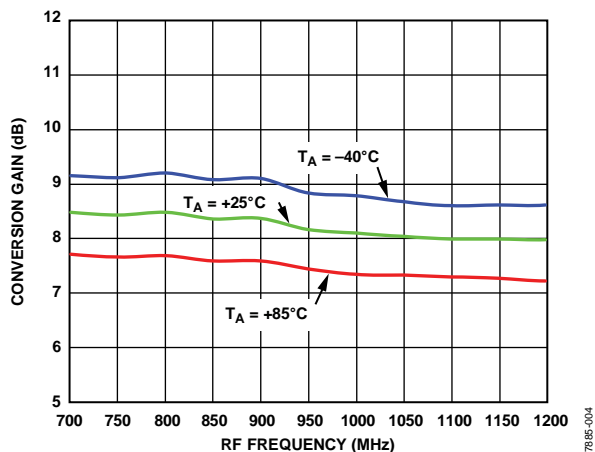

Figure 4. Power Conversion Gain vs. RF Frequency

07885-004

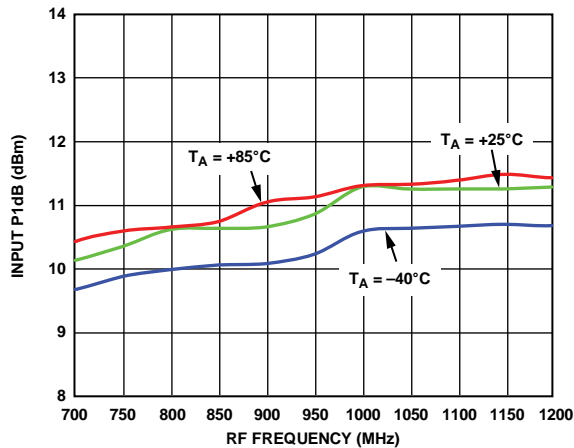

Figure 7. Input P1dB vs. RF Frequency

07885-007

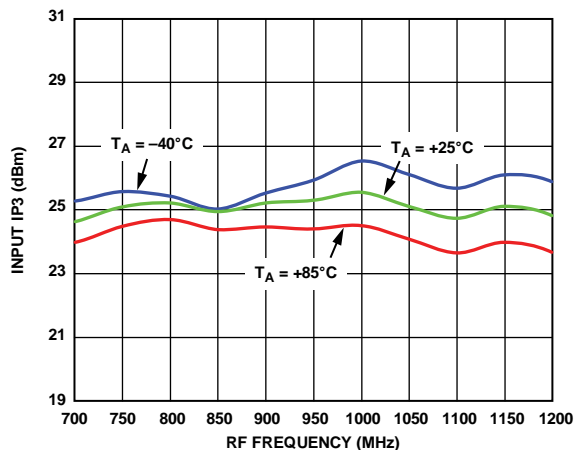

Figure 5. Input IP3 vs. RF Frequency

07885-005

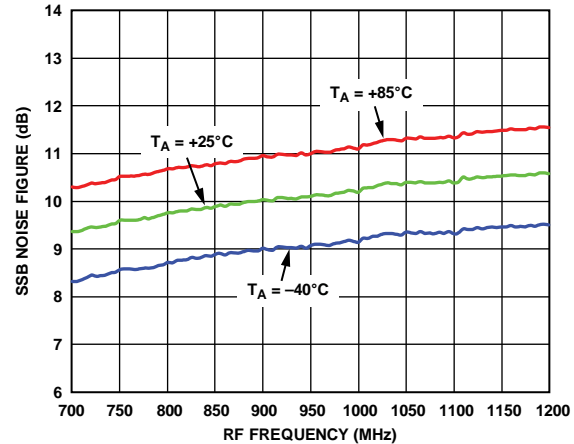

Figure 8. SSB Noise Figure vs. RF Frequency

07885-008

ADL5358

$V_S = 5\text{ V}$, $I_S = 350\text{ mA}$, $T_A = 25^\circ\text{C}$, $f_{RF} = 900\text{ MHz}$, $f_{LO} = 1103\text{ MHz}$, LO power = 0 dBm, RF power = -10 dBm, $R_1 = R_4 = 1.3\text{ k}\Omega$, $R_2 = R_5 = 1\text{ k}\Omega$, $V_{GS0} = V_{GS1} = V_{GS2} = 0\text{ V}$, $Z_O = 50\ \Omega$, unless otherwise noted.

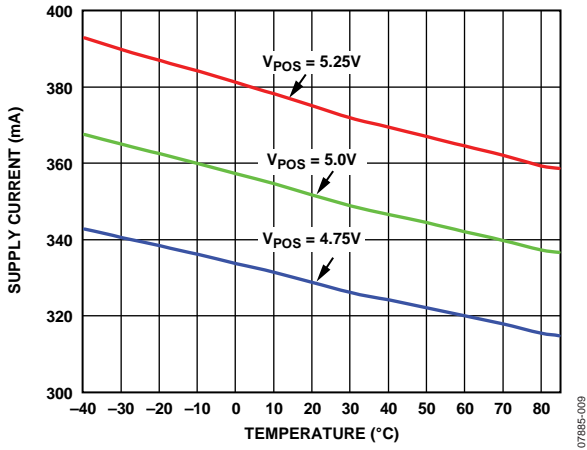

Figure 9. Supply Current vs. Temperature

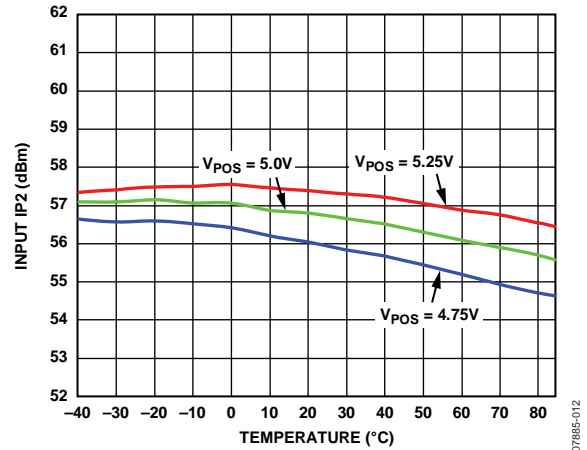

Figure 12. Input IP2 vs. Temperature

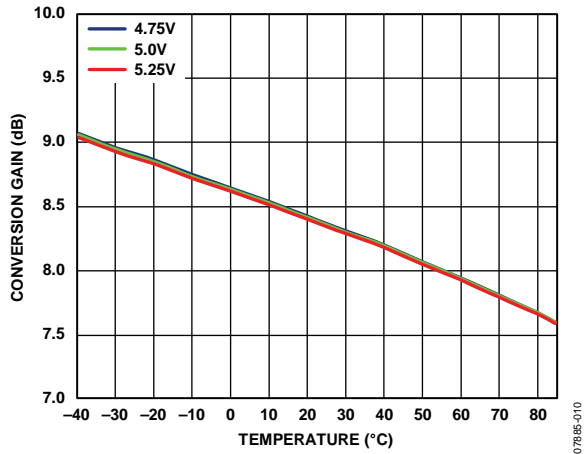

Figure 10. Power Conversion Gain vs. Temperature

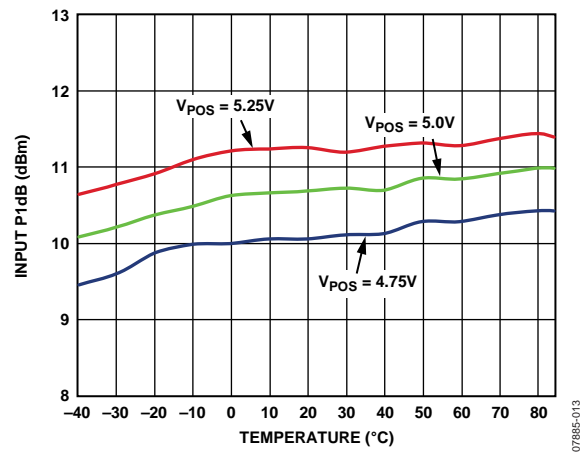

Figure 13. Input P1dB vs. Temperature

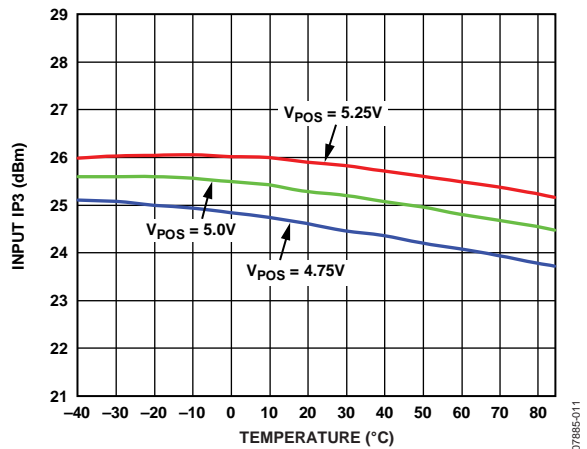

Figure 11. Input IP3 vs. Temperature

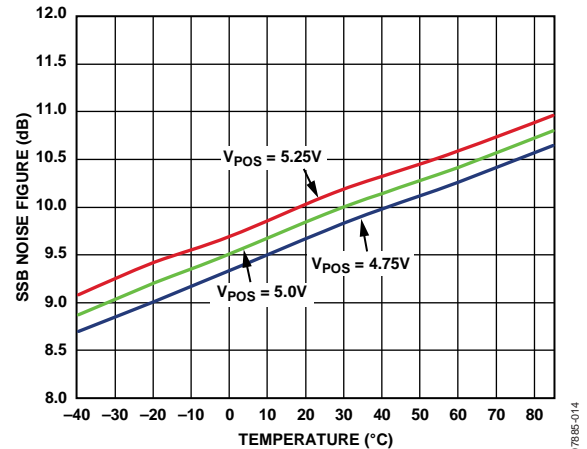

Figure 14. SSB Noise Figure vs. Temperature

$V_S = 5\text{ V}$, $I_S = 350\text{ mA}$, $T_A = 25^\circ\text{C}$, $f_{RF} = 900\text{ MHz}$, $f_{LO} = 1103\text{ MHz}$, LO power = 0 dBm, RF power = -10 dBm, $R_1 = R_4 = 1.3\text{ k}\Omega$, $R_2 = R_5 = 1\text{ k}\Omega$, $V_{GS0} = V_{GS1} = V_{GS2} = 0\text{ V}$, $Z_O = 50\ \Omega$, unless otherwise noted.

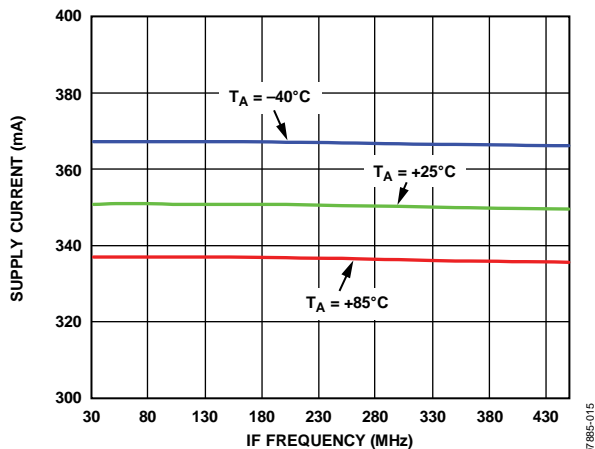

Figure 15. Supply Current vs. IF Frequency

07885-015

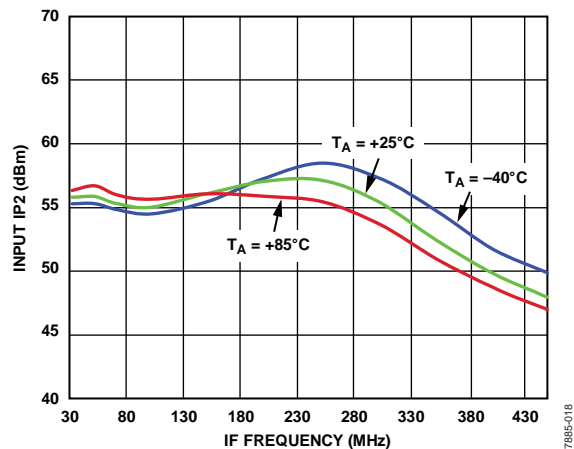

Figure 18. Input IP2 vs. IF Frequency

07885-018

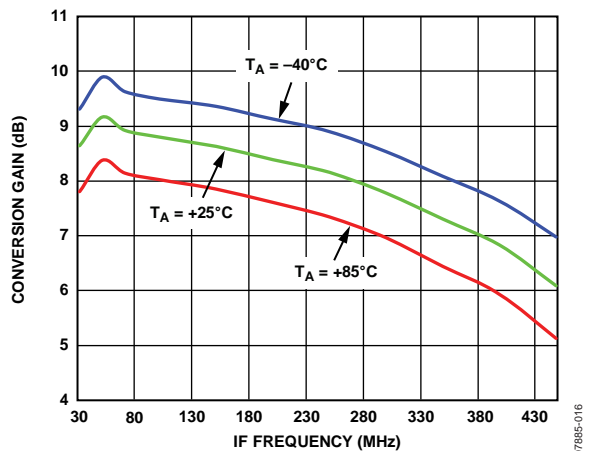

Figure 16. Power Conversion Gain vs. IF Frequency

07885-016

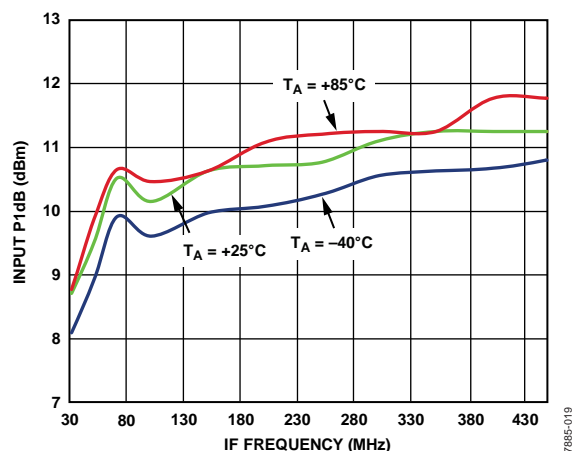

Figure 19. Input P1dB vs. IF Frequency

07885-019

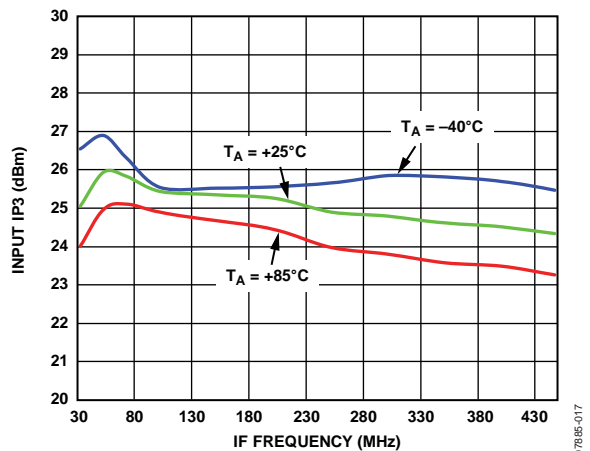

Figure 17. Input IP3 vs. IF Frequency

07885-017

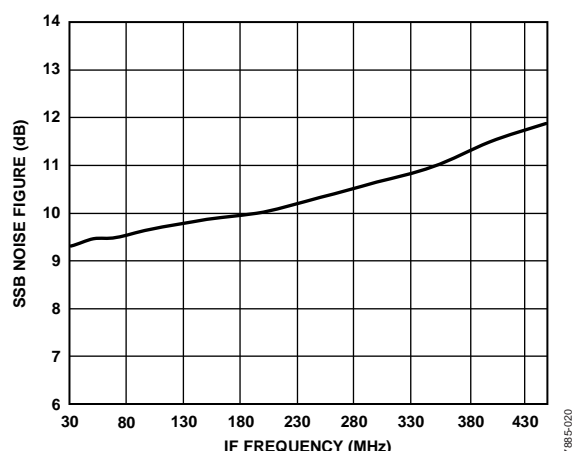

Figure 20. SSB Noise Figure vs. IF Frequency

07885-020

ADL5358

$V_S = 5\text{ V}$, $I_S = 350\text{ mA}$, $T_A = 25^\circ\text{C}$, $f_{RF} = 900\text{ MHz}$, $f_{LO} = 1103\text{ MHz}$, LO power = 0 dBm, RF power = -10 dBm, $R_1 = R_4 = 1.3\text{ k}\Omega$, $R_2 = R_5 = 1\text{ k}\Omega$, $V_{GS0} = V_{GS1} = V_{GS2} = 0\text{ V}$, $Z_0 = 50\ \Omega$, unless otherwise noted.

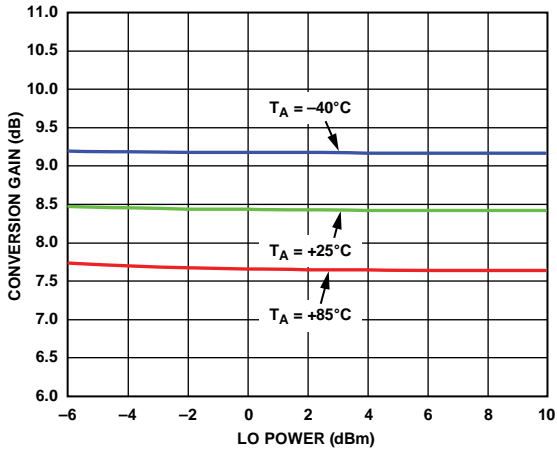

Figure 21. Power Conversion Gain vs. LO Power

07895-021

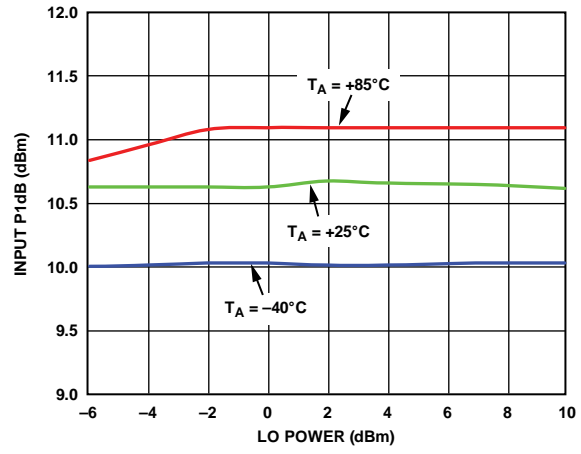

Figure 24. Input P1dB vs. LO Power

07895-024

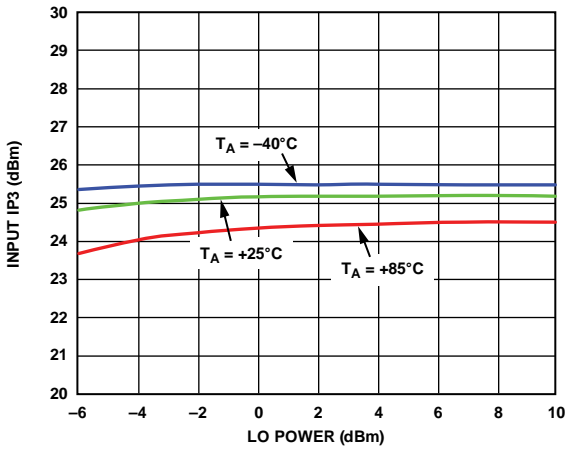

Figure 22. Input IP3 vs. LO Power

07895-022

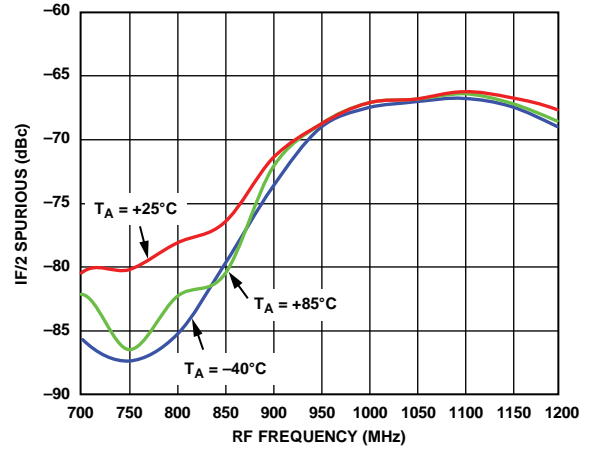

Figure 25. IF/2 Spurious vs. RF Frequency

07895-025

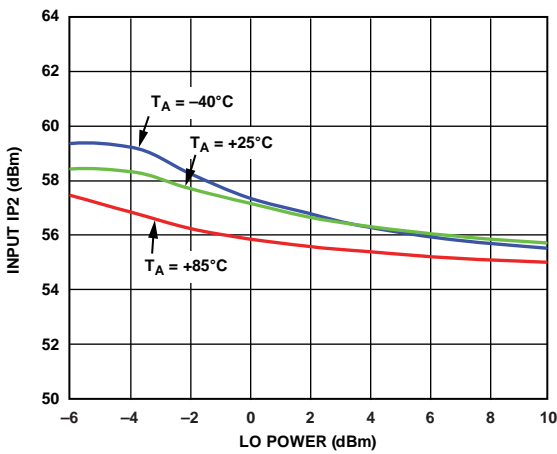

Figure 23. Input IP2 vs. LO Power

07895-023

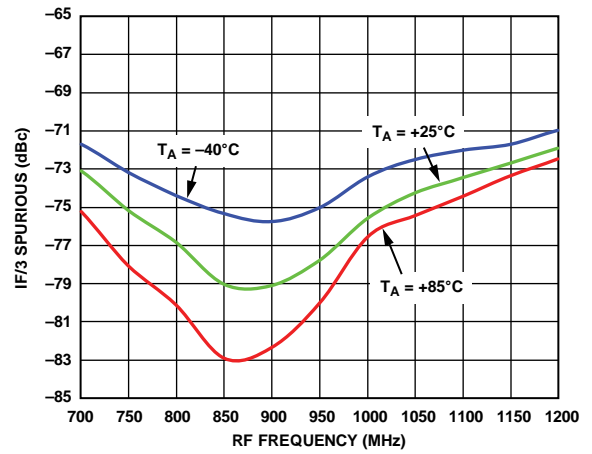

Figure 26. IF/3 Spurious vs. RF Frequency

07895-026

$V_S = 5\text{ V}$, $I_S = 350\text{ mA}$, $T_A = 25^\circ\text{C}$, $f_{RF} = 900\text{ MHz}$, $f_{LO} = 1103\text{ MHz}$, LO power = 0 dBm, RF power = -10 dBm, $R_1 = R_4 = 1.3\text{ k}\Omega$, $R_2 = R_5 = 1\text{ k}\Omega$, $Z_O = 50\ \Omega$, $V_{GS0} = V_{GS1} = V_{GS2} = 0\text{ V}$, unless otherwise noted.

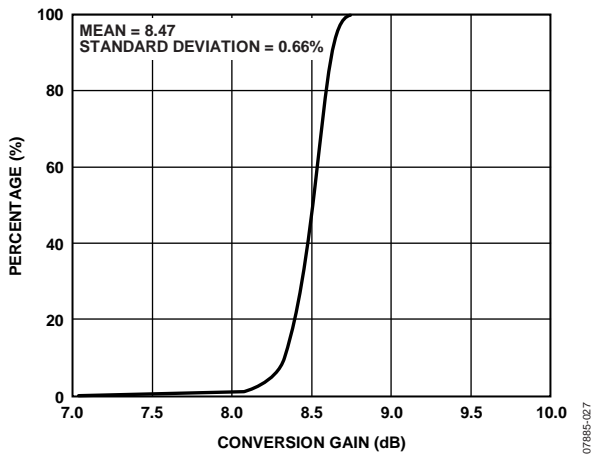

Figure 27. Conversion Gain Distribution

07885-027

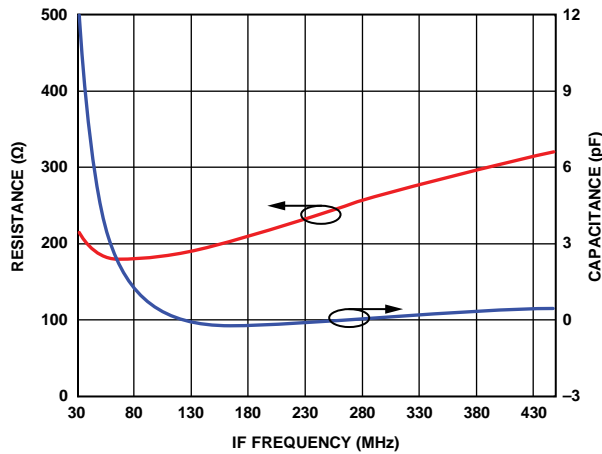

Figure 30. IF Output Impedance (R Parallel, C Equivalent)

07885-030

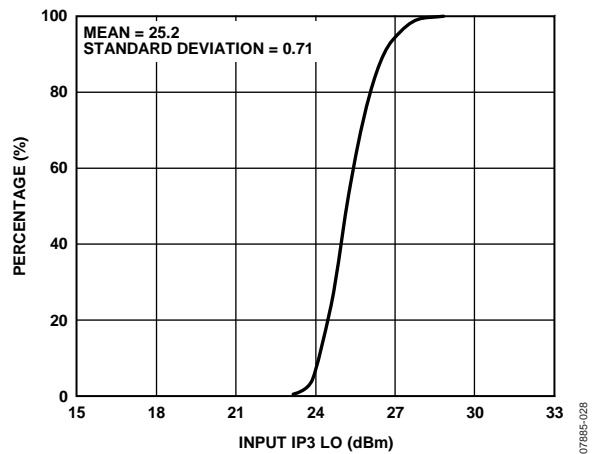

Figure 28. Input IP3 Distribution

07885-028

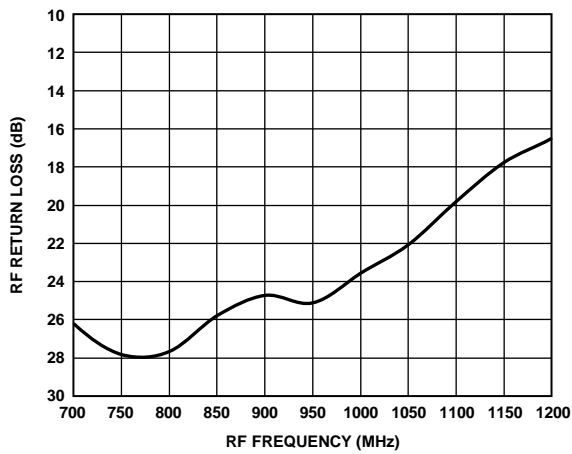

Figure 31. RF Return Loss, Fixed IF

07885-031

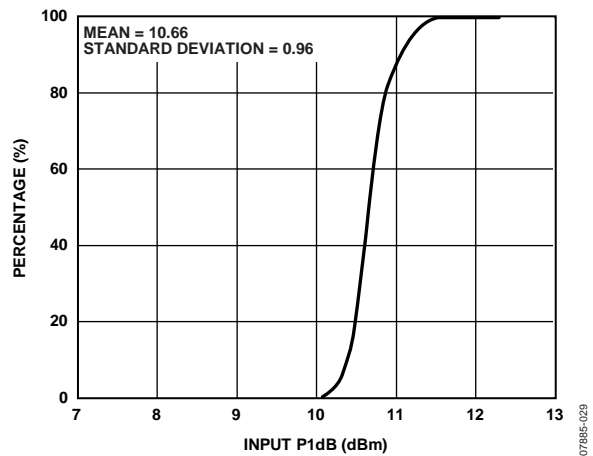

Figure 29. Input P1dB Distribution

07885-029

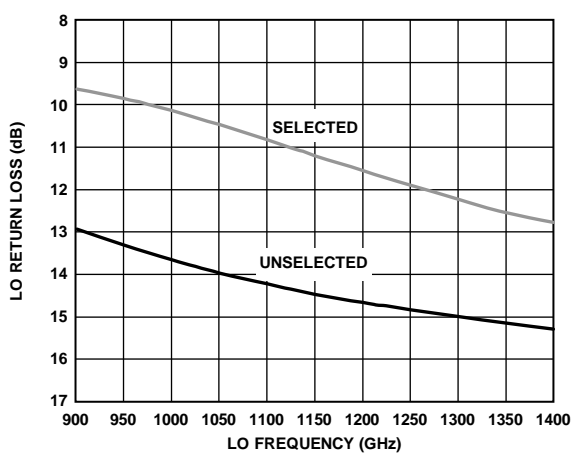

Figure 32. LO Return Loss, Selected and Unselected

07885-032

ADL5358

$V_S = 5\text{ V}$, $I_S = 350\text{ mA}$, $T_A = 25^\circ\text{C}$, $f_{RF} = 900\text{ MHz}$, $f_{LO} = 1103\text{ MHz}$, LO power = 0 dBm, RF power = -10 dBm, $R_1 = R_4 = 1.3\text{ k}\Omega$, $R_2 = R_5 = 1\text{ k}\Omega$, $Z_O = 50\ \Omega$, $V_{GS0} = V_{GS1} = V_{GS2} = 0\text{ V}$, unless otherwise noted.

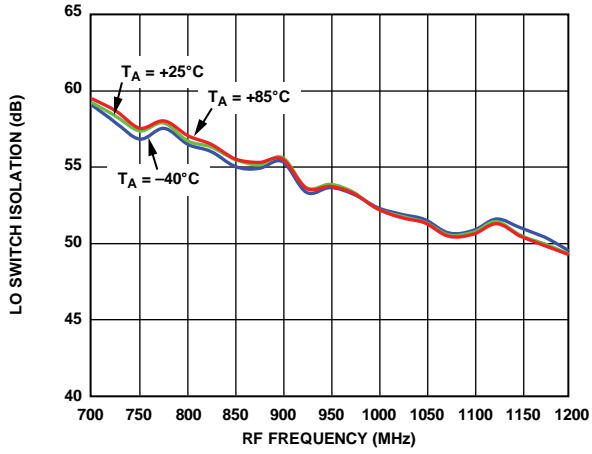

Figure 33. LO Switch Isolation vs. RF Frequency

07885-033

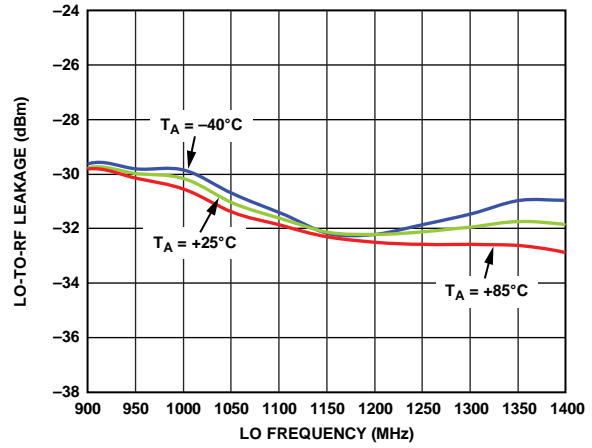

Figure 36. LO-to-RF Leakage vs. LO Frequency

07885-036

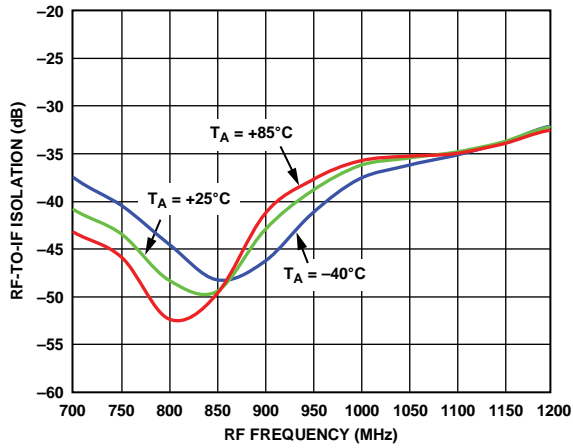

Figure 34. RF-to-IF Isolation vs. RF Frequency

07885-034

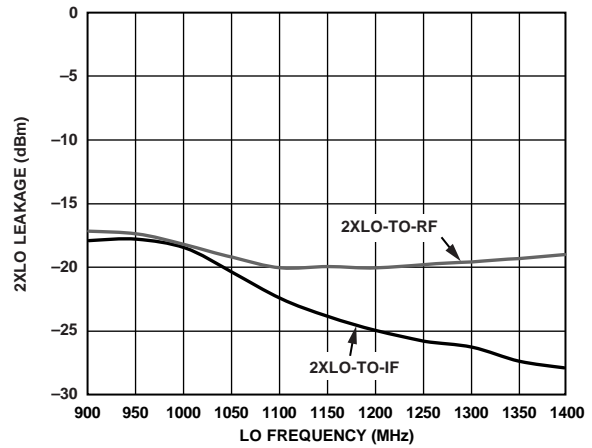

Figure 37. 2XLO Leakage vs. LO Frequency

07885-037

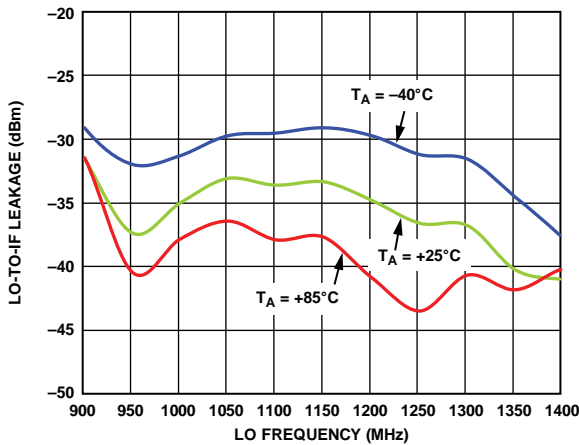

Figure 35. LO-to-IF Leakage vs. LO Frequency

07885-035

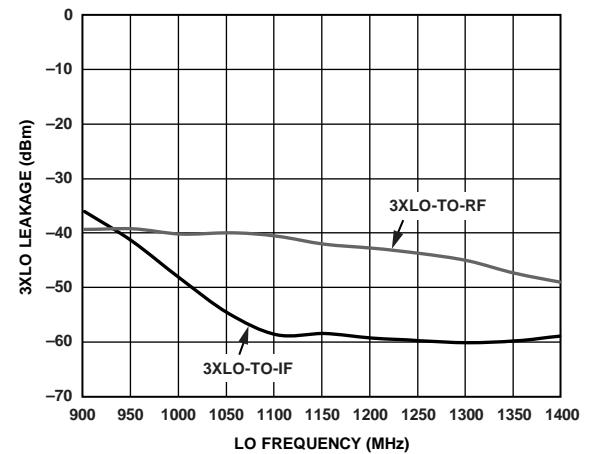

Figure 38. 3XLO Leakage vs. LO Frequency

07885-038

$V_S = 5\text{ V}$, $I_S = 350\text{ mA}$, $T_A = 25^\circ\text{C}$, $f_{RF} = 900\text{ MHz}$, $f_{LO} = 1103\text{ MHz}$, LO power = 0 dBm, RF power = -10 dBm, $R_1 = R_4 = 1.3\text{ k}\Omega$, $R_2 = R_5 = 1\text{ k}\Omega$, $V_{GS0} = V_{GS1} = V_{GS2} = 0\text{ V}$, $Z_O = 50\ \Omega$, unless otherwise noted.

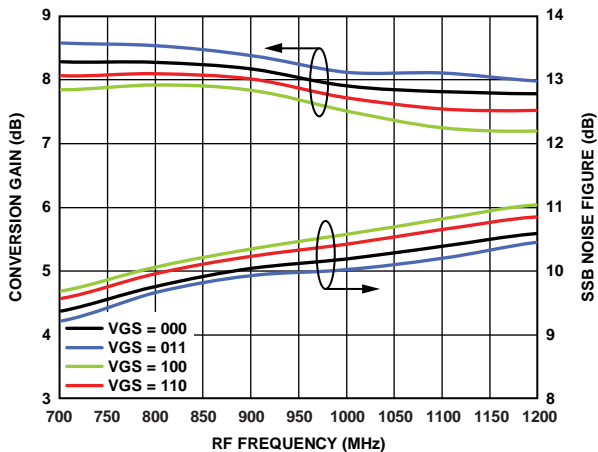

Figure 39. Power Conversion Gain and SSB Noise Figure vs. RF Frequency for Various VGS Settings

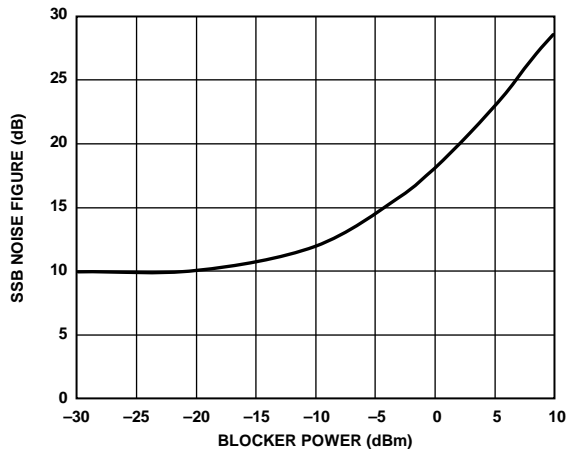

Figure 42. SSB Noise Figure vs. 10 MHz Offset Blocker Level

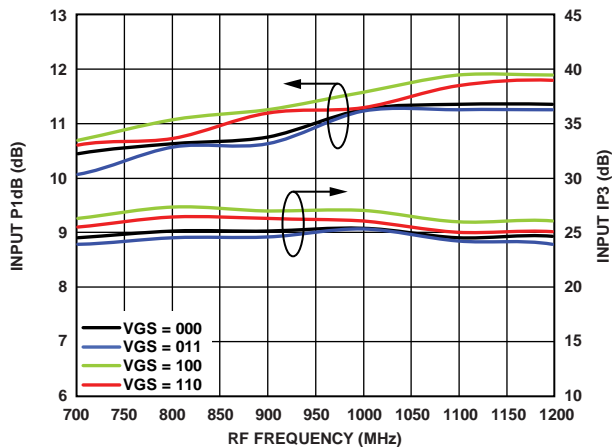

Figure 40. Input P1dB and Input IP3 vs. RF Frequency for Various VGS Settings

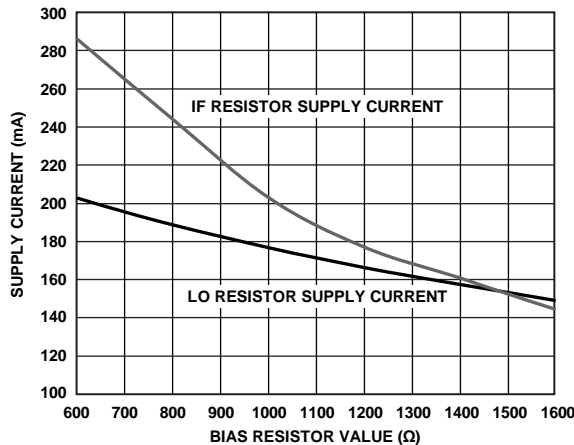

Figure 43. LO and IF Supply Current vs. IF and LO Bias Resistor Value

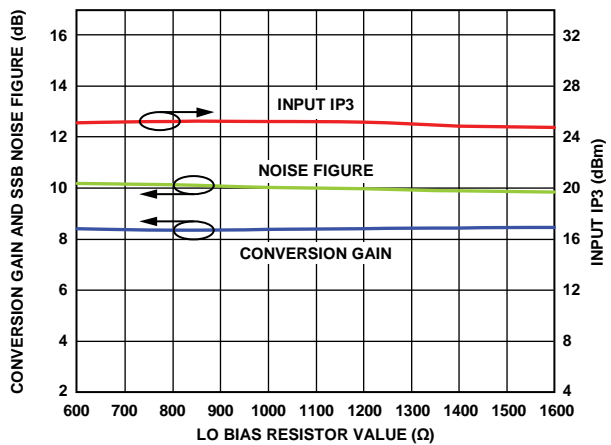

Figure 41. Power Conversion Gain, SSB Noise Figure, and Input IP3 vs. LO Bias Resistor Value

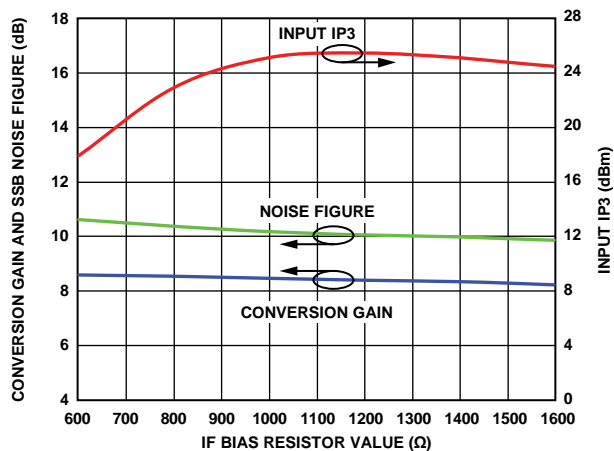

Figure 44. Power Conversion Gain, SSB Noise Figure, and Input IP3 vs. IF Bias Resistor Value

ADL5358

$V_S = 5\text{ V}$, $I_S = 350\text{ mA}$, $T_A = 25^\circ\text{C}$, $f_{RF} = 900\text{ MHz}$, $f_{LO} = 1103\text{ MHz}$, LO power = 0 dBm, RF power = -10 dBm, $R_1 = R_4 = 1.3\text{ k}\Omega$, $R_2 = R_5 = 1\text{ k}\Omega$, $V_{GS0} = V_{GS1} = V_{GS2} = 0\text{ V}$, $Z_O = 50\ \Omega$, unless otherwise noted.

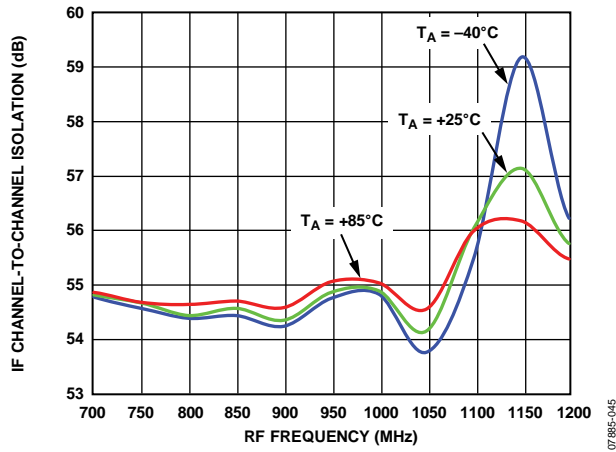

Figure 45. IF Channel-to-Channel Isolation vs. RF Frequency

07885-045

3.3 V PERFORMANCE

$V_S = 3.3\text{ V}$, $I_S = 200\text{ mA}$, $T_A = 25^\circ\text{C}$, $f_{RF} = 900\text{ MHz}$, $f_{LO} = 1103\text{ MHz}$, LO power = 0 dBm, RF power = -10 dBm, $R_1 = R_4 = 1.2\text{ k}\Omega$, $R_2 = R_5 = 400\ \Omega$, $V_{GS0} = V_{GS1} = V_{GS2} = 0\text{ V}$, $Z_O = 50\ \Omega$, unless otherwise noted.

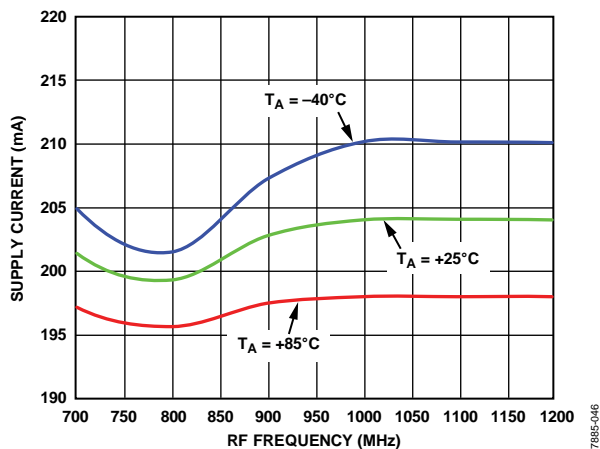

Figure 46. Supply Current vs. RF Frequency at 3.3 V

07885-046

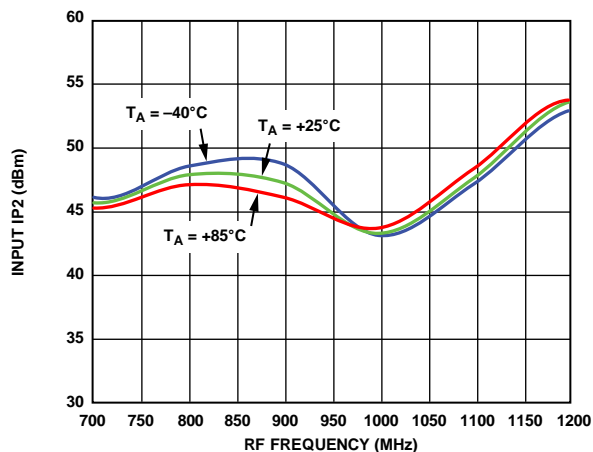

Figure 49. Input IP2 vs. RF Frequency at 3.3 V

07885-049

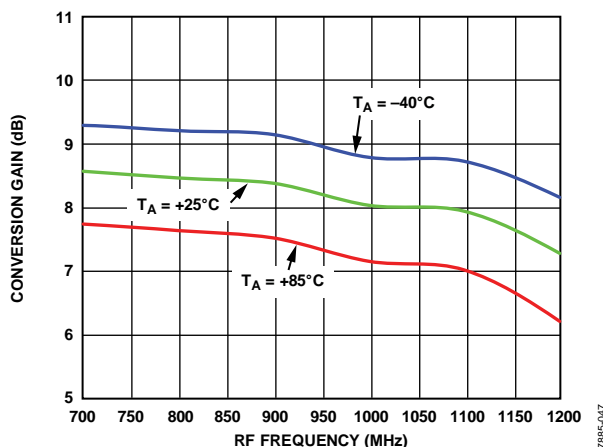

Figure 47. Power Conversion Gain vs. RF Frequency at 3.3 V

07885-047

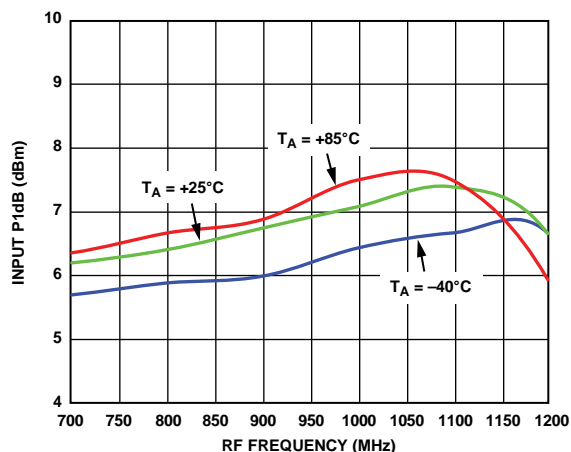

Figure 50. Input P1dB vs. RF Frequency at 3.3 V

07885-050

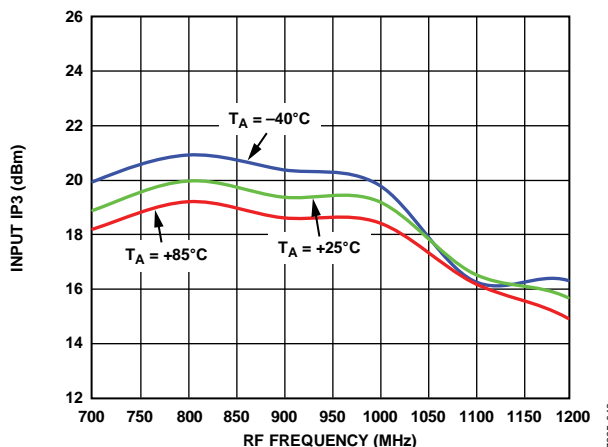

Figure 48. Input IP3 vs. RF Frequency at 3.3 V

07885-048

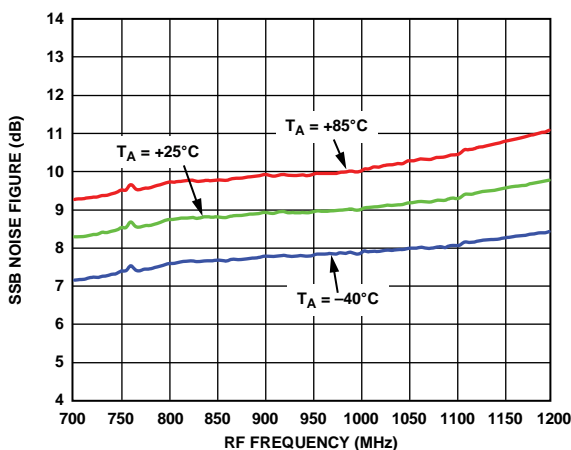

Figure 51. SSB Noise Figure vs. RF Frequency at 3.3 V

07885-051

ADL5358

SPURIOUS PERFORMANCE

All spur tables are $(N \times f_{RF}) - (M \times f_{LO})$ and were measured using the standard evaluation board. Mixer spurious products are measured in dBc from the IF output power level. Data was measured only for frequencies less than 6 GHz. Typical noise floor of the measurement system = -100 dBm.

5 V Performance

$V_S = 5\text{ V}$, $I_S = 350\text{ mA}$, $T_A = 25^\circ\text{C}$, $f_{RF} = 900\text{ MHz}$, $f_{LO} = 1103\text{ MHz}$, LO power = 0 dBm, RF power = -10 dBm, $R_1 = R_4 = 1.3\text{ k}\Omega$, $R_2 = R_5 = 1\text{ k}\Omega$, $V_{GS0} = V_{GS1} = V_{GS2} = 0\text{ V}$, and $Z_O = 50\ \Omega$, unless otherwise noted.

		M														
		0	1	2	3	4	5	6	7	8	9	10	11	12	13	14
N	0		-28.0	-21.5	-59.0	-44.2	-71.2									
	1	-52.4	0.0	-70.8	-42.4	-67.8	-65.5	-86.2								
	2	-74.8	-73.1	-78.2	-90.2	-77.6	<-100	-91.0	<-100							
	3	<-100	<-100	<-100	-91.1	<-100	<-100	<-100	<-100							
	4	<-100	<-100	<-100	<-100	<-100	<-100	<-100	<-100	<-100						
	5	<-100	<-100	<-100	<-100	<-100	<-100	<-100	<-100	<-100	<-100					
	6	<-100	<-100	<-100	<-100	<-100	<-100	<-100	<-100	<-100	<-100	<-100				
	7		<-100	<-100	<-100	<-100	<-100	<-100	<-100	<-100	<-100	<-100	<-100			
	8			<-100	<-100	<-100	<-100	<-100	<-100	<-100	<-100	<-100	<-100			
	9			<-100	<-100	<-100	<-100	<-100	<-100	<-100	<-100	<-100	<-100	<-100		
	10				<-100	<-100	<-100	<-100	<-100	<-100	<-100	<-100	<-100	<-100	<-100	
	11					<-100	<-100	<-100	<-100	<-100	<-100	<-100	<-100	<-100	<-100	<-100
	12						<-100	<-100	<-100	<-100	<-100	<-100	<-100	<-100	<-100	<-100
	13							<-100	<-100	<-100	<-100	<-100	<-100	<-100	<-100	<-100
	14								<-100	<-100	<-100	<-100	<-100	<-100	<-100	<-100

3.3 V Performance

$V_S = 3.3\text{ V}$, $I_S = 200\text{ mA}$, $T_A = 25^\circ\text{C}$, $f_{RF} = 900\text{ MHz}$, $f_{LO} = 1103\text{ MHz}$, LO power = 0 dBm, RF power = -10 dBm, $R_1 = R_4 = 1.2\text{ k}\Omega$, $R_2 = R_5 = 400\ \Omega$, $V_{GS0} = V_{GS1} = V_{GS2} = 0\text{ V}$, and $Z_O = 50\ \Omega$, unless otherwise noted.

		M														
		0	1	2	3	4	5	6	7	8	9	10	11	12	13	14
N	0		-33.3	-23.7	-49.1	-41.3	-82.9									
	1	-46.3	0.0	-64.4	-39.4	-71.2	-73.1	-86.1								
	2	-68.2	-61.5	-78.4	-81.2	-71.8	-94.6	-88.8	<-100							
	3	-99.9	-90.6	-95.2	-75.7	<-100	<-100	<-100	<-100							
	4	<-100	<-100	<-100	<-100	<-100	<-100	<-100	<-100	<-100						
	5	<-100	<-100	<-100	<-100	<-100	<-100	<-100	<-100	<-100	<-100					
	6	<-100	<-100	<-100	<-100	<-100	<-100	<-100	<-100	<-100	<-100	<-100				
	7		<-100	<-100	<-100	<-100	<-100	<-100	<-100	<-100	<-100	<-100	<-100			
	8			<-100	<-100	<-100	<-100	<-100	<-100	<-100	<-100	<-100	<-100			
	9			<-100	<-100	<-100	<-100	<-100	<-100	<-100	<-100	<-100	<-100	<-100		
	10				<-100	<-100	<-100	<-100	<-100	<-100	<-100	<-100	<-100	<-100	<-100	
	11					<-100	<-100	<-100	<-100	<-100	<-100	<-100	<-100	<-100	<-100	<-100
	12						<-100	<-100	<-100	<-100	<-100	<-100	<-100	<-100	<-100	<-100
	13							<-100	<-100	<-100	<-100	<-100	<-100	<-100	<-100	<-100
	14								<-100	<-100	<-100	<-100	<-100	<-100	<-100	<-100

CIRCUIT DESCRIPTION

The ADL5358 consists of two primary components: the radio frequency (RF) subsystem and the local oscillator (LO) subsystem. The combination of design, process, and packaging technology allows the functions of these subsystems to be integrated into a single die, using mature packaging and interconnection technologies to provide a high performance, low cost design with excellent electrical, mechanical, and thermal properties. In addition, the need for external components is minimized, optimizing cost and size.

The RF subsystem consists of integrated, low loss RF baluns, passive MOSFET mixers, sum termination networks, and IF amplifiers. The LO subsystem consists of an SPDT-terminated FET switch and two multistage limiting LO amplifiers. The purpose of the LO subsystem is to provide a large, fixed amplitude balanced signal to drive the mixer independent of the level of the LO input.

A simplified schematic of the device is shown in Figure 52.

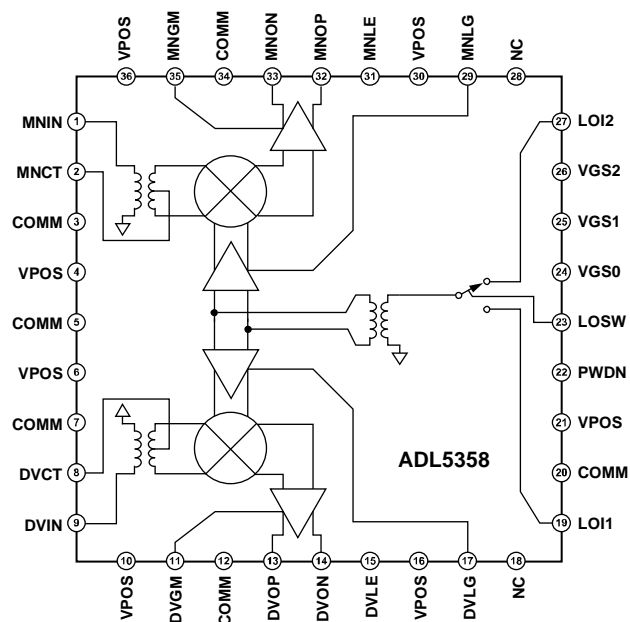

Figure 52. Simplified Schematic

RF SUBSYSTEM

The single-ended, 50 Ω RF input is internally transformed to a balanced signal using a low loss (<1 dB) unbalanced-to-balanced (balun) transformer. This transformer is made possible by an extremely low loss metal stack, which provides both excellent balance and dc isolation for the RF port. Although the port can be dc connected, it is recommended that a blocking capacitor be used to avoid running excessive dc current through the part. The RF balun can easily support an RF input frequency range of 500 MHz to 1700 MHz.

The resulting balanced RF signal is applied to a passive mixer that commutates the RF input with the output of the LO subsystem. The passive mixer is essentially a balanced, low loss switch that adds minimum noise to the frequency translation. The only noise contribution from the mixer is due to the resistive loss of the switches, which is in the order of a few ohms.

Because the mixer is inherently broadband and bidirectional, it is necessary to properly terminate all the idler ($M \times N$ product) frequencies generated by the mixing process. Terminating the mixer avoids the generation of unwanted intermodulation products and reduces the level of unwanted signals at the input of the IF amplifier, where high peak signal levels can compromise the compression and intermodulation performance of the system. This termination is accomplished by the addition of a sum network between the IF amplifier and the mixer and in the feedback elements in the IF amplifier.

The IF amplifier is a balanced feedback design that simultaneously provides the desired gain, noise figure, and input impedance that is required to achieve the overall performance. The balanced open-collector output of the IF amplifier, with impedance modified by the feedback within the amplifier, permits the output to be connected directly to a high impedance filter, differential amplifier, or an analog-to-digital input while providing optimum second-order intermodulation suppression. The differential output impedance of the IF amplifier is approximately 200 Ω . If operation in a 50 Ω system is desired, the output can be transformed to 50 Ω by using a 4:1 transformer.

The intermodulation performance of the design is generally limited by the IF amplifier. The IP3 performance can be optimized by adjusting the IF current with an external resistor. Figure 41, Figure 43, and Figure 44 illustrate how various IF and LO bias resistors affect the performance with a 5 V supply. Additionally, dc current can be saved by increasing either or both resistors. It is permissible to reduce the dc supply voltage to as low as 3.3 V, further reducing the dissipated power of the part. No performance enhancement is obtained by reducing the value of these resistors, and excessive dc power dissipation may result.

LO SUBSYSTEM

The LO amplifier is designed to provide a large signal level to the mixer to obtain optimum intermodulation performance. The resulting amplifier provides extremely high performance centered on an operating frequency of 1100 MHz. The best operation is achieved with either high-side LO injection for RF signals in the 500 MHz to 1200 MHz range or low-side injection for RF signals in the 1200 MHz to 1700 MHz range. Operation outside these ranges is permissible, and conversion gain is extremely wideband, easily spanning 500 MHz to 1700 MHz, but intermodulation is optimal over the aforementioned ranges.

The ADL5358 has two LO inputs permitting multiple synthesizers to be rapidly switched with extremely short switching times (<40 ns) for frequency agile applications. The two inputs are applied to a high isolation SPDT switch that provides a constant input impedance, regardless of whether the port is selected, to avoid pulling the LO sources. This multiple section switch also ensures high isolation to the off input, minimizing any leakage from the unwanted LO input that may result in undesired IF responses.

The single-ended LO input is converted to a fixed amplitude differential signal using a multistage, limiting LO amplifier. This results in consistent performance over a range of LO input power. Optimum performance is achieved from -6 dBm to +10 dBm, but the circuit continues to function at considerably lower levels of LO input power.

The performance of this amplifier is critical in achieving a high intercept passive mixer without degrading the noise floor of the system. This is a critical requirement in an interferer rich environment, such as cellular infrastructure, where blocking interferers can limit mixer performance. The bandwidth of the intermodulation performance is somewhat influenced by the current in the LO amplifier chain. For dc current sensitive applications, it is permissible to reduce the current in the LO amplifier by raising the value of the external bias control resistor. For dc current critical applications, the LO chain can operate with a supply voltage as low as 3.3 V, resulting in substantial dc power savings.

In addition, when operating with supply voltages below 3.6 V, the ADL5358 has a power-down mode that permits the dc current to drop to <300 μ A.

The logic inputs are designed to work with any logic family that provides a Logic 0 input level of less than 0.4 V and a Logic 1 input level that exceeds 1.4 V. All logic inputs are high impedance up to Logic 1 levels of 3.3 V. At levels exceeding 3.3 V, protection circuitry permits operation up to 5.5 V, although a small bias current is drawn.

APPLICATIONS INFORMATION

BASIC CONNECTIONS

The ADL5358 mixer is designed to downconvert radio frequencies (RF) primarily between 500 MHz and 1700 MHz to lower intermediate frequencies (IF) between 30 MHz and 450 MHz. Figure 53 depicts the basic connections of the mixer. It is recommended to ac-couple the RF and LO input ports to prevent non-zero dc voltages from damaging the RF balun or LO input circuit. The RFIN matching network consists of a series 8 pF capacitor to provide the optimized RF input return loss for the desired frequency band.

IF PORT

The mixer differential IF interface requires pull-up choke inductors to bias the open-collector outputs and to set the output match. The shunting impedance of the choke inductors used to couple dc current into the IF amplifier should be selected to provide the desired output return loss.

The real part of the output impedance is approximately 200 Ω , as seen in Figure 30, which matches many commonly used SAW filters without the need for a transformer. This results in a voltage conversion gain that is approximately 6 dB higher than the power conversion gain, as shown in Table 3. When a 50 Ω output impedance is needed, use a 4:1 impedance transformer, as shown in Figure 53.

BIAS RESISTOR SELECTION

The IF bias resistors (R1 and R4) and LO bias resistors (R2 and R5) are used to adjust the bias current of the integrated amplifiers at the IF and LO terminals. It is necessary to have a sufficient amount of current to bias both the internal IF and LO amplifiers to optimize dc current vs. optimum IIP3 performance. Figure 41, Figure 43, and Figure 44 provide the reference for the bias resistor selection when lower power consumption is preferred at the expense of conversion gain and IP3 performance.

MIXER VGS CONTROL DAC

The ADL5358 features three logic control pins, VGS0 (Pin 24), VGS1 (Pin 25), and VGS2 (Pin 26), that allow programmability for internal gate-to-source voltages for optimizing mixer performance over desired frequency bands. The evaluation board defaults VGS0, VGS1, and VGS2 to ground. Power conversion gain, NF, IIP3, and input P1dB can be optimized, as shown in Figure 39 and Figure 40.

ADL5358

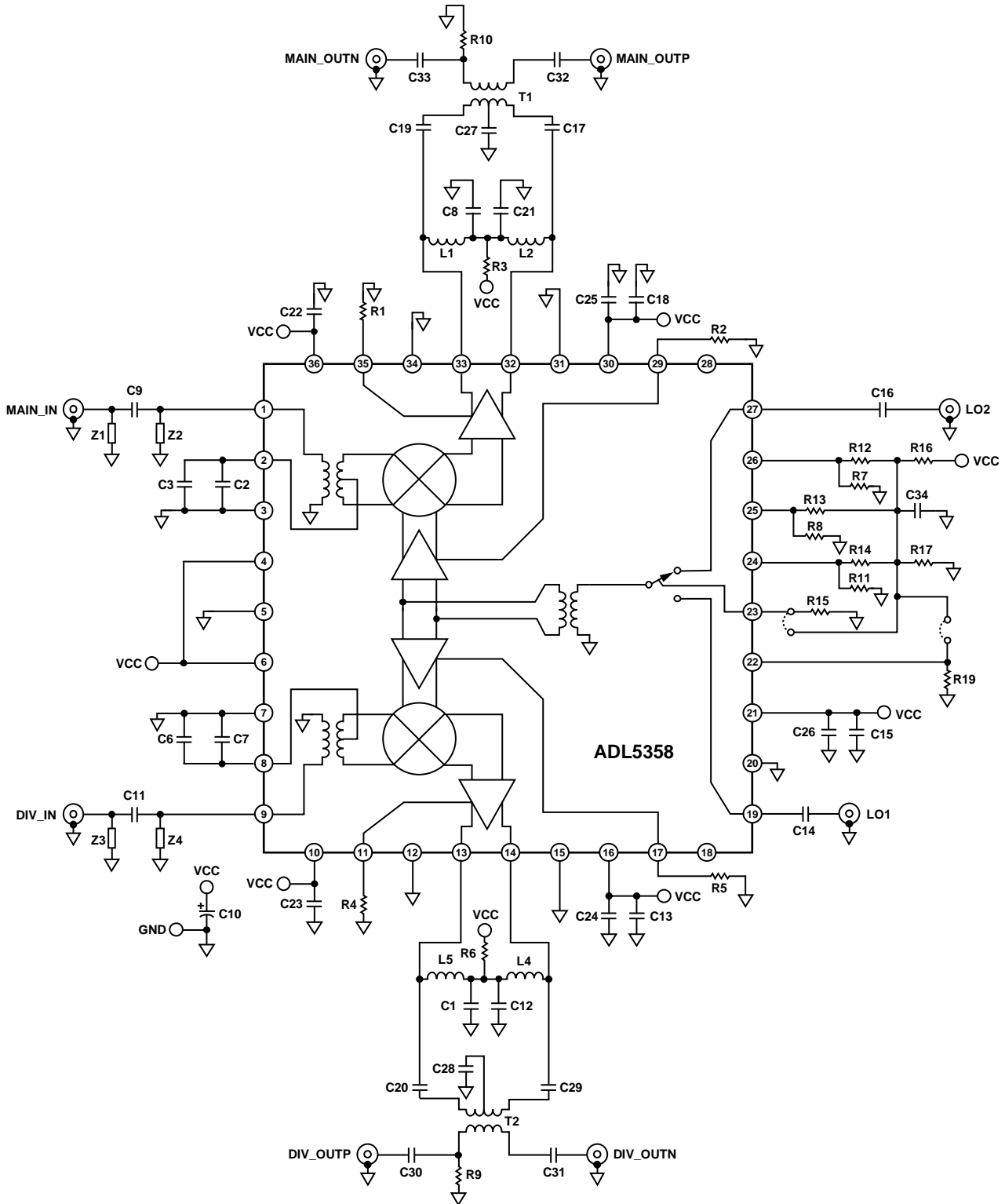

Figure 53. Typical Application Circuit

07885-153

EVALUATION BOARD

An evaluation board is available for the family of double balanced mixers. The standard evaluation board schematic is shown in Figure 54. The evaluation board is fabricated using Rogers® RO3003 material.

Table 7 describes the various configuration options of the evaluation board. Evaluation board layout is shown in Figure 55 and Figure 56.

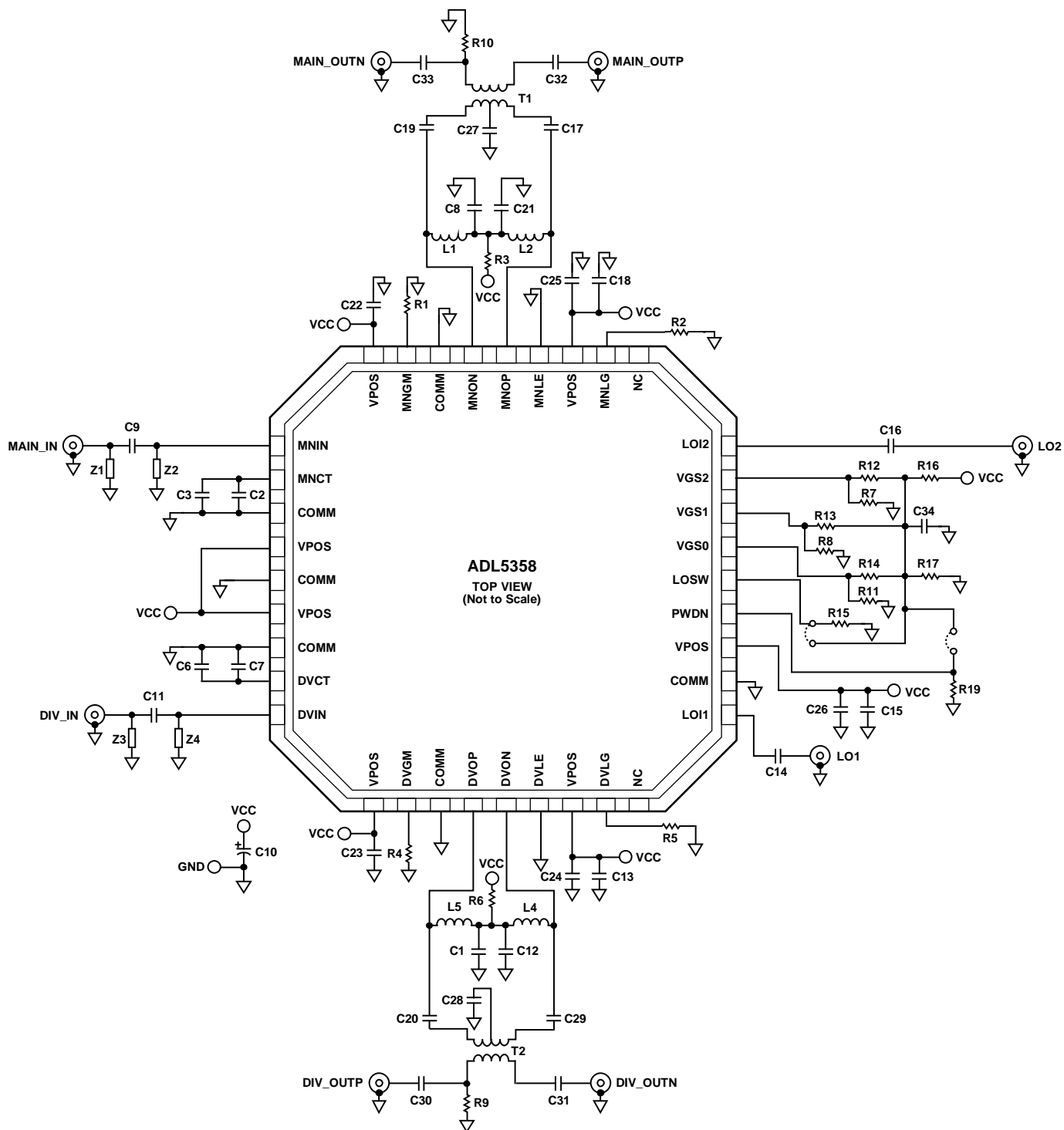

Figure 54. Evaluation Board Schematic

ADL5358

Table 7. Evaluation Board Configuration

Components	Description	Default Conditions
C1, C8, C10, C12, C13, C15, C18, C21, C22, C23, C24, C25, C26	Power Supply Decoupling. Nominal supply decoupling consists of a 0.01 μF capacitor to ground in parallel with 10 pF capacitors to ground positioned as close to the device as possible.	C1, C8, C12, C21 = 150 pF (Size 0402), C10 = 4.7 μF (Size 3216), C13, C15, C18 = 0.1 μF (Size 0402) C22, C23, C24, C25, C26 = 10 pF (Size 0402)
Z1 to Z4, C2, C3, C6, C7, C9, C11	RF Main and Diversity Input Interface. Main and diversity input channels are ac-coupled through C9 and C11. Z1 to Z4 provide additional component placement for external matching/filter networks. C2, C3, C6, and C7 provide bypassing for the center taps of the main and diversity on-chip input baluns.	Z1, Z3 = open (Size 0402), Z2, Z4 = open (Size 0402), C2, C7 = 10 pF (Size 0402), C3, C6 = 0.01 μF (Size 0402), C9, C11 = 8 pF (Size 0402)
T1, T2, C17, C19, C20, C27 to C33, L1, L2, L4, L5, R3, R6, R9, R10	IF Main and Diversity Output Interface. The open collector IF output interfaces are biased through pull-up choke inductors L1, L2, L4, and L5, with R3 and R6 available for additional supply bypassing. T1 and T2 are 4:1 impedance transformers used to provide a single-ended IF output interface with C27 and C28 providing center-tap bypassing. C17, C19, C20, C29, C30, C31, C32, and C33 ensure an ac-coupled output interface. Remove R9 and R10 for balanced output operation.	T1, T2 = TC4-1T+ (Mini-Circuits), C17, C19, C20, C29 to C33 = 0.001 μF (Size 0402), C27, C28 = 150 pF (Size 0402), L1, L2, L4, L5 = 330 nH (Size 0805), R3, R6, R9, R10 = 0 Ω (Size 0402)
C14, C16, R15, LOSW	LO Interface. C14 and C16 provide ac coupling for the LOI1 and LOI2 local oscillator inputs. LOSW selects the appropriate LO input for both mixer cores. R15 provides a pull-down to ensure LOI2 is enabled when the LOSW jumper is removed. Jumper can be removed to allow LOSW interface to be exercised using an external logic generator.	C14, C16 = 10 pF (Size 0402), R15 = 10 k Ω (Size 0402), LOSW = 2-pin shunt
R19, PWDN	PWDN Interface. When the PWDN 2-pin shunt is inserted, the ADL5358 is powered down. When R19 is open, it pulls the PWDN logic low and enables the device. Jumper can be removed to allow PWDN interface to be exercised using an external logic generator. Grounding the PWDN pin is allowed during nominal operation but is not permitted when supply voltages exceed 3.3 V.	R19 = 10 k Ω (Size 0402), PWDN = 2-pin shunt
R1, R2, R4, R5, R7, R8, R11 to R14, R16, R17, C34	Bias Control. R16 and R17 form a voltage divider to provide a 3 V for logic control, bypassed to ground through C34. R7, R8, R11, R12, R13, and R14 provide resistor programmability of VGS0, VGS1, and VGS2. Typically, these nodes can be hardwired for nominal operation. Grounding these pins is allowed for nominal operation. R2 and R5 set the bias point for the internal LO buffers. R1 and R4 set the bias point for the internal IF amplifiers.	R1, R4 = 1.3 k Ω (Size 0402), R2, R5 = 1 k Ω (Size 0402), R7, R8, R11 = 0 Ω (Size 0402), R12, R13, R14 = open (Size 0402), R16 = 10 k Ω (Size 0402), R17 = 15 k Ω (Size 0402), C34 = 1 nF (Size 0402)

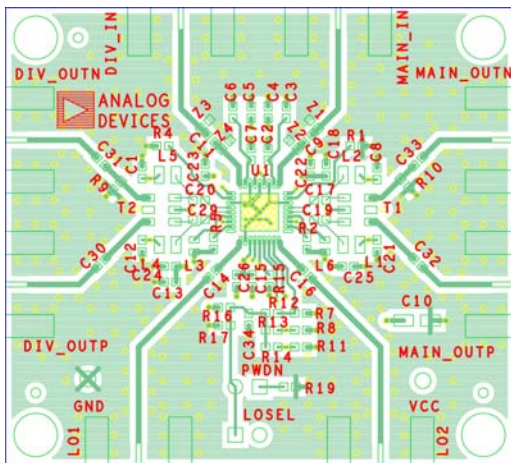
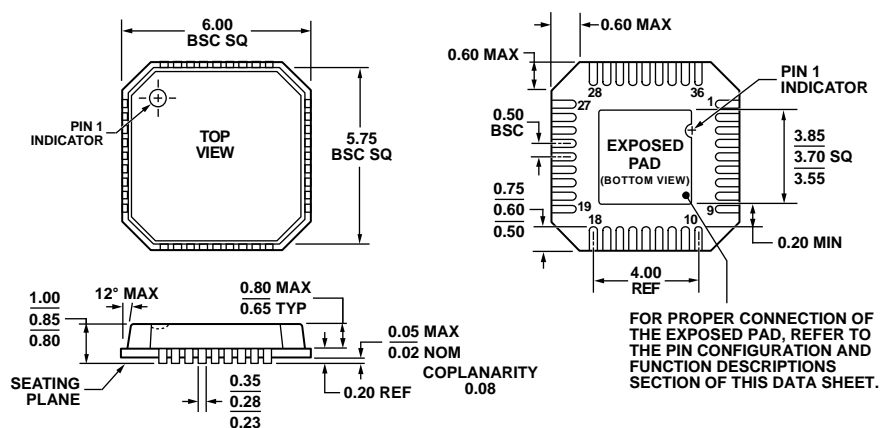

Figure 55. Evaluation Board Top Layer



Figure 56. Evaluation Board Bottom Layer

OUTLINE DIMENSIONS



COMPLIANT TO JEDEC STANDARDS MO-220-VJJD-1

Figure 57. 36-Lead Lead Frame Chip Scale Package [LFCSP_VQ]
 6mm × 6 mm Body, Very Thin Quad (CP-36-1)
 Dimensions shown in millimeters

059888-D

ORDERING GUIDE

Model	Temperature Range	Package Description	Package Option
ADL5358ACPZ-R2 ¹	-40°C to +85°C	36-Lead LFCSP_VQ	CP-36-1
ADL5358ACPZ-R7 ¹	-40°C to +85°C	36-Lead LFCSP_VQ	CP-36-1
ADL5358-EVALZ ¹		Evaluation Board	

¹ Z = RoHS Compliant Part.

ADL5358

NOTES

Looking for pricing, stock, or lifecycle information?

Click below to explore more details on WIN SOURCE:

 [View ADL5358ACPZ-R7 on WIN SOURCE](#)

 [Analog Devices Inc. Information](#)

Optimize Your Supply Chain with WIN SOURCE Solutions

-  Global Sourcing Solution
-  Obsolete Management
-  Cost Control Management
-  Shortage Management
-  Alternative Solution
-  Excess Inventory Management