



THE DATASHEET OF MD4S



**SINGLE-PHASE GLASS PASSIVATED
SILICON BRIDGE RECTIFIER**
VOLTAGE RANGE 50 to 1000 Volts CURRENT 0.8 Ampere

FEATURES

- * Surge overload rating - 35 amperes peak
- * Ideal for printed circuit board
- * Reliable low cost construction utilizing molded
- * Glass passivated device
- * Polarity symbols molded on body

MECHANICAL DATA

- * Epoxy: Device has UL flammability classification 94V-O
- * UL listed under the recognized component directory, file #E94233.
- * Mounting position: Any
- * Weight: 0.5 gram

MAXIMUM RATINGS AND ELECTRICAL CHARACTERISTICS

Ratings at 25 °C ambient temperature unless otherwise specified.
resistive or inductive load.

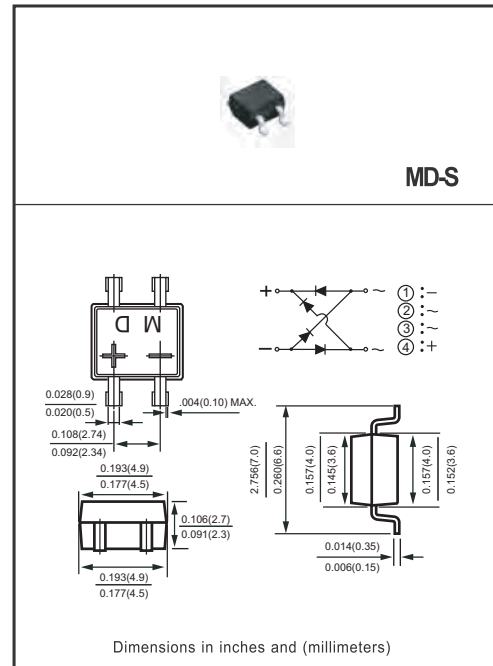

MAXIMUM RATINGS (At $T_A = 25^\circ\text{C}$ unless otherwise noted)

RATINGS	SYMBOL	MD1S	MD2S	MD3S	MD4S	MD5S	MD6S	MD7S	UNITS
Maximum Recurrent Peak Reverse Voltage	V_{RRM}	50	100	200	400	600	800	1000	Volts
Maximum RMS Bridge Input Voltage	V_{RMS}	35	70	140	280	420	560	700	Volts
Maximum DC Blocking Voltage	V_{DC}	50	100	200	400	600	800	1000	Volts
Maximum Average Forward Output Current at $T_A = 40^\circ\text{C}$	I_O	0.8							Amps
Peak Forward Surge Current 8.3 ms single half sine-wave superimposed on rated load (JEDEC method)	I_{FSM}	35							Amps
Typical Current Squared Time	I^2t	5							A^2/Sec
Typical Thermal Resistance (Note 2)	$R_{\theta JA}$	85							$^\circ\text{C}/\text{W}$
	$R_{\theta JL}$	20							
Operating and Storage Temperature Range	$T_{J,TSTG}$	-55 to + 150							$^\circ\text{C}$

ELECTRICAL CHARACTERISTICS (At $T_A = 25^\circ\text{C}$ unless otherwise noted)

CHARACTERISTICS	SYMBOL	MD1S	MD2S	MD3S	MD4S	MD5S	MD6S	MD7S	UNITS
Maximum Forward Voltage Drop per Bridge Element at 0.4 A DC	V_F	1.0							Volts
Maximum Reverse Current at Rated DC Blocking Voltage per element	@ $T_A = 25^\circ\text{C}$	1.0							μAmps
	@ $T_A = 150^\circ\text{C}$	200							μAmps

NOTES 1. "ROHS compliant"

2. Thermal Resistance: PCB mounted.

2021-12/08
REV:E

RATING AND CHARACTERISTICS CURVES (MD1S THRU MD7S)

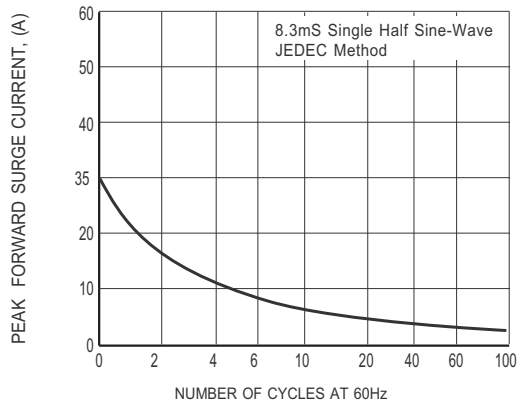

FIG. 1 - MAXIMUM NON-REPETITIVE FORWARD SURGE CURRENT

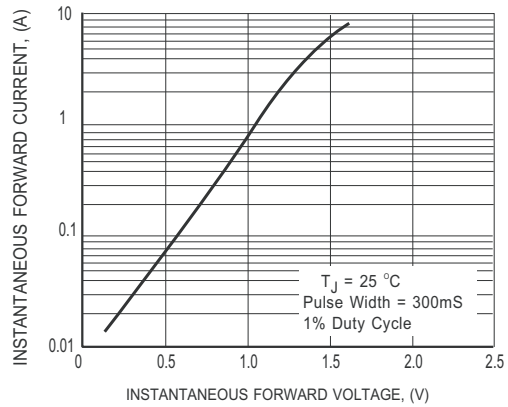

FIG. 2 MAXIMUM INSTANTANEOUS FORWARD CHARACTERISTICS

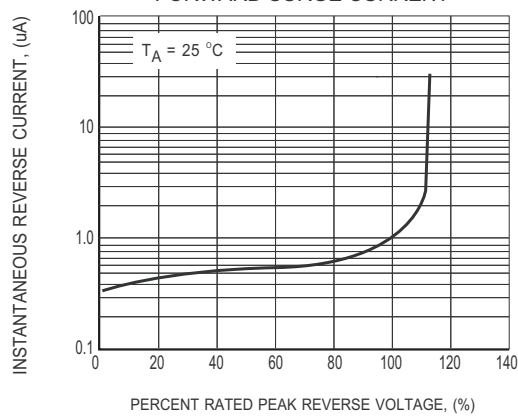

FIG. 3 MAXIMUM REVERSE CHARACTERISTICS

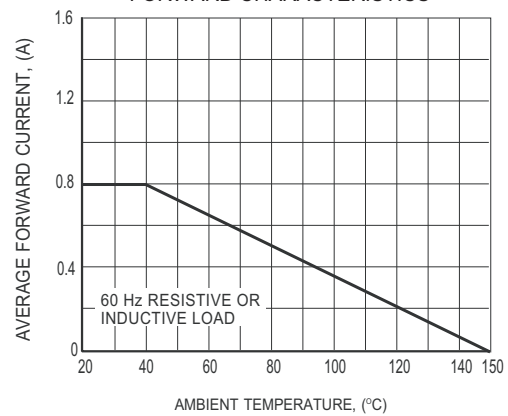
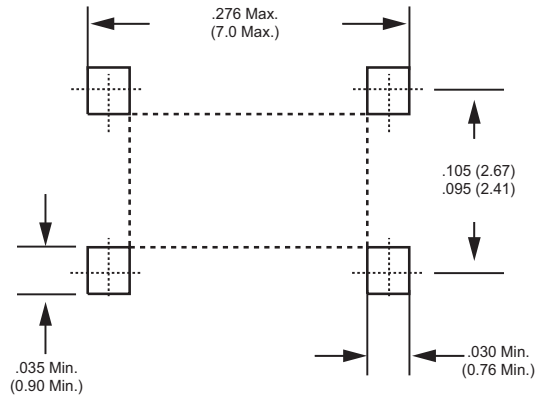

FIG. 4 TYPICAL FORWARD CURRENT DERATING CURVE

Mounting Pad Layout



Dimensions in inches and (millimeters)

REEL TAPING SPECIFICATIONS FOR SURFACE MOUNT DEVICES - MINI DIP

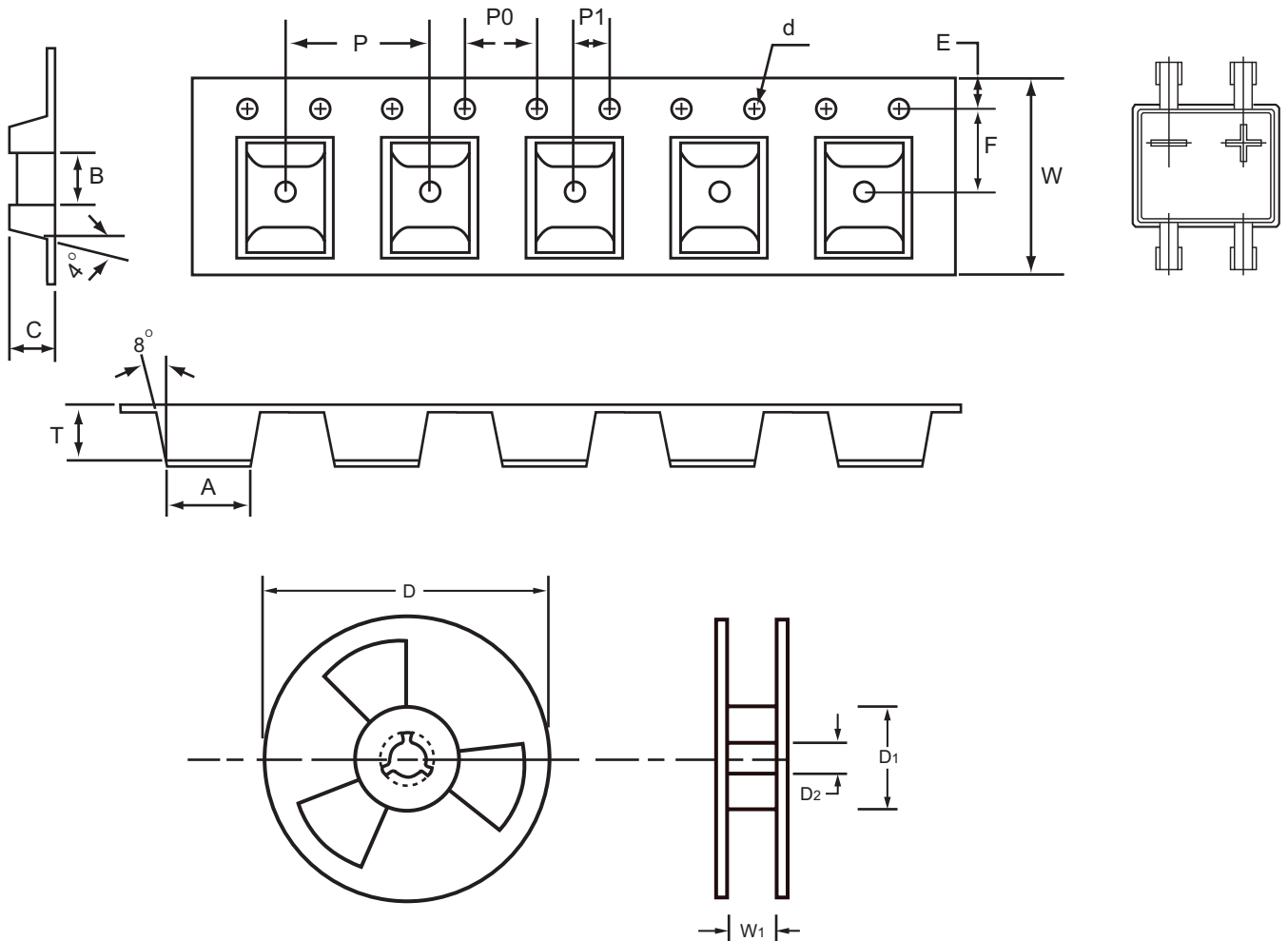

Fig.: Configuration of MINI DIP REEL TAPING

ITEM	SYMBOL	SPECIFICATIONS (mm)	SPECIFICATIONS (inch)
Carrier width	A	5.0 ± 0.1	0.197 ± 0.004
Carrier length	B	3.2 ± 0.1	0.126 ± 0.004
Carrier depth	C	2.9 ± 0.1	0.114 ± 0.004
Sprocket hole	d	1.5 ± 0.1/-0	0.059 ± 0.004
Reel outside diameter	D	178 ± 2.0	7.008 ± 0.079
Reel inner diameter	D1	8.0 ± 0.2	0.315 ± 0.008
Feed hole diameter	D2	13 ± 0.5	0.512 ± 0.020
Sprocket hole position	E	1.75 ± 0.1	0.069 ± 0.004
Punch hole position	F	5.5 ± 0.5	0.217 ± 0.020
Punch hole pitch	P	8.0 ± 0.1	0.315 ± 0.004
Sprocket hole pitch	P0	4.0 ± 0.1	0.157 ± 0.004
Embossment center	P1	2.0 ± 0.05	0.079 ± 0.002
Overall tape thickness	T	2.65 ± 0.1	0.104 ± 0.004
Tape width	W	12.0 + 0.3/-0.1	0.472 + 0.012/-0.004
Reel width	W1	16.8 ± 2.0	0.661 ± 0.079

Notes : 1.Devices are packed in accordance with EIA stand RS-481-D and specifications listed above.
2.Available on 7 inch (500 c.t.) or 13 inch (3000 c.t.) diameter reels.

PACKAGING OF DIODE AND BRIDGE RECTIFIERS

REEL PACK

PACKAGE	PACKING CODE	EA PER REEL	EA PER INNER BOX	COMPONENT SPACE (mm)	TAPE SPACE (mm)	REEL DIA (mm)	CARTON SIZE (mm)	EA PER CARTON	GROSS WEIGHT(Kg)
MD-S	-T	500	2,000	---	---	178	390*205*310	16,000	5.51
MD-S	-W	3,000	6,000	---	---	330	360*355*360	48,000	14.11



DISCLAIMER NOTICE

Rectron Inc reserves the right to make changes without notice to any product specification herein, to make corrections, modifications, enhancements or other changes. Rectron Inc or anyone on its behalf assumes no responsibility or liability for any errors or inaccuracies. Data sheet specifications and its information contained are intended to provide a product description only. "Typical" parameters which may be included on RECTRON data sheets and/ or specifications can and do vary in different applications and actual performance may vary over time. Rectron Inc does not assume any liability arising out of the application or use of any product or circuit.

Rectron products are not designed, intended or authorized for use in medical, life-saving implant or other applications intended for life-sustaining or other related applications where a failure or malfunction of component or circuitry may directly or indirectly cause injury or threaten a life without expressed written approval of Rectron Inc. Customers using or selling Rectron components for use in such applications do so at their own risk and shall agree to fully indemnify Rectron Inc and its subsidiaries harmless against all claims, damages and expenditures.

Looking for pricing, stock, or lifecycle information?

Click below to explore more details on WIN SOURCE:

-  [View MD4S on WIN SOURCE](#)
-  [Rectron USA Information](#)

Optimize Your Supply Chain with WIN SOURCE Solutions

-  Global Sourcing Solution
-  Obsolete Management
-  Cost Control Management
-  Shortage Management
-  Alternative Solution
-  Excess Inventory Management