



THE DATASHEET OF MURS205T3



MURS205T3G, SURS8205T3G, MURS210T3G, SURS8210T3G



ON Semiconductor®

www.onsemi.com

Surface Mount Ultrafast Power Rectifiers

Ideally suited for high voltage, high frequency rectification, or as free wheeling and protection diodes in surface mount applications where compact size and weight are critical to the system.

Features

- Small Compact Surface Mountable Package with J-Bend Leads
- Rectangular Package for Automated Handling
- High Temperature Glass Passivated Junction
- Low Forward Voltage Drop (0.74 V Max @ 2.0 A, $T_J = 150^\circ\text{C}$)
- SURS8 Prefix for Automotive and Other Applications Requiring Unique Site and Control Change Requirements; AEC-Q101 Qualified and PPAP Capable
- These Devices are Pb-Free, Halogen Free/REF Free and are RoHS Compliant

Mechanical Characteristics:

- Case: Epoxy, Molded
- Weight: 95 mg (Approximate)
- Finish: All External Surfaces Corrosion Resistant and Terminal Leads are Readily Solderable
- Lead and Mounting Surface Temperature for Soldering Purposes: 260°C Max for 10 Seconds
- Polarity: Polarity Band Indicates Cathode Lead
- Electrical Ratings:
 - ◆ Machine Model = C (> 400 V)
 - ◆ Human Body Model = 3A (> 4 kV)

ULTRAFAST RECTIFIERS 2 AMPERES 50-100 VOLTS



SMB
CASE 403A

MARKING DIAGRAM

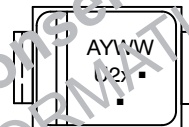

- A = Assembly Location*
- Y = Year
- WW = Work Week
- U2x = Device Code
 - x = A for MURS205T3G
 - x = B for MURS210T3G
- = Pb-Free Package

(Note: Microdot may be in either location)

* The Assembly Location Code (A) is front side optional. In cases where the Assembly Location is stamped in the package bottom (molding ejector pin), the front side assembly code may be blank.

ORDERING INFORMATION

Device	Package	Shipping†
MURS205T3G	SMB (Pb-Free)	2,500 Tape & Reel
SURS8205T3G	SMB (Pb-Free)	2,500 Tape & Reel
MURS210T3G	SMB (Pb-Free)	2,500 Tape & Reel
SURS8210T3G	SMB (Pb-Free)	2,500 Tape & Reel

†For information on tape and reel specifications, including part orientation and tape sizes, please refer to our Tape and Reel Packaging Specifications Brochure, BRD8011/D.

MURS205T3G, SURS8205T3G, MURS210T3G, SURS8210T3G

MAXIMUM RATINGS

Rating	Symbol	Value	Unit
Peak Repetitive Reverse Voltage Working Peak Reverse Voltage DC Blocking Voltage MURA205T3G, SURS8205T3G MURA210T3G, SURS8210T3G	V_{RRM} V_{RWM} V_R	50 100	V
Average Rectified Forward Current @ $T_L = 150^\circ\text{C}$ @ $T_L = 125^\circ\text{C}$	$I_{F(AV)}$	1.0 2.0	A
Non-Repetitive Peak Surge Current (Surge Applied at Rated Load Conditions Halfwave, Single Phase, 60 Hz)	I_{FSM}	50	A
Operating Junction Temperature	T_J	-60 to +175	$^\circ\text{C}$

Stresses exceeding those listed in the Maximum Ratings table may damage the device. If any of these limits are exceeded, device functionality should not be assumed, damage may occur and reliability may be affected.

THERMAL CHARACTERISTICS

Characteristic	Symbol	Max	Unit
Thermal Resistance, Junction-to-Lead ($T_L = 25^\circ\text{C}$)	$r_{\theta JL}$	13	$^\circ\text{C/W}$

ELECTRICAL CHARACTERISTICS

Characteristic	Symbol	Value	Unit
Maximum Instantaneous Forward Voltage (Note 1) ($I_F = 2.0\text{ A}$, $T_J = 25^\circ\text{C}$) ($I_F = 2.0\text{ A}$, $T_J = 150^\circ\text{C}$)	V_F	0.94 0.74	V
Maximum Instantaneous Reverse Current (Note 1) (Rated dc Voltage, $T_J = 25^\circ\text{C}$) (Rated dc Voltage, $T_J = 150^\circ\text{C}$)	I_R	2.0 50	μA
Maximum Reverse Recovery Time ($I_F = 1.0\text{ A}$, $di/dt = 50\text{ A}/\mu\text{s}$) ($I_F = 0.5\text{ A}$, $I_R = 1.0\text{ A}$, I_R to -0.25 A)	t_{rr}	30 20	ns
Maximum Forward Recovery Time ($I_F = 1.0\text{ A}$, $di/dt = 100\text{ A}/\mu\text{s}$, Reverse 1.0 V)	t_{fr}	20	ns

Product parameter performance is indicated in the Electrical Characteristics for the listed test conditions, unless otherwise noted. Product performance may not be guaranteed by the Electrical Characteristics if operated under different conditions.

1. Pulse Test: Pulse Width = 300 μs , Duty Cycle = 2.0%.

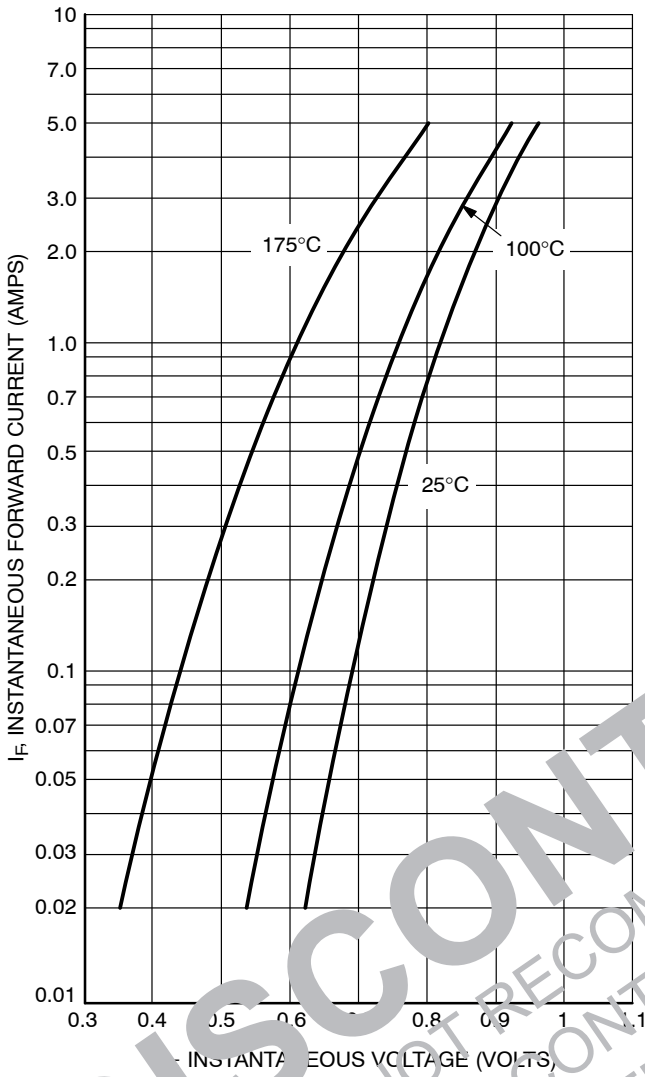

Figure 1. Typical Forward Voltage

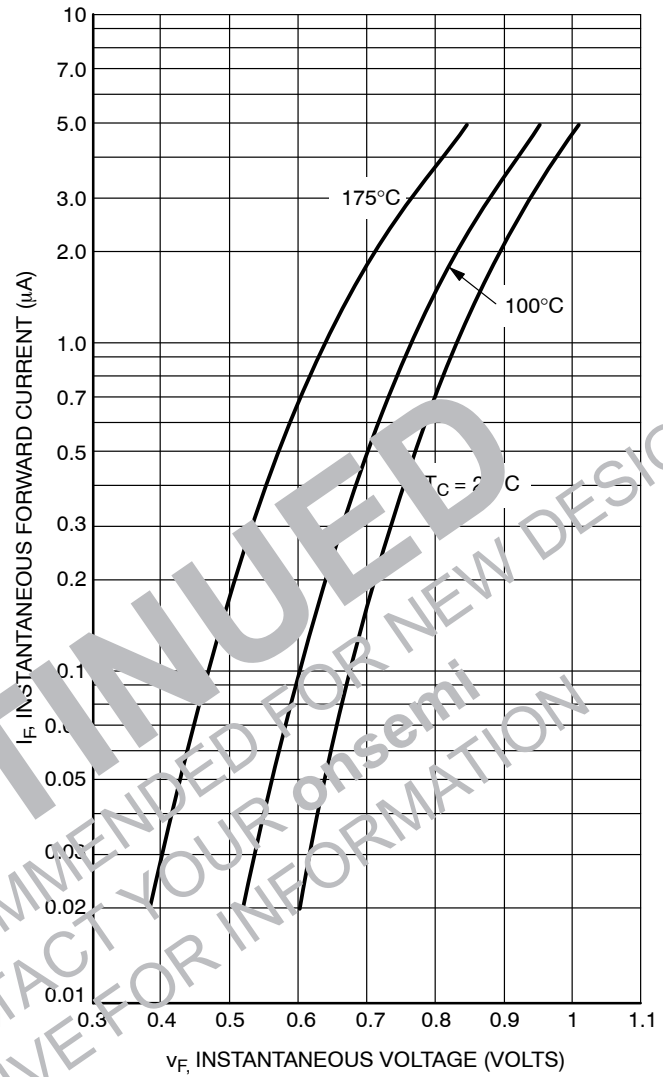

Figure 2. Maximum Forward Voltage

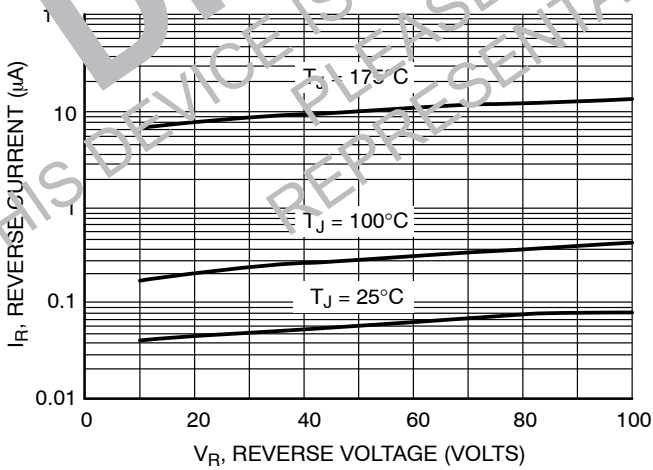

Figure 3. Typical Reverse Current*

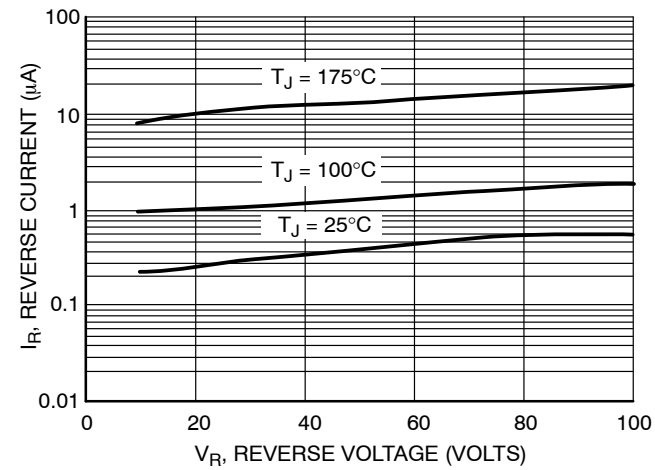

Figure 4. Maximum Reverse Current*

* The curves shown are typical for the highest voltage device in the voltage grouping. Typical reverse current for lower voltage selections can be estimated from these same curves if applied V_R is sufficiently below rated V_R .

MURS205T3G, SURS8205T3G, MURS210T3G, SURS8210T3G

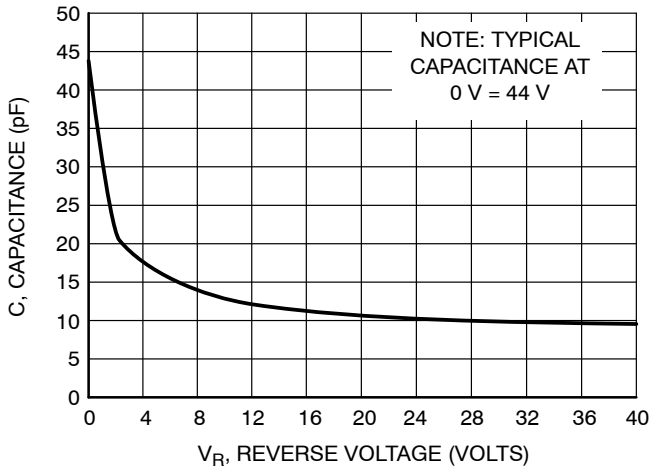

Figure 5. Typical Capacitance

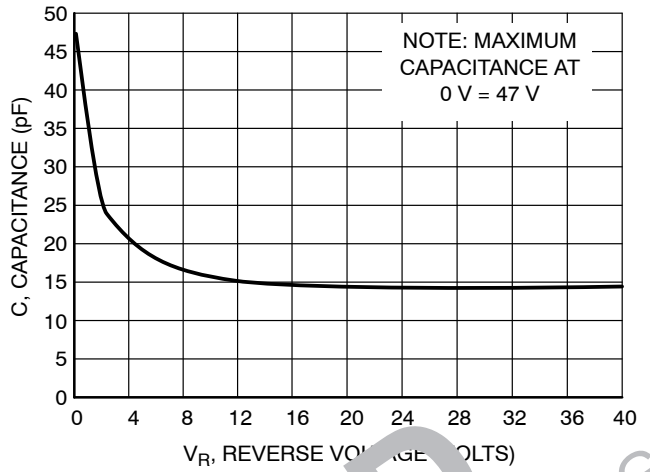

Figure 6. Maximum Capacitance

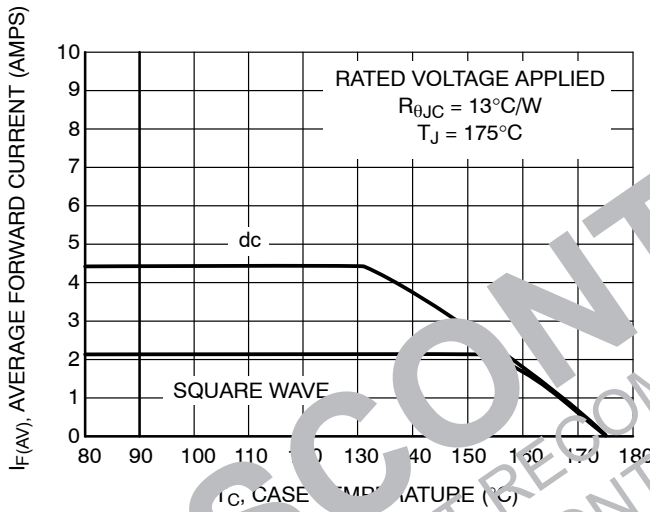

Figure 7. Current Derating, Case

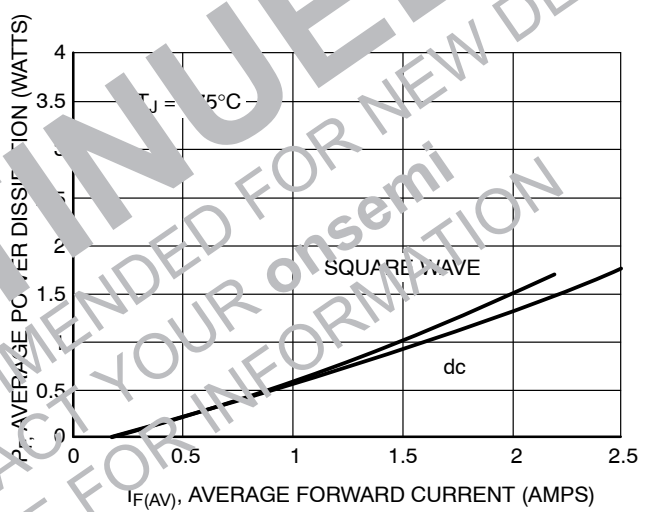

Figure 8. Power Dissipation

DISCONTINUED

THIS DEVICE IS NOT RECOMMENDED FOR NEW DESIGN

PLEASE CONTACT YOUR ONSEMI REPRESENTATIVE FOR INFORMATION

MECHANICAL CASE OUTLINE

PACKAGE DIMENSIONS

ON Semiconductor®



SCALE 1:1

Polarity Band



SCALE 1:1

Non-Polarity Band

SMB
CASE 403A-03
ISSUE J

DATE 19 JUL 2012

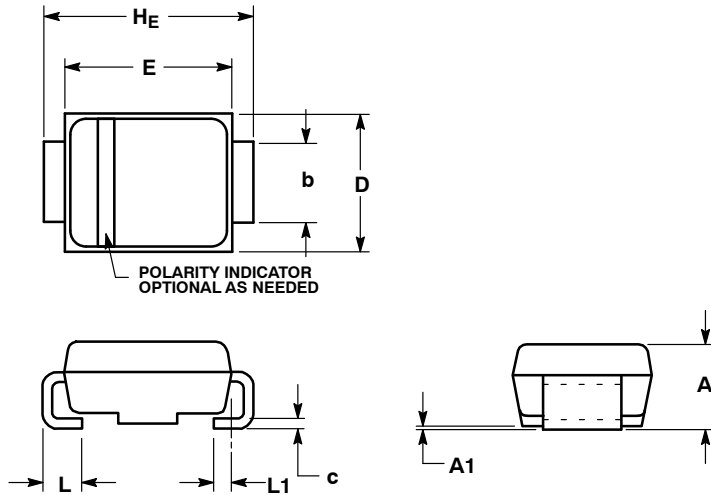

SOLDERING FOOTPRINT*

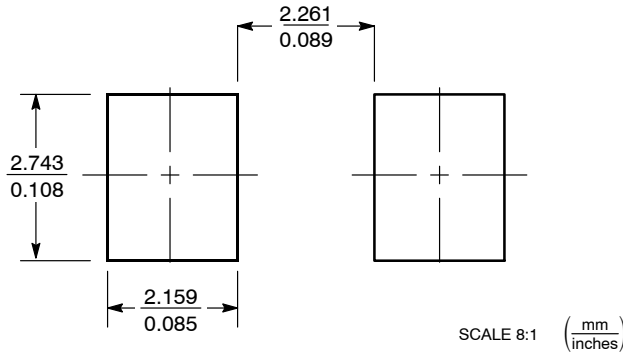

*For additional information on our Pb-Free strategy and soldering details, please download the ON Semiconductor Soldering and Mounting Techniques Reference Manual, SOLDERRM/D.

NOTES:

1. DIMENSIONING AND TOLERANCING PER ANSI Y14.5M, 1982.
2. CONTROLLING DIMENSION: INCH.
3. DIMENSION b SHALL BE MEASURED WITHIN DIMENSION L1.

DIM	MILLIMETERS			INCHES		
	MIN	NOM	MAX	MIN	NOM	MAX
A	1.95	2.30	2.47	0.077	0.091	0.097
A1	0.05	0.10	0.20	0.002	0.004	0.008
b	1.96	2.03	2.20	0.077	0.080	0.087
c	0.15	0.23	0.31	0.006	0.009	0.012
D	3.30	3.56	3.95	0.130	0.140	0.156
E	4.06	4.32	4.60	0.160	0.170	0.181
HE	5.21	5.44	5.60	0.205	0.214	0.220
L	0.76	1.02	1.60	0.030	0.040	0.063
L1	0.51 REF			0.020 REF		

GENERIC MARKING DIAGRAM*

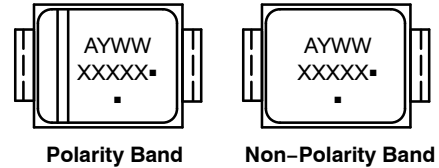

- XXXXX = Specific Device Code
 - A = Assembly Location
 - Y = Year
 - WW = Work Week
 - = Pb-Free Package
- (Note: Microdot may be in either location)

*This information is generic. Please refer to device data sheet for actual part marking. Pb-Free indicator, "G" or microdot "▪", may or may not be present.

DOCUMENT NUMBER:	98ASB42669B	Electronic versions are uncontrolled except when accessed directly from the Document Repository. Printed versions are uncontrolled except when stamped "CONTROLLED COPY" in red.
DESCRIPTION:	SMB	PAGE 1 OF 1

ON Semiconductor and are trademarks of Semiconductor Components Industries, LLC dba ON Semiconductor or its subsidiaries in the United States and/or other countries. ON Semiconductor reserves the right to make changes without further notice to any products herein. ON Semiconductor makes no warranty, representation or guarantee regarding the suitability of its products for any particular purpose, nor does ON Semiconductor assume any liability arising out of the application or use of any product or circuit, and specifically disclaims any and all liability, including without limitation special, consequential or incidental damages. ON Semiconductor does not convey any license under its patent rights nor the rights of others.

onsemi, **Onsemi**, and other names, marks, and brands are registered and/or common law trademarks of Semiconductor Components Industries, LLC dba "**onsemi**" or its affiliates and/or subsidiaries in the United States and/or other countries. **onsemi** owns the rights to a number of patents, trademarks, copyrights, trade secrets, and other intellectual property. A listing of **onsemi**'s product/patent coverage may be accessed at www.onsemi.com/site/pdf/Patent-Marking.pdf. **onsemi** reserves the right to make changes at any time to any products or information herein, without notice. The information herein is provided "as-is" and **onsemi** makes no warranty, representation or guarantee regarding the accuracy of the information, product features, availability, functionality, or suitability of its products for any particular purpose, nor does **onsemi** assume any liability arising out of the application or use of any product or circuit, and specifically disclaims any and all liability, including without limitation special, consequential or incidental damages. Buyer is responsible for its products and applications using **onsemi** products, including compliance with all laws, regulations and safety requirements or standards, regardless of any support or applications information provided by **onsemi**. "Typical" parameters which may be provided in **onsemi** data sheets and/or specifications can and do vary in different applications and actual performance may vary over time. All operating parameters, including "Typicals" must be validated for each customer application by customer's technical experts. **onsemi** does not convey any license under any of its intellectual property rights nor the rights of others. **onsemi** products are not designed, intended, or authorized for use as a critical component in life support systems or any FDA Class 3 medical devices or medical devices with a same or similar classification in a foreign jurisdiction or any devices intended for implantation in the human body. Should Buyer purchase or use **onsemi** products for any such unintended or unauthorized application, Buyer shall indemnify and hold **onsemi** and its officers, employees, subsidiaries, affiliates, and distributors harmless against all claims, costs, damages, and expenses, and reasonable attorney fees arising out of, directly or indirectly, any claim of personal injury or death associated with such unintended or unauthorized use, even if such claim alleges that **onsemi** was negligent regarding the design or manufacture of the part. **onsemi** is an Equal Opportunity/Affirmative Action Employer. This literature is subject to all applicable copyright laws and is not for resale in any manner.

ADDITIONAL INFORMATION

TECHNICAL PUBLICATIONS:

Technical Library: www.onsemi.com/design/resources/technical-documentation
onsemi Website: www.onsemi.com

ONLINE SUPPORT: www.onsemi.com/support

For additional information, please contact your local Sales Representative at www.onsemi.com/support/sales

Looking for pricing, stock, or lifecycle information?

Click below to explore more details on WIN SOURCE:

- ⊖ [View MURS205T3 on WIN SOURCE](#)
- ⊖ [ON Semiconductor Information](#)

Optimize Your Supply Chain with WIN SOURCE Solutions

- ✓ Global Sourcing Solution
- ✓ Obsolete Management
- ✓ Cost Control Management
- ✓ Shortage Management
- ✓ Alternative Solution
- ✓ Excess Inventory Management