





**THE DATASHEET OF  
BZT52C5V1S**



**SPECIFICATION SHEET**

|                                |   |
|--------------------------------|---|
| <b>SPECIFICATION SHEET NO.</b> | N0310-SOD3235V1SS0W8  |
| <b>DATE</b>                    | Mar. 10, 2021   |
| <b>REVISION</b>                | A0  |
| <b>DESCRIPTION</b>             | <p>SMD Small Signals Zener Diodes, SOD-323 series,<br/>           BZT52C5V1S Type, 2 Pads<br/>           Zener Voltage 5.1 Volts Typical, Peak Pulse Power - 200 mW<br/>           Operating Temp. Range -65°C ~+150°C<br/>           Package in Tape/Reel, 3000pcs/Reel<br/>           RoHS/RoHS III compliant</p> |
| <b>CUSTOMER</b>                |   |
| <b>CUSTOMER PART NUMBER</b>    |   |
| <b>CROSS REF. PART NUMBER</b>  |   |
| <b>ORIGINAL PART NUMBER</b>    | MDD BZT52C5V1S  |
| <b>PART CODE</b>               | SOD3235V1SS0W8  |

|                         |   |  |   |
|-------------------------|---|--|---|
| <b>VENDOR APPROVE</b>   |   |  |   |
| Issued/Checked/Approved |  |  |  |
| DATE: March 10, 2021    |   |  |   |

|                         |  |
|-------------------------|--|
| <b>CUSTOMER APPROVE</b> |  |
|                         |  |
| DATE:                   |  |

**SMD ZENER DIODES SOD-323 SERIES**



**MAIN FEATURE**

- Small Signal Zener Diodes
- SOD-323 Plastic-Encapsulate Diodes
- Total power dissipation: Max. 300mW.
- Planar die construction
- General purpose and medium current
- Wide Zener reverse voltage range 2.0V to 75V.
- Small plastic package suitable for surface mounted design.
- Tolerance approximately  $\pm 5\%$

**APPLICATION**

- For SMD application

**RFQ**

[Request For Quotation](#)

**PART CODE GUIDE**

| SOD323 | 5V1S | S | 0W8 |
|--------|------|---|-----|
| 1      | 2    | 3 | 4   |

1) **SOD323**: SMD Zener Diodes, SOD-323 series

2) **5V1S**: Type code for original part number BZT52C5V1S

3) **S**: Package code, Tape/reel, 3000pcs/reel.

4) **0W8**: Marking code for "W8" on the case surface, Different Marking for different specification.

**SMD ZENER DIODES SOD-323 SERIES**

**MORE ITEMS AVAILABLE**

|                |                |                       |                |                |
|----------------|----------------|-----------------------|----------------|----------------|
| SOD3232V0SS0WY | SOD3232V2SS0WZ | SOD3232V4SS0WX        |                |                |
| SOD3232V7SS0WX | SOD3233V0SS0W2 | SOD3233V3SS0W3        | SOD3233V6SS0W4 | SOD3233V9SS0W5 |
| SOD3234V3SS0W6 | SOD3234V7SS0W7 | <b>SOD3235V1SS0W8</b> | SOD3235V6SS0W9 |                |
| SOD3236V2SS0WA | SOD3236V8SS0WB | SOD323C7V5S0WC        | SOD3238V2SS0WD | SOD3239V1SS0WE |
| SOD323C10SS0WF | SOD323C11SS0WG | SOD323C12SS0WH        | SOD323C13SS0WI | SOD323C15SS0WJ |
| SOD323C16SS0WK | SOD323C18SS0WL | SOD323C20SS0WM        | SOD323C22SS0WN | SOD323C24SS0WO |
| SOD323C27SS0WP | SOD323C30SS0WQ | SOD323C33SS0WR        | SOD323C36SS0WS | SOD323C39SS0WT |
| SODS23C43SS0WU | SOD323C47SS0WV | SOD323C51SS0WW        | SOD323C56SS0VW |                |
| SOD323C62SS06E | SOD323C68SS06F | SOD323C75SS06H        |                |                |
|                |                |                       |                |                |

**DIMENSION (Unit: Inch/mm)**

Image for reference



Marking: W8

SOD-323

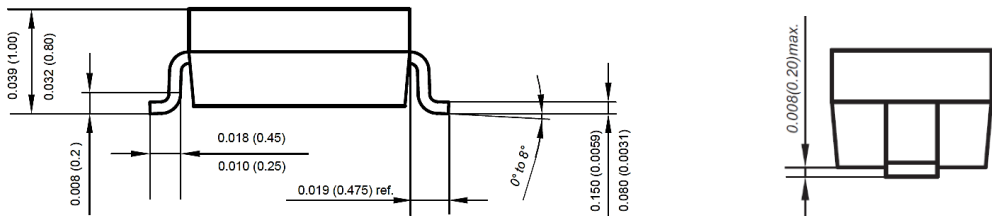
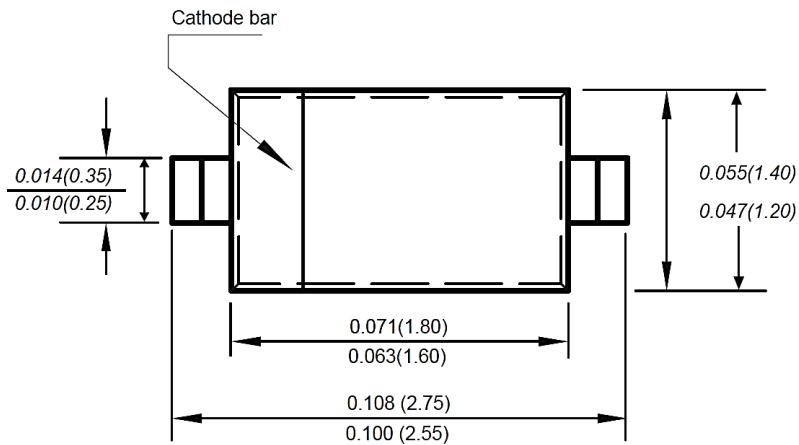

Recommend Pad Layout

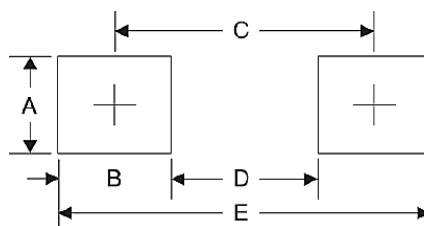

| S | Symbol | Unit (inch) | Unit (mm) |
|---|--------|-------------|-----------|
| A | A      | 0.047028    | 1.20070   |
| B | B      | 0.047028    | 1.20070   |
| C | C      | 0.126085    | 3.20115   |
| D | D      | 0.079071    | 2.00180   |
| E | E      | 0.178112    | 4.40285   |

**SMD ZENER DIODES SOD-323 SERIES**
**MECHANICAL DATA**

| Case                              | Terminals  | Polarity                        | Mounting Position | Weight per piece            |
|-----------------------------------|--|---------------------------------|-------------------|-----------------------------|
| JEDEC SOD-323 molded plastic body | Solder plated, Solderable per MIL-STD-750, Method 2026 | Polarity symbol marking on case | Any               | 0.00019 Ounce, 0.0059 grams |

**MAX. RATING & CHARACTERISTICS - Ratings at 25°C ambient temperature unless otherwise specified.**

| Parameter   | SYMBOLS          | VALUE |         |      | UNITS |
|---|------------------|-------|---------|------|-------|
|   |                  | Min.  | Typical | Max. |       |
| Forward Voltage @ IF=10mA (Note 2)                  | V <sub>F</sub>   |       | 0.9     |      | V     |
| Power Dissipation (Note 1)                          | P <sub>d</sub>   |       | 200     |      | mW    |
| Thermal resistance junction to ambient (See Note 1) | R <sub>QJA</sub> |       | 417     |      | °C/W  |
| junction temperature                                | T <sub>J</sub>   |       |         | +150 | °C    |
| Storage temperature range                           | T <sub>STG</sub> | -55   |         | +150 | °C    |

**Note**

1. Thermal resistance from junction to ambient at P.C.B. mounted with 2.0" X 2.0" (5 X 5 cm) copper areas pads.
2. Short duration test pulse used to minimize self-heating effect
3. f = 1 kHz

**ELECTRICAL CHARACTERISTICS - Ratings at 25°C ambient temperature unless otherwise specified.**

| Parameter   | SYMBOLS         | VALUE |         |      | UNITS |
|---|-----------------|-------|---------|------|-------|
|   |                 | Min.  | Typical | Max. |       |
| Zenner Voltage Range @I <sub>ZT</sub> =5.0mA (See Note 1) | V <sub>ZT</sub> | 4.8   | 5.1     | 5.4  | V     |
| Dynamic Impedance @I <sub>ZT</sub> =5.0mA                 | Z <sub>ZT</sub> |       |         | 130  | Ω     |
| Reverse Current @V <sub>R</sub> =1.5V                     | I <sub>R</sub>  |       |         | 2    | μA    |

**Note**

1. V<sub>ZT</sub> is tested with pulses (20 ms).

**SMD ZENER DIODES SOD-323 SERIES**

**RELIABILITY**

| Number | Experiment Items                   | Experiment Method And Conditions   | Reference Documents             |
|--------|------------------------------------|--|---------------------------------|
| 1      | Solder Resistance Test             | Test 260°C± 5°C for 10 ± 2 sec.<br>Immerse body into solder 1/16" ± 1/32"                                      | MIL-STD-750D<br>METHOD-2031.2   |
| 2      | Solderability Test                 | 230°C ±5°C for 5 sec.  | MIL-STD-750D<br>METHOD-2026.1 0 |
| 3      | Pull Test                          | 1 kg in axial lead direction for 10 sec.   | MIL-STD-750D<br>METHOD-2036.4   |
| 4      | Bend Test                          | 0.5Kg Weight Applied To Each Lead,<br>Bending Arcs 90 °C ± 5 °C For 3 Times                                    | MIL-STD-750D<br>METHOD-2036.4   |
| 5      | High Temperature Reverse Bias Test | TA=100°C for 1000 Hours at VR=80%<br>Rated VR  | MIL-STD-750D<br>METHOD-1038.4   |
| 6      | Forward Operation Life Test        | TA=25°C Rated Average Rectified<br>Current   | MIL-STD-750D<br>METHOD-1027.3   |
| 7      | Intermittent Operation Life Test   | On state: 5 min with rated IRMS Power<br>Off state: 5 min with Cool Forced Air.<br>On and off for 1000 cycles. | MIL-STD-750D<br>METHOD-1036.3   |
| 8      | Pressure Cooker Test               | 15 PSIG, TA=121°C, 4 hours   | MIL-S-19500<br>APPENOIXC        |
| 9      | Temperature Cycling Test           | -55°C~+125°C; 30 Minutes For Dwelled<br>Time 5 minutes for transferred time.<br>Total: 10 cycles.              | MIL-STD-750D<br>METHOD-1051.7   |
| 10     | Thermal Shock Test                 | 0°C for 5 minutes., 100°C for 5minutes,<br>Total: 10 cycles  | MIL-STD-750D<br>METHOD-1056.7   |
| 11     | Forward Surge Test                 | 8.3ms Single Sale Sine-wave One Surge.   | MIL-STD-750D<br>METHOD-4066.4   |
| 12     | Humidity Test                      | TA=65°C, RH=98% for 1000 hours.  | MIL-STD-750D<br>METHOD-1021.3   |
| 13     | High Temperature Storage life Test | 150°C for 1000 Hours   | MIL-STD-750D<br>METHOD-1031.5   |

**SUGGESTED REFLOW PROFILE (For Reference Only)**

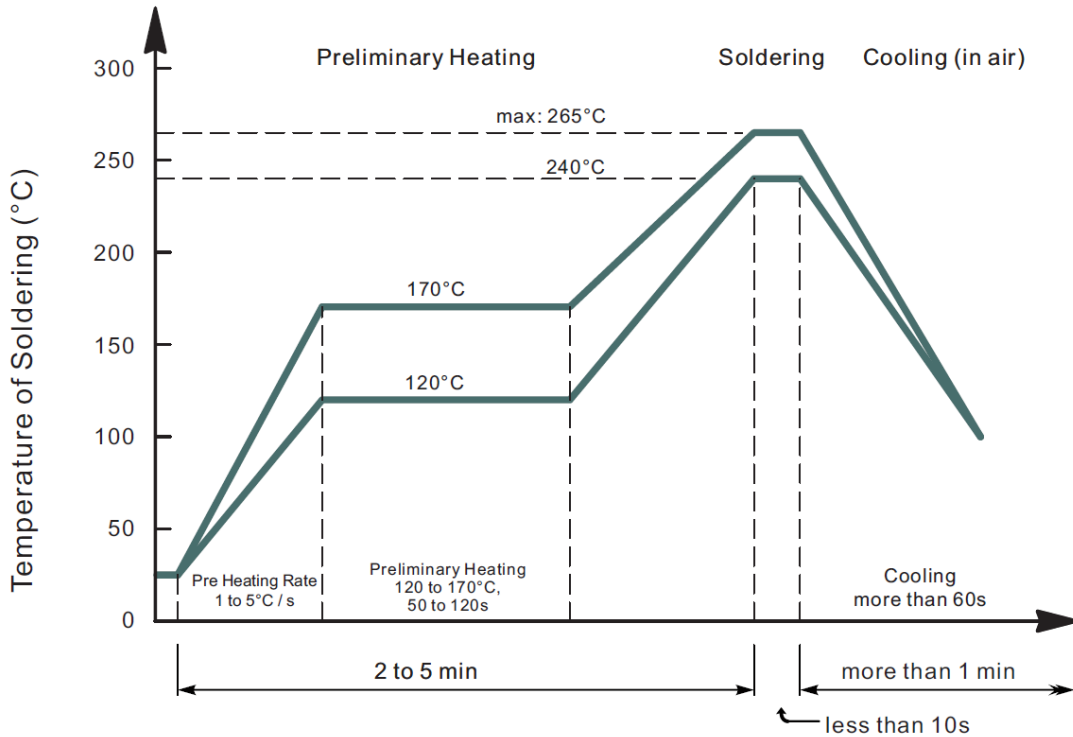

- Recommended peak temperature is over 245°C, If peak temperature is below 245 °C, you may adjust the following parameters; time length of peak temperature (longer), time length of soldering (longer), thickness of solder paste (thicker)
- Welding shall not exceed 2 times
- Remark: lead free solder paste (96.5 sn/3.0 Ag/0.5Cu)

**RATINGS AND CHARACTERISTIC CURVES (For Reference Only)**

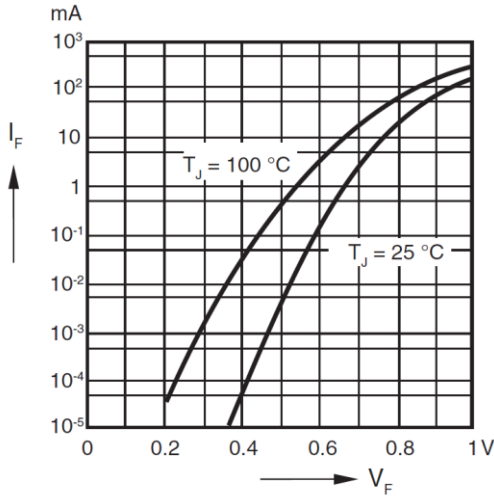

Fig. 1 - Forward characteristics

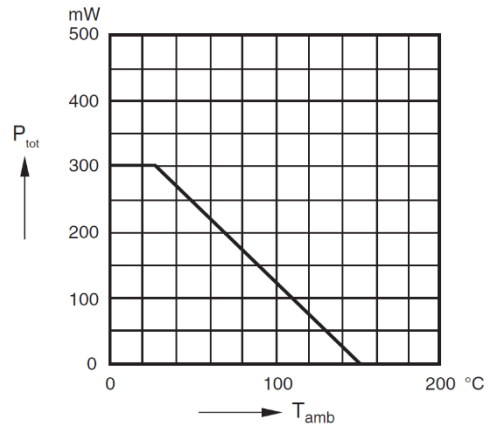

Fig. 2 - Admissible Power Dissipation vs. Ambient Temperature

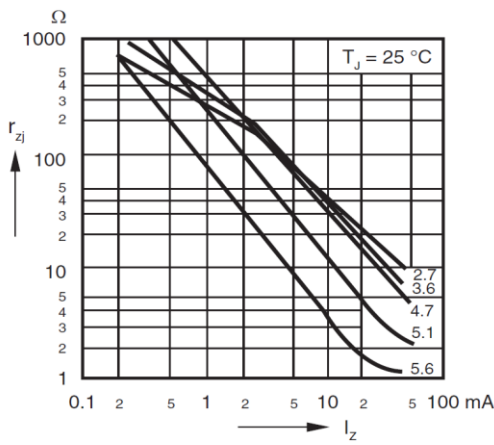

Fig. 3 - Dynamic Resistance vs. Zener Current

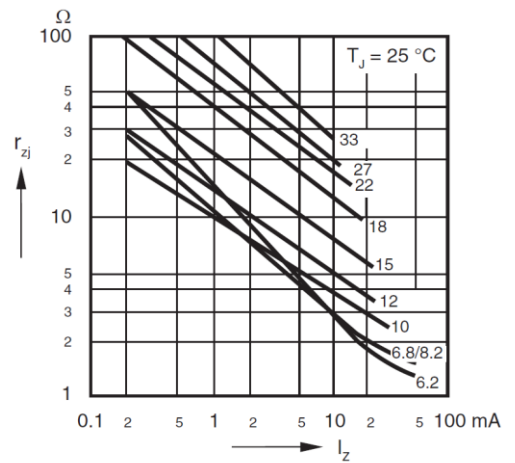

Fig. 4 - Dynamic Resistance vs. Zener Current

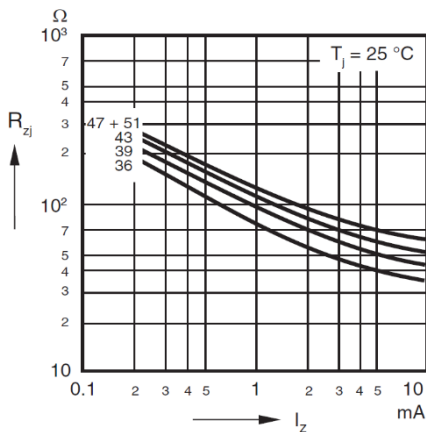

Fig. 5 - Dynamic Resistance vs. Zener Current

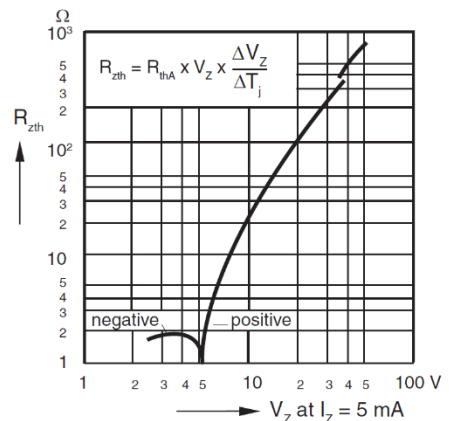

Fig. 6 - Thermal Differential Resistance vs. Zener Voltage

**RATINGS AND CHARACTERISTIC CURVES (For Reference Only)**

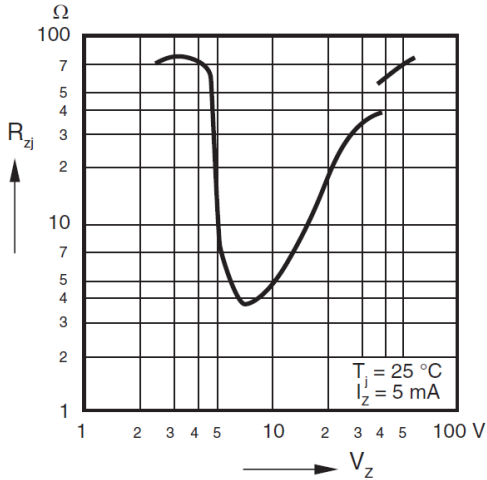

Fig. 7 - Dynamic Resistance vs. Zener Voltage

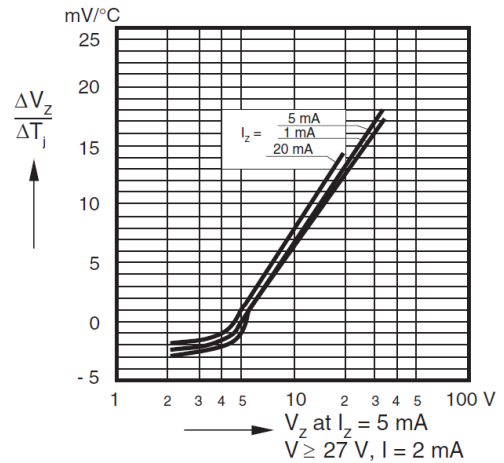

Fig. 8 - Temperature Dependence of Zener Voltage vs. Zener Voltage

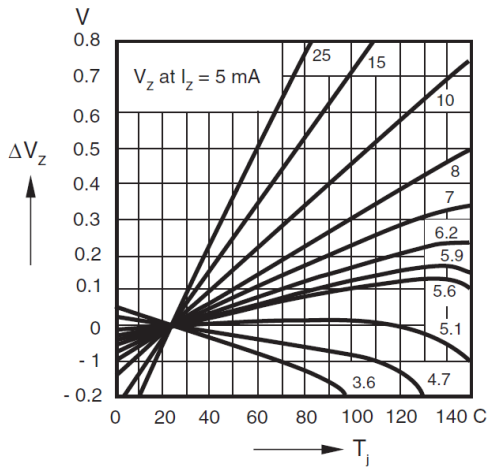

Fig. 9 - Change of Zener Voltage vs. Junction Temperature

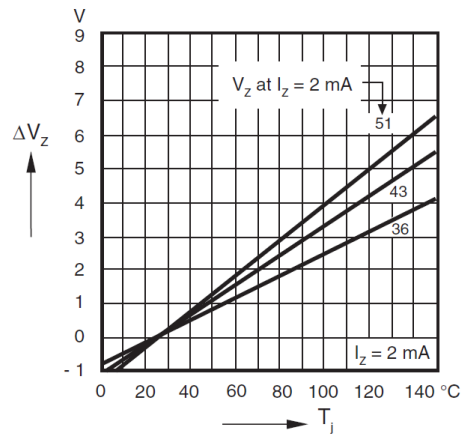

Fig. 10 - Change of Zener Voltage vs. Junction Temperature

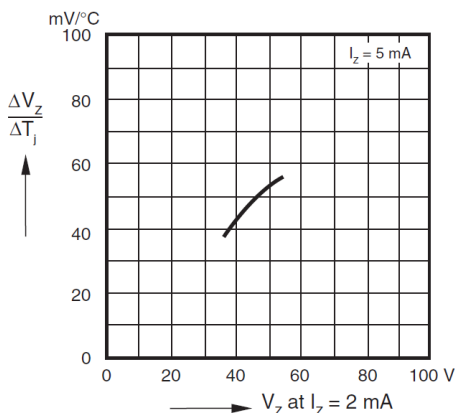

Fig. 11 - Temperature Dependence of Zener Voltage vs. Zener Voltage

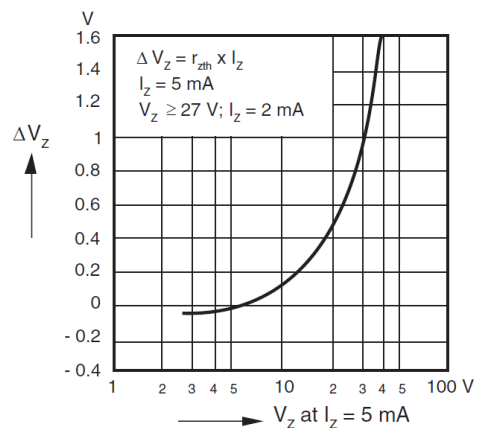

Fig. 12 - Change of Zener Voltage from Turn-on up to the Point of Thermal Equilibrium vs. Zener Voltage

**RATINGS AND CHARACTERISTIC CURVES (For Reference Only)**

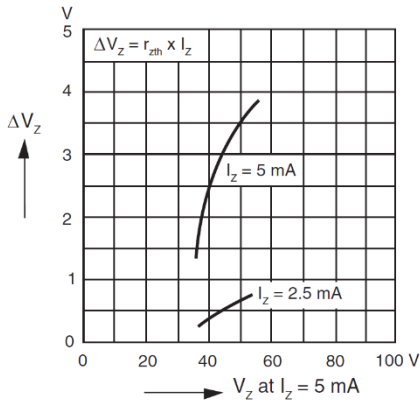

Fig. 13 - Change of Zener Voltage from Turn-on up to the Point of Thermal Equilibrium vs. Zener Voltage

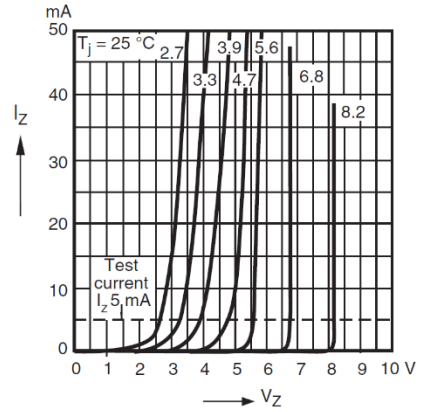

Fig. 14 - Breakdown Characteristics

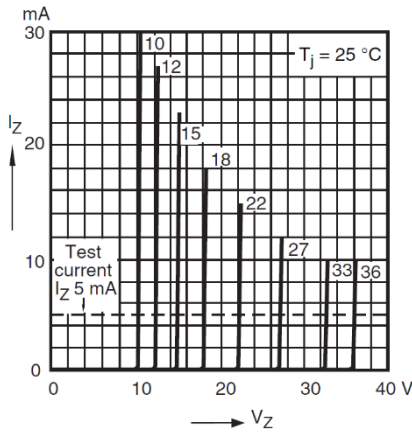

Fig. 15 - Breakdown Characteristics

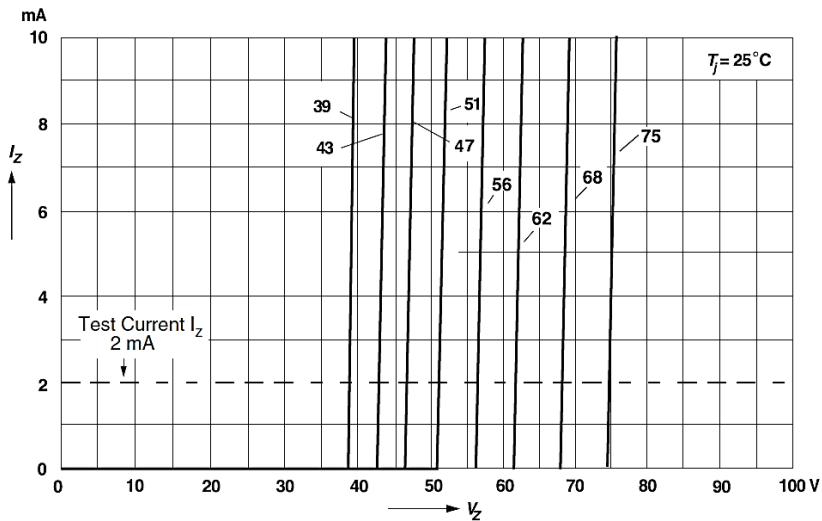
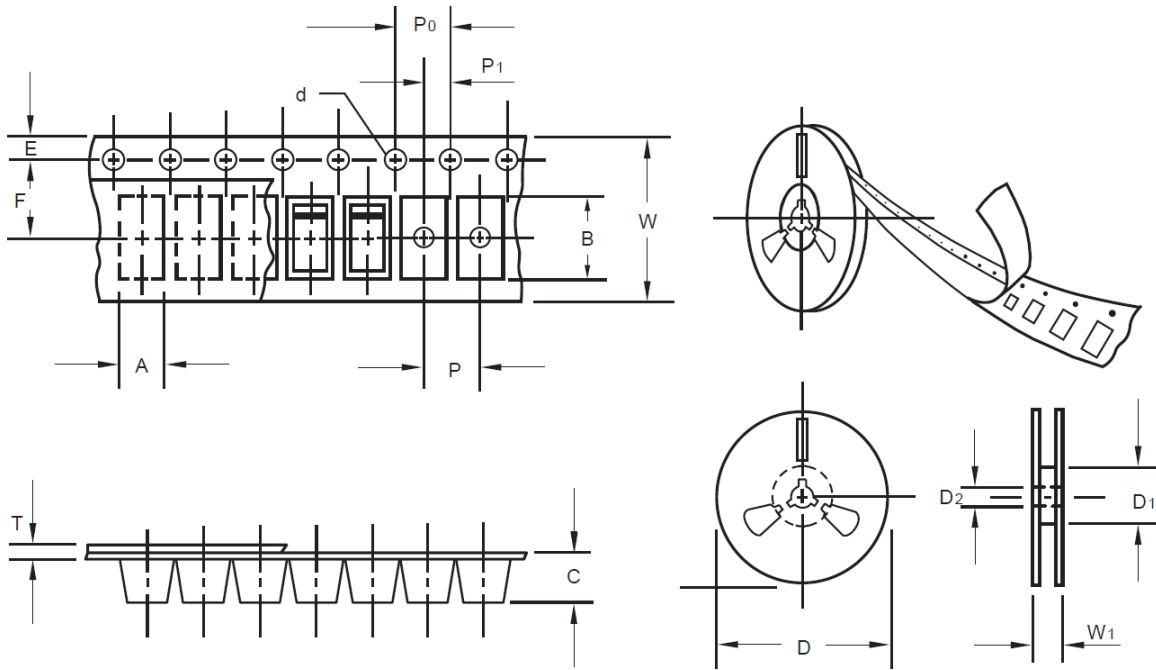

Fig. 16 - Breakdown Characteristics

**SMD ZENER DIODES SOD-323 SERIES**

**TAPE/REEL (Unit: mm)**

All Devices are packed in accordance with EIA standard RS-481-A and specifications.



| Item                      | Symbol | Tolerance | SO-323 |
|---------------------------|--------|-----------|--------|
| Carrier width             | A      | 0.1       | 2.10   |
| Carrier Length            | B      | 0.1       | 4.00   |
| Carrier Depth             | C      | 0.1       | 1.60   |
| Sprocket hole             | d      | 0.05      | 1.55   |
| 13" Reel outside diameter | -      | -         | -      |
| 13" Reel inner diameter   | -      | -         | -      |
| 7" Reel outside diameter  | D      | 2.0       | 178.00 |
| 7" Reel inner diameter    | D1     | Min.      | 50.00  |
| Feed hole diameter        | D2     | 0.5       | 13.00  |
| Sprocket hole position    | E      | 0.1       | 1.75   |
| Punch hole position       | F      | 0.1       | 3.50   |
| Punch hole pitch          | P      | 0.1       | 4.00   |
| Sprocket hole pitch       | P0     | 0.1       | 4.00   |
| Embossment center         | P1     | 0.1       | 2.00   |
| Overall tape thickness    | T      | 0.1       | 0.25   |
| Tape width                | W      | 0.3       | 8.15   |
| Reel width                | W1     | 1.0       | 10.50  |

**SMD ZENER DIODES SOD-323 SERIES**

**PACKAGE**

| Case Code | Reel Size | MPQ (pcs) | Component Spacing (mm) | Qty. Per Box (pcs) | Inner Box L*W*H (mm) | Reel Size (mm) | Carton size L*W*H (mm) | Qty. Per Carton (pcs) | G. W (kg) |
|-----------|-----------|-----------|------------------------|--------------------|----------------------|----------------|------------------------|-----------------------|-----------|
| SOD-323   | 7"        | 3,000     | -                      | 24,000             | 210*208*203          | 178            | 400*400*250            | 180,000               | 8.0       |

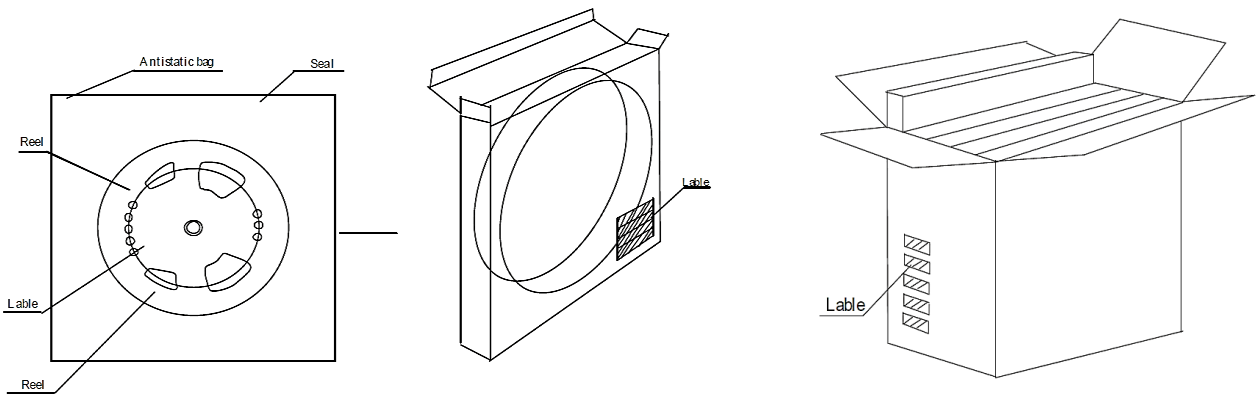

**DISCLAIMER**

NextGen Component, Inc. reserves the right to make changes to the product(s) and or information contained herein without notice. No liability is assumed as a result of their use or application. No rights under any patent accompany the sale of any such product(s) or information

## Looking for pricing, stock, or lifecycle information?

Click below to explore more details on WIN SOURCE:

- ⊖ [View BZT52C5V1S on WIN SOURCE](#)
- ⊖ [MDD Information](#)

## Optimize Your Supply Chain with WIN SOURCE Solutions

- ✓ Global Sourcing Solution
- ✓ Obsolete Management
- ✓ Cost Control Management
- ✓ Shortage Management
- ✓ Alternative Solution
- ✓ Excess Inventory Management